

# We are IntechOpen, the world's leading publisher of Open Access books Built by scientists, for scientists

4,300

Open access books available

116,000

International authors and editors

125M

Downloads

Our authors are among the

154

Countries delivered to

TOP 1%

most cited scientists

12.2%

Contributors from top 500 universities



WEB OF SCIENCE™

Selection of our books indexed in the Book Citation Index  
in Web of Science™ Core Collection (BKCI)

Interested in publishing with us?  
Contact [book.department@intechopen.com](mailto:book.department@intechopen.com)

Numbers displayed above are based on latest data collected.  
For more information visit [www.intechopen.com](http://www.intechopen.com)



## Optical Fibres Turbidimetres

Miguel A. Pérez and Rocío Muñiz  
*University of Oviedo  
(Spain)*

### 1. Introduction

This chapter presents a new type of nephelometric turbidimeter capable of really functioning on-line, avoiding any type of sampling of the liquid to be measured and, as a result, not requiring valves, pumps or any other type of electromechanical device, which results in it lasting longer and reducing maintenance. In addition, it takes advantage of the possibility of light conduction via optical fibres to avoid the electrical parts coming into contact with or close proximity to the liquid; the use of optical fibres also avoids interference, improving the Signal-to-Noise ratio and offering remote measuring.

This type of turbidimeter is for general application in the literal sense and, amongst the range of uses measuring the turbidity of both urban and industrial waste and of water for human consumption could be mentioned; however, the application is presented for measuring turbidity in the wine industry during wine-making processes, which presents added problems such as colour interference and the high interval of recordable values, which can reach levels of almost nil to over 4000 NTUs.

The chapter discusses the various possibilities for measuring turbidity that could be used, analyzing their advantages and disadvantages. An experimentally verified alternative is suggested and is discussed in detail.

### 2. Turbidity measurement

#### 2.1 Nephelometric turbidimetres

Turbidity is a parameter which quantifies the number of particles in suspension in a liquid and is of great interest in environmental monitoring (APHA-AWWA-WPOC; Harrison & Fish, 1999; ISO7027, 1990, US-EPA, 1999; Wilde & Gibs 1998) and, in several industrial sectors, such as food industry (Couto & Caldeira, 2002, 2003; OIV, 1994, 2000; Qi Xin et al., 2006). Turbidity is determined optically, illuminating the liquid to be measured with a light beam and observing the total of light scattered by the particles in suspension in that liquid: the greater the number of particles, i.e. greater turbidity, the greater the light dispersion (APHA-AWWA-WPOC; US-EPA, 1999; García et al., 2005; Mylavaganam & Jakobsen, 2001; Sadar; Honeywell). This process is usually carried out by using a light source and a sensor placed perpendicularly to the beam and so that the beam aperture angle and the angle at which the sensor is capable of reading the light do not interfere and, therefore, light does not reach the sensor directly from the emitter. The system is completed by a second light sensor

that reads the non-scattered light emitted and that crosses the liquid as shown in Fig. 1 (US-EPA, 1999; García et al., 2005).

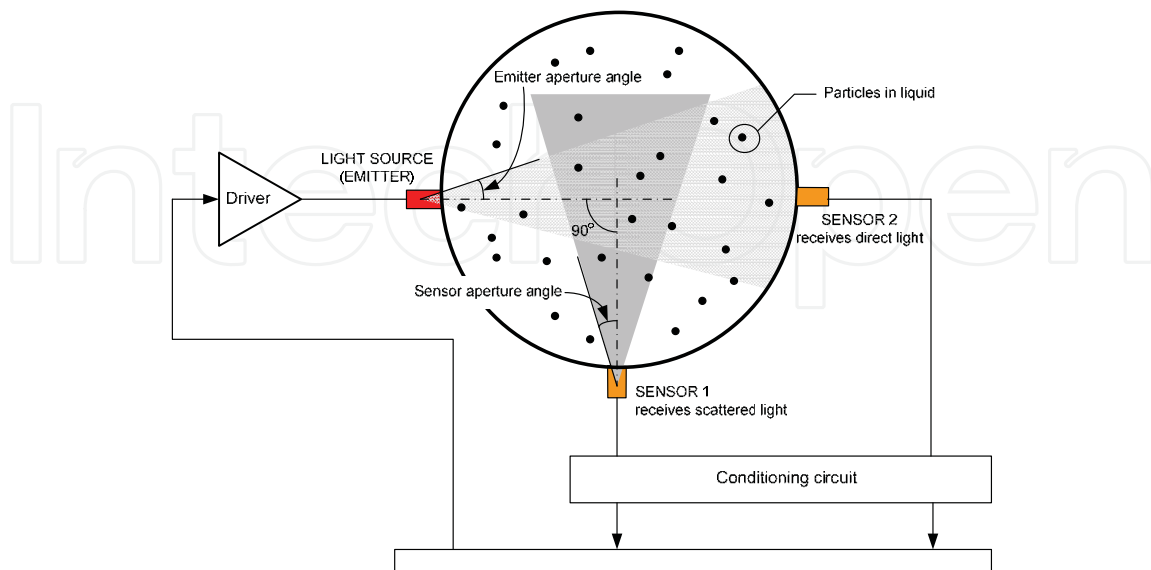

Fig. 1. Principle of operation of nephelometric turbidimeters: the light beam from emitter is scattered by particles in suspension: the scattered light - collected by sensor 1 - is proportional to the number of particles in suspension; light received by sensor 2 is used to correct any deviation of light emission level.

## 2.2 Operation problems in two-phases multi-beam turbidimeters

This basic system can be modified to improve its performance by adding a second emitter which alternates with the first one (García et al., 2006). In this case, each emitter is activated in a phase and the two sensors alternate the measurement of direct light and scattered light, eliminating the measurement uncertainty introduced by the differences between both subsystems; sensors and conditioning circuits (Fig. 2).

References can be found in the bibliography to other systems with a larger number of sensors to measure scattered light, situated at various angles - 60°, 120° or 135°- as shown in Fig. 3, in order to reduce final measurement uncertainty (APHA-AWWA-WPOC; US-EPA, 1999).

However, the latter systems with a high number of sensors are much more complex, and the presence of a larger number of devices reduces long-term reliability. The two-phase system in Fig. 2, though it may improve measurement by reducing uncertainty, presents other problems derived from the fact that both sensors must read a very intense signal - direct light - and a very weak one - scattered light, above all, at low turbidity levels - so a very high dynamic margin or two amplification circuits with very different gain are required, which would be commuted in each phase as we can see in Fig. 4 (García et al. 2005).

Whether using a system like that in Fig. 1 or either of those in Fig. 2, the scattered light depends on the quantity of light emitted, so a correct measurement must take into account the emission intensity to reduce any fluctuation in it, introducing uncertainty when measuring turbidity

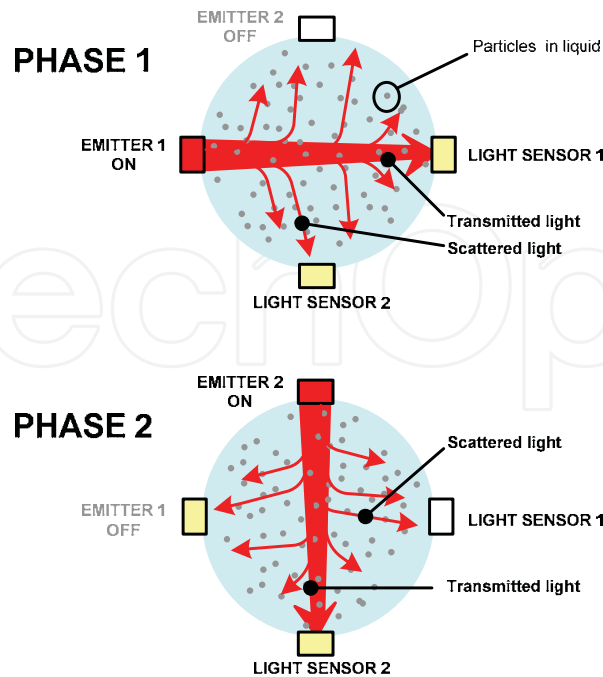

Fig. 2. Operation of four beam turbidimeter: light emission is alternated between emitters 1 and 2. During Phase 1, emitter 1 is on, sensor 1 receives the transmitted light, and sensor 2 receives scattered light; during Phase 2, the light emission is provided by emitter 2, transmitted light is received by light sensor 2, and scattered light, by light sensor 1.

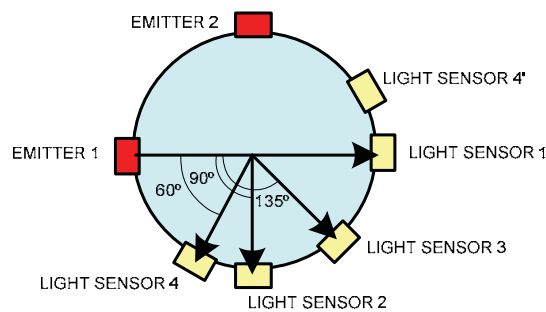

Fig. 3. Two-phases multi-beam turbidimeter.

This could be avoided by a ratiometric calculation which uses some magnitude dependent on emission light.

$$\text{Ratiometric value} = X(\text{turbidity, emission}) / Y(\text{emission}) \tag{1}$$

Unfortunately it is not easy to find that magnitude dependent only on the emission light since direct light read by the sensor depends on the turbidity so, if it is used in a ratiometric quotient, a non-linear and non-monotone expression will be obtained that produces equal values for different turbidity values, as shown in the experimental results in Fig. 5.

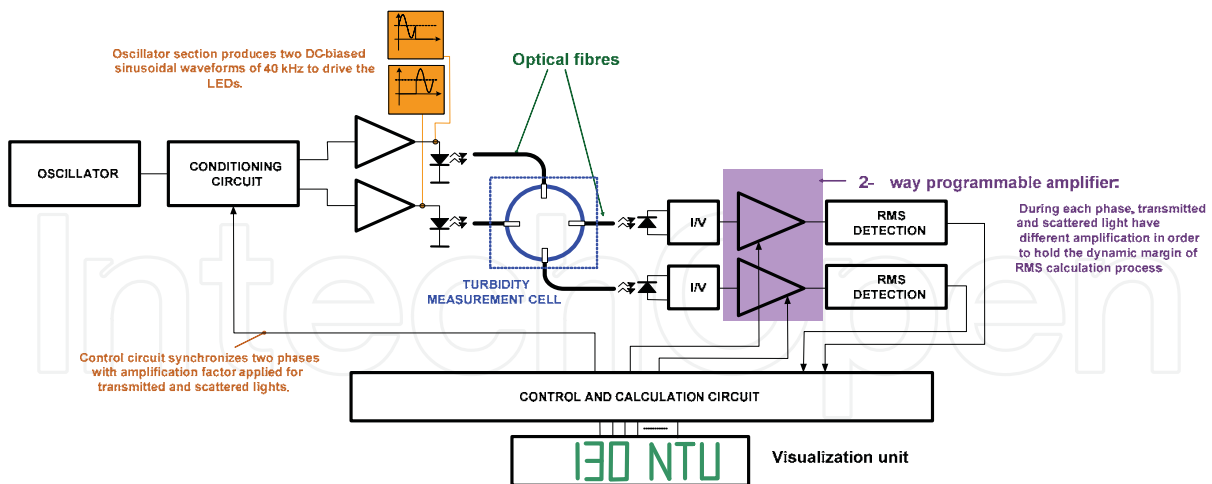

Fig. 4. Block diagram circuit for two-phases turbidimeter with optical fibres.

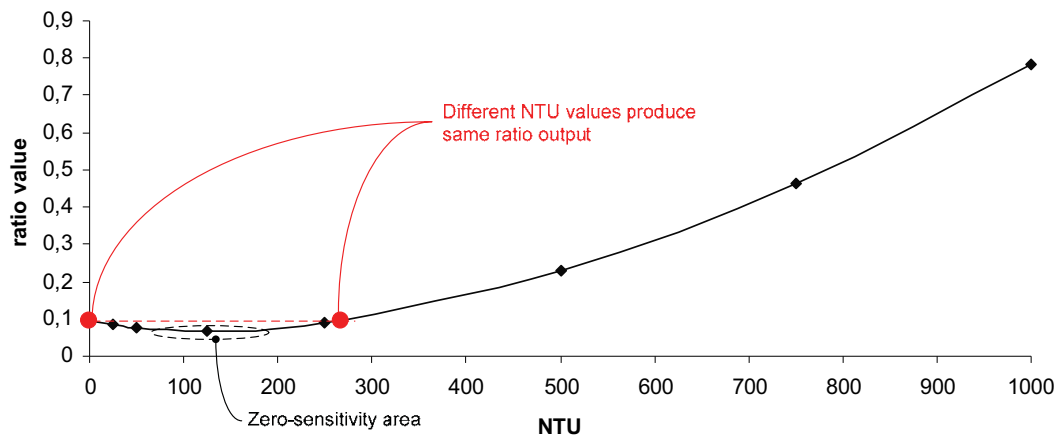

Fig. 5. The direct ratiometric measurement causes a no-defined problem due to the fact that different turbidity values produce the same output value. For example, a value is obtained with 260 NTU similar to that obtained with 0 NTU, which is completely unacceptable.

A calibration curve like the previous one would be unacceptable since it would produce uncertainty in the measurement by resolving the inverse problem and require more knowledge to help determine in which area of the curve the measurement is (Menke, 1989, Thikhonov & Arsenin, 1977). This problem shows in any configuration of the scattered light sensors and with any value of the distances between sensors, so the turbidimeters that compensate emission in this way have to work with two ranges or measurement zones and an intermediate area of zero sensitivity.

### 3. Application of optical fibres to turbidity measurement

#### 3.1 Three-beams optical fiber turbidimeter

Commercial sensors that can work on-line function by some type of sample-taking system, like a peristaltic pump or similar which takes a fraction of liquid to the measuring cell and

then empties it (Sadar; Honeywell); in reality, they are not very different from the laboratory turbidimeters and only include some more devices that allow them to take the sample more or less automatically. As this process is not instantaneous, they cannot be classed as authentic on-line devices but rather an improvement in off-line laboratory equipment. In addition, the presence of electromechanical blocks, additional conductions, etc. increases maintenance and necessarily reduces reliability and useful life.

Here, we propose a system based on optical fibre that can be placed on the same line (conduction) on which turbidity is to be measured, without using any type of sample taking, so it is a truly on-line system which provides real-time turbidity information. In order to solve the previously described problems related to the shape of the calibration curve, the system uses a different technique which allows them to be eliminated, producing a monotone reading that increase with turbidity.

The idea on which the proposed technique is based is that of maintaining the quantity of light reaching sensor 2 in Fig. 1 constant, regardless of liquid turbidity. To do this, the value read by sensor 2 is feedback and the light emitted by the source is thus adjusted.

A regulator designed to guarantee the stability of the system and the best performance completes the system. As the objective is to obtain zero errors permanently, the most appropriate regulator for this case is a PI-type one. In this way the quantity of light received has not dependence on turbidity or any disturbance, amongst which the following can be mentioned:

- Ageing of the emission source.
- Warming-up processes of the emission source when starting up the system.
- General disturbances produced by the temperature.
- Disturbance caused by the liquid absorbing light, which can be a critical factor in coloured liquids, above all when working with sensitive wavelengths.

In this way the direct light is constant and its dispersion only depends on the quantity of particles in suspension in the liquid, that is, its turbidity, and can be read by the sensor placed at 90° to the beam.

To avoid light dispersion in the perpendicular to its path, the sensor must be placed at the shortest possible distance from the measurement area, but without it "directly seeing" the emission from the source. Fig. 6 shows this system. The proposed measuring system is a three-beam nephelometric turbidimeter similar in concept to that initially proposed in Fig. 1, but with a feedback of direct light in order to guarantee that it remains constant.

The turbidimeter proposed in Fig. 6 has been used to verify overall operation. The practical aspects of its construction follow.

### 3.2 Designing a prototype

This system can work with any type of light source, as feedback of the direct signal picked up by the sensor compensates for the possible disturbances that colour would introduce due to absorption phenomena. However, to reduce the effort of the regulator, infra-red light has been chosen as it has a large number of possible emitters and sensors, which simplifies its use. In this particular case the devices listed in Table 1 have been used as emitters and receptors.

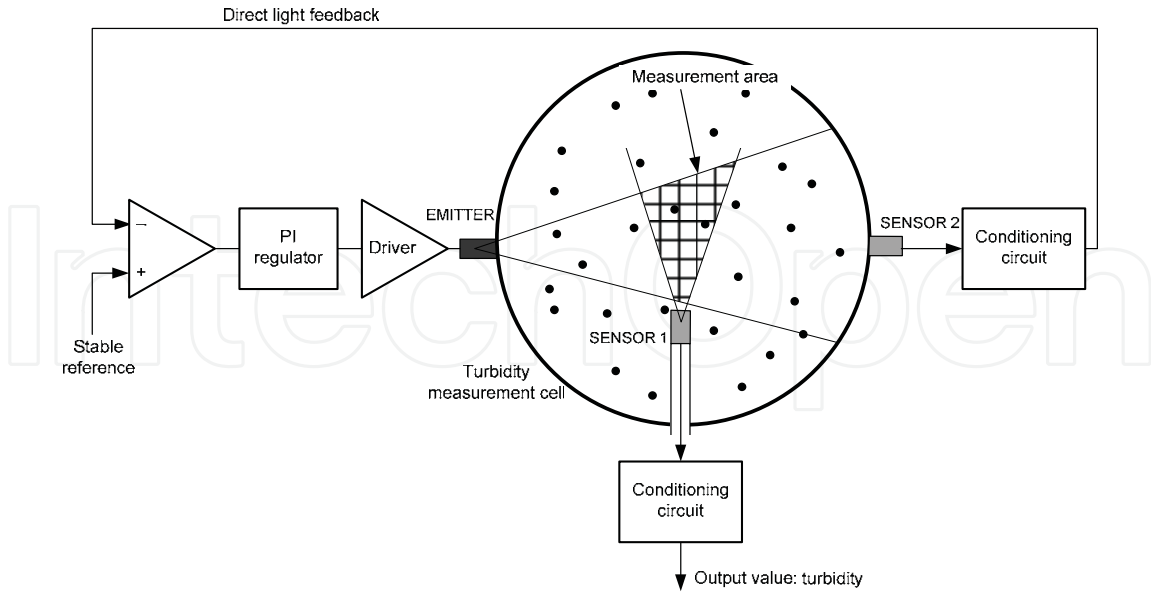

Fig. 6. Three-beam feedback turbidimeter. The sensor 1 conditioning circuit output contains the turbidity information.

Device	Spectral characteristics		
	Peak	Bandwidth	
LED L7758	850 nm	50 nm	$I_{max} = 100 \text{ mA}$
Photodiode AEPX65	820 nm	400 nm	Responsivity = 0.3 A/W

Table 1. Main characteristics of the devices used as light source and receptor.

The design of the sensor has no critical aspects except for guaranteeing its water tightness and preventing the beam of light emitted from interacting directly with the sensor placed at 90°. Fig. 7 proposes a possible design corresponding to a section of stainless steel pipe 32 mm in diameter with an 8 mm wall. The three optical fibres for transporting the light are made by SunOptics, 1 m long, multifilar and of a type of quartz- borosilicate - that means conduct is optimum in the spectrum area in which the emitters and receptors work. They are finished with an M8 stainless steel screw at one end - which is connected to the measuring cell - and SMA at the other.

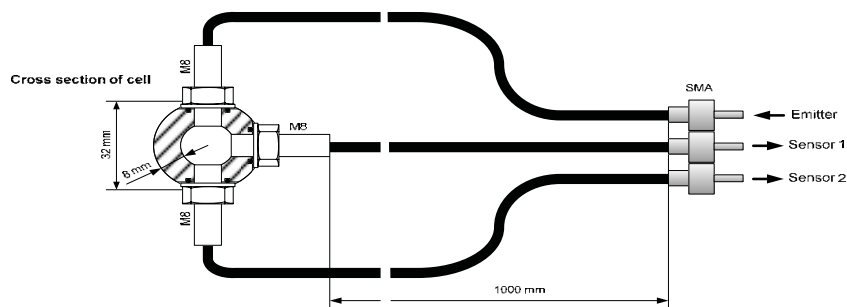

Fig. 7. Design of the turbidity measurement cell using optical fibres as light conductors.

Fig. 8 shows the measuring circuit and adds the LED excitation system, the conditioning circuits for the two receptor photodiodes and the feedback and regulator that allow the light level to be kept constant.

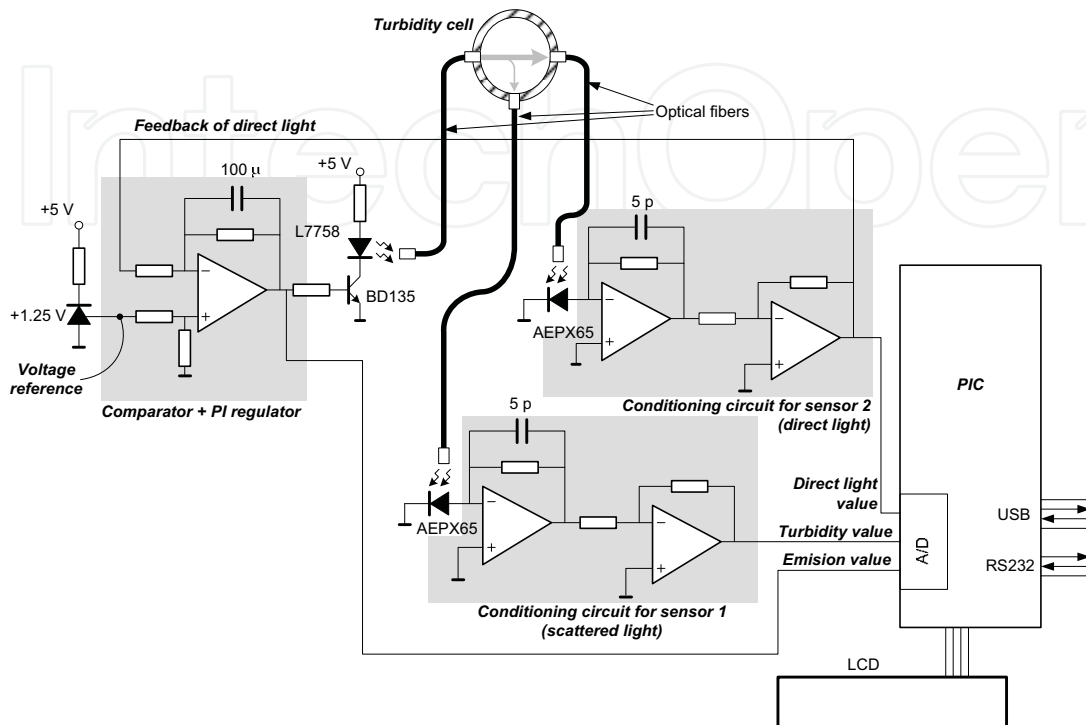

Fig. 8. Turbidimeter circuit. The calculation tasks, function test, display and distribution of the data are to be done by a PIC type low cost microcontroller.

Both the output providing information about the level of scattered light and direct light emission and reception are read by the A/D converter of a PIC-based microcontroller system for later processing, presentation and distribution of the reading obtained, thus completing the turbidimeter device. Although reading the direct light level is not necessary on the first approximation, as it is feedback and should not vary, that would only happen under ideal conditions with a perfect regulator. Under real conditions changes – though small – would occur, which could produce errors if ignored. In addition, permanent reading of those variables could be used to verify the correct functioning of the feedback loop, acting as a permanent test of the validity of the measurement obtained compared with failures of any kind or with a measurement range output.

### 3.3 Calibration curve

As the ratio between the turbidity and the scattered light measurement is not strictly linear and depends on the geometry of the sensor, the corresponding calibration curve was obtained using low uncertainty turbidity patterns from dilutions in ultra pure water of a certified 4000 NTU formacine ( $C_2H_4N_2$ ) pattern from Dinko, code 1.9779.00, prepared from Baker reference materials, codes 1114, 3371 and 4218, following the specifications listed in (APHA-AWWA-WPOC). The patterns obtained by dilution are shown in Table 2 together with their uncertainty values.



NTU	0	50	100	150	200	250	300	400	500
Uncertainty(%)	-	.05	.11	.17	.24	.3	.35	.45	.58
NTU	750	1000	1200	1400	1600	1800	2000		
Uncertainty(%)	.77	1.0	1.2	1.4	1.7	1.9	2		

Table 2. Turbidity patterns obtained by diluting a certified 4000 NTU pattern.

Under these conditions the calibration curve was obtained by measuring the values provided by the two sensors after conditioning and amplifying; the excitation value of the light emitter was also read. The graphs in Figs. 9 to 11 show all the data obtained.

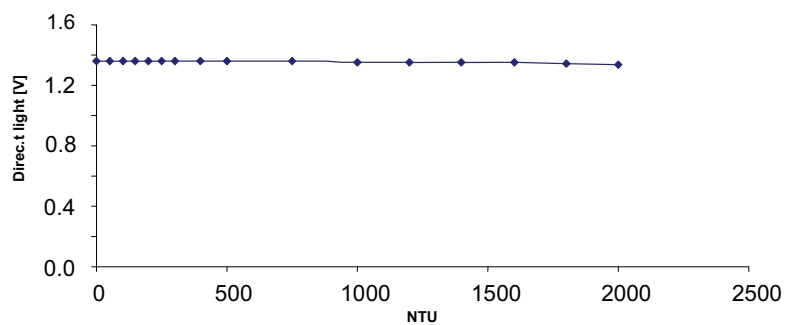

Fig. 9. Direct light as regards turbidity. Maximum variation is 1.5% over the turbidity span.

As can be seen, the direct light remains almost constant (Fig. 9) throughout the turbidity interval. This is due to the action of the regulator which conveniently raises the excitation applied to the LED (Fig. 10). The measured level of scattered light (Fig. 11) contains the turbidity information and, as can be seen, is increasingly monotone, as planned. However, although it presents quite a linear area for low turbidity, global conduct is not linear, and even, a polynomial adjustment returns a relatively high correlation coefficient, but which can be improved, as the next section shows.

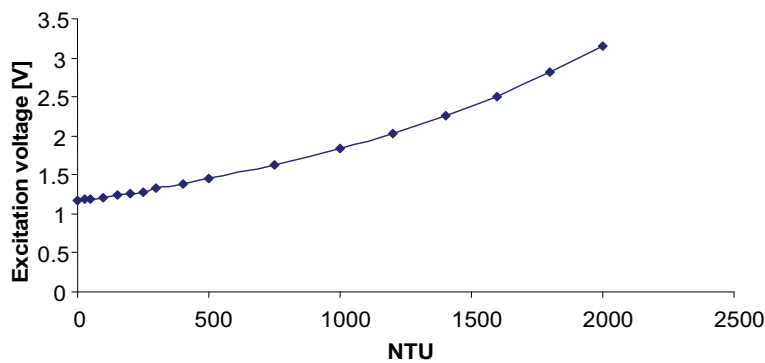

Fig. 10. Excitation signal from the emitter increasing with turbidity to maintain light constant in the direct light receptor.

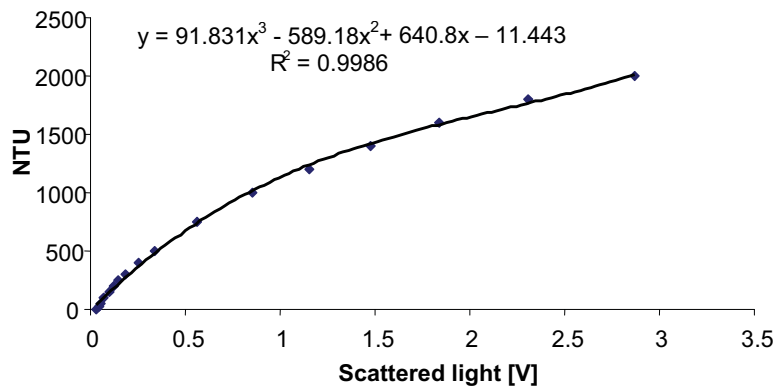

Fig. 11. Calibration curve using the signal received at the scattered light sensor to determine turbidity: the adjustment obtained is not excessively good, above all for low turbidity values.

This effect is due to the fact that the light is only guaranteed to be constant close to the receptor placed at 180° to the emission, but not in the central area, precisely the area where turbidity is measured. Fig. 12 explains this, showing the evolution in the light emission area in terms of turbidity.

To solve the problem a measurement can be made by obtaining a dimensionless ratiometric value (TRV) which eliminates the effect of the excitation light:

$$TRV = V_{scattered}/V_{excitation} \tag{2}$$

Obtaining this value of the measurement values gives the quasi-linear graph of Fig. 13, which the microcontroller will use to make the measurement. Table 3 shows the coefficients of three possible adjustments: linear and polynomial of orders 2 and 3, observing that the correlation coefficient is very high, above all in the last mentioned case.

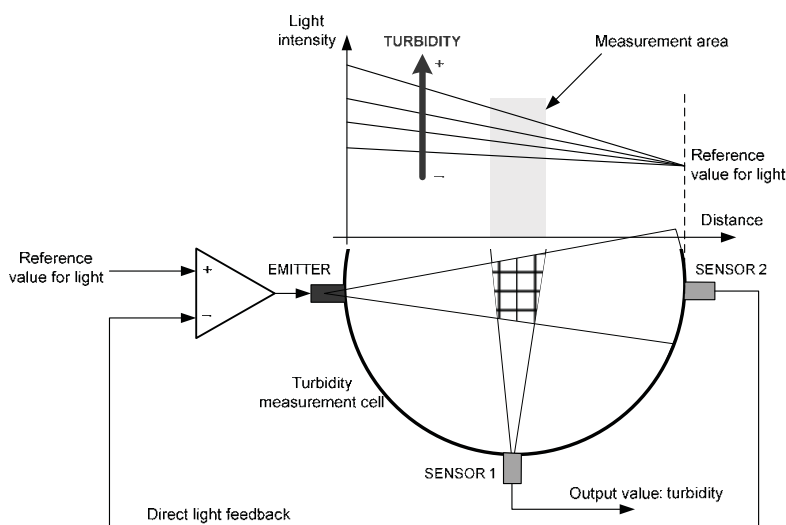

Fig. 12. The light illuminating the measurement area is not kept constant with the turbidity in spite of feedback.

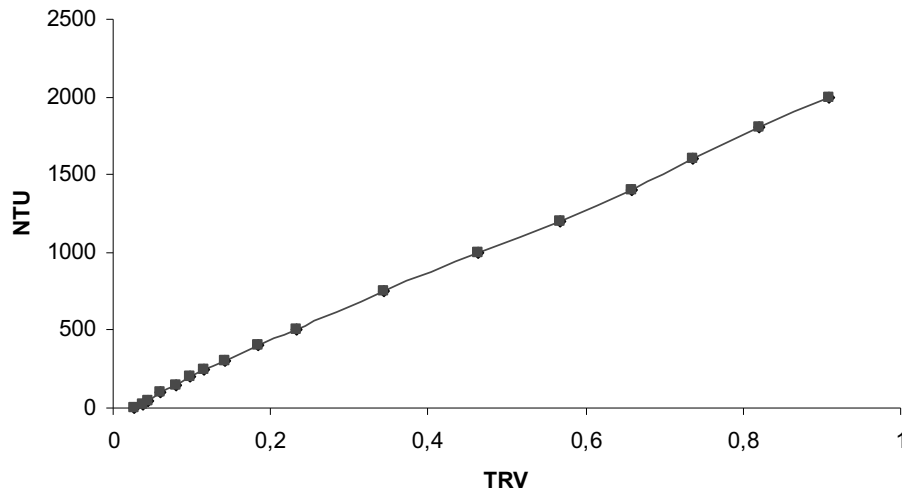

Fig. 13. Calibration curve obtained from the Turbidity Ratiometric Value (TRV). The appearance of the curve is much more linear than that of Fig. 11.

Function type	Coefficients	$R^2$
Linear	$2218.5 \cdot \text{TRV} - 30.378$	0.9992
2nd order	$-25.772 \cdot \text{TRV}^2 + 2240.6 \cdot \text{TRV} + 32.587$	0.9982
3rd order	$1035.9 \cdot \text{TRV}^3 + 1440.0 \cdot \text{TRV}^2 + 2735.7 \cdot \text{TRV} + 63.186$	0.9998

Table 3. Approximations obtained by least squares for the calibration curve of Fig. 13. A linear approximation produces acceptable behaviour, although that of the third order is somewhat better.

The complexity of the calculation software on passing from a linear approximation to a polynomial one is not significant, nor are the mathematical errors produced very different, so the most complex approximation that provides the highest veracity level has been chosen.

### 3.4 Experimental results

The system, designed as described in detail in the previous section, has been extensively checked, verifying that it works in the different measurement areas for which it was designed, using turbidity patterns obtained by dilution, as shown in Table 2. The results are shown in the graphs in Fig. 14, observing that there is an excellent ratio between the pattern value and that provided by the system (Fig. 14a) which is shown with a maximum error below 1% over the whole measuring range (Fig. 14b).

## 4. Application of optical fibre turbidimeters

### 4.1 Environmental measurements

Environmental measurements in water includes a lot of parameters such as DO (Dissolved Oxygen), COD (Chemical Oxygen Demand), BOD (Biological Oxygen Demand),

contaminants concentration (heavy metals, tens active substances, pesticides...) and, of course turbidity as a indicator of the number of particles in suspension.

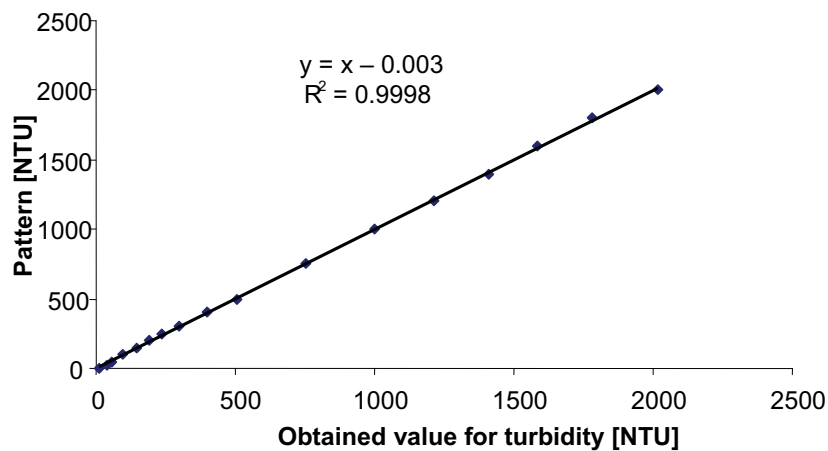

(a)

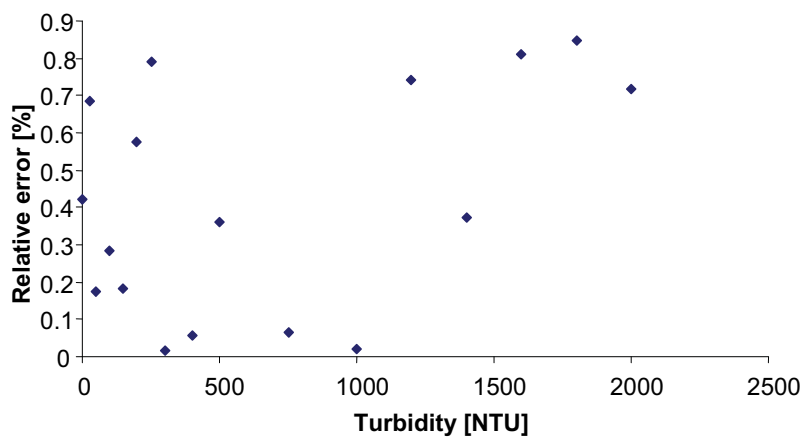

(b)

Fig. 14. (a) Turbidity obtained by the system vs. the pattern turbidity values; (b) relative error of the measuring system which does not exceed 1% in measurement span.

These measurements are carried out in monitoring process of continental water (rivers and lakes) and in sea water, and – of course – in drinkable water, disposal water and in the output of water treatment plants. In all these cases, water turbidity is one of most important parameter to define the quality and/or contamination level of each case.

Turbidity measurement in environmental applications is a special case because we must take into account some measurement conditions:

- A multi-position measurement is very usual to obtain a complete knowledge of contamination level in large volumes of water such as lakes or rivers.

- In most of cases, a remote measurement becomes necessary due to long distances between measurement point and processing unit.
- Turbidity measurement is carried out under external (ambient) light perturbations.

The use of optical fibres provides a good solution for the first and second conditions, but the third one needs an additional treatment.

The light levels used always in all previous Figures correspond to continuous (DC) values, so there is a certain risk of interference from exterior sources of light which could affect the measuring cell. This is a minor problem which occurs in few applications and which, in any case, could be solved without any great difficulty. However, if this interference becomes annoying, an AC signal, which could be filtered with a band pass filter, can be used, almost completely eliminating the external interference. The operation of the system must not vary as long as the frequency of the excitation signal is within the dynamic limits of the electronic system and of the emitters and receptors, which is not usually a very important limitation.

To verify it, a 10 kHz sinusoidal waveform on a bias level has been used as a reference signal for the system. Three experiments have been carried out under these conditions:

- Completely closed sensor without outside light affecting it.
- Sensor exposed to ambient fluorescent light with oscillations at 100 Hz.
- Sensor exposed to ambient light under indoor conditions plus a 60W incandescent light 0.3 m away from the sensor.

The values obtained are similar to those obtained continuously, due to the fact that the regulator acts correctly, compensating for the outside disturbance. The graph in Fig. 15 shows the results of this experiment with a much reduced effect from the outside disturbance. As we can see in Fig. 15, the three graphs obtained according to turbidity do not present important variations when the sensor does not receive any type of light, on being subjected to ambient illumination of fluorescent origin (100 Hz) or to close intense light.

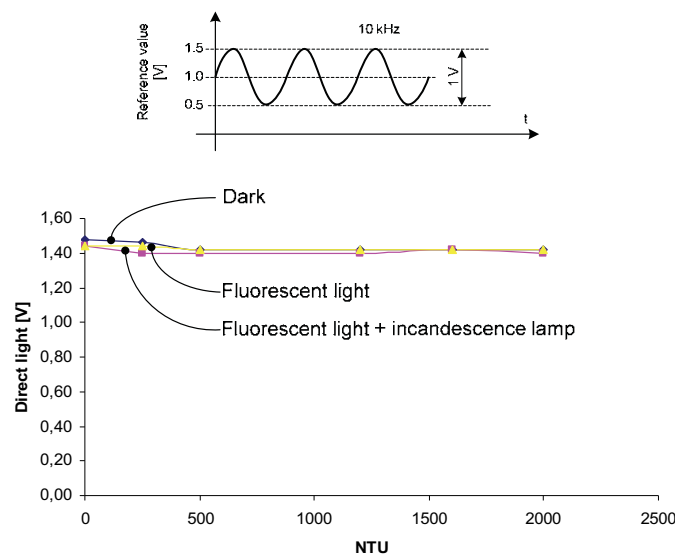

Fig. 15. Above, waveform used as a reference which consists of a 10 kHz sinusoidal, 0.5 V amplitude with a 1 V DC-bias. Below, amplitude of the signal received by the direct light sensor after amplification.

Therefore, whether working with continuous or alternating excitation the behaviour of the turbidimeter is very similar, choosing the latter if ambient light disturbances from outside are foreseeable.

#### 4.2 Measurement of turbidity in food and related industries

Turbidity is an important parameter in food related industries because they use drinkable water. In those cases, turbidity measurement is quite similar to environmental cases, but in some special industries, the turbidity measurement process presents some problems.

In the particular case of the wine industry, turbidity is a basic control parameter during wine-making and of quality in the finished product. In addition, turbidity is related to the fermentation kinetic as it presents similar conduct to CO<sub>2</sub> release velocity (Colombre, Malherbe & Sablyrolles, 2005) which indicates the fermentation activity in the unfermented grape juice because it is linked to the growth of yeast and the increased production of fermentation gasses. Turbidity is usually very low for finished wine, in most cases below 1 or 2 NTUs but, during the wine-making processes, the values may exceed 2000 NTUs, a very wide measuring range. As an example, Fig. 16 shows the evolution of turbidity during a wine-making process in which these limits are exceeded.

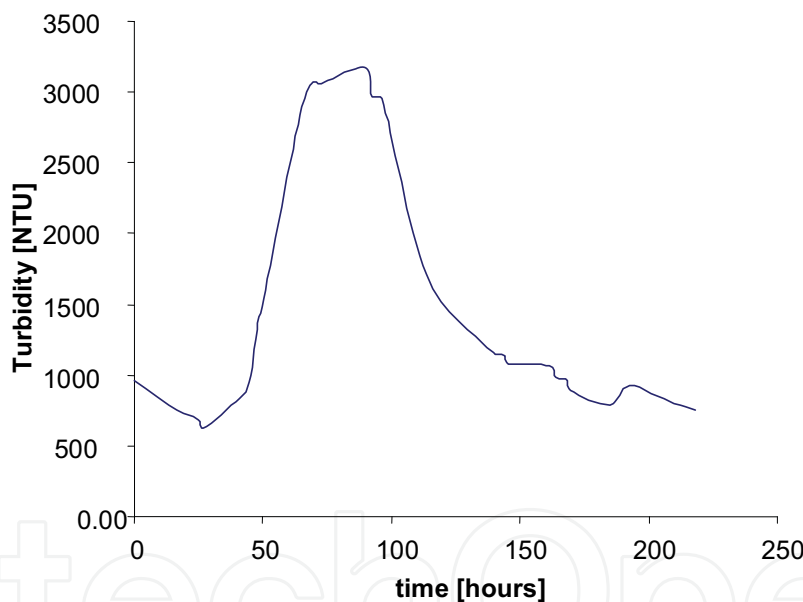

Fig. 16. Evolution of turbidity during a wine-making process lasting 10 days. This corresponds to a fermentation using tempranillo grapes

The application of the system to the wine industry for on-line measurement of turbidity during wine-making presents some disadvantages a priori:

- The presence of colour, which can produce light absorption phenomena.
- The presence of bubbles, which can modify measurements because they act by dispersing light, as do particles in suspension.

The first problem has little effect on measuring, since absorption in the infra-red area worked with is similar for different red, white and rosé wines, according to the tests carried out which appear in Table 4. The small differences recorded among finished wines made

from various grapes and with turbidity below 2 NTU, are compensated for without any difficulty by the regulation system to maintain the light level constant.

The problem of the gas bubbles is more complex to solve and presents difficulties for any type of turbidimeter which is used during wine-making, because fermentation produces a considerable amount of CO<sub>2</sub> and consequently of bubbles which cause light dispersion and an unreal rise in turbidity measurement values. In order to solve this problem, the measuring area can be pressurised by permanent derivation of the fluid without any major operation problems or losing sensor features as regards truly on-line measuring capacity. In the same way statistical treatment of the data eliminating the outliers solves the problem, providing real turbidity data.

#### *Red wines*

Zone	Grape type	Ageing in cask	IR absorption (in relation to ultra pure water)
Rioja	Tempranillo, Mazuelo	10 months	1%
Toro	Tinta de toro	3 months	1%
Somontano	Merlot, Cabernet Sauvignon	4 months	0.8%
Duero river	Tempranillo	-	0.9%
Navarre	Tempranillo	-	0.9%

#### *Rosé wines*

Navarre	Garnacha	-	0.2%
Catalonia	Tempranillo, Garnacha	-	0.2%
Rioja	Tempranillo	-	0.3%

#### *White wines*

Penedés	Chardonnay	20 days	negligible
Alicante	Muscat of Alexandria	-	negligible
Penedés	Parellada	-	negligible
Rueda	Verdejo	-	negligible

Table 4. Influence of the grape type on light absorption in the infra-red (AEPX 65 LED work area) in comparison with ultra pure water measured with an Ocean Optics VIS-NIR 2000 spectrophotometer. In all cases the absorption level is very low and is compensated by the feedback system without any significant effort.

## 5. Conclusions

A turbidity sensor is presented, based on a three-beam design including novelties such as the use of optical fibres for transporting the light and a feedback for the direct light – transmitted light – to guarantee constant excitation levels. The main advantages are that it works on-line without any type of sampling, its consequent low-cost and the elimination of safety and electrical risk limitations by avoiding the liquid coming into contact with or close to any voltage area.

In order to check whether it works in practice a low-cost specific prototype has been developed which works in the close infra-red and which presents optimum behaviour if a ratiometric value, the quotient between scattered and emitted light, is used as an output variable to represent turbidity. This produces a calibration curve with high linearity.

The developed prototype has been widely checked in experiments using certified patterns, obtaining excellent correlation between the real values and those provided by the equipment, the error remaining limited to below 1% throughout the measurement range. The effect of possible luminous type exterior disturbances has also been checked, and, if they exist, an elimination technique using biased sine type signals instead of DC signals has been proposed as a reference.

The use of turbidimeters based on the work principle described has an application in different fields, such as environmental measurements – urban or industrial waste water – or in industry itself as part of production processes. In this sense its application in measuring turbidity in wine-making processes, where it is significant, can be highlighted. In these cases the measurement range is very wide and colour can appear as an important measurement disturbance. For this case, behaviour with a large number of wines of varied origin and grape types has been checked, observing that the system is capable of compensating for the small variations in absorption that they cause in the infra-red, guaranteeing functioning truly independent of colour.

## 6. References

- APHA-AWWA-WPOC "Standards methods of Water Wastewater", APHA-AWWA-WPOC F, Ed. 16 and 17.
- Colombre, S., Malherbe, S., Sablryrolles J.M. (2005) "Modelling alcoholic fermentation in enological conditions: feasibility and interest", *Ann. J. Enol. Vitc.* 56:3
- Couto, L.M. & Caldeira, M.A. (2002) "Port-wine spectral monitoring" *Spectroscopy Europe* 14/5, pp. 22-27.
- Couto, L.M. & Caldeira, M.A. (2003) "Port wine spectronephelometry" *Optics and Laser* 25 Ed. Elsevier pp. 491-496.
- García, A. et al, (2005) "A New Design of Low-Cost Four-Beam Turbidimeter by Using Optical Fibers", *Proceedings of IEEE-IMTC'05, Canada.*
- Harrison D. & Fisch M., (1999) "Measurement, Instrumentation and sensors – Turbidity Measurement", CRC & IEEE Press.
- Honeywell, "Turbidity sensors", <http://content.honeywell.com>
- ISO 7027 (1990), Water quality, International Standard,
- Menke W. (1989) "Geophysical data analysis: discrete inverse theory", Academic Press, 1989.
- Mylvaganam S. & Jakobsen T., (2001) "Turbidity sensor for under water applications", Aanderaa Instruments Inc Press.
- OIV (2000) "Wine turbidity, Resolution OENO 4/2000".
- OIV, (1994) "Compendium of International Methods for Spirits, Alcohols and Aromatic Fractions in Beverages. Turbidity – Nephelometric Analysis Method".
- Qi Xin, Hou Zhi Ling, Tian Jian Long & Yu Zhu (2006) "The rapid determination of fat and protein content in fresh raw milk using the laser light scattering technology", *Optics and Lasers in Engineering*, 44, pp.858-869.



- Sadar M., "Turbidity Standards" Technical information series, Booklet No.12, <http://www.aquatrend.com/downloads/Lit/PDF/Whitepapers/7045.pdf>
- Thikhonov, A.N. & Arsenin V.Y. (1977) "Solutions of ill posed problems", Winston/Wiley, New York, 1977.
- United States Environmental Protection Agency. Office of water. (1999) "Guidance Manual for Compliance with the Interim Enhanced Surface Water Treatment Rule: Turbidity Provisions".
- Wilde F.D. & Gibs J. (1998) "Turbidity", U.S. Geological Survey TWRI Book 9, No. 4, chapter 6.7.



## **Optical Fiber New Developments**

Edited by Christophe Lethien

ISBN 978-953-7619-50-3

Hard cover, 586 pages

**Publisher** InTech

**Published online** 01, December, 2009

**Published in print edition** December, 2009

The optical fibre technology is one of the hot topics developed in the beginning of the 21st century and could substantially benefit applications dealing with lighting, sensing and communication systems. Many improvements have been made in the past years to reduce the fibre attenuation and to improve the fibre performance. Nowadays, new applications have been developed over the scientific community and this book fits this paradigm. It summarizes the current status of know-how in optical fibre applications and represents a further source of information dealing with two main topics: the development of fibre optics sensors, and the application of optical fibre for telecommunication systems.

### **How to reference**

In order to correctly reference this scholarly work, feel free to copy and paste the following:

Miguel A. Perez and Rocio Muniz (2009). Optical Fibres Turbidimetres, Optical Fiber New Developments, Christophe Lethien (Ed.), ISBN: 978-953-7619-50-3, InTech, Available from:  
<http://www.intechopen.com/books/optical-fiber-new-developments/optical-fibres-turbidimetres>

# **INTECH**

open science | open minds

### **InTech Europe**

University Campus STeP Ri  
Slavka Krautzeka 83/A  
51000 Rijeka, Croatia  
Phone: +385 (51) 770 447  
Fax: +385 (51) 686 166  
[www.intechopen.com](http://www.intechopen.com)

### **InTech China**

Unit 405, Office Block, Hotel Equatorial Shanghai  
No.65, Yan An Road (West), Shanghai, 200040, China  
中国上海市延安西路65号上海国际贵都大饭店办公楼405单元  
Phone: +86-21-62489820  
Fax: +86-21-62489821

© 2009 The Author(s). Licensee IntechOpen. This chapter is distributed under the terms of the [Creative Commons Attribution-NonCommercial-ShareAlike-3.0 License](https://creativecommons.org/licenses/by-nc-sa/3.0/), which permits use, distribution and reproduction for non-commercial purposes, provided the original is properly cited and derivative works building on this content are distributed under the same license.

IntechOpen

IntechOpen