

We are IntechOpen, the world's leading publisher of Open Access books Built by scientists, for scientists

4,400

Open access books available

117,000

International authors and editors

130M

Downloads

Our authors are among the

154

Countries delivered to

TOP 1%

most cited scientists

12.2%

Contributors from top 500 universities



WEB OF SCIENCE™

Selection of our books indexed in the Book Citation Index
in Web of Science™ Core Collection (BKCI)

Interested in publishing with us?
Contact book.department@intechopen.com

Numbers displayed above are based on latest data collected.
For more information visit www.intechopen.com



Power Amplification issues related to Dynamic Spectrum Access in the Cognitive Radio Systems

J. Palicot, Y. Louët and S. Hussain
SUPELEC/IETR
France

1. Introduction

For all sorts of telecommunication systems, in order to properly transmit the information, the signal has to be amplified to cope with the channel impairments and attenuations. Hence Power Amplifier (PA) is a vital element in a telecommunication system transmission chain. However, PA is still hard to design because of the key factors related to its performance which include the emitted mask power, battery consumption (linked to power amplifier efficiency), the channel propagation attenuation (linked to power amplifier gain), and the carrier-to-intermodulation ratio requirements (linked to power amplifier linearity). The design problem of PA is exacerbated due to the conflicting parameters of linearity and efficiency: the efficiency is the maximum near the saturation point, the point where non-linear effects are most severe.

In parallel to the PA non-linearity problem, the ever-increasing demands of high data rate transmission, bandwidth improvement, and the greater spectral efficiency have resulted in the migration of modulation schemes from single carrier to multi carrier. This trend has increased the signal power fluctuations by a great extent, a feature generally characterized by the term Peak-to-Average Power Ratio (PAPR). Consequently the efficient power amplification of multi carrier signals in the absence of any special processing induces severe impairments, the well known non-linear distortions. Hence turns up the problem of efficient power amplification of large envelope signals.

This chapter will discuss this problem in the context of Cognitive Radio (CR) systems. Software Radio (SWR), being the enabling technology of CR systems, inherits very high PAPR because of the multi-carrier nature of its signals. Moreover, as a consequence of Dynamic Spectrum Access (DSA), this high PAPR will be modified in real time. We will highlight the importance of this phenomenon and propose how to deal with this new situation. We explain how the PAPR could be considered as a sensor in the Cognitive Radio context during DSA process. Then we will propose and explain a frequency view of this sensor metric which could be of great interest to visualize the problem of PAPR modifications over DSA.

2. A brief historical note on the problem

PA has been considered as a very important transmitter component since long. So as the problem of PA non linear distortion is not new and has been extensively studied in past for different communication systems. For example,

- For satellite transmission, Traveling Wave Tube (TWT) amplifier is used and its non linear problems are discussed during 80's and 90's (Bremenson et al., 1980, Steck & Pham, 1987).
- For multi carriers systems the problem is studied extensively during 90's and 2000's (Han & Lee, 2005).
- Recently, for SWR system a European project, TRUST, highlights this issue (Macleod et al., 2000).
- Also, for Multiple-Input Multiple-Output (MIMO) systems the problem of PA non linearity is discussed (Lee et al., 2005, Tam et al., 2005).

This chapter deals with the PA non linearity problem in the context of CR systems where DSA can enhance this non linearity issue.

3. High Power Amplifier Characteristics

There exist several non-linear devices in a telecommunication transmission chain like Digital to Analog (DAC) converters, High Power Amplifiers (HPA). Transmitters employ HPA in order to send signals in the free space with sufficient power to counter channel fading. HPA being a non linear device causes in and out of band distortions, inter modulations and consequently Bit Error Rate (BER) degradation when operated in the non linear region. The obvious solution would be to "back off" the signal to get it operated in the linear amplifier region but this is accompanied by considerable PA efficiency penalty. Low PA efficiency means increased battery consumption which is an important issue especially for handset terminals. The other solution would be the linearization of the amplifier which faces amplifier design constraints problem (Kenington, 2000). Below we present HPA characteristics to highlight the non linearity issue.

3.1 Non linear gain characteristics

Mainly two types of HPAs are used in communications systems, Travelling Waves Tube mainly for satellite transmission and Solid State Power Amplifier (SSPA) commonly used in terrestrial transmissions and particularly in cellular systems for the handsets. Both the types of HPA present input and output amplitude and phase non-linear characteristics. The classical gain characteristics of SSPA and TWTA (TWT Amplifier) amplifiers are illustrated in the following curves:

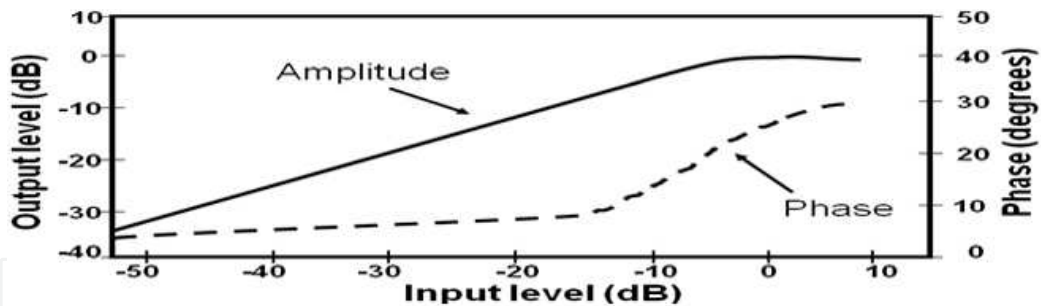

Fig. 1. Amplitude and Phase characteristics of an SSPA power amplifier

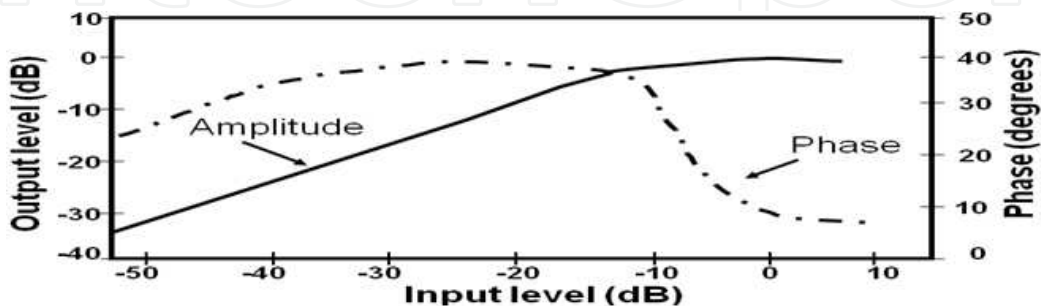

Fig. 2. Amplitude and Phase characteristics of a TWTA power amplifier

The relation between amplifier input and output amplitude is represented by Amplitude /Amplitude (AM/AM) curve while Amplitude/Phase (AM/PM) curve describes the phase shift with the input variation. The AM/AM curve can be divided into three regions.

- **Linear Zone:** In this zone, HPA has approximately a linear behaviour i-e the output power is proportional to the input power. This proportionality is the gain of the amplifier without any degradation of the signal at output.
- **Compression Zone:** In this zone the proportionality between the input power and the output power no longer exists and signals perturbations appear. One very important point in this region is 1 dB compression point which is the point at which there is 1 dB difference between ideal gain curve and practical gain curve.
- **Saturation Zone:** In this zone the output power is quasi constant i-e output power is saturated denoted by P_{sat} .

It could be seen in Fig. 1 and Fig. 2 that AM/AM curves for the two types of HPAs are almost similar. But the AM/PM curves are quite different as in the case of SSPA, the phase curve is almost constant during the linear region but varies a lot for TWTA in the same region.

3.2 Efficiency characteristics

Power amplifier needs a dc source to amplify the signal. This dc value is associated to the efficiency of the amplifier. Figure.3 shows a simplified budget of the different powers associated to power amplifier.

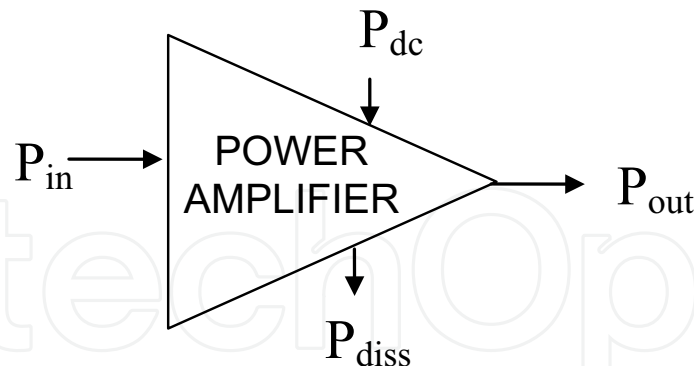

Fig. 3. Simplified power budget diagram of a power amplifier.

The power consumption budget is given by:

$$P_{in} + P_{dc} = P_{out} + P_{diss}$$

Power amplifier efficiency is the ratio between the output power and the source (dc) power. This is an important parameter as it is related to amplifier consumption which itself would be a great challenge for future communication systems. PA efficiency is given by,

$$\eta = \frac{P_{out}}{P_{dc}}$$

There is another efficiency definition, power-added efficiency, which takes into account the input power and is given by,

$$\eta_{added} = \frac{P_{out} - P_{in}}{P_{dc}}$$

3.3 Input and Output back-off

To nullify or reduce the non-linear effects, the operating point of power amplifier is backed-off. The amount of input and output back-off from 1 dB compression point or saturation point is called Input Back Off (IBO) and Output Back Off (OBO) respectively.

Let P_{in} be the signal mean input power, P_{out} mean output power, $P_{sat,out}$ saturation output power and $P_{sat,in}$ the corresponding input power as shown in Fig. 4. The IBO and OBO would then defined as,

$$IBO = \frac{P_{sat,in}}{P_{in}} \quad \text{or} \quad IBO(dB) = P_{sat,in}(dBm) - P_{in}(dBm) \quad .$$

$$OBO = \frac{P_{sat,out}}{P_{out}} \quad \text{or} \quad OBO(dB) = P_{sat,out}(dBm) - P_{out}(dBm) \quad .$$

IBO and OBO can also be defined in terms of $P_{out,1dB}$ and $P_{in,1dB}$ (Kenington, 2000) where $P_{out,1dB}$ is the output power at 1 dB compression point and $P_{in,1dB}$ is the corresponding input power.

$$IBO = \frac{P_{in,1dB}}{P_{in}} \quad \text{or} \quad IBO(dB) = P_{in,1dB}(dBm) - P_{in}(dBm) \quad .$$

$$OBO = \frac{P_{out,1dB}}{P_{out}} \quad \text{or} \quad OBO(dB) = P_{out,1dB}(dBm) - P_{out}(dBm) \quad .$$

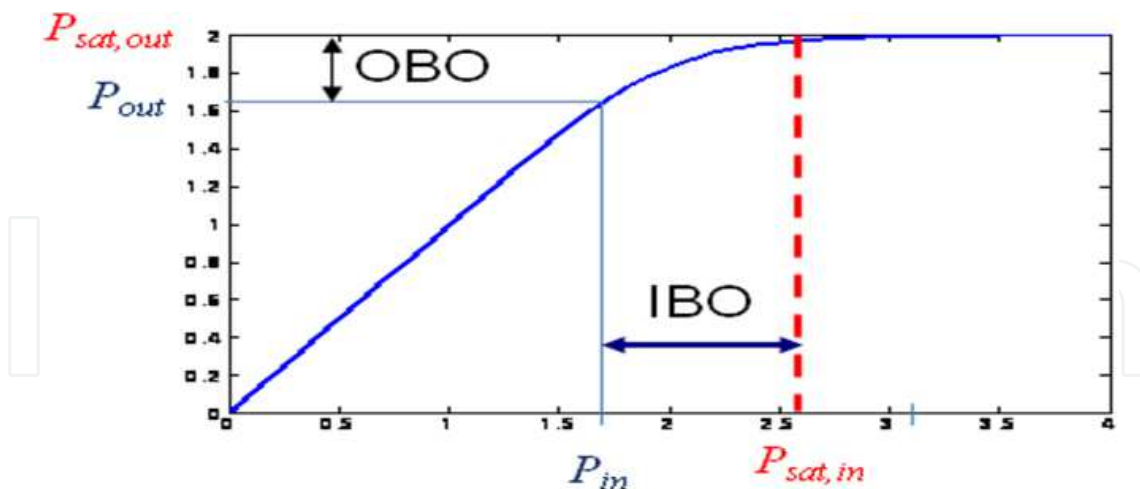

Fig. 4. Different power levels on the PA gain curve.

3.4 Carrier to Intermodulation (C/I) ratio

It is the ratio of useful carrier power level to intermodulation products power level. Normally this term is used to describe intermodulation effects in narrow band systems. C/I_n is the C/I ratio of useful power to the intermodulation product of order n .

3.5 Interception point

The n -order intercept point relates nonlinear products caused by the n^{th} order term in the nonlinearity to the linearly amplified signal. Generally 3rd order intercept point is used to relate intermodulation products to input signal. Fig. 5 depicts the Interception point concept.

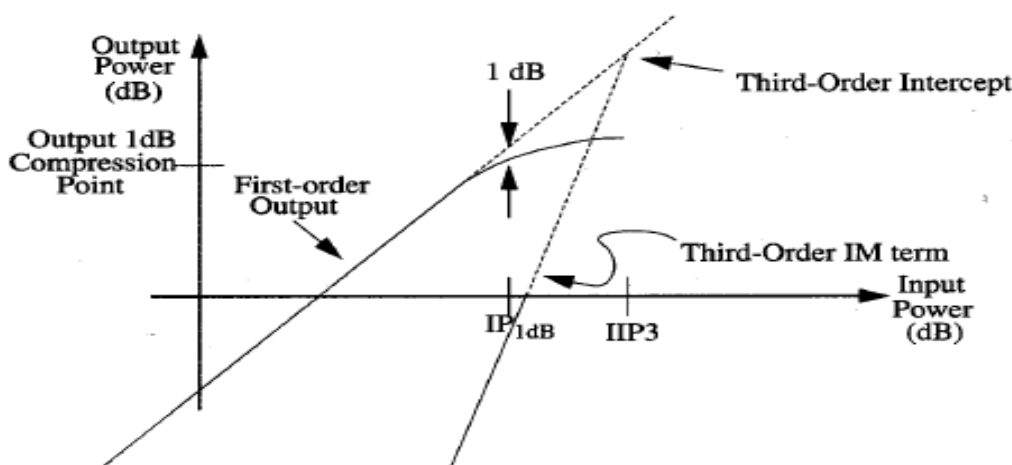

Fig. 5. Third order interception point

3.6 Memory effect

With the rapid growth of communication systems, the future systems are supposed to operate on a very large bandwidth. And HPA characteristics should be frequency

independent otherwise the performance of the amplifier shall be affected by the frequency of the signals being amplified (Soury & Ngoya, 2005). When HPA performance is dependent on frequency it is said to have 'memory'. Memory effects of an amplifier have a very important impact on the overall performances of the HPA and should not be neglected for future systems.

3.7 HPA modeling

There are several HPA models presented in literature with and without memory effect considerations. Below we shall very briefly discuss some HPA models.

3.7.1 HPA modeling without memory effect

For an input signal $S(t) = |S(t)|e^{j(\omega_c t + \varphi_c(t))}$ with $s(t) = |S(t)|\cos(\omega_c t + \varphi_c(t)) = \text{Re}\{S(t)\}$ the transmitted signal, the output signal is given by:

$$y(t) = A(|S(t)|)\cos(\omega_c t + \varphi_c(t) + \Phi(|S(t)|)),$$

where $A(|S(t)|)$ is relative to the AM/AM transfer function and $\Phi(|S(t)|)$ is relative to the AM/PM transfer function. For an ideal linear amplifier $A(|S(t)|)$ is constant as well as phase $\Phi(|S(t)|)$ independent of the input power $|S(t)|$.

The most commonly used model, mainly for TWTA was the **Saleh model** (Kenington, 2000) with,

$$A(|S(t)|) = \frac{v|S(t)|}{1 + \beta_a |S(t)|^2},$$

$$\Phi(|S(t)|) = \frac{\alpha_\phi |S(t)|}{1 + \beta_\phi |S(t)|^2},$$

and

$$A_s = \frac{1}{\sqrt{\beta_a}}$$

where v is the small signal gain and $\sqrt{\beta_a}$ is the input saturation power. The maximum

phase shift is $\Phi_\infty = \frac{\alpha_\phi}{\beta_\phi}$.

Rapp model is commonly used for SSPA in transmission systems (Kenington, 2000) with

$$A(|S(t)|) = \frac{v|S(t)|}{\left\{1 + \left[\frac{v|S(t)|}{A_0}\right]^{2p}\right\}^{\frac{1}{2p}}},$$

$$\Phi(|S(t)|) \approx 0,$$

where $A_0 = \nu A_s$ is the output saturation value, p is an integer. When p becomes large the AM/AM curve approaches the ideal transformation known as 'soft limiter', i.e. $A(|S(t)|) = \nu|S(t)|$ for $0 \leq |S(t)| \leq A_s$ and $A(|S(t)|) = \nu A_s$ for $A_s \leq |S(t)|$.

3.7.2 HPA modeling with memory effect

In practice, AM/AM and AM/PM curves are different as function of the frequency. This phenomenon should be taken into account in wideband application such as SWR. Models which take into account this frequency parameter are called models with memory. There are several models like Saleh, Bösch, Blum and Meghdadi (Kenington, 2000) which consider memory effect. Only Saleh model is presented here to give an idea.

Saleh model is given by the following 4 coefficients $\alpha_p, \beta_p, \alpha_q, \beta_q$, with the rules proposed by Saleh and illustrated by the Fig. 6.

$$\begin{aligned}
 H_p(f) &= \sqrt{\beta_p(f)} & \text{and} & & H_q(f) &= \sqrt{\beta_q(f)} \\
 P(A) &= \frac{\alpha_p(f)A}{1 + \beta_p(f)A^2} & \text{and} & & Q(A) &= \frac{\alpha_q(f)A^2}{1 + \beta_q(f)A^2} \\
 G_p(f) &= \frac{\alpha_p(f)}{\sqrt{\beta_p(f)}} & \text{and} & & G_q(f) &= \frac{\alpha_q(f)}{\beta_q(f)\sqrt{\beta_q(f)}}
 \end{aligned}$$

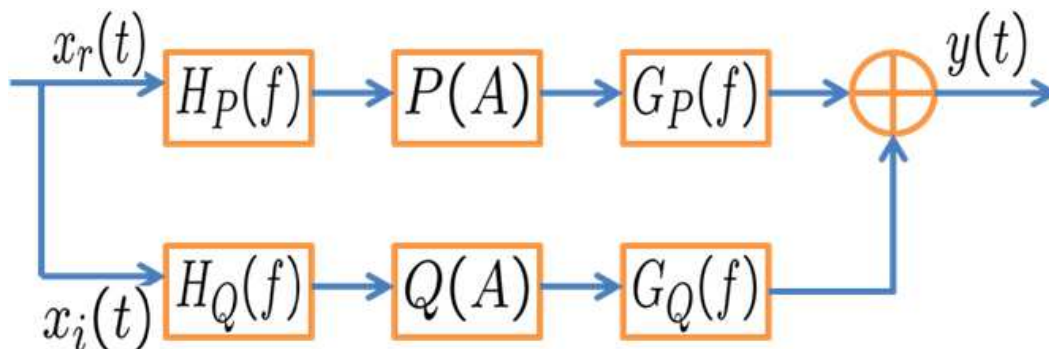

Fig. 6. Saleh model with memory effect.

4. Envelope characteristics of multi-carrier signals

There are two types of signals with respect to signal carrier frequency. First type is that of single carrier signals where the data is transferred on a single carrier frequency like in Global System for Mobile communications (GSM) where each user's data is transmitted on a particular frequency. Second type is that of multi-carrier signals where the data is transmitted over many carrier frequencies like in Orthogonal Frequency Division Multiplexing (OFDM) where the information is modulated on several carriers. The envelope characteristics of single carrier and multi-carrier signals are different from each other and in this part we shall highlight these differences.

4.1 Single carrier signals

In single carrier communication like the transmission of a Quadrature Phase Shift Keying (QPSK) or Gaussian Minimum Shift Keying (GMSK) modulated data, the information is transmitted over a single carrier frequency. Thus the power fluctuations of this signal depend upon the constellation scheme and shaping filter characteristics. For example in case of amplitude modulations like Quadrature Amplitude Modulation (QAM), more power fluctuations should be observed compared to those of phase modulations like QPSK as maximum and mean power of the symbols is the same in case of phase modulation. Also the characteristics of the shaping filter affect the signal envelope, as in case of Root Raised Cosine (RRC) filter, the envelope varies with the change in filter's roll-off factor. Fig. 7 shows the power fluctuations of QPSK modulated single carrier signal with roll-off factor of 0.22.

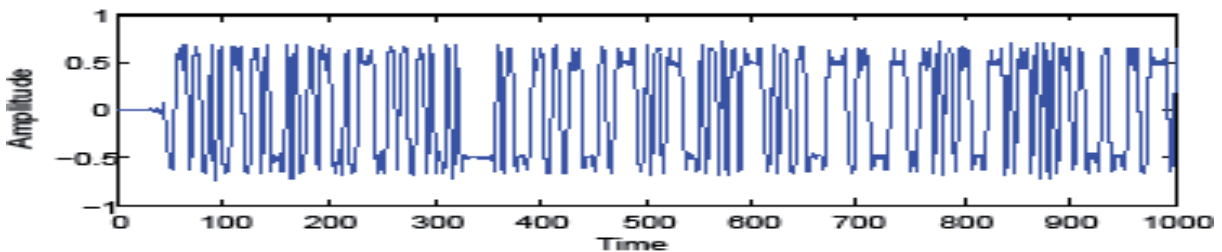

Fig. 7. Power fluctuations in single carrier signals (QPSK modulation, roll-off=0.22).

4.2 Multi-carrier signals

4.2.1 OFDM signals

In case of multi carrier communication like OFDM, a large number of sub carriers are added simultaneously to make a multi carrier signal. For example an OFDM symbol containing N sub carriers would be formed as,

$$S(t) = \sum_{j=-\infty}^{+\infty} \sum_{k=0}^{N-1} C_{j,k} g(t - jT_s) e^{2i\pi f_k t}, \quad (1)$$

where $g(\cdot)$ is the rectangular pulse of duration T_s , $C_{j,k}$ represents the complex information symbol of carrier k with $f_k = \frac{k}{T_s}$ of j^{th} OFDM symbol. For any l^{th} OFDM symbol, the baseband signal $S_l(t)$ is given by,

$$S_l(t) = \sum_{k=0}^{N-1} g(t - lT_s) C_{l,k} e^{2i\pi f_k t}, \quad (2)$$

or,

$$S_l(t) = \sum_{k=0}^{N-1} C_{l,k} e^{2i\pi f_k t}, t \in [lT_s, (l+1)T_s]. \quad (3)$$

According to the central limit theorem, when a large number of independent and identically distributed (i.i.d) random variables are added simultaneously, their distribution becomes Gaussian which means that there is a big gap between mean and maximum values. As OFDM signal can be treated like a summation of many i.i.d random variables, its distribution tends to be Gaussian following the central limit theorem which results in high power fluctuations as shown in Fig. 8.

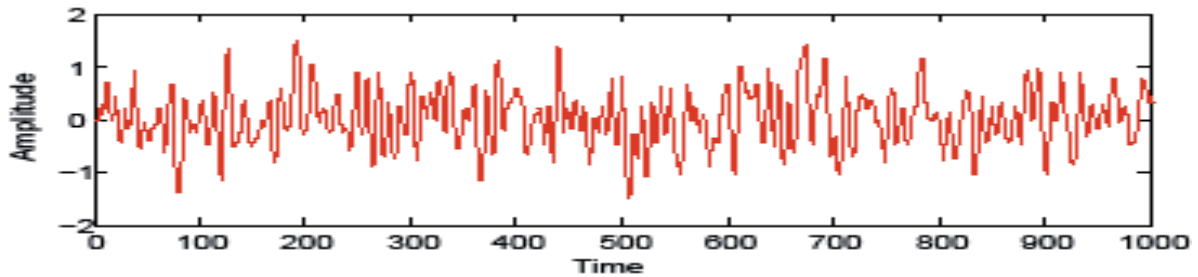

Fig. 8. Power fluctuations in multi carrier signals (N=64, QPSK Mapping).

4.2.2 Software Radio signals

SWR can be defined as a system able of modulating and demodulating any kind of signal, any time anywhere, on any network (Fasbender et al., 1999). Consequently any SWR signal $x(t)$ is a composite signal given by,

$$x(t) = \sum_{i=1}^S S_i(t), \quad (4)$$

where S is the number of standards contained in the composite SWR signal and S_i represents the i^{th} standard. Each signal $S_i(t)$ associated to a given standard of P_i carriers can be expressed as,

$$S_i(t) = \sum_{p=1}^{P_i} r_{i,p}(t) e^{2i\pi f_{i,p}t},$$

where $r_{i,p}(t)$ represents the modulated and filtered signal associated to carrier p of the standard i . In this case, $r_{i,p}(t) = fem_i(t) * m_{i,p}(c(t))$, where $m_{i,p}(c(t))$ represents the modulation relative to the carrier p and standard i and $fem_i(t)$ is the shaping filter function of standard i . Using the two aforementioned equations, a multi-standard signal can be written as,

$$x(t) = \sum_{i=1}^S \sum_{p=1}^{P_i} (fem_i(t) * m_{i,p}(c(t))) e^{2i\pi f_{i,p}t}. \quad (5)$$

As it could be seen that SWR signal is a multi-carrier signal and due to this property it demonstrates high signal fluctuations.

4.3 Peak to Average Power Ratio (PAPR)

As discussed previously that HPA is a non-linear device and to operate it in the high efficiency zone, the power fluctuations of the signal should be minimized otherwise non linear distortions would occur. These power fluctuations are described by various terms in literature but most common of all is PAPR (Peak to Average Power Ratio). It is defined as the ratio between maximum instantaneous power and mean instantaneous power. For a complex base band signal, $s(t) = s_I(t) + s_Q(t)$, PAPR would be defined as,

$$\text{PAPR}\{s(t)\} = \frac{\max_t |s(t)|^2}{\lim_{T \rightarrow \infty} \frac{1}{T} \int_0^T |s(t)|^2}. \quad (6)$$

For Radio Frequency (RF) signal with $f_0 = \frac{\omega_0}{2\pi}$ being the carrier frequency. The PAPR is defined as,

$$\text{PAPR}\{s(t)\} = \frac{\max_t |Re(s(t)e^{j\omega_0 t})|^2}{\lim_{T \rightarrow \infty} \frac{1}{T} \int_0^T |Re(s(t)e^{j\omega_0 t})|^2 dt}. \quad (7)$$

The relation between base band signal PAPR, $PAPR_{BB}$, and RF signal PAPR, $PAPR_{RF}$, is given by (Tellado-Mourelo, 1999),

$$\text{PAPR}_{RF} \text{ dB} \approx \text{PAPR}_{BB} \text{ dB} + 3 \text{ dB}. \quad (8)$$

All in all, PAPR is the term which demonstrates the variations in the peak of the signal power with respect to its mean power.

4.4 Equivalence between OFDM and SWR signals

SWR and OFDM both are multi-carrier signals and we shall try to make analogies between these two types of signals. First analytical equivalence is demonstrated and then PAPR distribution is discussed.

4.4.1 Analytical equivalence

If the carrier interspacing is constant for all standards, SWR signal will become a multicarrier signal, given by,

$$x(t) = \sum_{i=1}^S \sum_{p=1}^{P_i} r_{i,p}(t) e^{2i\pi((p-1)\Delta p)t}, \quad (9)$$

where Δp is the carrier interspacing which is supposed to be constant for all standards. Generally speaking, this condition cannot be verified because the distance between carriers is different from one standard to the other (Roland & Palicot, 2002). It varies from 25 kHz for Personal Digital Cellular (PDC) to 50 MHz for Hiperlan. When SWR signal contains more than one standard, it cannot be a 'typical' multicarrier signal. Therefore we cannot make any connection between an OFDM signal and a multi-standard SWR signal.

We suppose now a mono standard SWR signal. By definition then,

$$S_i(t) = \sum_{p=1}^{P_i} r_{i,p}(t) e^{2i\pi f_{i,p} t}, \quad i = 1, \quad (10)$$

which is equivalent to

$$S_i(t) = \sum_{p=1}^{P_i} r_{i,p}(t) e^{2i\pi((p-1)\Delta p)t}, \quad i = 1. \quad (11)$$

From an analytical point of view, Eq. 11 is formulated in the same way as equation Eq. 2 models an OFDM signal. In all other cases, an OFDM signal remains a particular case of a SWR signal.

4.4.2 Gaussian Equivalence between OFDM and SWR Signals

OFDM PAPR distribution has been discussed a lot in literature. (Ochiai & Imai, 2001) deals with PAPR distribution for OFDM signals and gives some Complementary Cumulative

Distribution Function (CCDF) upper bounds. With large oversampling factors (continuous signals) and knowing the fact that there is approximately 3 dB PAPR increase due to Radio Frequency (RF) transposition, PAPR CCDF for RF OFDM continuous signals is approximated by,

$$Pr[PAPR \geq PAPR_0] \approx 1 - e^{-\sqrt{\frac{\pi}{6}} N \sqrt{PAPR_0} e^{-PAPR_0}} \quad (12)$$

Below we prove that OFDM PAPR CCDF is similar to PAPR CCDF for multi standard SWR signals.

PAPR analysis of a multi standard SWR signal containing OFDM, MC-GMSK and MC-QPSK signal, is considered. General specifications used for each standard are same i.e. $N = 64$ carriers/subcarriers and 10^4 symbols. This analysis is done in RF conditions and is depicted in Fig. 9. First, it can be shown that all standards have almost similar PAPR CCDF, confirming Gaussian equivalence. Secondly, from a statistical point of view, as SWR signal is generated by the combination of these standards, PAPR CCDF of a SWR signal also demonstrates Gaussian distribution. In conclusion, any multiplex of carriers or standards, exhibits Gaussian distribution, independent of the modulation techniques and the carrier frequencies. From a PAPR point of view, SWR and OFDM show similar behaviors.

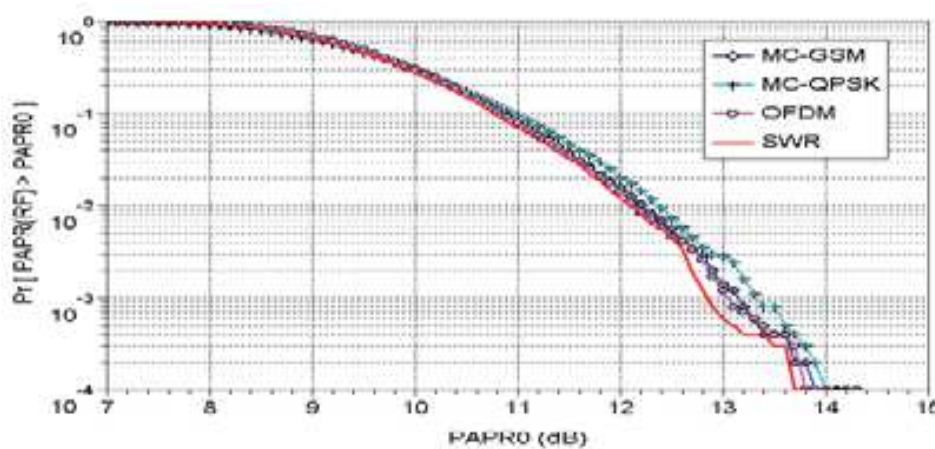

Fig. 9. PAPR distribution of a SWR signal with MC-GMSK, MC-QPSK and OFDM modulated standards in RF.

5. High Power Amplification of multi-carrier signals

As discussed previously that multi-carrier signals have high power fluctuations and these fluctuations can cause interference when the signal is amplified by HPA. We shall see some of the interference types produced on non-linear amplification.

5.1 Non linear characteristics

We can approximate any non linear amplifier $f(\cdot)$ by a polynomial function :

$$f(\cdot) = a_0 + a_1x + a_2x^2 + \dots + a_nx^n$$

For an OFDM signal $s(t)$ defined in Eq. 2, the output of power amplifier would be,

$$y = f(s(t)) = a_0 + a_1s(t) + a_2(s(t))^2 + \dots + a_n(s(t))^n$$

All the aforementioned terms generate components whose frequencies F_s are of the form,

$$F_s = \sum_{i=0}^{N-1} m_i f_i \quad (13)$$

F_s is called intermodulation product of order $\sum_{i=1}^N |m_i|$ where m_i are arbitrary integer values.

Some of the F_s frequencies fall in the useful band resulting in BER degradation while the rest fall out of the useful band causing spectrum re-growth. Some terms are defined below to better understand the intermodulation concept.

5.1.1 Adjacent Channel Power Ratio (ACPR)

In wideband systems, ACPR is used instead of C/I. ACPR is the ratio of signal power inside the useful band to the adjacent channel power.

$$ACPR_{dB} = 10 \cdot \log \frac{\int_{f_1}^{f_2} P(f) df}{\int_{f_3}^{f_4} P(f) df + \int_{f_5}^{f_6} P(f) df}$$

The different frequency positions are described in Fig.10. In (Ragusa et al., 2005), ACPR definition for multi carrier OFDM signal is given as,

$$ACPR = \frac{a_3^2 \cdot A^4 \cdot (3/8)^2 \sum_{i=1}^{N-1} u_i^2}{a_1^2 \cdot N/4}$$

where a_3 and a_1 are third and first intermodulation product coefficients, A is the normalized amplitude of the multi carrier signal, N is the number of OFDM subcarriers and $u = \frac{(N-i)(N-i+1)}{2}$.

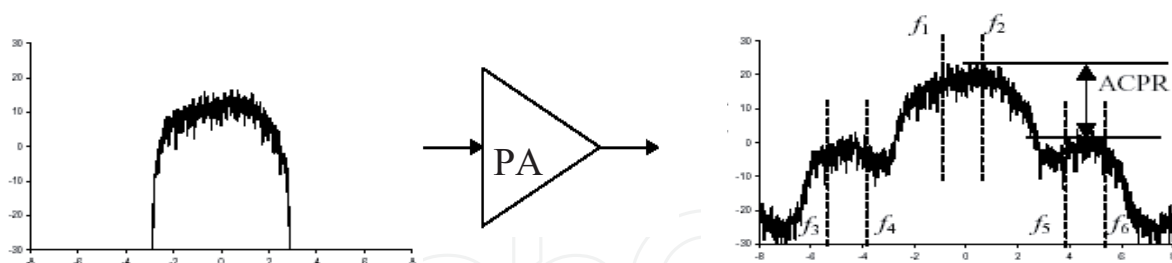

Fig. 10. Spectrum distortion after power amplification

5.1.2 EVM and MER ratios

In OFDM systems, Error Vector Magnitude (EVM) and Modulation Error Rate (MER) are the terms used to define the distortion caused by HPA in frequency and time domain respectively.

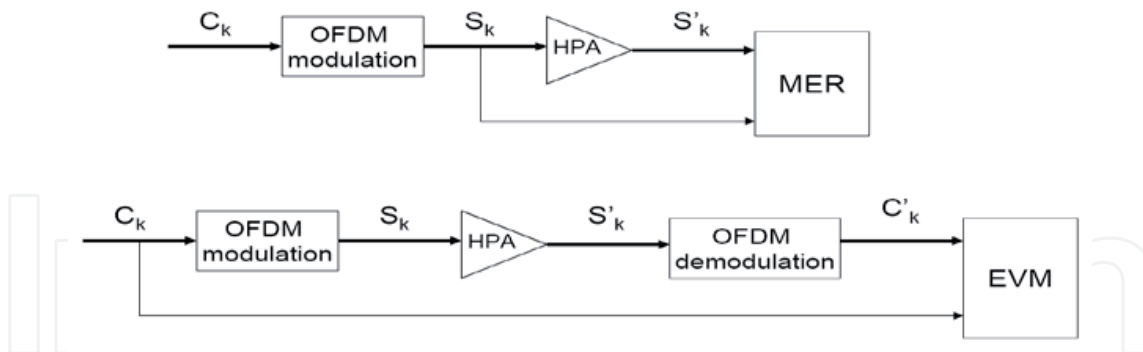

Fig. 11. MER and EVM graphical illustrations
EVM represents the influence of HPA on constellation symbols while MER describes the influence of HPA on time domain signal.

5.2 Solution to avoid HPA non-linearity

To amplify the signal at high efficiency, it needs to be driven near the saturation point. Consequently the signal should have low PAPR in order to not enter the saturation zone. Thus there was need of PAPR reduction methods and a huge number of methods have been developed since 15 years to reduce multi-carrier signal PAPR. The main reason is the success of multi-carrier modulations like OFDM as modulation and multiple access techniques in many communication standards like Digital Audio Broadcasting (DAB), Digital Video Broadcasting (DVB), Asymmetric Digital Subscriber Line (ADSL), and Wireless MAX (WiMAX) etc. A high PAPR being the drawback of OFDM, extensive research has been carried out to resolve this issue. Historically, the signal used to be backed-off and transmitted at low efficiency without PAPR reduction but with the development of technology and emerging of the new standards, battery consumption has gained a lot of attention and in turns PAPR reduction.

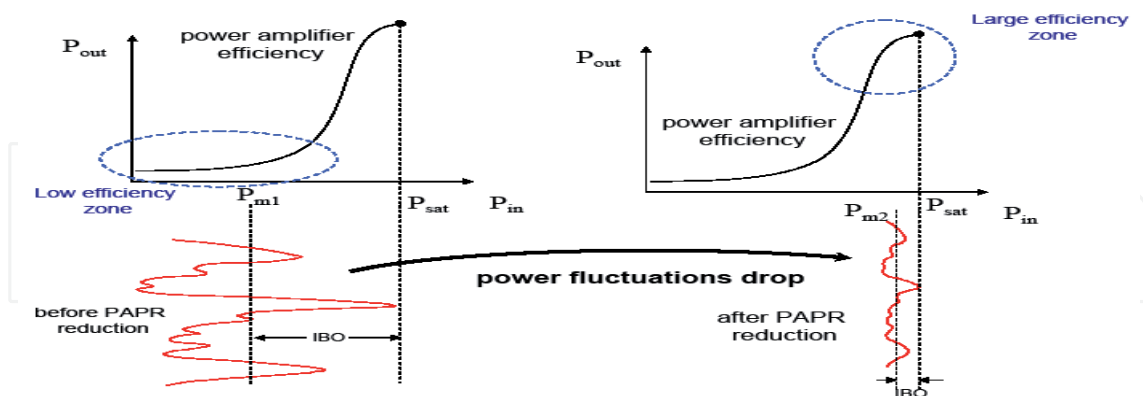

Fig. 12. High efficiency PA operation demands reduction in PAPR.

5.3 Classification of PAPR reduction methods

A classification of PAPR reduction methods has been proposed in (Louët & Palicot, 2008). It mainly concerns OFDM PAPR reduction but some methods can be applied to any modulation scheme. The idea behind this classification is to gather the methods with similar characteristics into clusters and facilitate the selection of PAPR reduction method depending

upon system requirements. There are different criteria to differentiate between existing PAPR reduction methods. Few of them are outlined below:

- Downward compatibility (DC): A method is called downward compatible if it does not imply any receiver change. When downward compatible, the PAPR reduction is implemented only at the transmitter meaning that the input data is manipulated to generate low PAPR. In that case BER needs to be investigated. Thus we have two subclasses when the method is downward compatible.

- Cluster 1 : DC without BER degradation (e-g Active Constellation Extension)
- Cluster 2 : DC with BER degradation (e-g Clipping, Peak windowing)

-If there is no DC, PAPR reduction method is implemented on both transmitter and receiver (the function and its "inverse") and theoretically BER remains unchanged. In this case data rate loss has to be investigated.

- Cluster 3 : no DC without data rate loss (e-g Pulse shaping, Tone Injection)
- Cluster 4 : no DC with data rate loss degradation (e-g Coding, Tone Reservation, Partial Transit Sequences)

These are the few examples given to illustrate the classification. The complete tree diagram of method classification is given in Fig. 13. The classification presented also refers to linearization methods which do not take into account the PAPR reduction techniques.

As already described that SWR signal is a multiplex of many modulated carriers and demonstrates a complex Gaussian distribution as OFDM thus its PAPR can be reduced using the methods developed for OFDM PAPR reduction with appropriate changes.

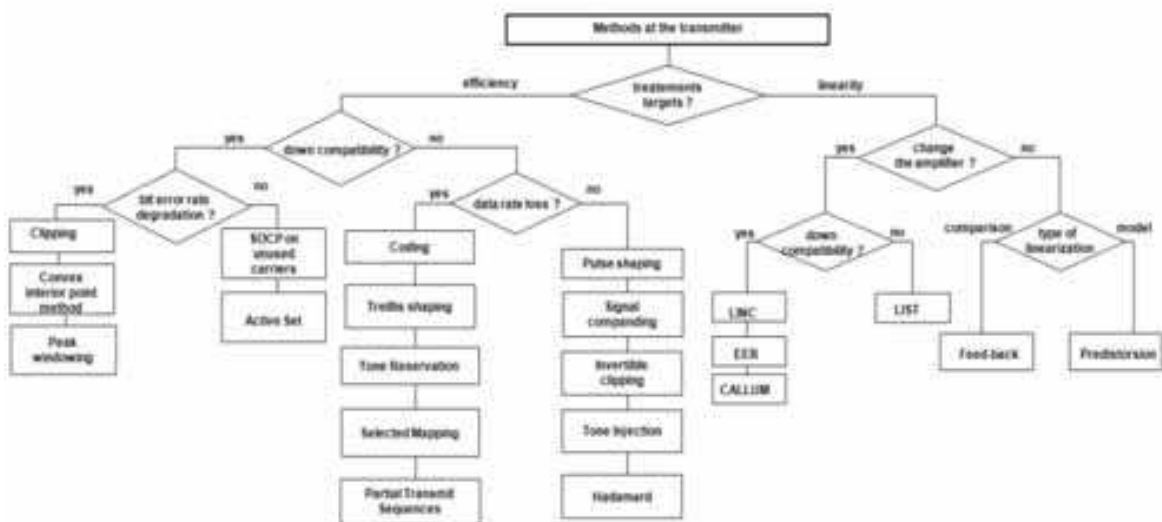

Fig. 13. Classification of PAPR reduction methods.

6. Dynamic Spectrum Access (DSA) in the Cognitive Radio context

The term "Cognitive Radio" was first coined by Mitola in 1999 who gave the following definition of CR (Mitola & Maguire, 1999),

"A radio or system that senses, and is aware of, its operational environment and can dynamically and autonomously adjust its radio operating parameters accordingly."

In other words, CR refers to self-aided and self-established reconfigurable communication system where decisions of reconfiguration are taken with the help of a set of sensors. One of these sensors is the spectrum sensor which using an opportunistic approach senses any available bandwidth and thus assists in establishing communication on suitable frequencies as suggested by Federal Communication Commission (FCC) in (FCC, 2003),

"A radio frequency transmitter/receiver that is designed to intelligently detect whether a particular segment of the radio spectrum is currently in use, and to jump into (and out of, as necessary) the temporarily-unused spectrum dynamically, without interfering with the transmissions of other authorized users."

This FCC definition is given in the context of spectrum allocation and utilization. The reason of this dynamic spectrum access is the under utilization of radio spectrum. In fact around 90% of spectrum is quiet on average and there is a great need to 'recover' the wasted spectrum resources. There are a lot of ways discussed in literature to 'recover' the spectrum (Zhao & Swami, 2007).

6.1 The inconveniences of spectrum access

In the spectrum access scenario, a CR equipment should be able to access any available bandwidth in order to fulfill its data needs. Anyhow, this spectrum access in a CR context makes sense only if the bandwidths proposed by spectrum sensor do not imply any modification to the CR equipment's Analog Front End (AFE). AFE consists of elements like filters, antennas, power amplifiers etc. The design and performance of these AFE components depend upon temporal and spectral properties of the signal, for example, antennas are designed for a specific frequency range or amplifier design is input amplitude dependent etc.

Also spectral characteristics affect temporal signal properties like signal bandwidth and constellation size relation for a specific data rate demand. Moreover, spectrum access can result in out of band distortions. This results in decrease of ACPR which degrades system performance as bit error rate increases.

Concluding, spectrum access can affect CR equipment's AFE design and also temporal signal characteristics. As CR should not modify AFE design thus spectrum should be accessed as to keep signal's temporal and spectral properties within AFE design limits. One of the AFE's elements, HPA, is of particular interest in this chapter. As HPA is susceptible to high PAPR signals, spectrum sensor should take into account the PAPR value of the emitted signal on the available bandwidth to keep the PAPR value under an acceptable level which does not imply any changes to power amplifier design. Thus the selection of suitable bandwidth should be made according to some PAPR metrics.

6.2 CR signal and its PAPR

CR uses SWR as its implementation technology. In SWR based-systems, PAPR may be quite large due to the fact that the transmitted signal is a sum of a large number of modulated carriers as discussed before. Moreover, a reconfigurable transmitter, Software Defined Radio (SDR) base station for instance, should be able to amplify single carrier and multi carrier modulation signals as well as many non-constant envelope modulation signals. Thus CR signals inherit high PAPR and this factor asks for PAPR information based spectrum access

decisions. This reason emphasizes the necessity of a frequency domain PAPR approach in a spectrum access scenario.

6.3 Spectrum access and PAPR problem

In a CR context spectrum access is about finding the free bandwidth within a standard or in between the standards for communication using an opportunistic approach as shown in Fig. 14. There are certain parameters which should be kept in mind during spectrum access for example Quality of Service (QoS), out of band interference etc. Our emphasis in this chapter is on the influence of spectrum access on PA efficiency.

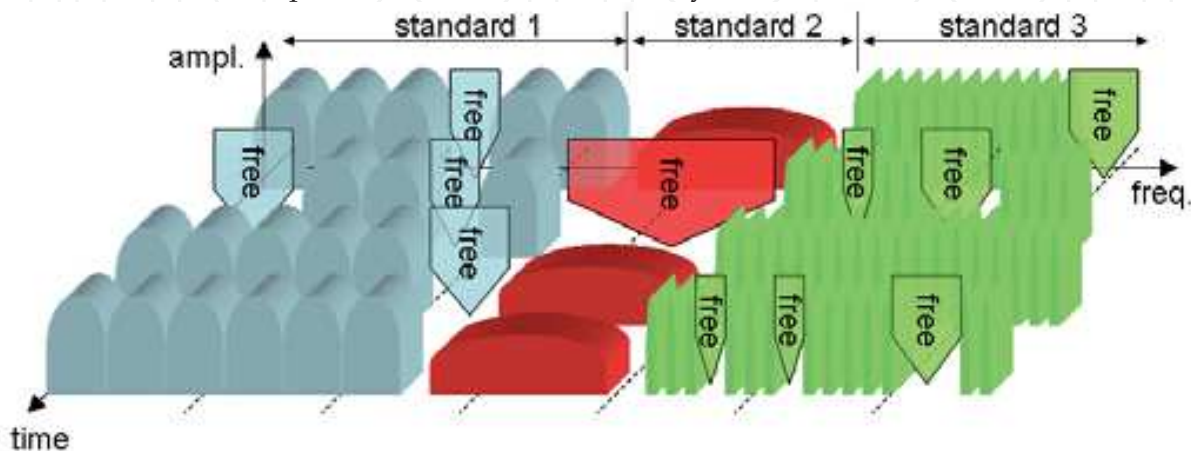

Fig. 14. Spectrum access in a multi-standard system scenario.

HPA efficiency curve is shown in Fig. 15 following the context of the discussion here. Generally it is preferred to operate PA in the maximum efficiency region near saturation point. But for that signal fluctuations should be kept as small as possible otherwise non-linearity would occur because of HPA operation in saturation region. Now spectrum access would definitely modify signal properties namely mean power, bandwidth, amplitude etc. As the signal fluctuations are modified on spectrum access, the operating point of HPA needs to be modified also so as to avoid non-linearity. Consider that the signal fluctuations increase on spectrum access which is generally the case after signal addition to useful band, one solution can be large IBO labeled as 'Solution 1: Large IBO' in Fig. 15. This large IBO results in the PA operation in less efficient zone which is obviously not recommended. Also, one needs to add some electronic components for real time operating point modifications according to signal fluctuations. This hardware implementation not only comes at the cost of more energy consumption but also it is difficult to realize on the transmitter circuitry.

The solution which we propose, labeled as 'Solution 2: Insertion with PAPR constraint' in Fig. 15, is to insert the added tones respecting the signal fluctuation constraints. If the added signal does not increase signal fluctuations, high efficiency PA operation is easily possible. Thus a frequency view of PAPR is highly essential to see the effect of the added signal on PAPR and to decide whether to insert the signal on some available band or not and if yes then what should be the characteristics of the added signal like amplitude or constellation size, bandwidth and position of the added carriers.

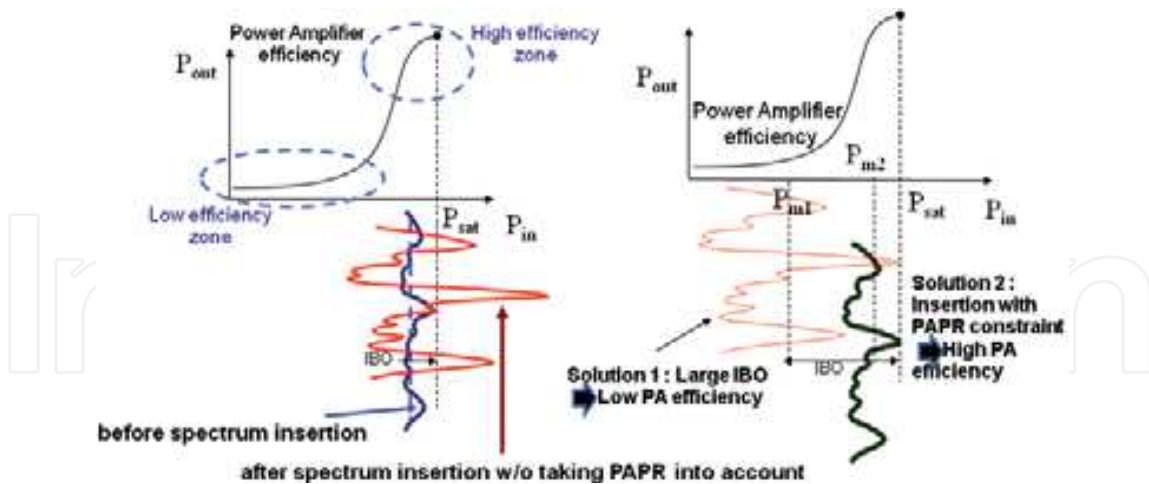

Fig. 15. Spectrum access effect on PAPR and in turns on PA efficiency.

7. Frequency view of PAPR metric

7.1 Frequency Domain Interpretation of PAPR Metric

Since PAPR is varied on spectrum access, its frequency domain interpretation would help in better understanding of these variations corresponding to the frequency components of signal (Hussain et al., 2008). To get the frequency vision of the signal, temporal SWR signal is first sliced into N_s symbols of N samples each. This process of slicing the temporal signal is illustrated in Fig. 16. These symbols fill the N_s rows of table 'S' in Fig. 17. Then, each row is processed with N point FFT to get the spectral components of the signal and thus table 'C' is filled in Fig.17.

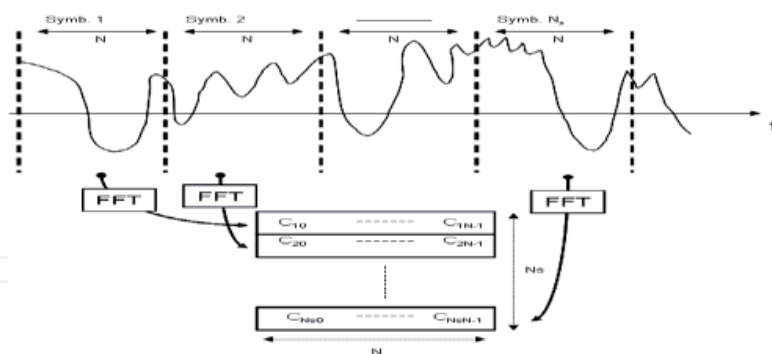

Fig. 16. Temporal signal slicing for PAPR upper bound calculation.

Note that, N should be large enough to contain all the frequency components in SWR signal. In Fig. 17, each row in table 'C' refers to frequency components $X_i(n)[i \in [J]]$ present in temporal SWR symbol $S_i(n)$ given by,

$$X_j(n) = \sum_{k=0}^{N-1} s_{j,k} e^{-2i\pi \frac{kn}{N}}, n \in [(j-1)N, jN-1], j \in [1, N_s]. \tag{14}$$

Here $J = [1, N_s]$ and each column is associated to a signal $\nu_k(n)$ given by,

$$v_k(j) = \sum_{m=0}^{N_S-1} C_{m,k} e^{2i\pi \frac{jm}{N_S}}, k \in K, j \in J. \tag{15}$$

Here $K = [0, N - 1]$. A column k is associated to a carrier f_k and the idea is to calculate PAPR column wise and to show that it is similar to PAPR calculated row wise.

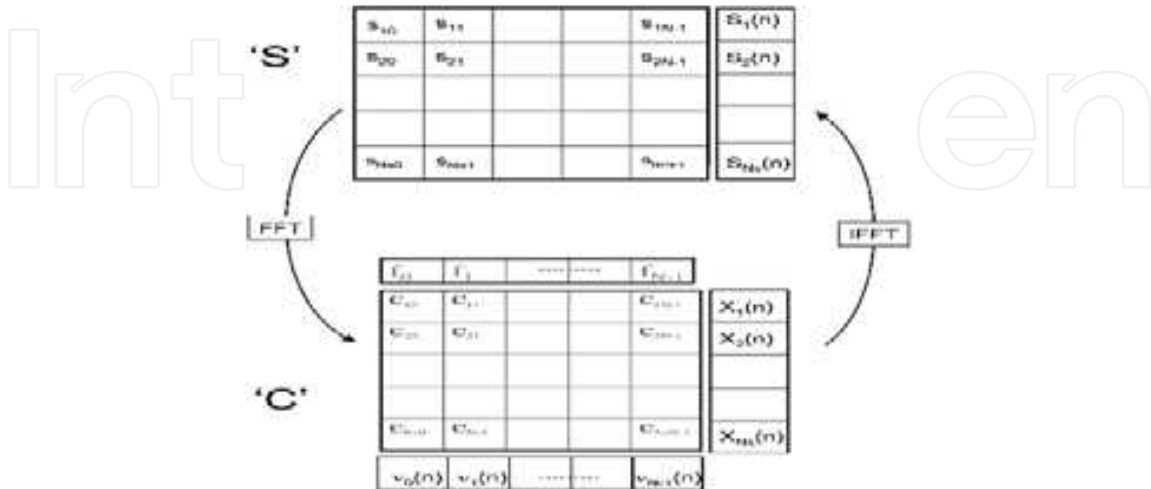

Fig. 17. Time and frequency vision of an SWR signal.

This new vision paves the way to a carrier wise analysis of PAPR whose objective is to find a relation between $PAPR_{N_S}$ (PAPR calculated over time domain table ‘S’) and power ratios $PAPR_{f_k}$ calculated on each carrier f_k given by,

$$PAPR_{f_k} = \frac{\max_{j \in J} |C_{j,k}|^2}{\frac{1}{N_S} \sum_{j=1}^{N_S} |C_{j,k}|^2} = \frac{\max_{j \in J} |C_{j,k}|^2}{P_m(k)}, \tag{16}$$

where $P_m(k)$ refers to mean power calculated on carrier f_k . By using temporal expression of the SWR symbols, it can be easily shown that,

$$PAPR_{N_S}(S(n)) = \frac{\max_{k \in K} (\max_{j \in J} (|s_{j,k}|^2))}{\frac{1}{N_S} \sum_{j=1}^{N_S} E[|s_{j,k}|^2]}. \tag{17}$$

Using Fourier transform relation,

$$|s_{j,k}|^2 = \sum_{p=1}^N |C_{j,p}|^2 + \lambda(j,k), j \in J, k \in K. \tag{18}$$

with

$$\lambda(j,k) = \sum_{p=1}^N C_{j,p} \sum_{p' \neq p} \overline{C_{j,p'}} e^{2i\pi \frac{k(p-p')}{N}}, j \in J, k \in K.$$

As

$$\max_{j \in J} |C_{j,k}|^2 = P_m(k) \times PAPR_{f_k}, \tag{19}$$

the final result would be,

$$PAPR_{N_s}(S(n)) \leq \frac{1}{\sum_{k=1}^N P_m(k)} \left[\left(\sum_{k=1}^N P_m(k) \times PAPR_{f_k} \right) + \max_{k \in K} \left(\max_{j \in J} (\lambda(j, k)) \right) \right]. \quad (20)$$

In this equation, $PAPR_{N_s}$ is upper bounded by addition of the weighted average of all $PAPR_{f_k}$ metrics and a constant depending on the frequency component correlation. From now onwards $PAPR_{N_s}$ will be termed as $PAPR_{temp}$ to underline temporal PAPR.

7.2 Application of Frequency PAPR definition to SWR signal

A composite SWR signal of multi carrier modulation schemes of two OFDM based standards was simulated. Standard A was composed of 64 OFDM carriers while Standard B was composed of 256 OFDM carriers. Standard A transmits with 25 dB less power than Standard B. This SWR signal was mapped to the mentioned table format where each row of the table ' S ' representing time domain SWR symbols. 10^3 SWR signals of length 4096 were simulated. The table was transformed to frequency domain using 1024 point FFT to fill ' C ' of size 4×1024 . Fig. 18 demonstrates the application of Eq. 20 to SWR signal.

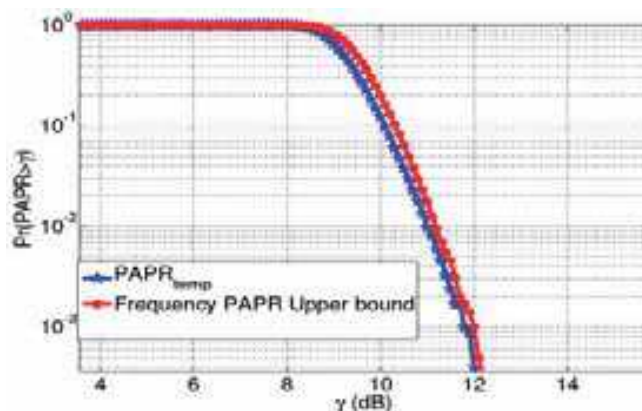

Fig. 18. Frequency PAPR calculation for SWR signal.

7.3 PAPR variations on dynamic spectrum access: mathematical developments

A study on the PAPR variation due to spectrum access is carried out and mathematically formulated. Let $PAPR_{new}$ be the PAPR after spectrum access. It can be upper bounded by the sum of initial PAPR of the primary users' signal before spectrum access $PAPR_p$ given by Eq. 20 and the influence of the secondary users' signal on PAPR, to be given after mathematical developments.

Consider the case of a CR signal, where different standards occupy their specific bandwidths while the free bandwidth is used by the secondary users. Transforming the temporal CR signal into the frequency domain following the carrier per carrier vision presented above. Let the signal be divided in to N_s symbols and N be frequencies of the whole spectrum. Out of these N frequencies, N_p are the primary user frequencies and N_s be the frequencies that are used by secondary users. Here the hypothesis is made that the spectrum occupied by secondary users is very small compared to primary users' spectral

occupancy i-e $N_s \ll N_p$ and also $P_m(p) + P_m(s) \approx P_m(p)$ due to the fact that the secondary signal mean power $P_m(s)$ is negligible compared to primary user mean power $P_m(p)$ due to spectral mask constraints.

A signal sample $s_{j,k}$ can be written as,

$$s_{j,k} = \sum_{c=0}^{N-1} C_{j,c} e^{i2\pi kc/N}, \quad (21)$$

where $j \in [1, N_S]$, $k \in [0, N-1]$. Also $c \in [0, N-1]$ is the number of carriers, i-e size of c is the sum of N_p and N_s . Now following the above equation

$$|s_{j,k}|^2 = \left| \sum_{c=0}^{N-1} C_{j,c} e^{i2\pi kc/N} \right|^2. \quad (22)$$

Dividing the carriers in to primary and secondary user carriers,

$$|s_{j,k}|^2 = \left| \sum_{p \in P} C_{j,p} e^{i2\pi kp/N} + \sum_{s \in S} C_{j,s} e^{i2\pi ks/N} \right|^2. \quad (23)$$

Here P and S are the index sets of primary and secondary user frequencies respectively. Now following the inequality which states that for complex vectors a and b ,

$$|a + b| \leq |a| + |b|,$$

and consequently

$$(|a + b|)^2 \leq (|a| + |b|)^2. \quad (24)$$

Thus Eq. 23 becomes,

$$|s_{j,k}|^2 \leq \left(\left| \sum_{p \in P} C_{j,p} e^{i2\pi kp/N} \right| + \left| \sum_{s \in S} C_{j,s} e^{i2\pi ks/N} \right| \right)^2, \quad (25)$$

and

$$\begin{aligned} |s_{j,k}|^2 &\leq \left| \sum_{p \in P} C_{j,p} e^{i2\pi kp/N} \right|^2 + \left| \sum_{s \in S} C_{j,s} e^{i2\pi ks/N} \right|^2 \\ &+ 2 \left| \sum_{p \in P} C_{j,p} e^{i2\pi kp/N} \right| \left| \sum_{s \in S} C_{j,s} e^{i2\pi ks/N} \right|. \end{aligned} \quad (26)$$

Let

$$\begin{aligned} \zeta_{j,k} &= \left| \sum_{p \in P} C_{j,p} e^{i2\pi kp/N} \right|^2 + \left| \sum_{s \in S} C_{j,s} e^{i2\pi ks/N} \right|^2 \\ &+ 2 \left| \sum_{p \in P} C_{j,p} e^{i2\pi kp/N} \right| \left| \sum_{s \in S} C_{j,s} e^{i2\pi ks/N} \right|. \end{aligned} \quad (27)$$

Now following Eq. 20,

$$PAPR_{N_s}(S(n)) \leq \frac{\max_{k \in K} (\max_{j \in J} (\zeta_{j,k}))}{\sum_{k=1}^N P_m(k)}. \quad (28)$$

And thus the above equation can be written as,

$$PAPR_{N_s}(S(n)) \leq PAPR_p + \delta. \quad (29)$$

Here $PAPR_p$ is the PAPR contribution because of primary user's carriers i-e,

$$PAPR_p \approx \frac{\max_{k \in K} (\max_{j \in J} (|\sum_{p \in P} C_{j,p} e^{i2\pi kp/N}|^2))}{\sum_{k=1}^N P_m(k)}. \quad (30)$$

And δ is the amount of variation in the initial PAPR, $PAPR_p$, because of dynamic spectrum access. The factor δ can be written as,

$$\delta = \delta_s + \delta_m, \quad (31)$$

where,

$$\delta_s \approx \frac{\max_{k \in K} (\max_{j \in J} (|\sum_{s \in S} C_{j,s} e^{i2\pi ks/N}|^2))}{\sum_{k=1}^N P_m(k)} = \frac{\sum_{s \in S} P_m(s)}{\sum_{p \in P} P_m(p)} \cdot PAPR_s. \quad (32)$$

In Eq. 32, the factor $\frac{\sum_{s \in S} P_m(s)}{\sum_{p \in P} P_m(p)}$ is the ratio of secondary user's mean power to the primary user's mean power which is quite small and that's why the factor δ_s does not contribute much to the PAPR variations. Also $PAPR_s$ is the secondary user PAPR in frequency domain, i-e,

$$PAPR_s = \frac{\max_{k \in K} (\max_{j \in J} (|\sum_{s \in S} C_{j,s} e^{i2\pi ks/N}|^2))}{\sum_{s \in S} P_m(s)}. \quad (33)$$

And

$$\delta_m \approx \frac{1}{\sum_{k=1}^N P_m(k)} [\max_{k \in K} (\max_{j \in J} (2|\sum_{p \in P} C_{j,p} e^{i2\pi kp/N}| \cdot |\sum_{s \in S} C_{j,s} e^{i2\pi ks/N}|))]. \quad (34)$$

Here δ_m is the contribution because of the mutual correlation of the primary and secondary user carriers. It should be noted that the influence on PAPR due to spectrum access can be calculated with the help of spectral information of the primary and secondary signal. This vision facilitates the spectrum access phenomenon in the context of CR by directly relating the effect on PAPR with the spectral information of signal.

This formulation is applied on aforementioned bi-standard SWR signal. QPSK modulated ¹⁰ carriers are added on free bands in between these two standards and their effect on PAPR is demonstrated in Fig. 19.

7.4 Frequency PAPR view benefit

Let us now explain the advantages of using frequency view for PAPR computation over a temporal PAPR calculation approach in a CR spectrum access scenario. As mentioned previously that spectrum access influences the transmitted signal properties and subsequently its PAPR. PAPR of the signal to be amplified i-e signal between f_{min} and f_{max} in Fig. 20 is increased after spectrum access where W is the available free bandwidth and B is the allocated bandwidth for secondary user during spectrum access. This increase in PAPR can cause signal distortion. Therefore, in order to see the effects on PAPR due to the allocated bandwidth, a classical temporal vision would need constant exchanges between frequency domain (for bandwidth allocation) and time domain (for PAPR computation) in order to select a bandwidth which does not increase a lot the PAPR of the signal to be amplified after spectrum access. This implies a tremendous increase in computational

complexity. In the PAPR frequency view, the effects on PAPR due to any available band allocation can be seen in the frequency domain without going back to time domain for PAPR calculations. Moreover, this spectrum knowledge can be used by other CR sensors like (Hachemani et al., 2007) uses power spectral density of the signal for blind standard recognition. Fig. 20 explains that this approach facilitates bandwidth allocation with respect to PAPR metric in CR context. A two standard SWR signal is depicted with an available bandwidth W . After slicing of the temporal signal and FFT operation, a table is filled with signal's spectral components. Then a suitable bandwidth B is allocated by the CR system while $PAPR_{temp}$ computations are performed staying in the frequency domain during bandwidth selection procedure.

This frequency vision also helps in PAPR mitigation e-g PAPR reduction by 'Tone Reservation' (Tellado-Mourelo, 1999) is about reserving tones in frequency domain to reduce PAPR for OFDM signals. This process is same as bandwidth allocation. Knowing the fact that OFDM and SWR signals show similar characteristics (Hussain & Louët, 2008) and carrier per carrier vision facilitates bandwidth allocation, OFDM PAPR mitigation methods can easily be applied to SWR signals.

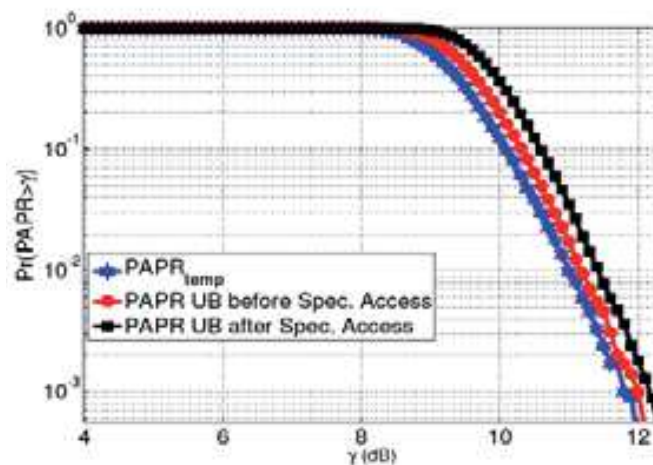

Fig. 19. Upper bound is modified after spectrum access

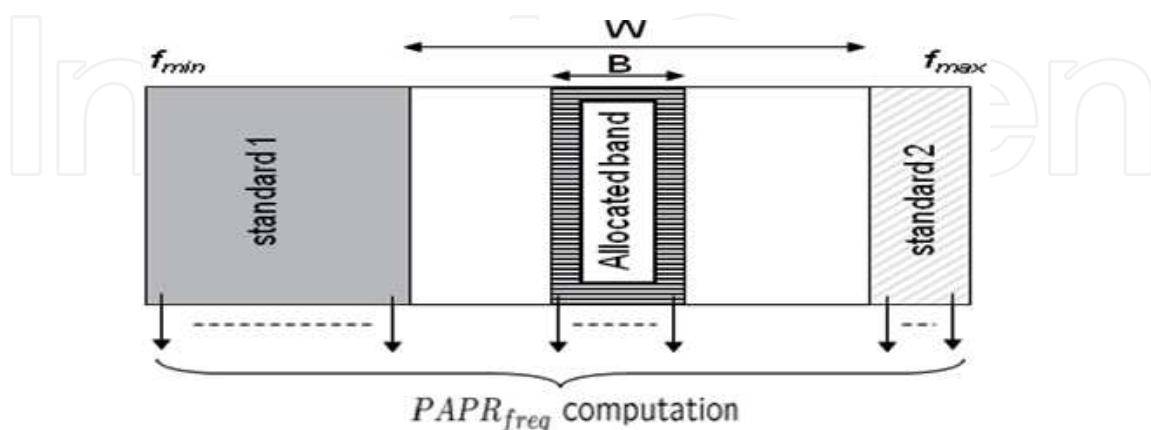

Fig. 20. Illustration of PAPR computation with a two standards SWR signal and an allocated bandwidth B .

8. Conclusion

This chapter explores the non linearity issues in SWR based CR systems in the spectrum access scenario by exploiting the frequency vision of PAPR. The importance of this issue can be estimated by a simple fact that reduced PAPR would result in higher PA efficiency and in turns reduced energy consumption which is closely related to 'Green communication' concept (ICC, 2009). Also the problem is addressed at the receiver end on Low Noise Amplifier (LNA) (Marshall, 2009). High PAPR being a major problem in multi carrier communications and CR signal being a multi carrier signal suffers the same problem. Spectrum access in the CR context is about using the free spectrum under certain constraints like QoS maintenance of the primary users. Another constraint for spectrum access is discussed in this chapter which is PAPR as high PAPR affects transmitter specifications. A carrier per carrier vision approach is presented which associates PAPR with spectrum. This spectral knowledge based PAPR definition helps in spectrum access by providing PAPR information about available bandwidths. An upper bound is given for PAPR after spectrum access which is based on the spectral knowledge of primary and secondary users. The process of spectrum access under PAPR metric constraint is facilitated with this frequency PAPR vision.

9. References

- Bremenson, C. et al. (1980), Linearizing TWT Amplifiers in Satellite Transponders, Systems Aspects and Practical Implementation, *Proc. AIAA 8th Communications Satellite System Conference*, April 1980, pp. 80-89.
- Fasbender, A.; Reichert, F.; Geulen, E.; Hjelm, J. & Wierlemann, T. (1999). Any Network, Any Terminal, Anywhere, *IEEE Personal Communication*, Vol. 6, No. 2, April 1999, pp. 22-30.
- FCC. (2003). <http://www.fcc.gov/oet/cognitiveradio/>
- Hachemani, R., Palicot, J. & Moy, C. (2007). A New Standard Recognition Sensor for Cognitive Radio Terminals, *EUSIPCO*, September 2007.
- Han, S.H., Lee, J.H. (2005) An overview of Peak to Average Power Ratio Reduction techniques for Multicarrier Transmission, *IEEE Wireless Communications*, April 2005, pp. 56-65.
- Hussain, S., Palicot, J., Louët, Y., Zabré, S. (2008). *Frequency Domain Interpretation of Power Ratio Metric for Cognitive Radio Systems*, Proceedings of IET Communications Journal, Vol. 2, Issue 6, July 2008, pp.783-793.
- Hussain, S. & Louët, Y. (2008). Peak to Average Power Ratio Analysis of Multi-carrier and Multi-standard signals in software radio context, *IEEE ICTTA 08*, Damas, April 08.
- ICC. (2009). <http://www.ieee-icc.org/workshops.html#GreenComm>
- Kenington, P. B. (2000). *High-linearity RF amplifier design*, Artech House Inc. Boston-London. ISBN: 1580531431.
- Lee, H., Liu, D.N., Zhu, W., Fitz, M.P. (2005). Peak power reduction using a unitary rotation in multiple transmit antennas, *IEEE International Conference on Communication*, Vol. 4, May 2005, pp. 2407-2411.

- Louët, Y. & Palicot, J. (2008). A classification of methods for efficient power amplification of signals, *Annals of Telecommunications*, Vol. 63, Issue 7-8, July/August 2008, pp. 351-368.
- Macleod, J., Beach, M., and al. (2000). IST-TRUST, 1999-12070, D3.1.1, *European Project*, Septembre 2000.
- Marshall, P. F. (2009). Cognitive Radio as a mechanism to manage front end linearity and dynamic range, *IEEE Communications Magazine*, March 2009, pp. 81-87.
- Mitola, J. & Maguire, G. Q. Jr. (1999). Cognitive Radio: Making Software Radios More Personal, *IEEE PCS Magazine*, Vol. 6, No. 4, August 1999, pp. 13-18.
- Ochiai, H. & Imai, H. (2001). On the distribution of the Peak to Average Power Ratio in OFDM Signals, *IEEE transactions on communications*, Vol. 49, No. 2, February 2001, pp. 282-289.
- Ragusa, S., Palicot, J., Roland, C., Lereau, C. (2005). Adjacent channel power ratio analysis for an OFDM signal, *IEEE ISSPIT 2005*, pp. 495-500.
- Roland, C. & Palicot, J. (2002). A Self Adaptive Universal Receiver, *Annals of Telecom*, 57, No. 5-6, May- June 2002.
- Soury, A., Ngoya, E. (2005). Modeling long term memory effects in microwave power amplifiers for system level simulations, *Annals of Telecom*, Vol. 60, No. 11-12, 2005, pp. 1488-1506.
- Steck, J. & Pham, D. (1987). A New TWT Linearizer for Satellite-Communications Transmitters, *Microwave System News and Communications Technology*, Vol. 17, No. 9, June 1987, pp. 28-42.
- Tan, M., Latinovic, Z., and Bar-Ness, Y. (2005). STBC MIMO-OFDM Peak-to-Average Power Ratio Reduction by Cross-Antenna Rotation and Inversion, *IEEE Communication Letters*, Vol. 9, No. 7, July 2005.
- Tellado-Mourelo, J. (1999). *Peak to Average Power Ratio Reduction for multicarrier modulation*, Ph.D thesis, Stanford University, September 1999.
- Zhao, Q., Swami, A. (2007). A survey of Dynamic spectrum access Signal Processing and networking perspectives, *ICASSP*, Vol. 4 April 2007, pp 1349-1352.

IntechOpen



Cognitive Radio Systems

Edited by Wei Wang

ISBN 978-953-307-021-6

Hard cover, 340 pages

Publisher InTech

Published online 01, November, 2009

Published in print edition November, 2009

Cognitive radio is a hot research area for future wireless communications in the recent years. In order to increase the spectrum utilization, cognitive radio makes it possible for unlicensed users to access the spectrum unoccupied by licensed users. Cognitive radio let the equipments more intelligent to communicate with each other in a spectrum-aware manner and provide a new approach for the co-existence of multiple wireless systems. The goal of this book is to provide highlights of the current research topics in the field of cognitive radio systems. The book consists of 17 chapters, addressing various problems in cognitive radio systems.

How to reference

In order to correctly reference this scholarly work, feel free to copy and paste the following:

J. Palicot, Y. Louet and S. Hussain (2009). Power Amplification Issues Related to Dynamic Spectrum Access in the Cognitive Radio Systems, Cognitive Radio Systems, Wei Wang (Ed.), ISBN: 978-953-307-021-6, InTech, Available from: <http://www.intechopen.com/books/cognitive-radio-systems/power-amplification-issues-related-to-dynamic-spectrum-access-in-the-cognitive-radio-systems>

INTECH
open science | open minds

InTech Europe

University Campus STeP Ri
Slavka Krautzeka 83/A
51000 Rijeka, Croatia
Phone: +385 (51) 770 447
Fax: +385 (51) 686 166
www.intechopen.com

InTech China

Unit 405, Office Block, Hotel Equatorial Shanghai
No.65, Yan An Road (West), Shanghai, 200040, China
中国上海市延安西路65号上海国际贵都大饭店办公楼405单元
Phone: +86-21-62489820
Fax: +86-21-62489821

© 2009 The Author(s). Licensee IntechOpen. This chapter is distributed under the terms of the [Creative Commons Attribution-NonCommercial-ShareAlike-3.0 License](https://creativecommons.org/licenses/by-nc-sa/3.0/), which permits use, distribution and reproduction for non-commercial purposes, provided the original is properly cited and derivative works building on this content are distributed under the same license.

IntechOpen

IntechOpen