

We are IntechOpen, the world's leading publisher of Open Access books Built by scientists, for scientists

5,300

Open access books available

130,000

International authors and editors

155M

Downloads

Our authors are among the

154

Countries delivered to

TOP 1%

most cited scientists

12.2%

Contributors from top 500 universities



WEB OF SCIENCE™

Selection of our books indexed in the Book Citation Index
in Web of Science™ Core Collection (BKCI)

Interested in publishing with us?
Contact book.department@intechopen.com

Numbers displayed above are based on latest data collected.
For more information visit www.intechopen.com



Applications of RFID Systems - Localization and Speed Measurement

Valentin Popa, Eugen Coca and Mihai Dimian
*Faculty of Electrical Engineering and Computer Science
Stefan cel Mare University of Suceava,
Romania*

1. Introduction

Many efforts were made in the last years in order to develop new techniques for mobile objects identification, location and tracking. Radio Frequency Identification (RFID) systems are a possible solution to this problem. There are many different practical implementations of such systems, based on the use of radio waves from low frequencies to high frequencies. In this chapter we present a short review of existing RFID systems and an in depth analysis of one commercial development system. We also present a speed measurement application using the same RFID system. The last section of this chapter offers important electromagnetic compatibility (EMC) information regarding the use of high frequency RFID systems. All results are from experiments performed in real life conditions. EMC and speed measurements were performed in a 3 m semi-anechoic chamber using state-of-the-art equipments.

2. RFID locating systems

Localization of mobile objects has become of great interest during the last years and it is expected to further grow in the near future. There are many applications where precise positioning information is desired: goods and assets management, supply chain management, points of interest (POIs), proximity services, navigation and routing inside buildings, emergency services as defined by the E911 recommendations (FCC 1996) in North America and EU countries, etc. There are numerous outdoor solutions, based mainly on Global Positioning Systems (GPS) but there are also so-called inertial systems (INS). Solutions based on cellular phone networks signals are another good example of outdoor positioning service. For GPS based solution the precision of location is dictated by a sum of factors, almost all of them out of user control. Inertial systems can provide continuous position, velocity and orientation data that are accurate for short time intervals but are affected by drift due to sensors noise (Evennou & Marx, 2006). For indoor environments the outdoor solutions are, in most of the practical situations, not applicable. The main reason is that the received signal, affected by multiple reflection paths, absorptions and diffusion (Wolfe et al., 1999), is too weak to provide accurate location information. This introduces difficulties to use positioning techniques applied in cellular networks (time of arrival, angle of arrival, observed time reference, etc.) in order to provide accurate location information inside buildings or isolated areas. Indoor positioning systems should provide the accuracy desired by the context-aware applications that will be installed in that area.

Source: Radio Frequency Identification Fundamentals and Applications, Bringing Research to Practice, Book edited by: Cristina Turcu, ISBN 978-953-7619-73-2, pp. 278, February 2010, INTECH, Croatia, downloaded from SCIYO.COM

There are three main techniques used to provide location information: triangulation, scene analysis and proximity (Finkenzeller 2003). These three techniques may be used separately or jointly. Indoor positioning systems may be divided into three main categories. First of all there are systems using specialized infrastructure, different from other wireless data communication networks. Second, there are systems based on wireless communication networks, using the same infrastructure and signals in order to obtain the location information. Third, there are mixed systems that use both wireless networks signals and other sources to achieve the goal. There are many implementations, we mention here several of them having something new in technology and/or the implementation comparing with previous systems (Gillieron et al., 2004; Gillieron & Merminod, 2003; Fontana 2008; D'Hoe et al., 2009; Priyantha et al. 2000; Van Diggelen & Abraham, 2001; De Luca et al., 2006; Ni et al., 2003; Bahl et al., 2000):

- Active Badge is a proximity system that uses infrared emission of small badges mounted on the moving objects. A central server receives the signals and provides location information as the positions of the receivers are known;
- Cricket system from MIT which is based on "beacons" transmitting an RF signal and an ultrasound wave to a receiver attached to the moving object. The receiver estimates its position by listening to the emissions of the beacons based on the difference of arrival time between the RF signal and the ultrasound wave;
- MotionStar is a magnetic tracker system which uses electromagnetic sensors to provide position information;
- MSR Easy Living uses computer vision techniques to recognize and locate objects in 3D;
- MSR Radar uses both triangulation based on the attenuation of the RF signal received and scene analysis;
- Pinpoint 3D-iD which uses the time-of-flight techniques for RF emitted and received signals to provide position information;
- Pseudolites are devices emulating the GPS satellite signals for indoor positioning;
- RFID Radar which used RF signals;
- SmartFloor utilizes pressure sensors integrated in the floor. The difference of pressure created by a person movement in the room is analyzed and transmitted to a server which provides the position of that person;
- SpotON is a location technology based on RF signals. The idea is to measure on the fixed receivers the strength of the RF signals emitted by the tags mounted on moving objects to be located.

3. Location applications using a RFID system

3.1 Introduction

RFID systems are still developing, despite the problems and discussions generated by privacy issues. Many commercially available systems using passive or active transponders provide only information regarding the identity (ID), memory content and in very few cases, the position of the transponders relative to a fixed point, usually the main antenna system. Very few progresses were made in the direction of using these systems for real-time position or speed measurements. One development system delivering accurate positioning information for active transponders is the RFID Radar from Trolley Scan.

3.2 RFID radar locating system description

The locating system we used to perform the location measurement tests is a mixed one, based on both ToA - Time of Arrival and AoA - Angle of Arrival methods (Coca & Popa, 2007). It uses a system based on one emitting antenna and two receiving ones. The working principle, mainly based on a tag-talks-first protocol (Coca et al., 2008), is as follows: when a transponder enters the area covered by the emitting antenna, it will send its ID and memory content. The signal transmitted by the transponder is received by two receiving antennas. Based on the time difference between the two received signals and the range data, it computes the angle and the distance information.

We used for our tests active long-range transponders of Claymore type. The system uses a central frequency of 870.00 MHz with a bandwidth of 10 kHz.

3.3 Experimental setup and measurement results

Experimental setup included an anechoic chamber, the RFID system with the antenna system and several transponders as shown in the figure bellow:

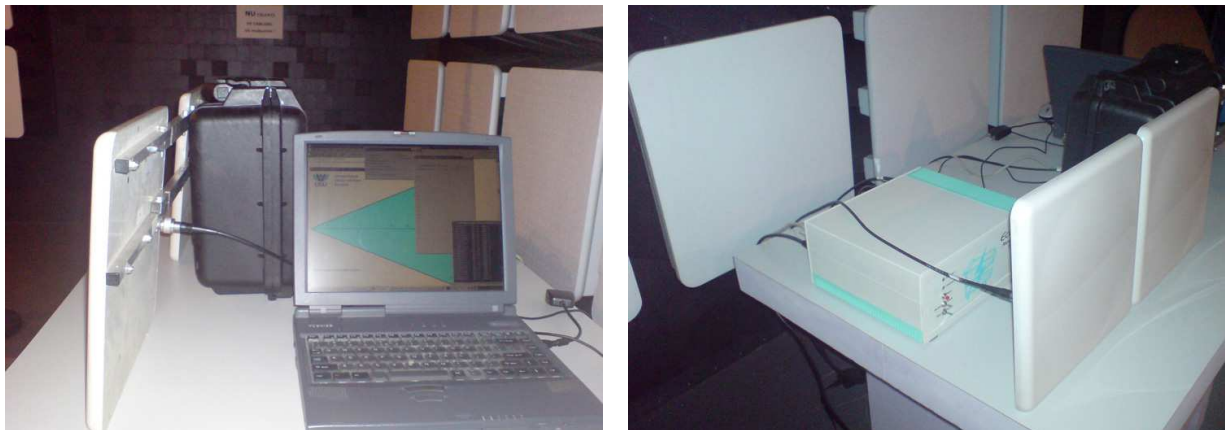

Fig. 1. The RFID system on the turn-table in the anechoic chamber with the control computer connected to the Ethernet network via optical-fibre isolated converters

The diagrams shown bellow are obtained from the signal transmitted between the receiving antennas pre-processor (and the demodulation block) and the digital processing board located inside the reader. The board is made using a Microchip Explorer 16 development board. We used for measurements a LeCroy 104Xi scope and 1/10 passive probes.

A typical signal received by the processing board, when only one active transponder is in the active area of the reader, is represented in Figure 2. When multiple transponders are located in the Radar range, the received signal contains multiple data streams. See, for example, Figure 3, which presents the signal received in the presence of four transponders. The information transmitted by the reader system to the processing board inside the reader is plotted in Figure 4.

The transmission duration for one transponder takes approximately 2.66 milliseconds for 1024 bits. The ID bits from the first part of the transmission, the so-called header, which is shown in the zoomed part at the bottom of Figure 5. The last part of the transmission contains the information regarding the angle and time relative to the receiving antennas.

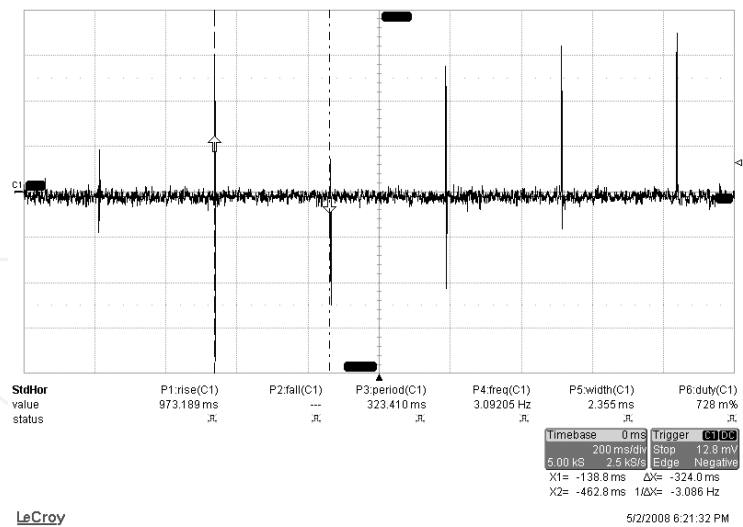

Fig. 2. Reading one transponder every 333 ms

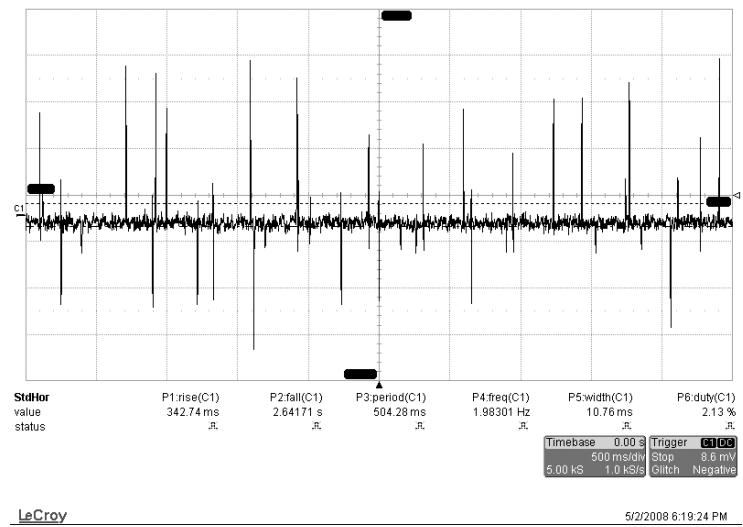

Fig. 3. Four transponders located in reader's range

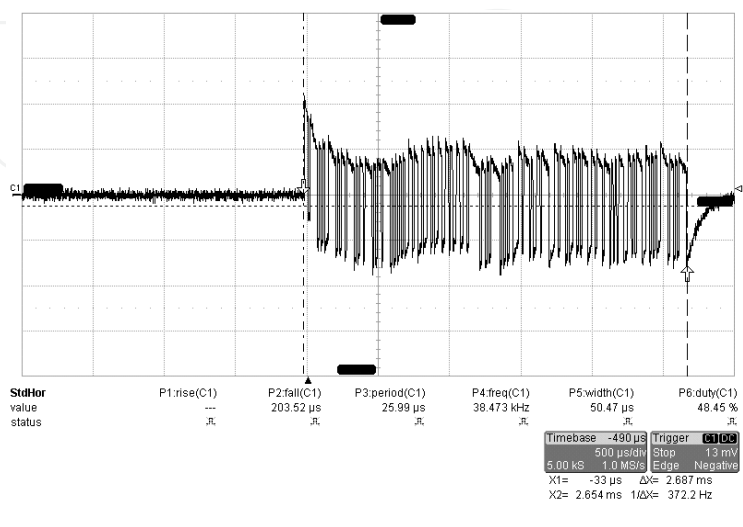

Fig. 4. Reading 1024 bits from one transponder takes 2.66 ms

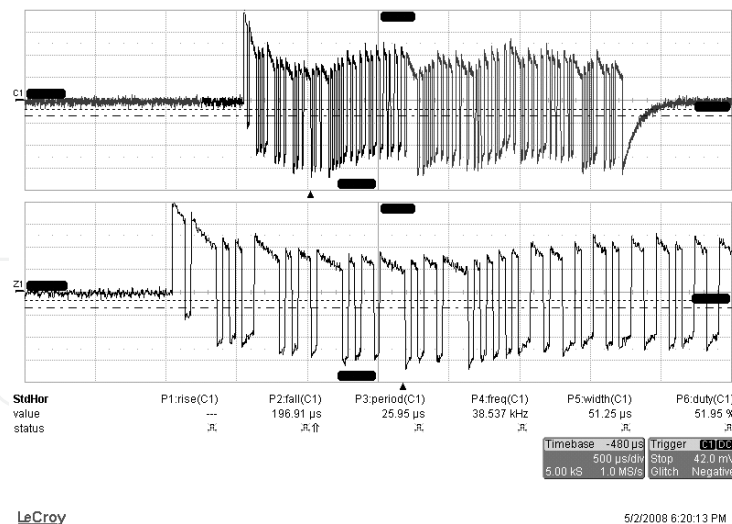

Fig. 5. Header data with one active transponder

As one can see in Figure 6, a bit is transmitted every 26 microseconds.

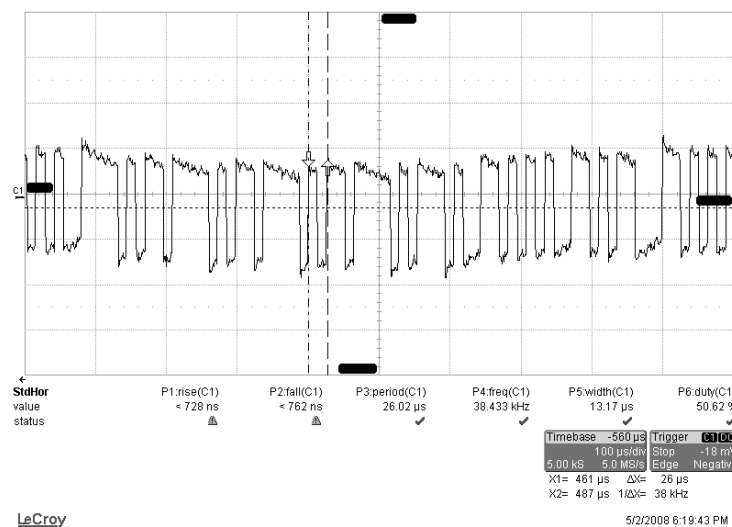

Fig. 6. Every bit takes about 26 µs to be transmitted

We made a series of tests during several days, in different environmental conditions and using various positions for the tags. Before starting the measurement session the receiver itself must be calibrated using, as recommended by the producer, an active tag. The tag was positioned in the centre in front of the antenna system at 9 m distance. The operation is mandatory as the cables length introduces delays in the signal path from the antenna to the receiver. We made a calibration for every site we made the measurements, in order to compensate the influence of antenna, cables and receiver positions.

For the tests we used all three types of tags provided (two active and one passive). The batteries voltages were checked to be at the nominal value before and after every individual test in order to be sure the results were not affected by the low supply voltage. For the first set of tests we used a real laboratory room (outdoor conditions), with a surface of about 165 square meters (7.5 meters x 22 meters). There were several wooden tables and chairs inside, but we did not changed their positions during the experiment. The antenna system was mounted about 1.4 meters height above the ground on a polystyrene stand, with no objects

in front. All tags were placed at the same height, but their positions were changed in front of the antenna. We used a notebook PC to run the control and command software.

We present only the relevant results of the tests and conclusions, very useful for future developments of this kind of localization systems. For the first result presented we used two long range tags, one Claymore (at 10 meters in front of the antenna) and one Stick type (at 5 meters) - Figure 7.

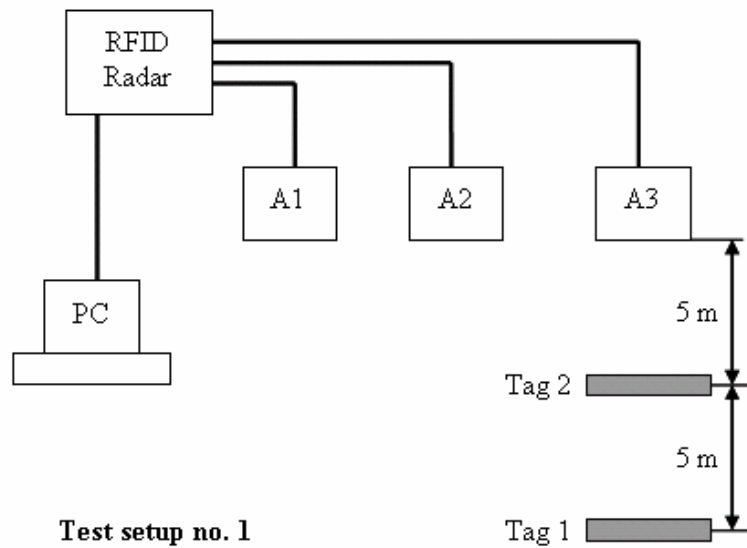

Fig. 7. Test setup for distance measurement from two tags - one at 5 m and the second at 10 m in front of the antenna

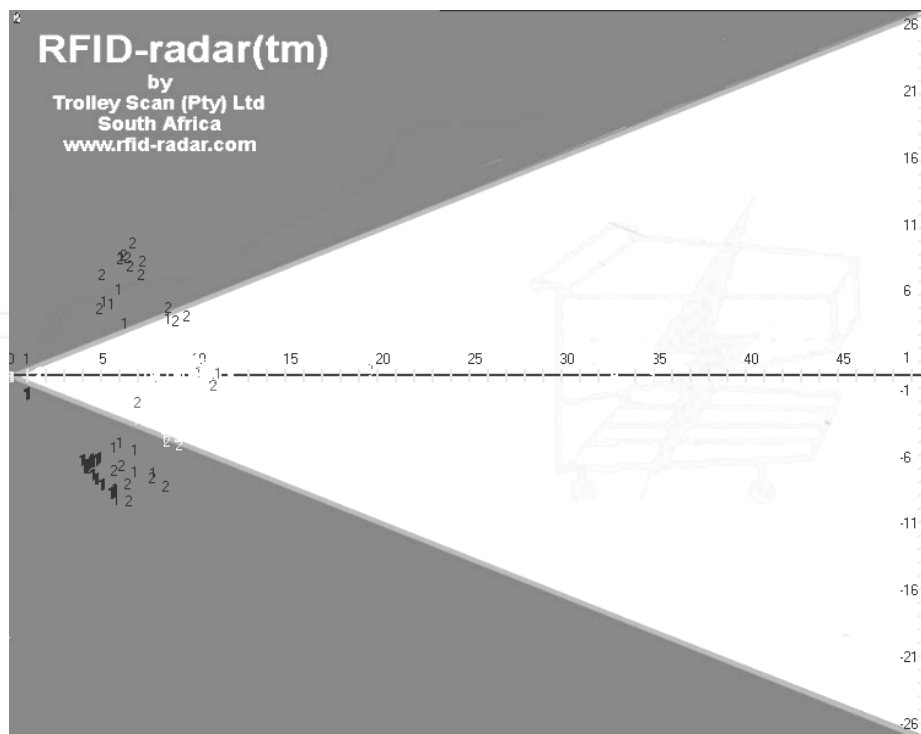

Fig. 8. Results for 2 active tags placed on 5 meters and 10 meters respectively, in front of the antenna system in a room

As one might see in Figure 8, the positions for each individual tag reported by the system were not stable enough in time. We run this measurement for several times using the same spatial configuration for all elements. The test presented here was made for duration of 4 hours. Analyzing the numerical results, we find out that 65% of cases where for the tag located at 5 meters the position was reported with an error less than 10% and for 47% of cases the results were affected by the same error for the tag located 10 meters in front of the antenna.

The second setup was the same in respect of location of the measurement, but one tag was moved more in front of the antenna system, at a distance of 20 meters. The results are practically the same regarding the position dispersion. Only in about 35% of all measurements for the tag situated at 20 meters the results were with an error less than 10%.

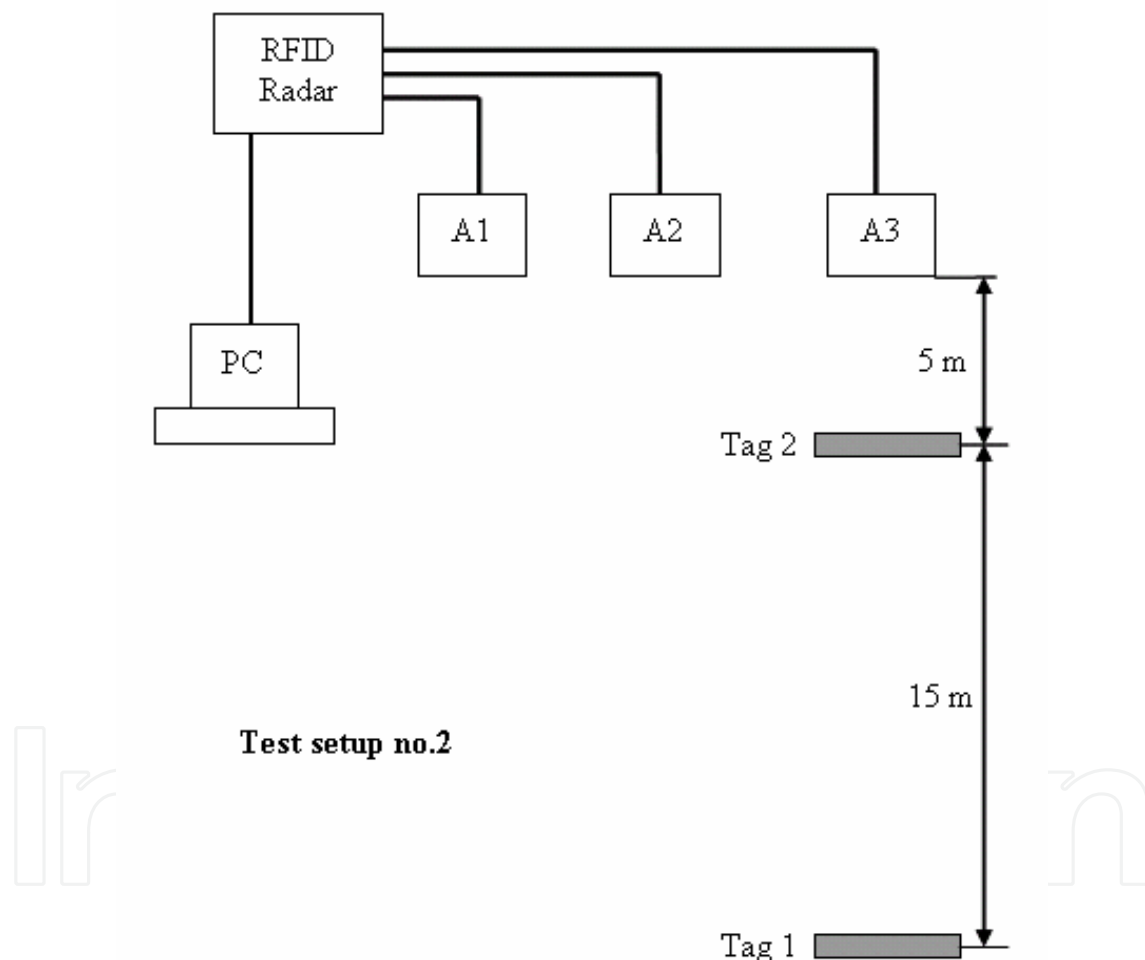

Fig. 9. Test setup for distance measurement for two tags - one at 5 m and the second at 20 m in front of the antenna

The measurements for the third case presented here were made in an open area, with no obstacles between the antenna system and the tags, using a tag placed at 10 meters in front of the antenna. The results obtained (Figure 10) are much better than the results from the measurements done in the laboratory. In this case (Figure 11) about 6 % of the measured distances were affected by an error more than 10 %.

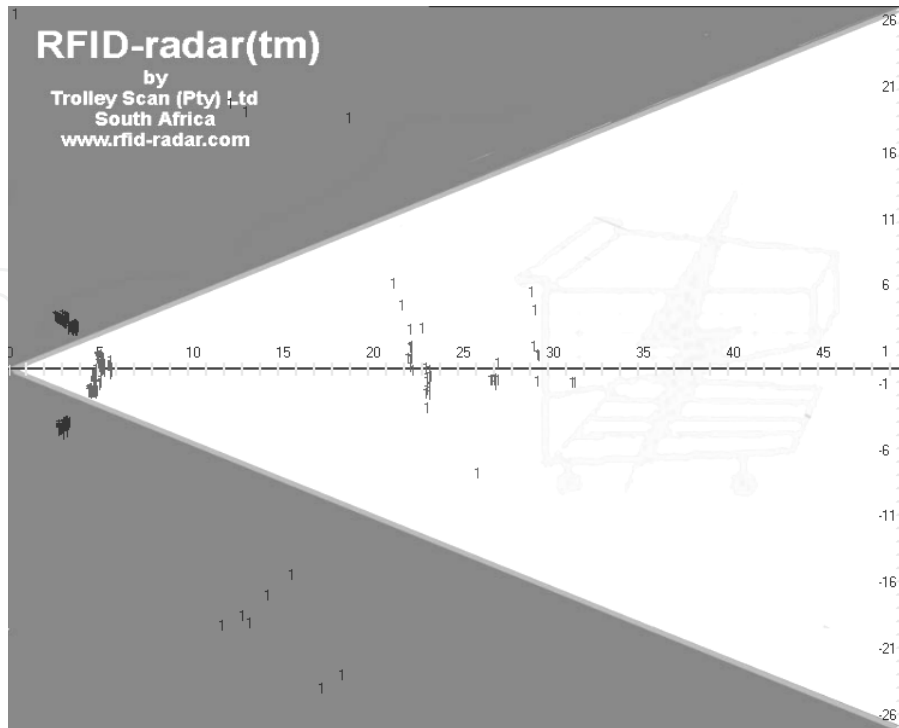

Fig. 10. Results for 2 active tags placed on 5 m and 20 m respectively, in front of the antenna system in a room

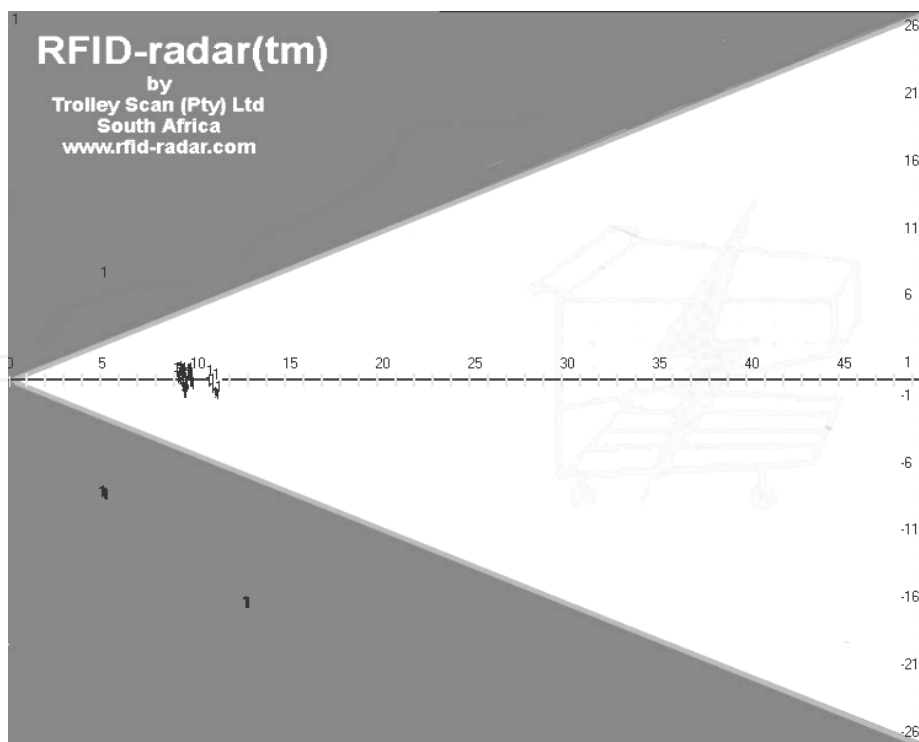

Fig. 11. Results for 1 active tag placed on 10 meters in front of the antenna system in an open-area site

4. Speed measurement applications using a RFID system

4.1 Calculating the speed using distance and angle information

In order to calculate the speed of the moving transponder we need to know the distances and the angles for two consecutive points P1 and P2. Our system provides distance and angle information for transponders in range. We assume the movement between these points is linear, which is a reasonable assumption for small distances.

The equipment computes the distance between the reference point "0" (located in the middle of the antenna system) and the transponder, as well as the angle between the reference axis and the line connecting "0" to the transponder. Let us consider that the moving object is located at points P1 and, respectively, P2, at two consecutive readings. Since the RFID radar provides the values of d_1 , d_2 , α_1 and α_2 , one can determine the distance between the two points as it follows.

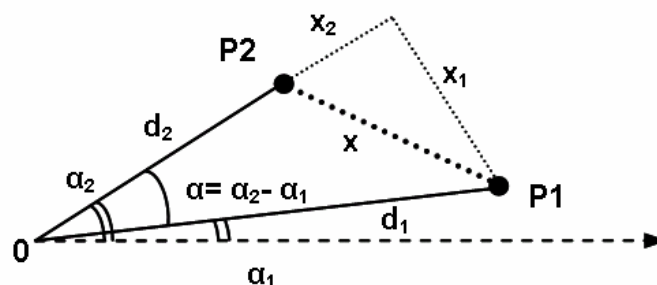

Fig. 12. Calculating the speed from two distances and two angles of two consecutive positions

By taking into account the diagram presented in Figure 12, one can derive the following expressions:

$$x = \sqrt{d_1^2 + d_2^2 - 2 \cdot d_1 \cdot d_2 \cdot \cos \alpha} \quad (1)$$

For the variables in these equations, we have the values determined at two time moments t_1 and t_2 , so computing the speed of the object having attached the tag is obvious:

$$v = \frac{x}{\Delta t} = \frac{\sqrt{d_1^2 + d_2^2 - 2 \cdot d_1 \cdot d_2 \cdot \cos \alpha}}{t_2 - t_1} \quad (2)$$

4.2 Software diagram of the speed computing program

We have developed a software program to compute the speed based on the location information provided by the RFID reader and have made various performance tests using a RFID Radar. The program was developed on a platform running Windows XP as an operating system. We used Power Basic for writing and compiling the program, with very good results regarding the processing speed. Data was exchanged with the RFID system by using the RS232C serial interface. Results were delivered in a text box and were written in a text file on the local disk.

Figure 13 presents the software diagram for calculating the speed. The process begins with a system initialization procedure, followed by a calibration routine. After these operations, we

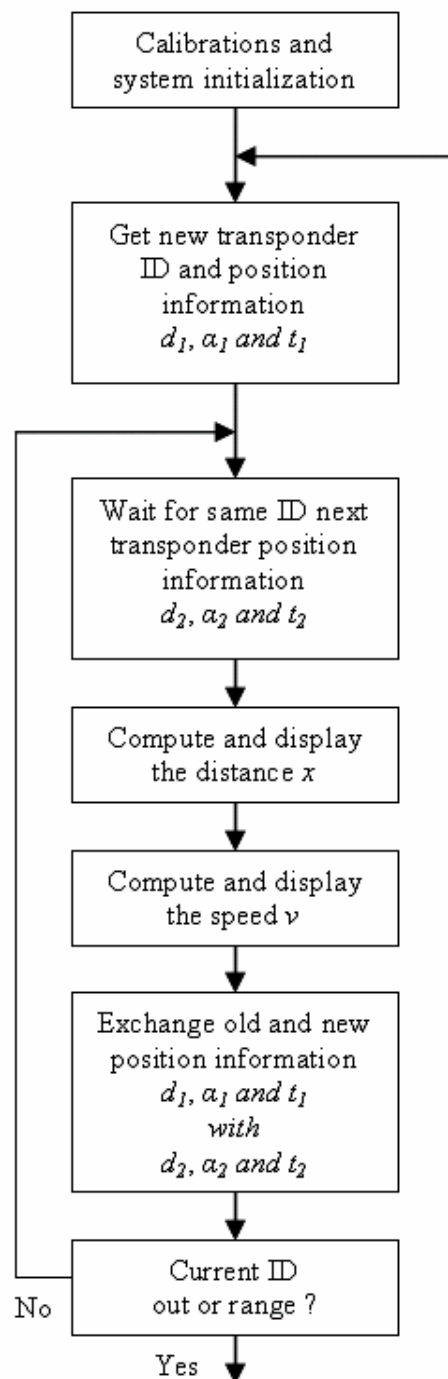

Fig. 13. Software diagram to calculate the transponder speed

wait for a transponder to come in the active range of the antennas. When the transponder enters the range, we get the current information, such as the unique ID, the location and time information. We do not need, and consequently, do not process any information stored in the transponder internal memory. After a delay of about 100 ms, the program enters a routine expecting the next reading. When receiving the same ID, the program gets the new values for location and time information, and then, it computes and displays the distance travelled by the transponder, and its speed.

When the current transponder ID is out of range, the program will acquire a new unique ID to calculate the new speed. If another transponder comes into the active range of the reader while the software is acquiring the speed for one transponder, the last one will not be read. In Figure 14 one may see the distance calibration process necessary to be made at system initialization, before any speed measurement could be done.

```

BCBBB4581^ 08.84 -001.1
BCBBB4581^ 08.84 -001.2
BCBBB4581^ 08.90 -001.2
BCBBB4581^ 08.84 -001.3
CALIBRATE
BCBBB4581^ 08.84 -001.3
BCBBB4581^ 08.84 -001.2
BCBBB4581^ 08.84 -001.3
BCBBB4581^ 08.79 -001.3
BCBBB4581^ 08.79 -000.1
BCBBB4581^ 08.79 000.2
BCBBB4581^ 08.83 000.4
BCBBB4581^ 08.83 000.2
BCBBB4581^ 08.83 -000.2
BCBBB4581^ 08.82 -000.8
BCBBB4581^ 08.76 -000.9
BCBBB4581^ 08.82 000.0
BCBBB4581^ 08.84 000.8
BCBBB4581^ 08.84 000.0
BCBBB4581^ 08.84 -001.1
B-08EA 090B 093B 098A 09C1 -01AE 0202 023A 025B 0267
A-0795 078A 0795 07C8 0883 -0005 001F 0054 00DB 013D
Calibration successful
BCBBB4581^ 09.34 -001.1

```

Fig. 14. RFID system calibration using a transponder at 9 m distance from the antennas

A photo of the set-up in the anechoic chamber used for speed measurement tests is shown bellow:



Fig. 15. View of experimental setup in the anechoic chamber for speed measurements

We capture the output screen of the software we developed in Figure 16, showing the results with two active transponders moving in opposite directions with the same very low speed and, in Figure 17, a screen capture and a photo taken in order to compare the speed measured by the RFID system and the K Band radar gun.

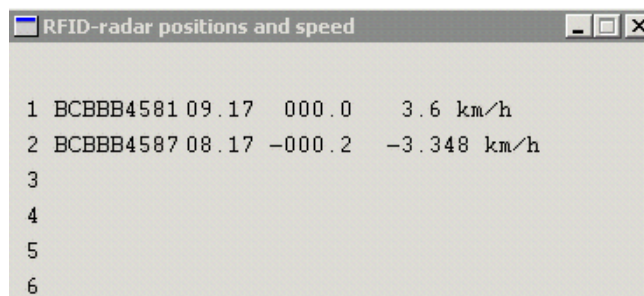

Fig. 16. Measurement screen showing two active transponders moving in opposite directions with the same speed

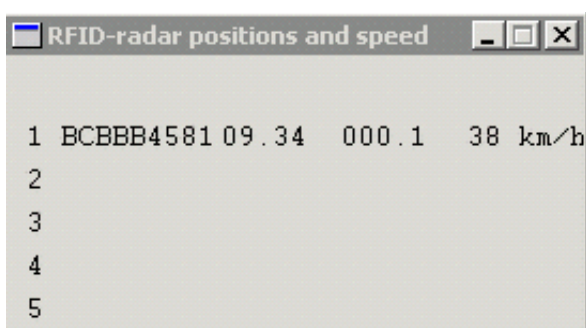

Fig. 17. Comparison between the speeds measured by the RFID system and a K-band radar

4.3 Theoretical and practical limitations for speed measurement

Considering the distance between the two receiving antennas of 31 cm (factory default), the system is able to solve angles between -30 and $+30$ degrees. The time spacing between two transponder transmissions is, as in Figure 2, about 333 milliseconds (three transmissions per second). Assuming that a transponder is moving such that the distance to the antenna system is constant, one can calculate the maximum theoretical speed that may be measured by using only the angle of arrival information. We also assume that we read two times the transponder in the whole working range of 60 degrees, the minimum information needed to compute the speed. If the reader does not receive the second transmitted signal, due to propagation issues, the speed can not be computed. The software will initiate a new measurement sequence by acquiring a new transponder ID. Table 1 presents a summary of the theoretical maximum speed as a function of the distance from the transponder to the antennas.

Distance to the antenna system (meters)	10	20	30	40	50
Distance traveled by the transponder (meters)	5.8	11	17	23	28
Speed (km/h)	62	124	187	249	311

Table 1. The theoretical maximum speed as a function of the distance between the transponder and the antenna system

In practical cases, more than two transmissions will be necessary in order to compute and have trusted information regarding the speed. Moreover, by reducing the angle between

two transmission points, let us say the system is not able to process the information in a timely manner or the radio signal is disturbed/attenuated due to propagation, the maximum measurable speed is much lower.

For the tests we made in a laboratory-controlled environment, with very low RF noise floor, we obtained the results presented in Table 2.

Distance to the antenna system (meters)	10	20	30	40	50
Speed (km/h)	6	24	32	36	n/a

Table 2. The maximum measured speed as a function of the distance between the transponder and the antenna system

Due to propagation issues generated by multiple reflections, we were not able to measure transponder speeds for distances over 40 meters.

5. Electromagnetic compatibility measurements on the RFID location system

We made a set of two measurements, one using a portable equipment for radiated emissions safety measurements (Narda SRM-3000) and a real life outdoor set-up and one using a certified set-up in an ISO 17025 accredited Electromagnetic Compatibility Laboratory - emclab.ro.

The RFID system we used for location and speed measurements is supposed to use a central frequency of 870.00 MHz with a bandwidth of 10 kHz. The frequency was chosen intentionally in order to be outside the GSM 900 band used in Europe (880.0 MHz - 915.0 MHz / 925.0 MHz - 960.0 MHz).

As we might see in the capture from the spectrum analyzer (see Figure 18), the electric field strength, at distance of 20 m in front of the reader antenna, is about 1.2 V/m, a value sufficiently low to be in accordance with the EMC safety levels in Europe and in the US. There are also visible, above the RF noise floor, the emissions from the GSM base stations (at 940 MHz and 960 MHz) located at about 600 meters from the location the tests were made.

Problems appear right in front and very close to the antenna system. In Figure 19 we have the field strength at a distance of 3 meters in front of the antennas. At this distance the emission level is about 39 V/m, a value high enough to worry. At about 30 cm near the emission antenna the field was about 200 V/m, the maximum value the spectrum analyzer could measure.

Regarding the bandwidth of the signal, we observe to be in the range of 10 to 25 kHz, small enough not to produce interference with other radio spectrum users. If many such devices are to be used simultaneously, on different central frequencies, there will be no problem if the spacing between to channel will be as low as 30 kHz.

A second set of measurements were made in an ISO 17025 accredited laboratory, using a certified set-up. The radiated emissions measurements have been made in a 3 m TDK semi-anechoic chamber using a Rohde & Schwarz - ESU 26 EMI Test Receiver, calibrated antennas and cables. The turntable and the antenna mast were operated by using an in-house made software program. Two international standards specify the emissions level and the performance characteristics of SRD-RFID equipments respectively: EN 55022 (CISPR 22) - "Information technology equipment - Radio disturbance characteristics - Limits and methods of measurements" for the emissions and EN 300-220 - "Electromagnetic

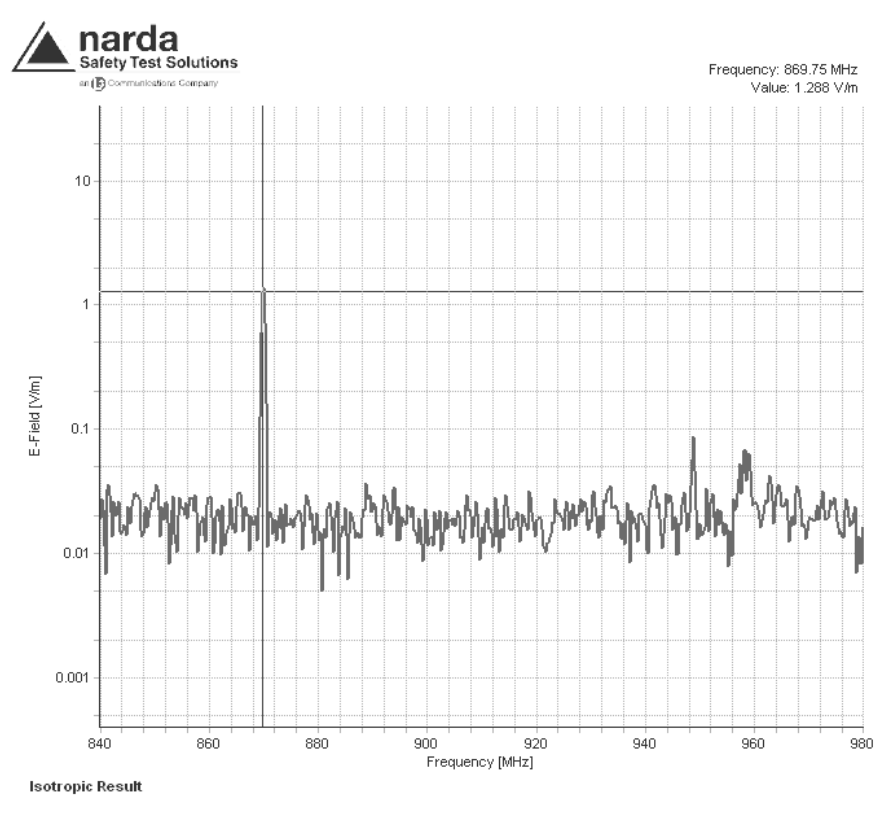

Fig. 18. Electric field magnitude at 20 m distance in front of the antenna

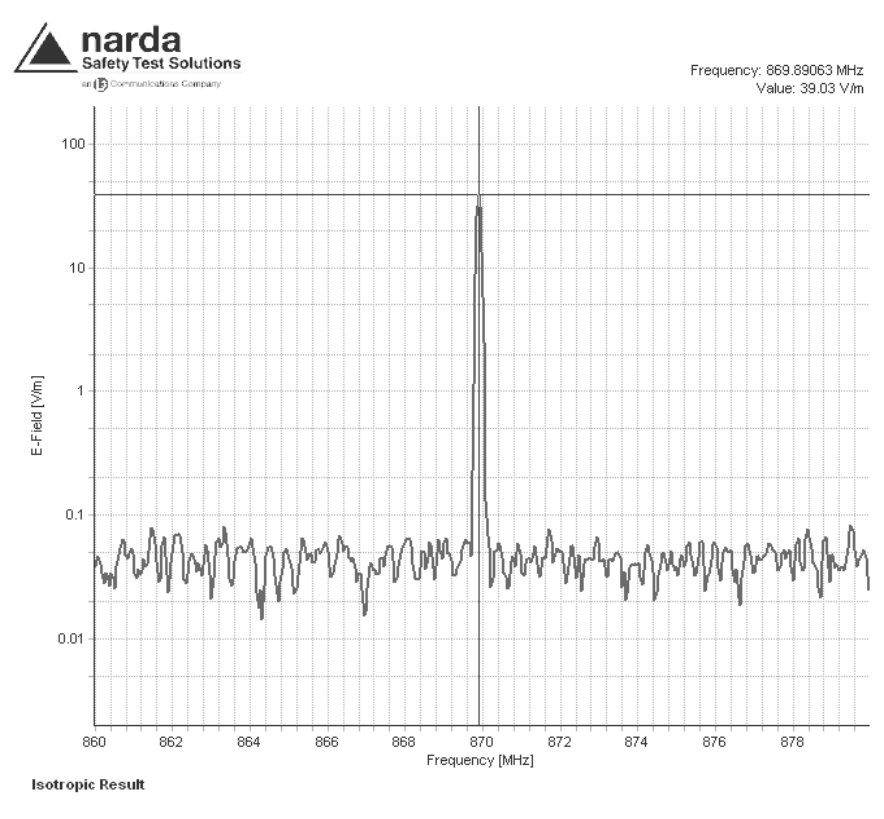

Fig. 19. Electric field magnitude at 3 m distance in front of the antenna

compatibility and Radio spectrum Matters (ERM); Short Range Devices (SRD)" for the operating performances and functional characteristics. A standard configuration was used for the test, as the equipment to be measured (EUT - Equipment Under Test) was positioned on a turn table at 0.8 meters above the ground and at 3 meters distance from the receiving antenna tip. During the measurements, the receiving antenna moved from 1 m to 4 m height and the EUT rotated 360 degrees, to find out the maximum emission level in the 30 to 1000 MHz band (as specified in the standards, in the final scan procedure, the operating frequencies were excluded from the measurement interval). We placed the transponders just in front of the RFID Radar antenna system. As stated in the standards above, the readings were made continuously, one measure per second using quasi-peak and peak detectors for the pre-scan and the final scan measurements respectively.

Table 3 shows the levels measured using this setup (we preserved also the peaks from the operating frequency range in order to compare them with the peaks outside this band and with the results from the first outdoor set-up). The limits used for calculations (QP Margin column) were 40 dB for 30 to 230 MHz and 47 dB for 230 MHz to 1000 MHz (as stated in CISPR 22 for 3 m test distance we have to add 20 dB per decade). We observe that outside the operating frequency band the emissions were below the limits with one notable

Freq (MHz)	Pol.	Tbl. Ang. (deg)	QP (dBuV)	Freq. peak (MHz)	QP Margin (dB)	QP Trace (dB)
188.7	H	65.5	33.20	184.01	-6.80	18.21
202.5	V	44.2	33.98	194.61	-6.02	18.11
865.2	H	18.2	89.00	869.91	42.00	65.36
865.2	V	153.2	72.54	869.91	25.54	48.90
867.0	H	17.7	88.70	869.92	41.70	65.06
867.0	V	150.5	42.38	869.92	-4.62	18.74
868.3	H	18.5	80.43	869.97	33.43	56.79
869.3	H	17.4	72.57	870.00	25.57	48.93
869.3	V	150.9	55.89	870.00	9.11	32.25
869.9	H	18.8	89.46	869.90	42.46	65.82
869.9	V	152.0	72.85	869.90	25.85	49.21
945.6	H	12.6	133.10	945.75	86.10	109.17
945.8	V	62.0	117.61	945.80	70.61	93.68

Table 3. The emission levels measured in the semi-anechoic chamber at 3 meters distance from the RFID Radar.

exception, at 945 MHz, where the electric field magnitude was over the limits specified in the standards. For the main operating frequency band, the emissions were very high, causing possible EMI problems for other electrical equipments operating nearby.

Regarding the safety aspects, there are problems due to very high emissions level, the field intensity measured being well higher than the maximum values permitted by the standard. In ETSI EN 300 220-1 V2.2.1 (2008-04) - Electromagnetic compatibility and Radio spectrum Matters (ERM), the power limit for devices operating between 30 MHz and 1.000 MHz, for all the bands reserved for short range devices, is 500 mW. There are other regulations in the EU where power levels up to 2 Watts are permitted for RFID systems with non/modulated carrier. Due to the operating principle, the RF power generator operating continuously, long time exposure to the EM field produced by the antenna RFID Radar system could be dangerous for humans.

6. Conclusion

RFID location systems for indoor and outdoor positioning are a promise for the future, even the performances of these systems are affected by many factors. We identified here that for a system working in the RF band near 900 MHz, the objects interposed between the antenna system and the tags to be located may have a great influence in terms of accuracy of the measurement results.

In closed areas multiple reflection paths may disturb the measurement systems, a percent of only 40 to 60 of total measurements are enough accurate to locate an object. In such conditions, there are small chances for this kind of systems to be used for high precision indoor applications requiring more than several tens of centimetres accuracy. The results obtained from the measurements we made in open area test sites are more promising, more than 93 percent of total result were not affected by notable errors.

For speed measurement of mobile objects by using RFID systems, we may conclude there are many aspects to solve before such systems may be used in commercial applications. Despite the precision for both passive and active transponders positioning is in the range of 10-30 centimetres for methods based on the time of arrival and angle of arrival, the performances obtained for speed measurements are not good enough when a large number of mobile objects are simultaneously in range. For a single transponder or a reduced number of transponders and small speeds, below 40 km/h, the speed measurement errors were below 30 %. For better speed measurement results we must combine the use of a RFID system for reading IDs and transponder internal memory contents with a classical radar system and process the results in a software interface.

Regarding the EMC aspects of this RFID location system, we may say, based on measurements presented here, that the electric field are high enough not to use this system indoors at distances less than 5 meters, if humans are present on a regular basis in that area. For applications in open areas, like access control for auto vehicles and many similar others, this kind of systems are very good.

7. References

- Bahl, P.; Venkata, N.; Padmanabhan, N. & Balachandran, A. (2000). "Enhancements to the RADAR user location and tracking systems" *Microsoft Research Technical Report MSR-TR-2000-12*, February 2000
- Coca, E. & Popa, V. (2007). "Experimental Results and EMC Considerations on RFID Location Systems", *Proceedings of the 1st International RFID Eurasia Conference*, 4-6

- September 2007, Istanbul, Turkey, pp. 279-283, ISBN 978-975-01566-0-1, Digital Object Identifier 10.1109/RFIDEURASIA.2007.4368138
- Coca, E.; Popa, V.; Găitan, V.; Turcu, C. O. & Turcu, Cr. (2008). "Speed Measurement of a Moving Object by Using a RFID Location System and Active Transponders", *Electronics and Electrical Engineering*, Lithuania, Nr. 8(88), 2008, ISSN 1392-1215
- Van Diggelen, F. & Abraham, C. (2001). "Indoor GPS Technology", CTIA, Dallas, Texas, USA, May 2001
- Evennou, F. & Marx, F. (2006). "Advanced Integration of WiFi and Inertial Navigation Systems for Indoor Mobile Positioning", *EURASIP Journal on Applied Signal Processing*, vol. 2006
- FCC (1996). Docket no. 94-102, "Revision of the commission's rules to ensure compatibility with enhanced 911 emergency calling", *Tech. Rep. RM-8143*, July 1996
- Finkenzeller, K. (2003). "RFID Handbook: Fundamentals and Applications in Contactless Smart Cards and Identification" John Wiley & Sons, New York, NY, USA, 2nd edition, 2003
- Fontana, R. J. (2008). "Recent Applications of Ultra Wideband Radar and Communications Systems", <http://www.multispectral.com>
- Gillieron, P.Y. & Merminod, B. (2003). "Personal navigation system for indoor applications", *Proceedings of the 11th IAIN World Congress*, Berlin, Germany, October 2003.
- Gillieron, P.Y.; Buchel, D. & Spassov, I. (2004). "Indoor navigation performance analysis", *Proceedings of the 8th European Navigation Conference (GNSS '04)*, Rotterdam, The Netherlands, May 2004
- Hightower, J. & Borriello, G. (2001). "A survey and taxonomy of location systems for ubiquitous computing" *Tech. Rep. UWCSE 01-08-03*, University of Washington, Washington, DC, USA, August 2001
- D'Hoe, K.; Van Nieuwenhuyse, A.; Ottoy, G.; De Strycker, L.; De Backer, L.; Goemaere, J. & Nauwelaers, B. (2009). "Influence of Different Types of Metal Plates on a High Frequency RFID Loop Antenna: Study and Design", *Advances in Electrical and Computer Engineering*, ISSN Print 1582-7445, ISSN On-line 1844-7600, vol. 9, no. 2, pp. 3-8, 2009. doi: 10.4316/AECE.2009.02001
- De Luca, D.; Mazzenga, F.; Monti, C. & Vari, M. (2006). "Performance Evaluation of Indoor Localization Techniques Based on RF Power Measurements from Active or Passive Devices", *EURASIP Journal on Applied Signal Processing*, vol. 2006, Article ID 74796, 11 pages, 2006. doi:10.1155/ASP/2006/74796
- Ni, L. M.; Liu, Y. & Patil, A. P. (2003). "LANDMARC: Indoor Location Sensing Using Active RFID", *Proceedings of the First IEEE International Conference on Pervasive Computing and Communications (PerCom'03)*, pp. 407-415, 2003
- Priyantha, N. B.; Chakraborty, A. & Baladrishnan, H. (2000). "The cricket location-support system", *Proceedings of the 6th Annual International Conference on Mobile Computing and Networking (MOBICOM '00)*, pp. 32-43, Boston, Mass, USA, August 2000

Wolfe, G.; Wertz, P. & Landstorfer, F. M. (1999). "Performance, accuracy and generalization capability of indoor propagation models in different types of buildings," in *Proceedings of 10th IEEE International Symposium on Personal, Indoor and Mobile Radio Communications (PIMRC '99)*, Osaka, Japan, September 1999

IntechOpen

IntechOpen



**Radio Frequency Identification Fundamentals and Applications
Bringing Research to Practice**

Edited by Cristina Turcu

ISBN 978-953-7619-73-2

Hard cover, 278 pages

Publisher InTech

Published online 01, February, 2010

Published in print edition February, 2010

The number of different applications for RFID systems is increasing each year and various research directions have been developed to improve the performance of these systems. With this book InTech continues a series of publications dedicated to the latest research results in the RFID field, supporting the further development of RFID. One of the best ways of documenting within the domain of RFID technology is to analyze and learn from those who have trodden the RFID path. This book is a very rich collection of articles written by researchers, teachers, engineers, and professionals with a strong background in the RFID area.

How to reference

In order to correctly reference this scholarly work, feel free to copy and paste the following:

Valentin Popa, Eugen Coca and Mihai Dimian (2010). Applications of RFID Systems - Localization and Speed Measurement, Radio Frequency Identification Fundamentals and Applications Bringing Research to Practice, Cristina Turcu (Ed.), ISBN: 978-953-7619-73-2, InTech, Available from:

<http://www.intechopen.com/books/radio-frequency-identification-fundamentals-and-applications-bringing-research-to-practice/applications-of-rfid-systems-localization-and-speed-measurement>

INTECH
open science | open minds

InTech Europe

University Campus STeP Ri
Slavka Krautzeka 83/A
51000 Rijeka, Croatia
Phone: +385 (51) 770 447
Fax: +385 (51) 686 166
www.intechopen.com

InTech China

Unit 405, Office Block, Hotel Equatorial Shanghai
No.65, Yan An Road (West), Shanghai, 200040, China
中国上海市延安西路65号上海国际贵都大饭店办公楼405单元
Phone: +86-21-62489820
Fax: +86-21-62489821

© 2010 The Author(s). Licensee IntechOpen. This chapter is distributed under the terms of the [Creative Commons Attribution-NonCommercial-ShareAlike-3.0 License](#), which permits use, distribution and reproduction for non-commercial purposes, provided the original is properly cited and derivative works building on this content are distributed under the same license.

IntechOpen

IntechOpen