

We are IntechOpen, the world's leading publisher of Open Access books Built by scientists, for scientists

5,500

Open access books available

135,000

International authors and editors

165M

Downloads

Our authors are among the

154

Countries delivered to

TOP 1%

most cited scientists

12.2%

Contributors from top 500 universities



WEB OF SCIENCE™

Selection of our books indexed in the Book Citation Index
in Web of Science™ Core Collection (BKCI)

Interested in publishing with us?
Contact book.department@intechopen.com

Numbers displayed above are based on latest data collected.
For more information visit www.intechopen.com



A Multi-Agent Expert System for Steel Grade Classification Using Adaptive Neuro-fuzzy Systems

Mohammad Hossein Fazel Zarandi¹, Milad Avazbeigi¹,
Mohammad Hassan Anssari² and Behnam Ganji¹

¹*Amirkabir University of Technology,*

²*University of Tehran*

Iran

1. Introduction

Iron and steel industry is a crucial basic section for most of the industrial activities. This industry provides the primary materials for construction, automobile, machinery and many other businesses. Furthermore, the iron and steel manufacturing is highly energy consuming. The influence of an efficient process control on the cost and energy reduction and environmental effects in iron and steel industry makes the process control one of the main issues of this industry.

Iron and steel industry should mainly rely on the new integrated production processes to improve productivity, reduce energy consumption, and maintain competitiveness in the market. Without rational process controlling systems, the potential benefits of new production processes can't be fully realized. Process control is the key function in the production management. Furthermore, a high degree of real-time operation and dynamic adjustment capabilities is required. In particular, the coordination of different production stages must be considered so as to achieve overall goals of the entire production processes.

In most steel companies, the principal production planning and scheduling techniques have been essentially manual techniques with little computerized decision support. These manual techniques are mainly based on the know-how and the experiences of those experts who have worked in a plant for years. Considering the above mentioned characteristics of a steel manufacturing, some important characteristics of this area can be summarized as:

- Steel manufacturing is a multi-stage process, logically and geographically distributed, involving a variety of production processes (Ouelhadj et al., 2004);
- In a steel grade classification, an operator has to determine the amount of additive materials in steel-making process. This is mainly based on the know-how and the professional experience of experts who have worked in the plant for years;
- A high degree of real-time operation and dynamic adjustment capabilities is required;
- The output of some stages is usually the input of some other stages, so integration is mandatory;
- The percentage of elements in steel-making usually has a fuzzy nature

Source: Expert Systems, Book edited by: Petrică Vizureanu,
ISBN 978-953-307-032-2, pp. 238, January 2010, INTECH, Croatia, downloaded from SCIYO.COM

According to the above characteristics of the steel manufacturing, a steel automation system is needed to represent distribution and integration existing in this industry. A fuzzy multi-agent expert system can provide such capabilities.

In the literature, there are only a few scientific papers and technical reports which are related directly to the design and development of intelligent expert systems for iron and steel industry. Perez De La Cruz et al. (1994) presents an expert system which is designed for the problem of identifying a steel or cast iron from a microphotograph. However, the essential aim of the implemented system is to help metallography students in the task of learning the concepts relevant for identifying and classifying steels and cast irons. Kim et al. (1998) presents an application of neural networks to the supervisory control of a reheating furnace in the steel industry. Also there are some papers concentrating on the scheduling of different steel making processes like casting, rolling, scrap charge using fuzzy multi-agent systems (Cowling et al., 2003; Cowling et al., 2004; Lahdelma & Rong, 2006; Ouelhadj et al., 2004). Finally, Fazel Zarandi and Ahmadpour (2009) present a fuzzy multi-agent system for steel making process. Each process of electric arc furnace steel making is assigned to be an agent, which works independently whilst coordinates and cooperates with other acquaintance agents. Adaptive neuro-fuzzy inference system (ANFIS) is used to generate agents' knowledge bases.

Most of the previous researches are related to the scheduling and coordination of steel making processes while our attempt is mainly about the steel grade classification. This chapter presents a new multi-agent expert system based on adaptive neuro-fuzzy inference system to help an operator to determine the amount of additive materials in steel-making process. Since the percentage of elements in steel-making usually has a fuzzy nature, the fuzzy rule sets and adaptive neuro-fuzzy systems are more accurate and robust to model this complex problem.

In the design of the adaptive neuro-fuzzy systems, determination of the appropriate number of the rules is critical. In other words, large number of rules increases the complexity of the systems exponentially. In this research, to estimate the optimal number of rules, first a clustering algorithm is presented based on the historical data of steel grade process. Moreover, appropriate values for the parameters of clustering algorithm including the number of rules and membership functions of fuzzy rule set are determined using an iterative procedure.

Here, an agent named "Clustering Agent" carries clustering procedure using the initial random membership functions obtained by another agent named "Initiator Agent".

The output of the "Clustering Agent" is cluster centers and the initial values of membership functions in fuzzy rule set. This output is used as the input to the adaptive neuro-fuzzy agents. These agents apply ANFIS to tune the obtained fuzzy rule set generated by clustering agent. ANFIS combines the advantages of fuzzy rule sets and neural networks capability of learning and hence provide a powerful tool of modeling fuzzy systems. In the proposed multi-agent system, five agents are responsible for implementation of ANFIS for different additives, each of which is responsible for each additive.

The cooperation of agents forms a fuzzy expert system which can help the operator to determine the suitable amount of additive materials in steel-making process.

The multi-agent expert system is programmed and simulated using Matlab. For three grade of steel including CK45, C67 and 70CR2 historical data are applied first for extraction of fuzzy rules using the "Clustering Agent" and "Initiator Agent", and then for tuning the ANFIS agents.

2. Steel making process

Iron and steel plants and their components are usually large-scale and very complex. In order to improve quality and productivity, many techniques have been developed combining the computer system and control theory and expert system. To overcome the complexity, the problem can be divided into some small sub-problems. In this chapter a model for steel grade classification in pneumatic steel making method (converter) is proposed. In this section, first the steel making process is briefly presented and then, in the next sections our proposed model is explained.

The steel manufacturing involves many processing stages and diverse technologies. In Fig. 1 the sub-processes of steel making process are shown (Council on Wage and Price Stability, 1977).

- **Coke production:** Coke is produced independently and is charged to blast furnace as one of the raw materials.
- **Sintering plant:** Iron ore is roasted with coke and limestone to produce a clinker.
- **Blast Furnace:** In the blast furnace the sintered ore is converted into the pig iron. With blowing hot air and fuel from bottom of furnace and charging sintered iron ore, and coke from top of furnace pig iron produce in the bottom of furnace. Pig iron transported in open ladles to metal mixers.
- **Steel Production:** Pig iron is smelted to steel. Steel in LD steel works. The steelmaking processes consist of three stages: steel-making, refining, and continuous casting.

In steel making stage, carbon, sulphur, silicon, and other impurity contents of molten iron are reduced to desirable levels by burning with oxygen in a converter or Electric Arc Furnace. The output from the stage is molten steel with the main alloy elements. To obtain the different grades of steel, some materials are charged in LD or EAF. These materials are called additives of alloying metals. These alloying metals tune the percentage of the elements such as carbon, manganese, aluminium, and etc. For fine-tuning the molten steel from the steel-making process is poured into ladle furnace (LF) by a crane. The operator at this stage further refines the chemicals and eliminates impurities in molten steel or adds the required alloy ingredients.

After refining, molten steel is poured into a tandish for casting. In the casting stage, molten steel flows down from a hole at the bottom of the tandish into the crystallizer. The last process is rolling.

Alloying in steel-making process and grade classification is a very important stage. In order to omitting human errors, an expert system is proposed to help an operator to determine the amount of additives.

3. Proposed multi-agent system

The proposed multi agent system has three types of agents including:

- Initiator agent which provides the input for the clustering agents. The output of the initiator agent is a set of the initial membership functions generated randomly.
- Clustering agent which carries clustering procedure using the initial random membership functions obtained by another agent named initiator agent.
- ANFIS agents apply ANFIS to tune the obtained fuzzy rule set generated by clustering agent. ANFIS combines the advantages of fuzzy rule sets and neural networks capability of learning and hence provide a powerful tool of modeling fuzzy systems. In the proposed multi-agent system, five agents are responsible for implementation of ANFIS for different additives, each of which is responsible for each additive.

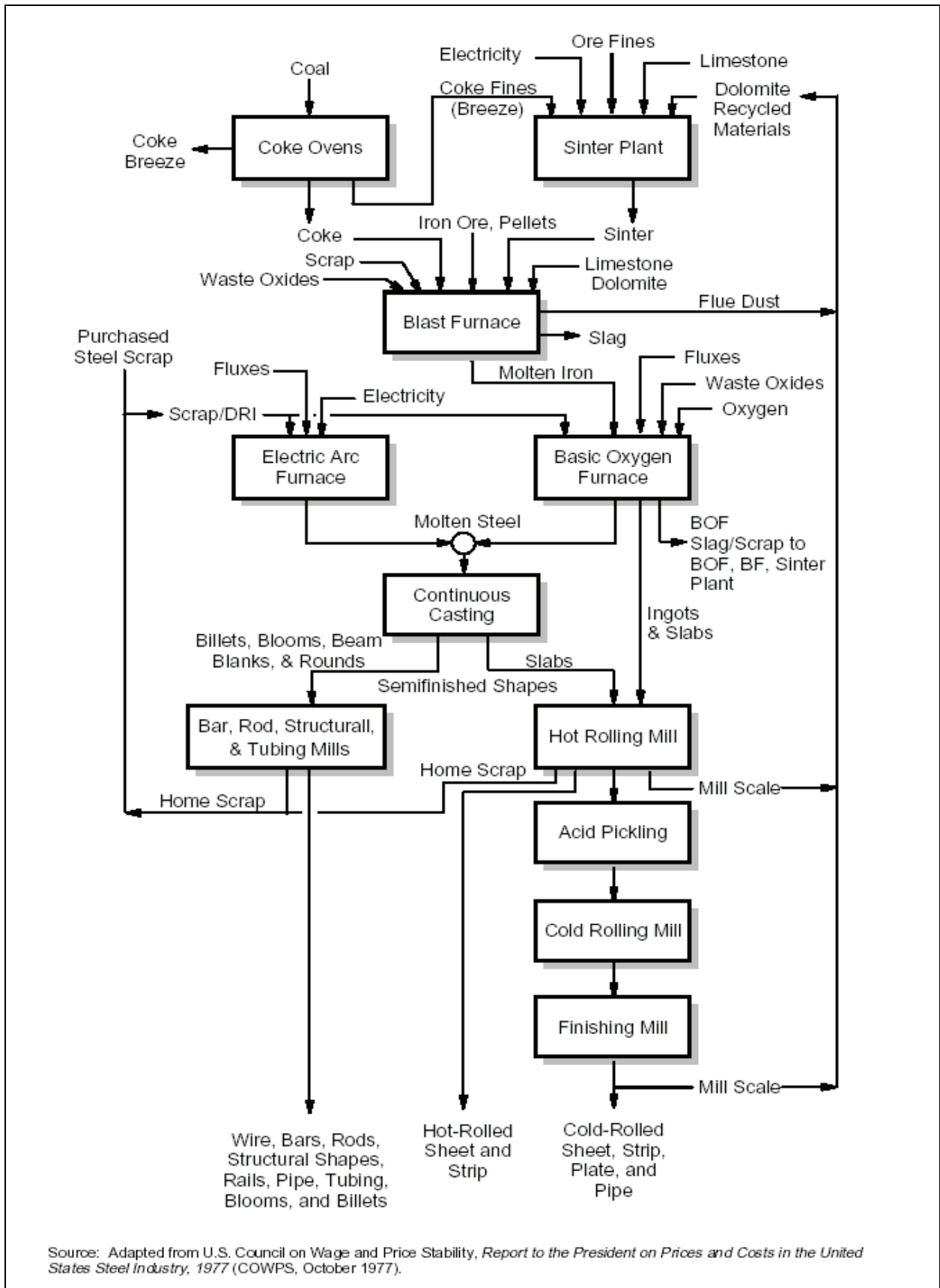

Fig. 1. Overview of steel making Process

The cooperation of agents forms a fuzzy expert system which can help the operator to determine the suitable amount of additive materials in steel-making process.

3.1 Initiator and clustering agents

The basic objective of the cluster analysis is to partition optimally the n unlabeled data points into c clusters base on a similarity measure. In crisp clustering, the separation of the clusters is sharp. However, in the real world problems, the separation of the clusters is usually fuzzy. Fuzzy clustering analysis has been extensively studied by many researchers (Bezdek & Pal, 1992; Huntsberger et Al., 1993; Moghaddam Zadeh & Bourbakis, 1997; Nguyen & Cohen, 1997; Pal & Ghosh, 1992). The most commonly used fuzzy clustering algorithm is fuzzy C-means (FCM), developed by Bezdek (1993). The objective function of FCM is defined as:

$$J(U, V; X) = \sum_{i=1}^c u_{ij}^m d_{ij}^2 \quad (1)$$

where, u_{ij} is membership function of element j in cluster i :

$$\sum_{i=1}^c u_{ij} = 1, \forall j = 1, \dots, n \quad (2)$$

where, V_i is the cluster center of fuzzy cluster i , $d_{ij} = \|x_j - v_i\|$ is the Euclidean distance between i -th cluster center and j -th data point; and m is a weighting exponent that determines the degree of fuzziness. The necessary conditions for equation (1) to reach its minimum are:

$$v_i = \frac{\sum_{j=1}^n u_{ij}^m x_j}{\sum_{j=1}^n u_{ij}^m} \quad (3)$$

$$u_{ij} = \left[\sum_{k=1}^c \left(\frac{d_{ij}}{d_{kj}} \right)^{\frac{2}{m-1}} \right]^{-1} \quad (4)$$

In a batch-mode operation, FCM determines the cluster center v_i and the membership matrix U using the following steps (Bezdek, 1993):

Step 1: Initialize the membership matrix U with random values between 0 and 1 such that the constraints in Equation (2) are satisfied.

Step 2: Calculate c fuzzy cluster center $v_i, i=1, \dots, c$, using Equation (3).

Step 3: Compute the Cost Function according to Equation (1).

Stop if either it is below a certain tolerance value or its improvement over previous iteration.

Step 4: Compute a new U using Equation (4). Go to step 2.

FCM suffers from some challenging problems such as unknown number of clusters, noise contaminated data and supervisory determining the u :

- The first is that the number c of clusters must be pre-defined and the resulting structure for the specified number of clusters is assumed to be the best. This is seldom the case in practice. Thus, the difficult problem encountered is the cluster validity, which is required to evaluate the quality of the c -partitions resulting from the algorithms.
- The second is that the FCM algorithm is sensitive to noise in the data. To solving this problem in many algorithms based on FCM, the m parameter is fixed in a predefined value (Bezdek, 1993).

To improve the performance of clustering various clustering validity indices have been proposed. However, most of them focus on improving robustness or extending the function of FCM (Krishnapuram & Keller, 1993; Pedrycz, 1996; Nasraoui & Krishnapuram, 1996; Fazel Zarandi et al., 2009). In this book chapter, an unsupervised clustering is proposed which allows initializing the u , automatic setting of optimal cluster number, and finding the most appropriate m .

The objective function of penalized Fuzzy c -means proposed by Yang and Su (1994) is defined as follows:

$$J = \frac{1}{2} \sum_{i=1}^c \sum_{j=1}^n (u_{ij})^m d_{ij}^2 - \frac{1}{2} \nu \sum_{i=1}^c \sum_{j=1}^n (u_{ij})^m \ln \alpha_i \quad (5)$$

where u_{ij} is the membership degree of the j -th data point X_j in the i -th cluster, d_{ij} is their distance, N is the total number of data and c the number of clusters to be found, α_i is a proportional constant for class j and $\nu \geq 0$ is a constant. When ν equals zero, we will have J_{FCM} .

Now consider the problem of minimizing J with respect to u_{ij} fuzzy, subject to $m > 1$ and the constraints (2).

As we know:

$$0 \leq u_{ij} \leq 1 \quad (6)$$

and this constraint may be eliminated by setting $u_{ij} = S_{ij}^2$ with S_{ij} real. We adjoin the constraints (2) and (6) to J with a set of Lagrange multipliers (λ_i) to give:

$$J = \sum_{i=1}^c \sum_{j=1}^n (u_{ij})^m d_{ij} - \nu \sum_{j=1}^c \sum_{i=1}^n (u_{ij})^m \ln \alpha_i + \sum_{j=1}^n \lambda_j \left(\sum_{i=1}^c u_{ij} - 1 \right) \quad (7)$$

$u_{ij} = S_{ij}^2$ then:

$$\frac{\partial J}{\partial S_{ij}} = 2m(d_{ij} - \nu \ln \alpha_i) S_{ij}^{2m-1} + 2S_{ij} \lambda_j \quad (8)$$

$$\frac{\partial J}{\partial S_{ij}} = 0 \quad \text{then:} \quad S_{ij}^{2(m-1)} = \frac{-\lambda_j}{m(d_{ij} - \nu \ln \alpha_i)} \quad (9)$$

By summing over j and using (2) the necessary conditions for Equation (7) to reach its minimum are:

$$\alpha_i = \frac{\sum_{j=1}^n u_{ij}^m}{\sum_{i=1}^c \sum_{j=1}^n u_{ij}^m} \quad (10)$$

$$v_i = \frac{\sum_{j=1}^n u_{ij}^m x_j}{\sum_{j=1}^n u_{ij}^m} \quad (11)$$

$$u_{ij} = \left[\sum_{l=1}^c \frac{(d_{ij}^2 - v_l n \alpha_l)^{1/(m-1)}}{(d_{il}^2 - v_l n \alpha_l)^{1/(m-1)}} \right]^{-1} \quad (12)$$

The objective function (5) has two main components. The first component is similar to the FCM objective function and has a global minimum when each data point is in a separate cluster. The global minimum of the second component can be achieved when all points are in the same cluster such that it controls the number of clusters.

According to (10), (11), (12) an iterative procedure is proposed for obtaining the optimal cluster centers. In this procedure, an unsupervised method is used for finding the membership matrix U , m and v . The program for finding the initial U is shown in Fig. 2.

Clusters can be found easier and with less number of iterations using the initial agent's program. The pseudocode of the clustering agent combining the initial agent's program is also shown in Fig. 3.

```

u=zeros(c, n);
sum = 0;
for j=1:n
    for i=1:c
        b(i) = rand;
    sum= sum+ b(i);
    end
for i=1:c
    u (i, j)=b(i)/sum;
end
sum=0;
end

```

Fig. 2. Pseudocode of the initial agent's program

Step 1: Set the initial values in the parameter of the algorithm, for instance $P=0.0001$, $v=0$ and $m=1.001$.

Step 2: Find the membership matrix, U with initial agent.

Step 3: Calculate α and V vectors by the Equations (10), (11).

Step 4: Find the distance matrix, D as follows:

$$d_{ij} = |x_j - v_i| \quad j=1, \dots, n \quad i=1, \dots, c \quad (13)$$

Step 5: Calculate the cost function J from Equation (5).

Step 6: If $|J - P| \leq \varepsilon$ go to step 11 Else go to step 7.

Step 7: $P=J$.

Step 8: From Equation (12) up to date the membership matrix, U .

Step 9: Keep the values of v , u , m , v , and α in new symbols.

Step 10: Go to step 3.

Step 11: $m=m+0.001$, and $v=v+0.001$.

Step 12: Compute J , D , α , and V from Equations of (5), (13), (10), and (11).

Step 13: If $|J - P| \leq \varepsilon$ stop. Else go to step 14.

Step 14: Keep the values of v , u , m , v , and α in new symbols.

Step 15: Go to step 3.

Fig. 3. Pseudocode of the clustering agent's program

So from algorithm we can find the cluster centers with optimal location and number. After running the algorithm we can merge some cluster center that they are the same or very near each other, but in our model we want to use these cluster centers for training, so we don't eliminate any of them and train our model with some repetitive data.

3.2 ANFIS agents

Neuro-fuzzy models have played an important role in the design of the fuzzy expert systems. However in most situations, the proper selection of the number, the type, and the parameters of the fuzzy membership function and rules are crucial for achieving the desired performance. The desired performance has yet been achieved through the trial and error. This fact highlights the significance of tuning of the fuzzy systems.

ANFIS is a fuzzy Sugeno network in the framework of adaptive systems facilitating learning and adaptation. Such a framework makes models more systematic and less relying on expert knowledge. To understand the ANFIS architecture, consider the following fuzzy system which has two rules and is a first order Sugeno model:

Rule 1:

$$\text{if } (x \text{ is } A_1) \text{ and } (y \text{ is } B_1) \text{ then } (f_1 = p_1x + q_1y + r_1) \quad (14)$$

Rule 2:

$$\text{if } (x \text{ is } A_2) \text{ and } (y \text{ is } B_2) \text{ then } (f_2 = p_2x + q_2y + r_2) \quad (15)$$

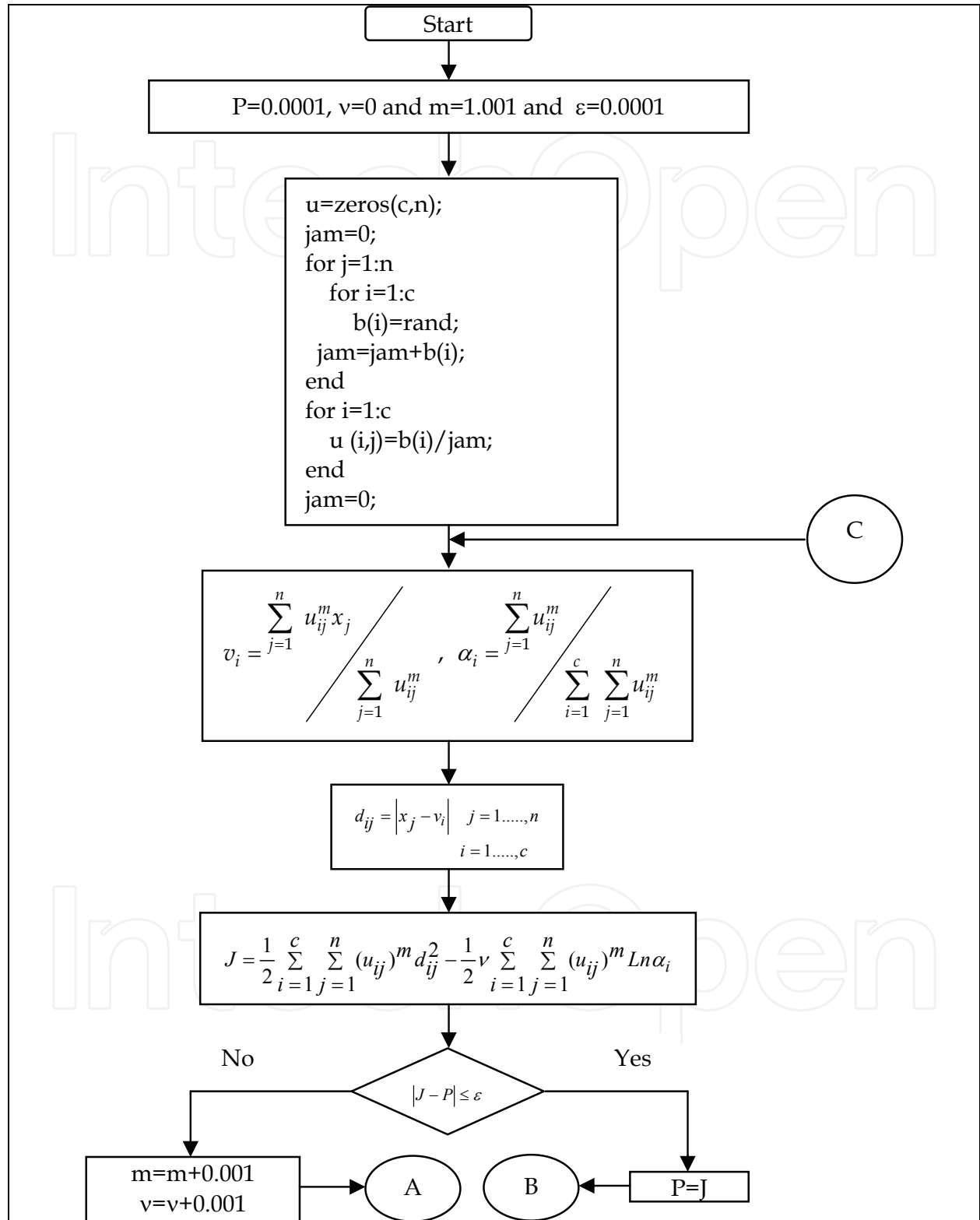

Fig. 4. Flowchart of the initiator and clustering agents' procedures (part I)

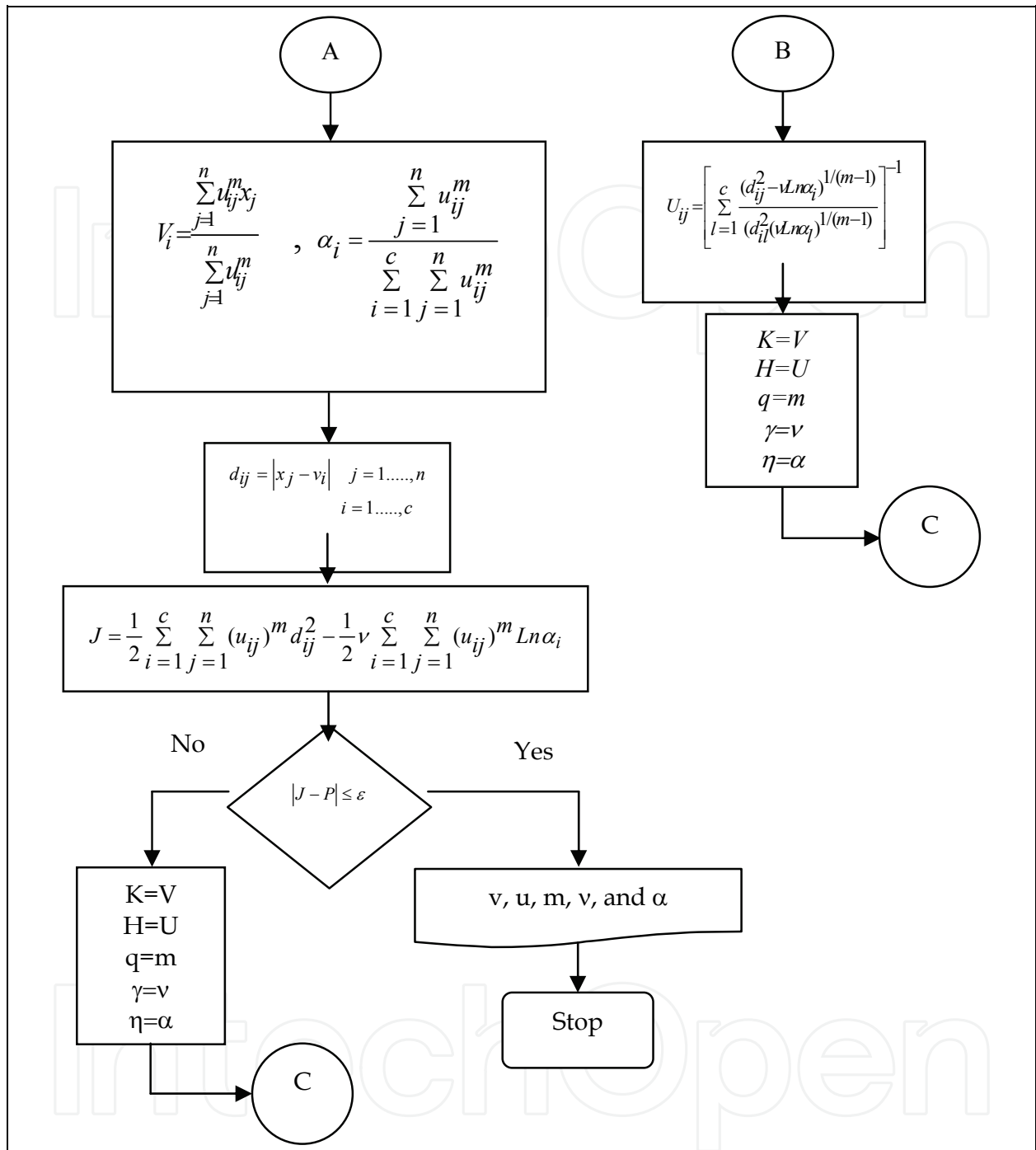

Fig. 4. Flowchart of the initiator and clustering agents' procedures (part II)

Several types of fuzzy reasoning have been proposed in the literature (Lee, 1990a and 1990b). Depending on the type of fuzzy reasoning and fuzzy if-then rules employed, most fuzzy inference systems can be classified into three types:

- The overall output is the weighted average of each rule's crisp output induced by the rule's firing strength (the product or minimum of the degrees of match with the premise part) and output membership functions. The output membership functions used in this scheme must be monotonic functions (Tsukamoto, 1979).

- The overall fuzzy output is derived by applying “max” operation to the qualified fuzzy outputs (each of which is equal to the minimum of firing strength and the output membership function of each rule). Various schemes have been proposed to choose the final crisp output based on the overall fuzzy output; some of them are centroid of area, bisector of area, mean of max, maximum criterion, etc (Lee, 1990a and 1990b).
- Takagi and Sugeno’s fuzzy if-the rules are used (Sugeno, 1985; Takagi and Sugeno, 1985). The output of each rule is a linear combination of input variables plus a constant term, and the final output is the weighted average of each rule’s output. A possible ANFIS architecture to implement these two rules is shown in Fig. 5. Note that a Circle indicates a fixed node whereas a square indicates an adaptive node (the parameters are changed during training). Here, O_{ij} denotes the output of node i in layer l .

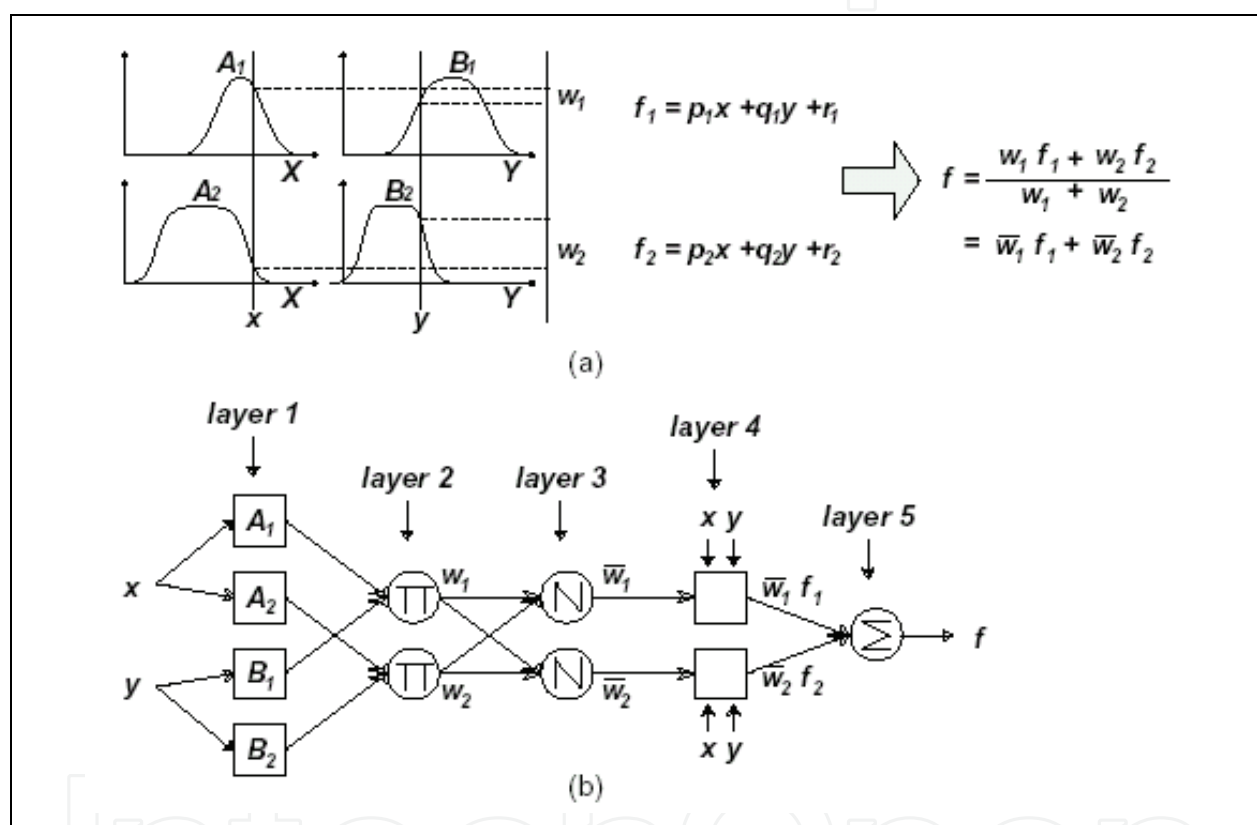

Fig. 5. ANFIS architecture

The explanation of the layers of ANFIS is as follows:

Layer 1: All the nodes in this layer are adaptive nodes. The output of each node is the degree of membership of the input of the fuzzy membership functions represented by the node:

$$O_{1,i} = \mu_{A_i}(x) \quad i = 1,2 \tag{16}$$

$$O_{1,i} = \mu_{B_i}(y) \quad i = 3,4 \tag{17}$$

where, A_i and B_i are any appropriate fuzzy sets in parametric form, and $O_{1,i}$ is the output of the node in the i^{th} layer. This study uses bell shape membership functions. A bell shape membership function can be shown as follows:

$$\mu_{A_i}(x) = \frac{1}{1 + \left[\frac{(x - c_i)^2}{a_i} \right]^{b_i}} \quad (18)$$

Here, a_i , b_i and c_i are the parameter for the membership functions.

Layer 2: The nodes in this layer are fixed (not adaptive). They are labelled by M to indicate that they play the role of a simple multiplier. The outputs of these nodes are given by:

$$O_{2,i} = w_i = \mu_{A_i}(x)\mu_{B_i}(y) \quad i=1,2 \quad (19)$$

The output of each node in this layer represents the firing strength of the rule.

Layer 3: Nodes in this layer are also fixed nodes. They are labelled by N to indicate that they perform a normalization of the firing strength from the previous layer. The Output of each node in this layer is given by:

$$O_{3,i} = \bar{w}_i = \frac{w_i}{w_1 + w_2} \quad i=1,2 \quad (20)$$

Layer 4: All the nodes in this layer are adaptive nodes. The output of each node in this layer is simply the product of the normalized firing strength and a first order polynomial (for first order Sugeno model):

$$O_{4,i} = \bar{w}_i f_i = \bar{w}_i (p_i x + q_i y + r_i) \quad i=1,2 \quad (21)$$

where p_i , q_i and r_i are design parameters (referred to as consequent parameters since they deal with the then-part of the fuzzy rule).

Layer 5: This layer has only one node labelled by S to indicate that it performs the function of a simple summation. The output of this single node is given by:

$$O_{5,i} = \sum_i \bar{w}_i f_i = \frac{\sum_i w_i f_i}{\sum_i w_i} \quad i=1,2 \quad (22)$$

The ANFIS architecture is not unique. Some layers can be combined and still produce the same output. In this ANFIS architecture, there are two adaptive layers (Layers 1 and 4). Layer 1 has three modifiable parameters (a_i , b_i and c_i) pertaining to the input MFs. These parameters are called premise parameters. Layer 4 has also three modifiable parameters (p_i , q_i and r_i) pertaining to the first order polynomial. These parameters are consequent parameters.

The task of the training or learning algorithm for this architecture is to tune all the modifiable parameters to make the ANFIS output match the training data. It should be noted that a_i , b_i and c_i describe the sigma, slope and center of the bell shape membership functions. If these parameters are fixed, the output of the network becomes:

$$\begin{aligned}
 f &= \frac{W_1}{W_1+W_2} f_1 + \frac{W_2}{W_1+W_2} f_2 \\
 &= \bar{W}_1 f_1 + \bar{W}_2 f_2 = \bar{W}_1 (P_1 x + q_1 y + r_1) + \bar{W}_2 (P_2 x + q_2 y + r_2) \\
 &= (\bar{W}_1 x +) P_1 + (\bar{W}_1 y) q_1 + (\bar{W}_1) r_1 + (\bar{W}_2 x) P_2 + (\bar{W}_2 y) q_2 + (\bar{W}_2) r_2
 \end{aligned} \tag{23}$$

which is a linear combination of modifiable parameters. Therefore, a combination of gradient descent and the least-squares method (hybrid learning rule as in Jang, 1991) can easily identify the optimal values for the parameters p_i, q_i are r_i . If the membership functions are not fixed and are allowed to vary, the search space becomes large and consequently, the convergence of the training algorithm becomes slower.

3.3 Merging ANFIS with clustering

Clustering techniques are primarily used in conjunction with radial basis function or fuzzy modeling to determine the initial location of the radial bases functions or fuzzy if-then rules.

For this purpose, clustering techniques are validated on the basis of two assumptions:

- The similar inputs to the target system which have to be modeled should produce the similar outputs.
- These similar input-output pairs are bundled into clusters in the training data set.

First assumption states that the target system to be modeled should be a smooth input-output mapping; this is generally true for the real-world systems. Second assumption requires that the data set has to conform to some specific type of statistical distribution functions. However, this is not always true and therefore clustering techniques used for structure identification in neural networks or fuzzy modelings are highly heuristic. That's why heuristic methods are widely used to overcome the problem.

Fuzzy or neuro-fuzzy systems define a rule for every inputs and outputs. For instance, in an ANFIS model with 10 inputs which every input is mapped to two membership functions, $2^{10}=1024$ rules can be formed, and with further inputs, and mapping to further MFs the number of rules increases exponentially. Hence, a data set can be partitioned into several groups with the similar properties and later these groups can be used as the training data for ANFIS. In our case we could develop a model with fewer rules than ANFIS.

4. Implementation, verification and validation of the multi-agent expert system for the steel grade classification problem

The basic oxygen process is characterized by three things:

- The use of gaseous oxygen as the sole refining agent.
- A metallic charge composed largely of blast furnace iron in a molten condition, thus greatly reducing the thermal requirements of the process.
- Chemical reactions that proceed quite in bath of comparatively low surface -to-volume ratio, thus minimizing external heat losses.

A schematic representation of progress of refining in top-blown vessel is shown in figure Fig. 6.

As the Fig. 6 shows the percent of elements are not crisp and they can be better modelled using fuzzy numbers. This is also valid for the final steel. That's why in this research the fuzzy methods are used for the clustering. The cluster centers are then used for training the ANFIS model.

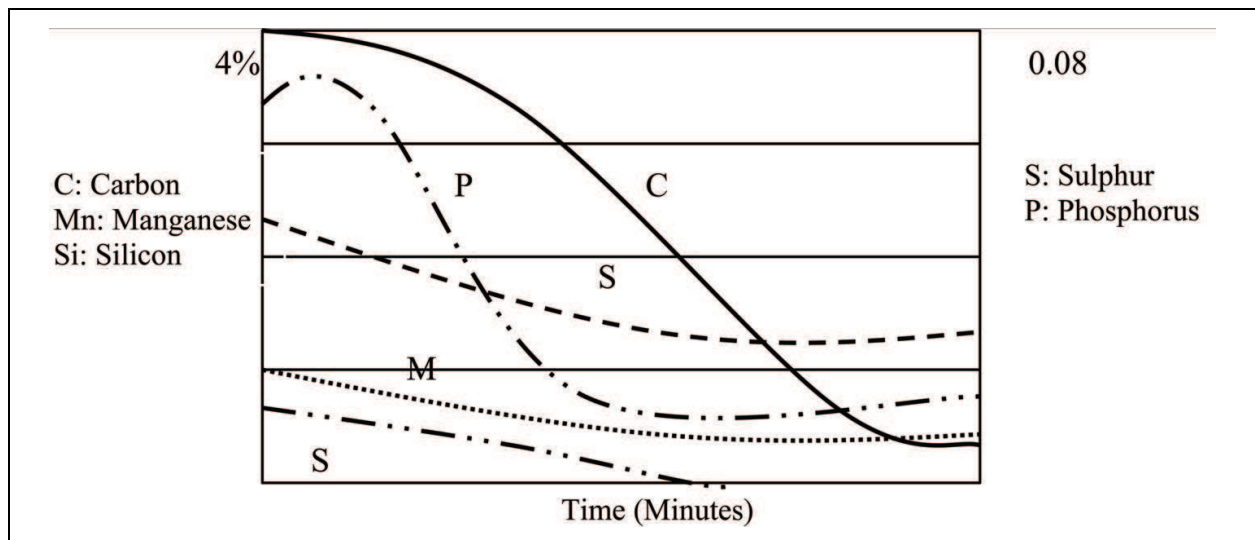

Fig. 6. Schematic representation of the progress of refining in top-blown vessel

About 200 data were collected in a matrix, named with the mark of steel. A sample of the collected data is shown below:

Steel Analyze in LD				Steel Analyze in LF						Amount of Additives				
C% *100	Mn% *100	P% *1000	Temp.	C% *100	Mn% *100	Si% *1000	P% *1000	S% *1000	Temp.	FeMn Kg	FeSi Kg	Al Kg	Granol Kg	SiCa Kg
12	37	31	1675	45	63	16	20	16	1670	770	290	06	590	190
16	20	24	1680	46	67	30	28	25	1675	850	539	15	540	440
14	23	26	1670	44	70	33	32	28	1665	845	593	18	540	490
12	19	28	1673	68	73	37	30	24	1670	970	665	14	650	565
15	25	26	1682	47	55	20	28	24	1678	540	360	14	580	260
11	21	28	1680	46	63	27	25	20	1675	760	485	10	630	385
09	21	27	1679	50	68	32	31	26	1674	845	575	16	740	475
10	21	24	1671	45	74	30	32	27	1668	953	540	17	700	440
08	15	28	1682	48	72	29	20	15	1677	1030	520	05	720	421
10	14	18	1677	43	53	25	21	17	1672	700	450	07	590	350
10	15	20	1673	47	58	28	27	20	1674	770	500	10	660	400
09	14	19	1674	45	62	22	28	22	1671	863	395	12	650	295
12	16	22	1670	44	67	33	29	21	1665	920	595	11	575	495
16	18	22	1680	46	69	38	30	30	1675	920	683	20	539	583
12	20	27	1671	50	73	20	32	18	1670	950	360	08	680	260
10	20	20	1679	49	72	21	30	19	1674	935	377	09	700	277

Table 1. Sample of collected data for CK45

According to the proposed algorithm the collected data are clustered and then the cluster centers ($C=10$) are saved in a matrix.

The values of the fuzzification parameters for 10 clusters are shown below. These parameters are related to the objective function of the clustering method.

m1	m2	m3	m4	m5	m6	m7	m8	m9	m10	m11	m12	m13	m14	m15
3.2	3.27	2.53	2.63	3.12	2.41	2.27	3.23	2.38	2.21	3.17	3.15	3.54	2.78	2.7

Table 2. Fuzzification parameters value

$V_i \approx .098, i=1, \dots, 15.$

All of these parameters are obtained by an unsupervised mode. If v equals zero, the cost function converts to Fuzzy c -mean's cost function. After the clustering, the cluster centers are used as the inputs for the ANFIS training. The number of rules in knowledge base and the running time decrease considerably by using the output of the clustering method as the input of the ANFIS.

C%	16.9959	15.0000	14.0000	16.9994	10.0091	9.0010	10.0005	14.8235	16.0000	16.9999
Mn%	20.9999	16.3357	21.0000	18.0000	14.0000	15.9940	16.0000	15.5730	15.0040	16.0000
P%	24.0020	28.0000	24.0000	29.8114	23.0002	28.2872	25.0000	30.0000	20.0128	25.0008
Temp.	73.0000	74.0003	78.7339	80.0000	80.0000	74.0047	73.4254	71.5233	74.0000	80.0000
C%	46.0120	42.0007	47.0000	48.9922	43.0278	44.9913	45.0000	43.0000	43.0000	48.0000
Mn%	73.0000	68.5728	65.8806	53.0642	69.0523	71.1385	71.4639	60.0000	66.0000	69.0000
Si%	27.0000	21.0000	30.0000	29.1963	20.0000	25.9769	21.0058	25.9270	23.0000	33.6949
P%	31.0000	30.9995	25.0000	29.8779	25.6069	24.0000	25.0000	25.0000	29.0000	26.0002
S%	28.0000	28.0000	27.0000	27.9538	28.0000	31.9940	25.0000	22.8422	22.1667	19.8773
Temp.	71.0000	74.9999	73.9558	70.0000	73.9979	70.0000	74.2199	77.4732	72.0974	72.0000
FeMn	92.4316	85.0000	85.0009	76.0001	82.9576	82.0001	95.0000	84.0000	86.4096	84.0000
FeSi	40.0000	54.0000	50.6572	53.9992	37.5990	58.1757	51.7653	49.6328	38.0000	53.9912
Al	20.0000	20.0000	6.2156	17.9602	23.9869	16.0000	18.0000	14.9998	3.0289	19.6295
Gran.	52.1006	63.9593	56.5167	66.0000	52.0000	55.5068	66.9999	69.9870	69.9992	61.3691
SiCa	26.0001	38.4433	58.2097	49.0000	49.0000	55.0000	31.6977	49.0000	40.6215	40.2289

Table 3. Input, Output, and Additive Elements Cluster matrix for CK45.

We use the training data in the following form:

$$\begin{aligned}
 y_1 &= [F_e M_n], U = [\underbrace{C\%, Mn\%, P\%, T}_{\text{Steel Analyzein LF}}, \underbrace{C\%, Mn\%, Si\%, P\%, S\%, T}_{\text{Steel Analyzein LD}}] \\
 y_2 &= [F_e S_i], U \\
 y_3 &= [Al], U \\
 y_4 &= [Gramol], U \\
 y_5 &= [S_i C_a], U
 \end{aligned}
 \tag{24}$$

U is the input and y_i ($i=1 \dots 5$) are the outputs (Additives). For simplicity the model is designed in multi-input single-output form (see Fig. 7-11 ANFIS training and test for 5 additives).

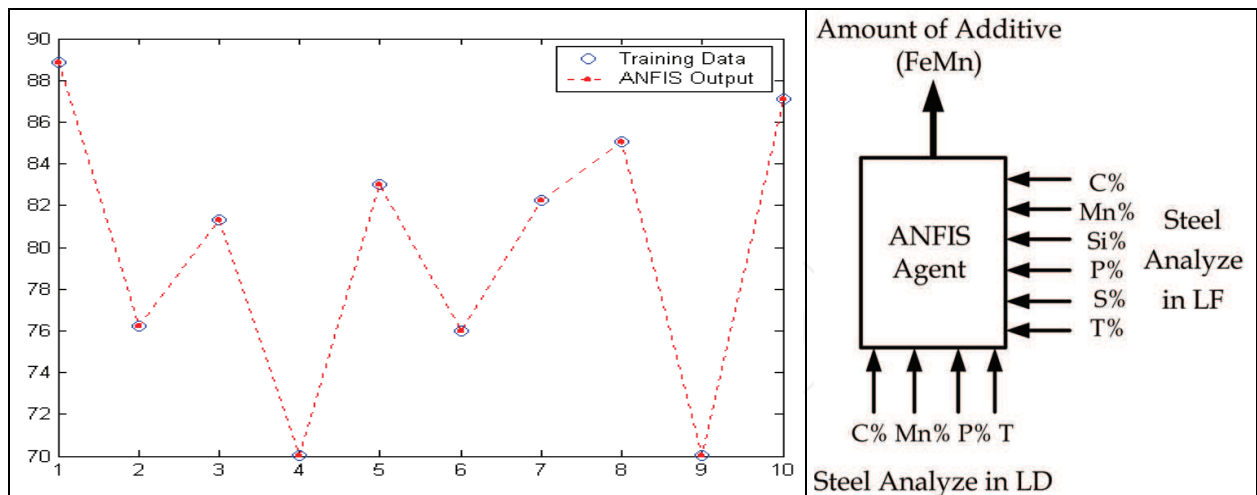

Fig. 7. Comparison of the training data output and the ANFIS Output and the architecture of the FeMn ANFIS agent

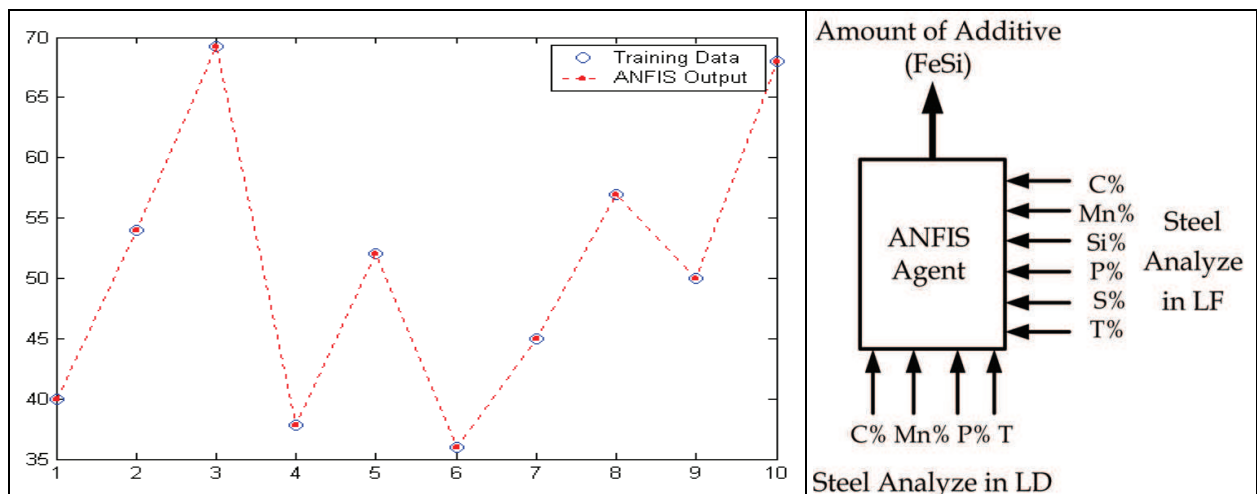

Fig. 8. Comparison of the training data output and the ANFIS Output and the architecture of the FeSi ANFIS agent

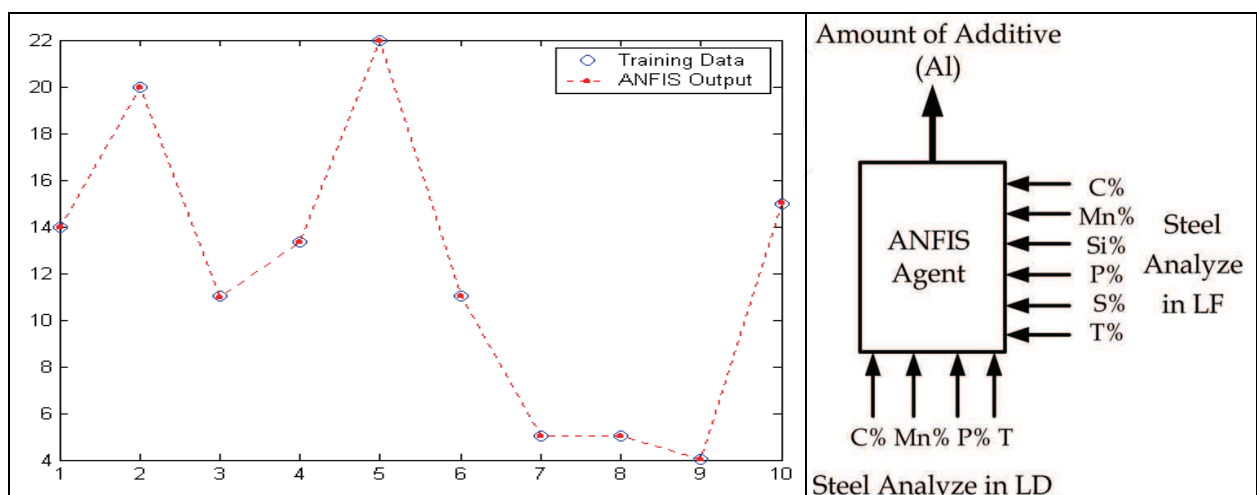

Fig. 9. Comparison of the training data output and the ANFIS Output and the architecture of the Al ANFIS agent

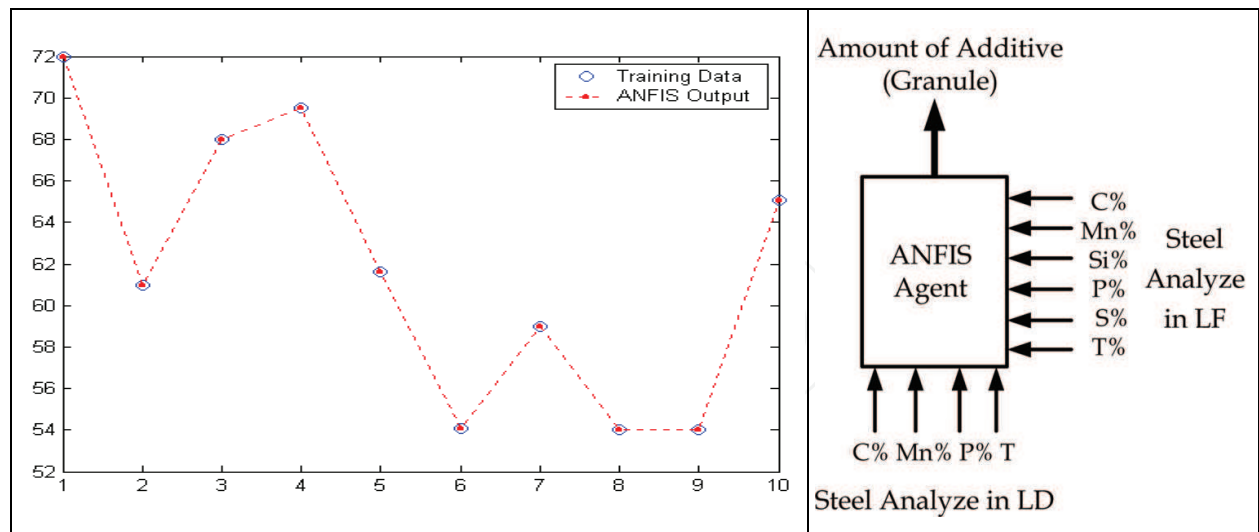

Fig. 10. Comparison of the training data output and the ANFIS Output and the architecture of the Granule ANFIS agent

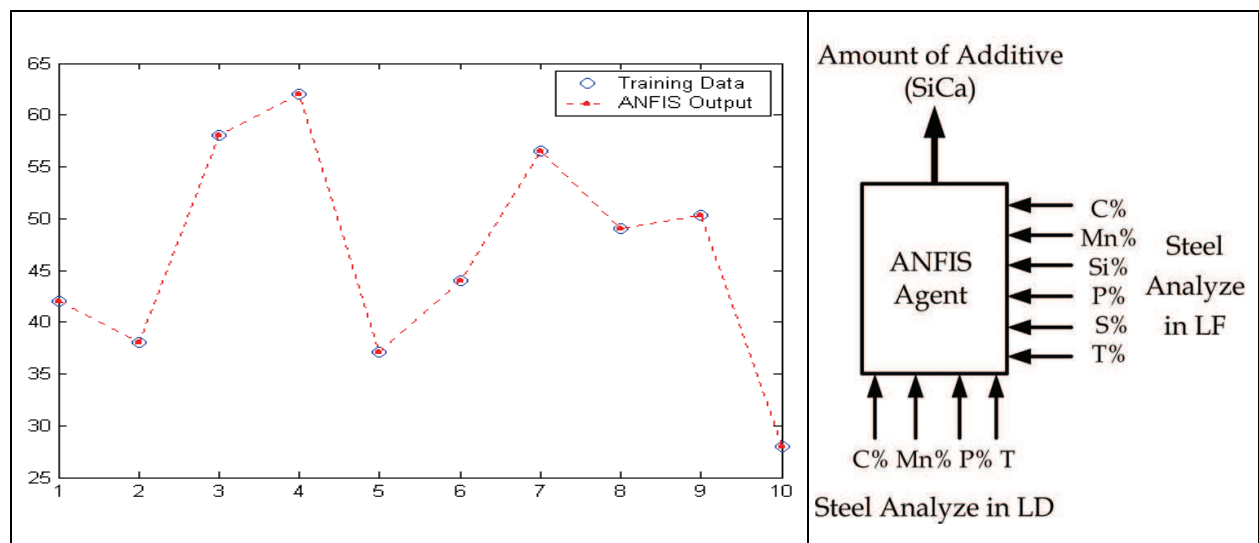

Fig. 11. Comparison of the training data output and the ANFIS Output and the architecture of the SiCa ANFIS agent

To show the performance of the designed multi-agent expert system, the system is applied to determine the value of the additives for CK45. The model has ten inputs according to table 4. As explained before, each additive amount is determined by a specialized agent. Each agent first uses the output of the initiator agent and the clustering agent to train its ANFIS. Then, it applies the trained ANFIS to determine the amount of the related additives. The Amounts of the additives are summarized in table 5.

C%	Mn%	P%	Temp.	C%	Mn%	Si%	P%	S%	Temp.
*100	*100	*1000	-1600	*100	*100	*1000	*1000	*1000	-1600
8.000	15.025	25.257	76.799	47.999	74.989	20.002	31.980	27.000	75.000

Table 4. Input parameters values for determination the additives of CK45

FeMn Kg	FeSi Kg	Al Kg	Granule Kg	SiCa Kg
939.082	497.827	15.312	633.155	448.793

Table 5. Output values of the additives of CK45

5. Conclusion

Iron and steel manufacturing is a crucial basic industry for most of the industrial activities. The influence of an efficient process control on the cost and energy reduction has made the process control one of the main issues of this industry. Iron and steel manufacturing should mainly rely on the new integrated production processes to improve productivity, reduce energy consumption, and maintain competitiveness in the market.

In the most steel companies, the principal production planning and scheduling techniques are essentially manual techniques with little computerized decision support. These manual techniques are mainly based on the know-how and the experiences of those experts who have worked in the plant for years. Moreover, steel production is a multi-stage process, logically and geographically distributed, involving a variety of production processes. Also, in a steel grade classification, an operator has to determine the amount of additive materials in steel-making process. Because of the above reasons, a steel automation system is needed to represent distribution and integration existing in this industry. A fuzzy multi-agent expert system can enable such capabilities.

This chapter proposes a multi-agent expert system includes three different types of agents:

- Initiator Agent: Provides the initial membership functions and cluster centers for the clustering agent.
- Clustering Agent: Produces the initial cluster centers for training of the ANFIS agents
- ANFIS Agents: By using ANFIS we can refine fuzzy if-then rules obtained from human expert to describe the input-output behaviour of a complex system. However, if human expertise is not available we can still set up reasonable membership functions and start the learning process to generate a set up fuzzy if-then rules to approximate a desired data set.

The results show that the proposed system can identify the amounts of the additives for different classes of steel grade. Also the results show that the Multi-agent expert systems can be applied effectively in the steel-making.

6. References

- Bezdek, J.C. (1993). *Fuzzy mathematics in pattern classification*, Ph.D. dissertation. Cornell University, Ithaca, NY.
- Bezdek, J.C. and Pal, S.K. (1992). *Fuzzy Models for pattern Recognition*, IEEE press, New York.
- Council on Wage and Price Stability (1977). Report to the President on Prices and Costs in the United States Steel Industry. October. Washington, D.C.: U.S. Government Printing Office.
- Cowling, P. I., Ouelhadj, D., & Petrovic, S. (2004). Dynamic scheduling of steel casting and milling using multi-agents, *Production Planning and Control*, Vol. 15, page numbers 1-11.

- Cowling, P. I., Ouelhadj, D., & Petrovic, S. (2003). A Multi-agent architecture for dynamic scheduling of steel hot rolling, *Journal of Intelligent Manufacturing*, Vol. 14, page numbers 457-470.
- Fazel Zarandi, M.H., Ahmadpour, P. (2009). Fuzzy agent-based expert system for steel making process, *Expert Systems with Applications*, Vol. 36, page numbers 9539-9547.
- Fazel Zarandi, M.H., Avazbeigi, M., Turksen, I.B. (2009). A new Fuzzy Noise-rejection Data Partitioning Algorithm with Revised Mahalanobis Distance, *proceeding of IFSA09*.
- Huntsberger, T.L., Jacobs, C.L., and Cannon, R.L. (1993). Iterative fuzzy image segmentation, *Pattern Recognition*, Vol. 18, page numbers 131-138.
- Jang, J.S.R. (1991). Fuzzy modeling using generalized neural networks and kalman filter algorithm, *Proceedings of Ninth Nat. conf-Artificial Intell. (AAAI-91)*, pp. 762-767.
- Kim, Y.I., Moon, K.C., Kang, B.S., Han, C. and Chang, K.S. (1998). Application of neural network to the supervisory control of a reheating furnace in the steel industry, *Control Engineering Practice*, Vol. 6, page numbers 1009-1014.
- Lahdelma, R., & Rong, A. (2006). Scrap charge optimization using fuzzy chance constrained linear programming, *In New developments in artificial intelligence and the semantic web proceedings of the 12th Finnish artificial intelligence conference STeP*.
- Lee, C-C. (1990a). Fuzzy logic in control systems: Fuzzy logic controller-parti. *IEEE Trans. Syst. Man, cybern.*, Vol. 20, page numbers 404-418.
- Lee, C-C. (1990b). Fuzzy logic in control systems: Fuzzy logic controller-parti. *IEEE Trans. Syst. Man, cybern.*, Vol. 20, page numbers 419-435.
- Moghaddam Zadeh, A. and Bourbakis, N. (1997). A fuzzy region growing approach for segmentation of color images, *Pattern Recognition*, Vol. 30, page numbers 867-881.
- Nasraoui, O. Krishnapuram, R. (1996). An improved possibilistic C-Means algorithm with finite rejection and robust scale estimation, *proceeding of NAFIPS Biennial Conference of the North American*.
- Nguyen, H.H. and Cohen, P. (1993). Gibbs random field, fuzzy clustering and the unsupervised segmentation of textured images, *CVGIP Graphical Models Image Processing*, Vol. 55, page numbers 1-19.
- Ouelhadj, D., Petrovic, S., Cowling, P. I., & Meisels, A. (2004). Inter-agent cooperation and communication for agent-based robust dynamic scheduling in steel production, *Advanced Engineering Informatics*, Vol. 18, page numbers 161-172.
- Pal, S.K. and Ghosh, A. (1992). Image segmentation using fuzzy Correlation, *Inform. Sci.*, Vol. 62, page numbers 232-250.
- Pedrycz, W. (1996). Conditional Fuzzy C - Means, *Pattern Recognition Letters*, 17, page numbers 625 - 632.
- Perez De La Cruz, J.L., Marti, M.J., Conejo, R., Morales-Bueno, R. and Fernandez, T. (1994). An Expert System for Identifying Steels and Cast Irons, *Engng Applic. Artif. Intell.*, Vol. 7, No. 4, page numbers 455-459.
- Sugeno, M. (1985). *Ed. Industrial Applications of Fuzzy control*, New York Elsevier.
- Tsukamoto, Y. (1979). An approach to fuzzy reasoning method, In Madan M. Gupta, Rammohan K. Ragade and R. Yager eds. *Advances in fuzzy set theory and applications*, North-Holland, Amsterdam, page numbers 137-149.
- Takagi, T., Sugeno, M. (1985). Fuzzy identification of system and its applications to modeling and control. *IEEE Trans. Syst., Man, Cybern.*, Vol. 15, page numbers 116-132.

- Yang, M.-S., Su, C.F. (1994). On parameter estimation for normal mixtures based on fuzzy clustering algorithms, *Fuzzy sets and systems*, Vol. 68, page numbers 13-28.
- Krishnapuram, R., Keller, J.M. (1993). A Possibilistic Approach to Clustering, *IEEE TRANSACTIONS ON FUZZY SYSTEMS*, VOL. 1, No. 2 .

IntechOpen

IntechOpen



Expert Systems

Edited by Petrica Vizureanu

ISBN 978-953-307-032-2

Hard cover, 238 pages

Publisher InTech

Published online 01, January, 2010

Published in print edition January, 2010

Expert systems represent a branch of artificial intelligence aiming to take the experience of human specialists and transfer it to a computer system. The knowledge is stored in the computer, which by an execution system (inference engine) is reasoning and derives specific conclusions for the problem. The purpose of expert systems is to help and support user's reasoning but not by replacing human judgement. In fact, expert systems offer to the inexperienced user a solution when human experts are not available. This book has 18 chapters and explains that the expert systems are products of artificial intelligence, branch of computer science that seeks to develop intelligent programs. What is remarkable for expert systems is the applicability area and solving of different issues in many fields of architecture, archeology, commerce, trade, education, medicine to engineering systems, production of goods and control/diagnosis problems in many industrial branches.

How to reference

In order to correctly reference this scholarly work, feel free to copy and paste the following:

Mohammad Hossein Fazel Zarandi, Milad Avazbeigi, Mohammad Hassan Anssari and Behnam Ganji (2010). A Multi-Agent Expert System for Steel Grade Classification Using Adaptive Neuro-fuzzy Systems, Expert Systems, Petrica Vizureanu (Ed.), ISBN: 978-953-307-032-2, InTech, Available from:
<http://www.intechopen.com/books/expert-systems/a-multi-agent-expert-system-for-steel-grade-classification-using-adaptive-neuro-fuzzy-systems>

INTECH
open science | open minds

InTech Europe

University Campus STeP Ri
Slavka Krautzeka 83/A
51000 Rijeka, Croatia
Phone: +385 (51) 770 447
Fax: +385 (51) 686 166
www.intechopen.com

InTech China

Unit 405, Office Block, Hotel Equatorial Shanghai
No.65, Yan An Road (West), Shanghai, 200040, China
中国上海市延安西路65号上海国际贵都大饭店办公楼405单元
Phone: +86-21-62489820
Fax: +86-21-62489821

© 2010 The Author(s). Licensee IntechOpen. This chapter is distributed under the terms of the [Creative Commons Attribution-NonCommercial-ShareAlike-3.0 License](#), which permits use, distribution and reproduction for non-commercial purposes, provided the original is properly cited and derivative works building on this content are distributed under the same license.

IntechOpen

IntechOpen