

We are IntechOpen, the world's leading publisher of Open Access books Built by scientists, for scientists

5,600

Open access books available

138,000

International authors and editors

175M

Downloads

Our authors are among the

154

Countries delivered to

TOP 1%

most cited scientists

12.2%

Contributors from top 500 universities



WEB OF SCIENCE™

Selection of our books indexed in the Book Citation Index
in Web of Science™ Core Collection (BKCI)

Interested in publishing with us?
Contact book.department@intechopen.com

Numbers displayed above are based on latest data collected.
For more information visit www.intechopen.com



Designing Simple and Effective Expression of Robot's Primitive Minds to a Human

Seiji Yamada¹ and Takanori Komatsu²

¹National Institute of Informatics, ²Future University-Hakodate
Japan

1. Introduction

In recent years, home robots and entertainment robots like Roomba, AIBO have started to move out of laboratories and in people's homes. Almost all of them are for entertainment use to a user and the remaining ones are for a simple home task like rough sweeping by themselves. However home robots for a home task are expected to spread out in our daily life rapidly because there are strong needs for the robots to be able to achieve various home tasks like sweeping, cooking, washing up, clearance and so on. In this situation, since a robot often cannot achieve such a task by itself, it needs to ask a user help its task. For example, even though sweeping is a very simple home task, a robot can not remove a heavy or complicatedly structured obstacle like a chair, a table or a cart in order to sweep the floor under it. In this case, a robot should ask user helping behaviors to remove these obstacles.

The significant problem here is how to express the robot's internal state to a user. We call such an internal state the *robot's mind* because it may correspond to a human state of mind in the theory of mind (Baron-Cohen, 1995). We consider that these expressions should be designed depending on the robot's appearance because the appearance of the robots would significantly influence human impressions and interpretations of robot's expressions. Although it is an important problem to design how a robot expresses and informs its mind to a human depending on the appearance, few studies on designing robot's expression in such a way have been done thus far. In general, one of the simplest ways to express the mind is to use verbal communication with speech synthesis and it may be independent of a robot's appearance. However, in these days, such verbal communication significantly depends on the processing quality of natural language, and unfortunately, this quality is not mature for the actual use for our purpose. Hence we focused on nonverbal communication because various psychological researches showed that nonverbal communication also contains rich information than verbal ones.

In this chapter, we propose a policy to design expressions of robot's mind depending on its appearance, called "SE4PM: Simple Expression for Primitive Minds." According to this policy, we would like to argue that a designer should design simple information with a simple appearance to express primitive robot's minds (Yamada & Komatsu, 2006). We actually apply this SE4PM policy to express primitive minds of a robot with an appearance of a simple mobile robot implemented with LEGO MindStorms, and design beep sound as simple expression. We consider this beep sound is a promising way to express primitive

minds like negative, positive, and neutral because it was reported to be effective in human-computer interaction (Komatsu, 2006). To compare with our proposed expression, we utilized a pet robot, AIBO, which has a complicated appearance and can express its primitive minds by executing some complex behaviors with motion, light and sound. We investigate the effectiveness of SE4PM policy by a psychological experiment to compare the two robots. Finally we obtain results to support our SE4PM policy and find out it is a valid policy to design expression of robot's primitive minds depending on the appearance.

Different types of social robots have been developed to assist with various tasks in our daily life (Morishima et al, 1995; Ishiguro et al, 2001). In general, these robots have a particular appearance that is designed similar to that of humans or pet animals, i.e., beings that are familiar to us. Most humans who interact with these robots notice the familiarity of their appearances, and this makes it easier for them to communicate with these robots actively (Breazeal & Velasquez, 1998). However, a robot's appearance should not be the sole focus; designing the robot's expressed minds to enable better communication with users is also important. Based on this concept, Ono and Imai (Ono & Imai, 2000) developed an interactive robot that can express behaviors associated with frustration when it encounters certain obstacles that interrupt its pathway.

On the relationship between a robot's appearance and the function, Mori pioneered relationship between an appearance and a movement in a robot with the uncanny valley (Mori, 1970; 1982). His uncanny valley described a robot becomes more uncanny as it becomes more similar to a real human. Although the uncanny valley does not directly imply SE4PM, the basic consideration is close to it. We will discuss the relationship of the uncanny valley and our SE4PM with feasibility, familiarity and implementability in terms of engineering. Duffy also discussed anthropomorphism of a robot with much insight (Duffy, 2003), and he pointed out various important issues on relationship between anthropomorphism and a robot. In contrast with their studies, we propose the concrete design policy to express primitive minds, actually design them and verify the effectiveness. Matsumoto et al. proposed a "Minimal Design" for interactive agents (Matsumoto et al, 2005); that is, agents should only have a minimalist appearance or express a minimal amount of information to users. In fact, they applied this minimal design policy in developing their interactive robots "Muu" (Okada et al, 2000) and life-like agent "Talking Eye" (Suzuki et al, 2000). Moreover, Reeves & Nass showed in their "Media Equation" studies that anthropomorphized agents or computers might induce natural behaviors in humans, such as those that we direct towards other people (Reeves & Nass, 1996). Although the policies of minimal design and Media Equation are similar to our hypothesis that a detailed and likable appearance and expressed information are not vital for informing us of primitive minds, they lack a concrete strategy, like "which kinds of appearance should agents have" or "which kinds of information should agents express to users." In contrast, our study provides a concrete strategy for designing interactive agents by clarifying the relationship between the agent's appearance and its expressed information to make user understands these primitive minds.

Kanda et. al (Kanda et al, 2005) investigated human behaviors to humanoid robots with two different appearances, ASIMO, Robovie (Ishiguro et al, 2001), through a systematic psychological experiment with participant. As results, they found statistical significant difference in non-verbal behaviors like movement of arms, greeting motions, not in verbal

behaviors. Their results are interesting, however they do not propose any design policy to express robot's minds.

2. SE4PM: Design Policy to Express Robot's Primitive Minds to a Human

We propose a policy to design expression of robot's minds depending on the appearance, called "SE4PM: Simple Expression for Primitive Mind". According to this SE4PM, we would like to argue that a designer should design simple information from a robot with a simple (e.g. robot-like) appearance to express its primitive minds. On the other hand, this policy is based on the following hypothesis about the relationship between the robot's appearance and its expressed information on the user's understanding of primitive minds: A robot with a human-like or animal-like appearance expressing complex and likable actions or behaviors is more confusing for users and is not really effective for conveying primitive minds. On the other hand, an robot with a more typical robot appearance conveying subtle expression (Liu & Picard, 2003), which shows simple but intuitive information that can be more readily understood, is much more effective for informing users of the robot's primitive minds (Fig. 1). If this hypothesis to support SE4PM was shown to be true, various interactive robots could be developed, ones that can interact naturally with users without the need for a huge budget to create a complex and likable appearance for these robots.

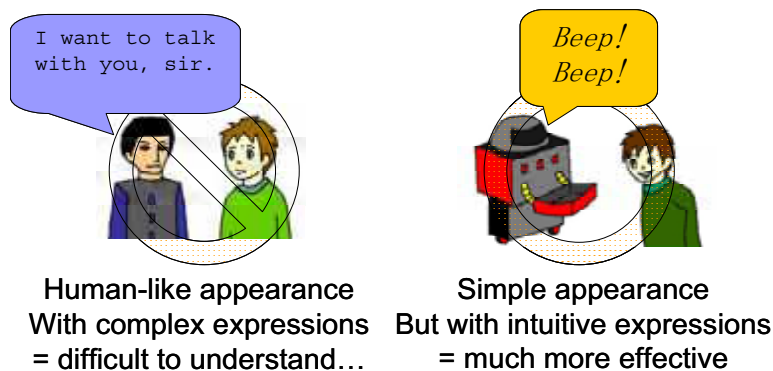

Figure 1. Concept of our hypothesis about the relationship between robot's expressed information and its appearance

3. Realizing SE4PM with Beep Sounds and Mobile Robot-Like Appearance

According to SE4PM, it is expected that we are able to design actual expression and appearance of a robot for express primitive minds. In this study, we realize simple expression with beep sounds and simple appearance with a mobile robot-like appearance. This realization is based on the following reasons.

Beep sounds: Komatsu (Komatsu, 2006) showed that people can estimate different primitive minds by means of simple beep-like sounds with different durations and inflections. He reported the following results.

- Sounds with decreasing intonation with shorter durations were perceived as a "positive mind," such as "agreement."

- Sounds with increasing intonation regardless of its durations were perceived as a “negative mind,” such as “disagreement.”
- Flat sounds with longer durations were estimated as a “neutral mind,” such as “hesitation.”

These beep sounds were simple but intuitive and effective information for the user to understand primitive minds. We applied these beep sounds as expressed information from robots that did not have a life-like appearance and behaviors.

Mobile robot-like appearance: We formed the MindStorms as a mobile robot, thus Mobile robot-like appearance is utilized without cost of additional sensors and actuators. As well known, MindStorms is a kind of LEGO, thus we can easily configure the appearance with various simple sensors and actuators.

4. Experiments

4.1 Overview

As already mentioned, our SE4PM hypothesized that a robot with a typical robot appearance expressing simple but intuitive information regarding primitive minds is much more effectively to users. We then conducted a psychological experiment to investigate this hypothesis.

4.1.1 Expressing Minds

We focused on the following three primitive minds as primitive and important ones for a user: negative, positive, and neutral. These three minds correspond to a valence value that is the basic dimension of complex emotions or affect (Reeves & Nass, 1996). These minds were briefly explained to the participants so that they would have a rough idea of how to recognize the minds.

- Positive Mind: Agreement, e.g., acceptance.
- Negative Mind: Disagreement, e.g., surprising, doubting.
- Neutral Mind: Hesitation, e.g., being lost for words.
- These three primitive minds and interpretations were the same as the ones used in Komatsu’s former study (Komatsu, 2006).

4.1.2 Appearance of Robots

We utilized the following two robots as robots in our experiment. One was AIBO (ESR-7, SONY corporation). It is a robot that has a detailed and animal-like appearance and behaviors. The other was MindStorms (Robotic Invention System 2.0, LEGO cooperation) which is the robot that has a typical robotic appearance like “Star Wars’ R2D2.” AIBO is one of the most famous consumer pet robots, and MindStorms consists of LEGO blocks and Micro-computer modules. The user can then determine their preferred robot appearance by using various types of LEGO blocks. The appearances of AIBO and MindStorms are shown in Fig. 2.

In addition, for a control condition, we utilized a normal laptop PC (Let’s Note, W2 CF-W2DW6AXR, Panasonic corporation) that was utilized to express beep sounds in the former study (Komatsu, 2006). The reason we utilized this laptop PC as a control was that it has a non-robot-like appearance compared with other robots (AIBO and MindStorms). In this

research, remind that we call this PC a robot too. Fig. 3 shows the actual appearance of these three robots. They actually have the nearly same body size.



Figure 2. The appearances of AIBO (left) and MindStorms (right)



Figure 3. Two robots and a PC utilized in this experiment: AIBO, MindStorms, and a laptop PC (from left to right)

4.1.3 Expressed Information

For expressing primitive minds to users, AIBO expresses the prepared dog-like behaviors, and MindStorms and the PC express the beep sounds that were utilized in Komatsu's former study (Komatsu, 2006).

- *Expressing information of AIBO* : SONY prepared utility software called the "AIBO entertainment player" for AIBO users, which offers about 80 basic preset motions, like "cheer up" and "good morning." Among these motions, we chose the following six motions (two motions for each mind) that were similar to typical dog-like behaviors and accorded them with three primitive minds.
 - Positive mind: "Happy 1" (wagging her tail cheer-fully), "Happy 3" (blinking face LED expresses smiling face)
 - Negative mind: "Angry 1" (howling action), "Un-happy 1" (moving her tail cheerlessly)
 - Neutral mind: "Incline her head", "Wondering" (looking doubtful while moving her tail)
- *Expressing information of MindStorms and PC* : The following six beep sounds (two sounds for each mind) showed higher interpretation rates (more than 80%) in the former study in each of the minds. These sounds were triangle waves generated by sound authoring software called "Cool Edit 2000," and they have the same F0 average of 131Hz.
 - Positive mind: Two beep sounds with decreasing intonation (One is a duration of 189ms and a de-creasing transition range in the F0 value between the onset and endpoint of 125Hz; the other is a duration of 418ms and a decreasing transition range of 125Hz)
 - Negative mind: Two beep sounds with increasing intonation (One is a duration of 189ms and an increasing transition range of 125Hz; the other is a duration of 819ms and an increasing transition range of 125Hz)
 - Neutral mind: Two beep sounds with a flat intonation (One is a duration of 639ms; the other is a duration of 819ms)

Just before AIBO expressed these behaviors to participants, the experimenter said "Ready" to them, and then AIBO started expressing the selected behaviors. Before MindStorms expressed these sounds, the experimenter started moving MindStorms backward by about 5 cm and then forward by about the same distance. And before the PC expressed its sounds, the experimenter flashed its display. These actions were meant to tell the participants that the "stimulus is about to be expressed."

4.2 Experimental Procedure

The participants were 18 Japanese university students (12 men and 6 women with a mean age of 21.2 years). All participants were not familiar with AIBO, MindStorms, and other robots in general.

First, the experimenter gave participants the following instructions: "the purpose of this experiment is to evaluate the three robots by means of a questionnaire. Specifically, these robots express certain information that includes one of three primitive minds (positive, negative, and neutral), and your tasks in this experiment are to answer "which kinds of mind were included with the expressed information," and to tell us your impression of these robots in the questionnaire."

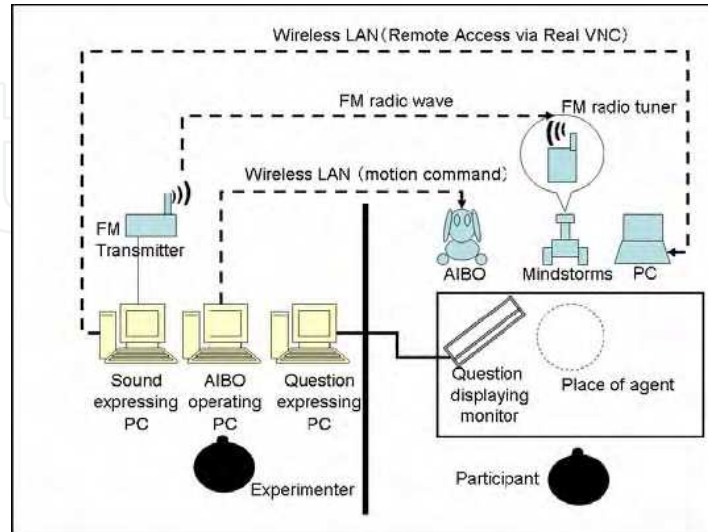

Figure 4. Experimental settings



Figure 5. Actual experimental scene (a participant facing AIBO)

The experimenter locating behind the partition used a wireless LAN to make AIBO express its behaviours in front of participants. To make MindStorms express its beep sounds, the experimenter played the sounds on a computer beside him, and then the sounds were transmitted as an FM radio wave. The FM radio tuner loaded on MindStorms received this radio wave and played the received sounds to participants. For the PC, the experimenter remotely controlled it by means of "Real VNC remote access system," and he started

playing the beep sounds at the appropriate time. The set up of the experiment is depicted in Fig. 4, and a photograph of the actual conditions in the experiment is Fig. 5, where a participant is facing with AIBO.

When the robots expressed the behaviors or sounds to participants, the display placed in front of them simultaneously showed the following questions, “*Did you feel that M was this robot’s mind based on this presented information?*”; *M* was the randomly selected mind among the three primitive minds. Participants were asked to answer YES or NO on the questionnaire. Specifically, each participant went through 18 trials (6 parts of information X 3 minds) for each robot. The order of presentation for the stimulus-question pairs was counterbalanced, and all participants were assumed to have contingent tendencies for judging each of the trials.

After finishing 18 trials with one robot, the participants were asked to fill in a questionnaire about their impressions of these robots. The questions are shown in Table 1. After filling in this questionnaire, another 18 trials were conducted with the next robot, and then again with the last one. Thus, all participants worked with all three robots. The experiencing ordering of robots (AIBO, MindStorms and PC) was also counterbalanced.

- | |
|--|
| <p>Q1: Did you understand the robot’s minds?</p> <p>Q2: Was the expressed information easily understandable?</p> <p>Q3: Did you enjoy the way that the robot expressed its information?</p> <p>Q4: Do you think that this robot can be part of our daily life?</p> <p>Q5: Do you think that this robot has emotions?</p> <p>Q6: Do you think that you can communicate effectively with this robot?</p> |
|--|

Table 1. Questionnaires on impressions of a robot

5. Experimental Results

5.1 Can Participants Estimate the Robot’s Mind Correctly?

The average number of correct answers (within 18 trials) was calculated for each robot to determine whether or not the participants could estimate the robot’s minds correctly. The results were that participants showed an average of 8.50 answers correct with AIBO, 14.33 with MindStorms, and 13.78 answers with the PC as shown in Fig. 6.

From these results, it is evident that using MindStorms or a PC is a much more effective method of informing participants of a robot’s minds compared with AIBO. Thus, these results support our hypothesis of SE4PM, which is, a robot with a typical robot appearance expressing simple but intuitive information regarding primitive minds is much more effectively to users than a robot that has a life-like appearance expressing more complex and likable behaviors. Although some concerns remain as to whether our hypothesis of SE4PM will stand up to further scientific analysis in an experiment, these results to support SE4PM

will likely have a significant impact on the traditional design policy, which has attempted to make the robot's appearance similar to those of humans or pets.

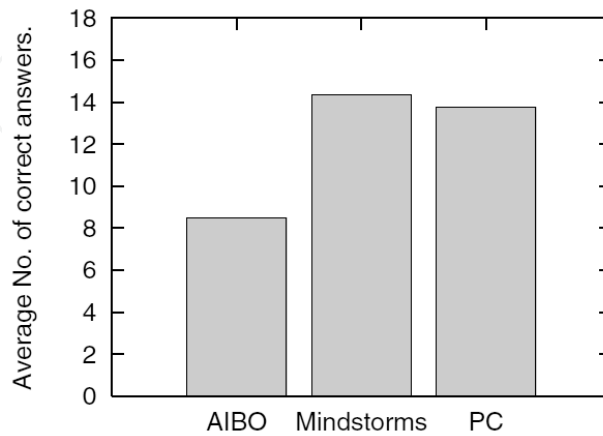

Figure 6. Average numbers of correct answers for each robot

5.2 Subjective Impressions of These Robots

We investigated the user's subjective impressions about these three robots by means of a questionnaire that was completed for each of the robots after the trials. Our investigation involved the use of an ANOVA of each of the aforementioned questions, which were answered using a six point likert scale (With lower points indicating poorer assessment: one point was the worst assessment, and six points was the best).

The average scores in evaluating the different robots for each question are depicted in Fig. 7. AIBO had the highest evaluations, and the PC had the lowest. However, the results of the ANOVA determined that four different relationships were present between the three robots.

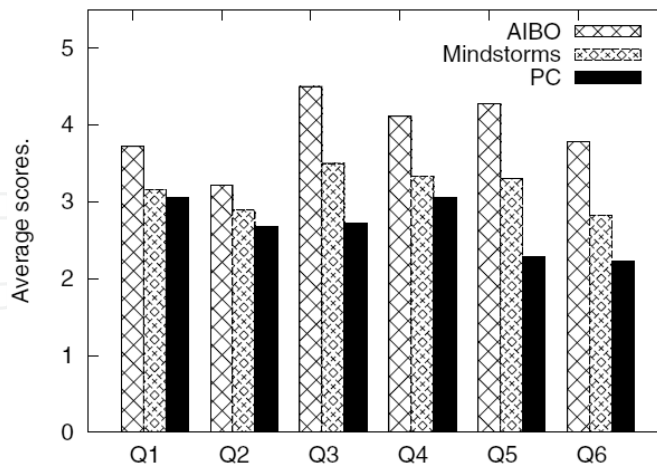

Figure 7. Average scores for each question in questionnaire

- *Relationship A:* AIBO received the highest overall evaluation: This relationship was observed in Q3 “Did you enjoy the way that the robot expressed its information?” and Q4 “Do you think that this robot can be part of our daily life?” Specifically, there were significant differences between AIBO and MindStorms and between AIBO and the PC (Q3: $F(2,51) = 10.33, p < .01 (**), Mse = 1.3845, 5\% \text{ level}$, Q4: $F(2,51) = 4.38, p < .05 (*), Mse = 1.2298, 5\% \text{ level}$). These results stem from the fact that AIBO is already well known as a sophisticated robot for entertainment purposes.
- *Relationship B:* AIBO received a higher evaluation compared with the PC: This relationship was observed in Q1 “Did you understand the robot’s minds?” The only significant tendency was between AIBO and the PC ($F(2,51) = 3.16, p < .10 (+), Mse = 0.7265, 5\% \text{ level}$). However, the average number of correct answers for the PC’s responses was significantly higher than that for AIBO, and it was nearly the same as that of MindStorms. Thus, a significant gap was evident between the effectiveness of the actual function (informing participants of the robot’s minds) and the participants’ impressions of the robots.
- *Relationship C:* Order of preference in the evaluation was AIBO, MindStorms, and PC: This relationship was observed in Q5 “Do you think that this robot has emotions?” and Q6 “Do you think that you can communicate with this robot?” Specifically, significant differences were evident between these three robots (Q5: $F(2,51) = 23.64, p < .01 (**), Mse = 0.7614, 5\% \text{ level}$, Q6: $F(2,51) = 14.56, p < .01 (**), Mse = 0.7492, 5\% \text{ level}$). Here, AIBO received the highest evaluation, just as in relationship A. Moreover, MindStorms received a higher evaluation than the PC.
- *Relationship D:* No differences among the two robots and the PC: This relationship was observed in Q2 “Was the expressed information easily understandable?” ($F(2,51) = 1.04, n.s.$). Here, although AIBO received higher evaluations on most questions, there were no significant differences between the three robots.

6. Discussion

6.1 Coverage of SE4PM

We conducted psychological experiment to verify the effectiveness of SE4PM design policy, and it can be said that the results eventually supported our proposed SE4PM. However these results are concerned with just case studies and just one example of various SE4PM realizations. Hence we need to discuss the coverage of the experimental results.

We consider the generality as to the following. First the results in this work show a concrete example that SE4PM-based robot design outperformed conventional one, with life-like and complicated appearance and expression, in expressing primitive minds. This also shows that another direction to design effective social robot without expensive appearance and actuators.

Second, by developing various simple expression based on SE4PM under a fixed robot-like appearance, the coverage of SE4PM can spread more and more. For example, we also developed and investigated a motion-based method to inform a user of robot’s minds (e.g. a trouble with the front obstacle) (Kobayashi & Yamada, 2005). In this work, a simple back-and-forth behavior of a robot with a simple mobile robot’s appearance is shown effective. We can utilize this behavior as simple expression and extend simple expression of SE4PM.

6.2 What Will the Gap between User's Impressions and Mind Estimation Cause?

The results of the experiment clarified that the evaluations of AIBO in the questionnaires were mostly higher than those of the other robots. However the average number of correct answers in interpreting AIBO's basic behaviors was significantly lower. At a glance, the first set of results indicates that AIBO is an appropriate robot for communicating with users. However, these superiorities are derived from its well-designed appearance as a commercial product or from participants' superficial impressions, such as "AIBO is a famous, cute, and clever pet robot," not from the fact that its behaviors are easily understandable. Yet, a serious gap has been demonstrated between the high evaluation participants gave AIBO and its inability to inform participants of its primitive minds. Specifically, the results of Q1 in table 1 are an obvious piece of evidence for this gap; AIBO received its highest evaluation on Q1 "Did you understand the robot's minds?" even though most participants perceived AIBO's expressed information incorrectly.

If these participants continued interacting with this robot, they would eventually notice the gap between its behavior and appearance, and then this gap might disappoint the participants and cause them to lose interest in communicating with it further. They would say something to the effect that "This robot looks very cute, but its behaviors are not really understandable..." This indication can be observed in the results of Q2 "Was the expressed information easily understandable?" No significant difference existed between the three robots on this question.

MindStorms, the other robot used in our test, received a lower evaluation from participants. However, the average number of correct answers was significantly higher; that is, MindStorms was better at informing participants of their primitive minds. If participants continuously communicated with it, they might notice that its behavior was more understandable, and subsequently, they might have a better subjective impression of the robot.

6.3 Influence of Robot's Appearance on Users

In our experiment, MindStorms and the PC expressed the same information (beep sounds) so that we could investigate the effects of the robots' appearance on the user's impressions and on their ability to estimate the robot's primitive minds.

In regards to estimating primitive minds, the average number of correct answers to MindStorms' expression was somewhat higher than that to PC's ones. However, the differences were not significant. The participants' impressions of MindStorms were significantly higher on the following two questions related to the participants' emotions: Q5 "Do you think that this robot has emotions?" and Q6 "Do you think that you can communicate with this robot?" These results were caused by the familiarity with the MindStorms' robot-like appearance, compared with the PC, which did not have a robot-like appearance. However, this does not automatically mean that pursuing a familiar appearance increased the evaluations of participants.

6.4 Relationship with Mori's Uncanny Valley

6.4.1 Life-Likeness and Familiarity

So far we discussed about the relationship between the robot's appearance and its expressed information for informing its minds for humans. On the other hand, about the effects of the robots' appearance (or human likeness) on the familiarities human users would feel, Mori

(Mori, 1970; 1982) proposed the pioneering hypothesis *uncanny valley*; that is, the appearance of the robot is getting similar to ones of human beings, in some point, humans suddenly start feeling uncanny or losing the familiarities with this robot because the subtle differences on the appearances between actual human beings and the robots are emphasized. Mori described this relationship between the robots' *life-likeness* to human beings and *familiarity* that human users would feel as the following qualitative diagram shown in Fig. 8.

Basically, we agree with this Mori's hypothesis because the relationship between the robots' appearance and the familiarities seems to succeed in explaining our hypothesis shown in Fig. 1: the robots with rich appearance (quite similar with actual humans or pet animals) expressing the likely information (verbal information or animal like behaviors) are more confusing to users and are not really effective for interacting with users: Instead, the robots without rich appearance expressing the simple but intuitive information such as subtle expressions are readily understood and are much more effective for their interaction.

We assumed that the former case in the above our hypothesis (the robots with rich appearance expressing the likely information) would correspond to the *bottom* (*B* in Fig. 8) of the uncanny valley, so that it is expected that users would feel uncomfortable as shown in the left of Fig. 1. On the other hand, we also assumed that the latter case (the robot without rich appearances expressing subtle expressions) would correspond to the *peak* (*P* in Fig. 8) just before starting the uncanny valley, so that it is expected that users would feel comfortable as shown in the right of the Fig. 1 (Komatsu & Yamada, 2007).

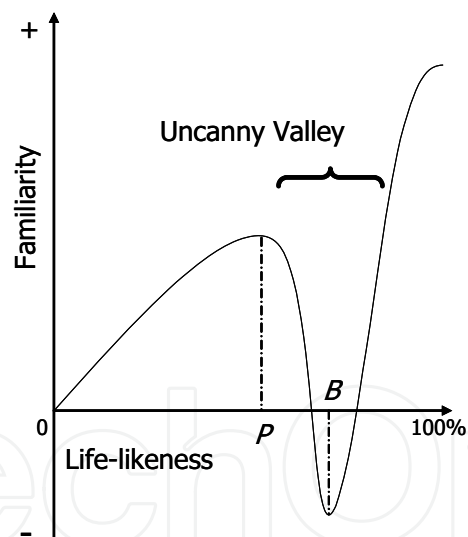

Figure 8. The concept diagram of Uncanny Valley (Mori, 1970)

6.4.2 Life-likeness and Implementability

In this chapter, we assumed that the robot without rich appearance expressing the simple but intuitive information, e.g., subtle expression, is much more effective for human users to understand the robots' minds. One of the reasons to focus on utilizing subtle expressions is

that it is technically and economically easy to implement these kinds of expressions into the robot. However, this does not imply that every kind of the robots should express the subtle expressions.

Corresponding to the results of this study, these subtle expressions should be designed according to the appearance of the robots, e.g., the beep sounds should be expressed from PC, not from robots. Therefore, each robot would have each appropriate subtle expression, and then its *implementability* would be getting decreasing according with increasing the *life-likeness* shown in Fig. 9. Simply saying, the robot without rich appearance (lower life-likeness) requires expressing rather simple expressions, while the robot with rich experience (higher life-likeness) does complex expressions. We assumed that the implementability is constantly decreasing according to increment of the life-likeness.

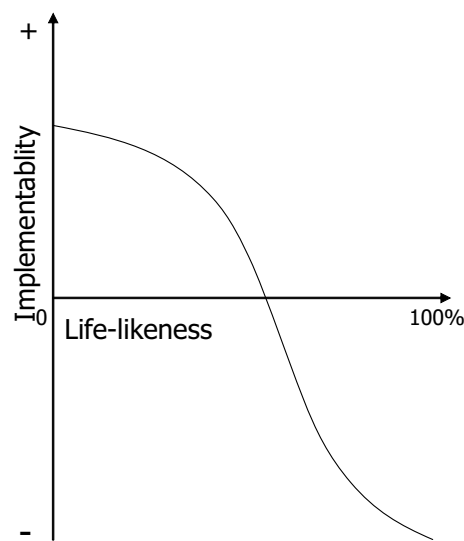

Figure9. The hypothesized implementability according to its life-likeness

6.4.2 Familiarity, Implementability and Life-likeness

So far we discussed about the relationship between the life-likeness of the robots and the familiarity human users would feel, and the one between the life-likeness and the implementability of expressed information. It can be said that the former relationship *familiarity* is about between the robot and the user, while the later one *implementability* is about between the robot and the designer. Thus we are able to describe them as the following two equations.

$$\text{Familiarity} = q(\text{robot, user}) \quad (1)$$

$$\text{Implementability} = w(\text{robot, designer}) \quad (2)$$

Here, we assumed that the factor *feasibility* of the intimate interaction between users and the robots can be proposed by the sum of the two factors *familiarity* and *implementability* as the following equation (3) and (4):

$$\text{Feasibility} = \text{Familiarity} + \text{Implementability} \quad (3)$$

$$= q(\text{robot, user}) + w(\text{robot, designer}) \quad (4)$$

From the equation (4), this feasibility could include the three factors, “user,” “robot” and “designer” that are the important factors to form the interaction design. Therefore, we expect that this feasibility factor could literally indicate whether the user and the robot could create the intimate interaction or not.

We hypothesized that it is possible to superpose the familiarity and the implementability according to the life-likeness. We could then acquire the concept diagram of the *feasibility* shown in Fig. 10, by the sum of the graphs in Fig. 8 and Fig. 9. From this figure, at first its feasibility values are getting increase around *life-likeness* = P , however, this value suddenly decreases, as if the familiarity value falls into the uncanny valley. In addition, even though the life-likeness value is getting close to 100% life-likeness, the feasibility values could not recover to the same level of life-likeness P .

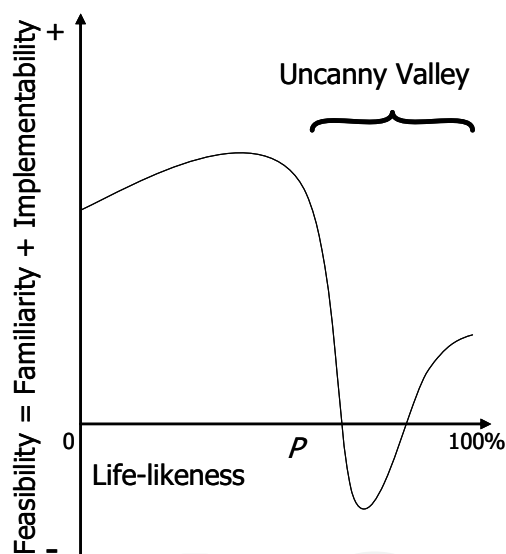

Figure 10. The hypothesized feasibility according to its life-likeness

Thus, it can be said that this figure shows that the robot with higher life-likeness would have the lower feasibilities to create an intimate relationship between the users and the robots, while the robot with lower life-likeness would have the higher feasibilities. This feasibility concept would support our hypothesis shown in Fig. 1, and accord the basic concept of the Mori's uncanny valley hypothesis.

However, there is one significant difference Mori's hypothesis: that is, once the feasibility value falls into the uncanny valley, this value never rises up to the peak of feasibility at life-likeness = P even though its life-likeness value is getting close to 100% life-likeness. We assumed that this phenomenon about the feasibility diagram would support again our hypothesis shown in Fig. 1.

As the consecutive studies based on the results of this study and our feasibility concept, we are planning to conduct the other experiments to reveal what is the most appropriate information according to the robots' appearance. For example, what is the appropriate information expressing from Mindstorms robot to inform its primitive attitudes? Are Starwars' R2D2 like behaviors appropriate? We expect that these consecutive studies would support our feasibility concept that can clarify the effective coupling between the appearance and its expressing information for realizing interactive robots readily and easily.

7. Conclusion

Various kinds of social robots have been developed to assist us with different tasks in our daily life. One of the most important issues in these studies is how to express the robot's primitive minds to a user for communication between them. This issue is strongly related to the robots' expressed information and its appearance. However few studies have investigated the relationship between these. Most studies applied human-like or animal-like appearance in the robots.

In this chapter, we proposed design policy of robot's expression of its primitive minds, SE4PM: Simple Expression for Primitive Mind, that means that a designer should design simple information with a simple appearance to express robot's primitive minds. To realize expression based on SE4PM, we designed mobile robot-like robot, MindStorms, with simple beep sound. We conducted a psychological experiment to clarify effectiveness of SE4PM by using AIBO entertainment robots with likely behaviors and MindStorms with beep sounds as simple expression. The results of our experiment supported SE4PM. Based on these results, we are able to create a design policy for simple and effective robots to interact with users. Eventually we discussed various properties of SE4PM and the relationship between feasibility (familiarity, implementability) and life-likeness based on Mori's uncanny valley.

8. Acknowledgements

This research has been supported by Grant-in-Aid for Exploratory Research (No. 18650034) from The Ministry of Education, Culture, Sports, Science and Technology, Japan and also NII Collaboration Grants (No. E-4) from National Institute of Informatics, Japan.

9. References

- Baron-Cohen, S. (1995). *Mindblindness*, MIT Press, Cambridge, MA, USA.
- Breazeal, C. & Velasquez, J. (1998). Toward teaching a robot 'infant' using emotive communication acts. In *Proceedings of 1998 Simulation of Adaptive Behavior, Workshop on Socially Situated Intelligence*, pp. 25-40, Zurich, August.
- Duffy, B. R. (2003) Anthropomorphism and the social robot. *Robotics and Autonomous Systems*, 42, 177-190
- Ishiguro, H.; Ono, T.; Imai, M., Maeda, Kanda, T. & Nakatsu, R. (2001) Robovie: an interactive humanoid robot. *International Journal of Industrial Robot*, 28, 6, 498-503
- Kanda, T.; Miyashita, T.; Osada, T.; Haikawa, Y. & Ishiguro, H. (2005) Analysis of humanoid appearances in human-robot interaction. In *Proceedings of 2005 IEEE/RSJ International Conference on Intelligent Robots and Systems*, pp. 62-69, Edmonton, August.

- Kobayashi, K. & Yamada, S. (2005) Informing a user of robot's mind by motion. In *Proceedings of Third International Conference on Computational Intelligence, Robotics and Autonomous Systems, SS4B-3*, Singapore, December.
- Komatsu, T. (2006) Audio subtle expressions affecting user's perceptions. In *Proceedings of 2006 International Conference on Intelligent User Interface*, pp. 306-308, San Diego, January.
- Komatsu, T. & Yamada, S. (2007): Effects of robotic agents' appearances on users' interpretations of the agents' attitudes: towards an expansion of uncanny valley assumption, In *Proceedings of the 16th International Workshop on Robot and Human Interactive Communication*, to appear, Jeju Island, September.
- Liu, K. & Picard, W. R. (2003) Subtle expressivity in a robotic computer. In *Proceedings of the CHI-2003 Workshop on Subtle Expressivity for Characters and Robots*, pp. 5-9, Florida, April.
- Matsumoto, N.; Fujii, H.; Goan, M. & Okada, M. (2005) Minimal design strategy for embodied communication agents. In *The 14th IEEE International Workshop on Robot-Human Interaction*, pp. 335-340, Nashville, August.
- Mori, M. (1970): Bukimi no tani (The Uncanny Valley). *Energy*, 7, 4, 33-35. (Originally in Japanese)
- Mori, M. (1982) *Buddha in the Robot*. Carles E. Tuttle Co.
- Morishima, S.; Iwasawa, S.; Sakaguchi, T.; Kawakami, F. & Ando, M. (1995). Better face communication. In *Visual Proceedings of SIGGRAPH'95 Interactive Communities*, page 117.
- Okada, M.; Sakamoto, S. & Suzuki, N. (2000) Muu: Artificial creatures as an embodied interface. In *Proceedings of 27th International Conference on Computer Graphics and Interactive Techniques (SIGGRAPH 2000)*, page 91, New Orleans, July.
- Ono, T. & Imai, M. (2000) Reading a robot's mind: A model of utterance understanding based on the theory of mind mechanism. In *Proceedings of the Seventeenth National Conference on Artificial Intelligence*, pp. 142-148, Austin, July.
- Reeves, C. B. & Nass, C. (1996). *The Media Equation: How people treat computers, television, and new media like real people and places*. Cambridge, UK: Cambridge Press.
- Suzuki, N.; Takeuchi, Y.; Ishii, K. & Okada, M. (2000) Talking eye: Autonomous creatures for augmented chatting, *Robotics and Autonomous Systems*, 31, 171-184, Elsevier.
- Yamada, S. & Komatsu, T. (2006): Designing simple and effective expression of robot's primitive minds to a human, In *Proceedings of the 2006 IEEE/RSJ International Conference on Intelligent Robots and Systems*, pp.2614-2619, Beijing, October.



Human Robot Interaction

Edited by Nilanjan Sarkar

ISBN 978-3-902613-13-4

Hard cover, 522 pages

Publisher I-Tech Education and Publishing

Published online 01, September, 2007

Published in print edition September, 2007

Human-robot interaction research is diverse and covers a wide range of topics. All aspects of human factors and robotics are within the purview of HRI research so far as they provide insight into how to improve our understanding in developing effective tools, protocols, and systems to enhance HRI. For example, a significant research effort is being devoted to designing human-robot interface that makes it easier for the people to interact with robots. HRI is an extremely active research field where new and important work is being published at a fast pace. It is neither possible nor is it our intention to cover every important work in this important research field in one volume. However, we believe that HRI as a research field has matured enough to merit a compilation of the outstanding work in the field in the form of a book. This book, which presents outstanding work from the leading HRI researchers covering a wide spectrum of topics, is an effort to capture and present some of the important contributions in HRI in one volume. We hope that this book will benefit both experts and novice and provide a thorough understanding of the exciting field of HRI.

How to reference

In order to correctly reference this scholarly work, feel free to copy and paste the following:

Seiji Yamada and Takanori Komatsu (2007). Designing Simple and Effective Expression of Robot's Primitive Minds to a Human, Human Robot Interaction, Nilanjan Sarkar (Ed.), ISBN: 978-3-902613-13-4, InTech, Available from:

http://www.intechopen.com/books/human_robot_interaction/designing_simple_and_effective_expression_of_robot_s_primitive_minds_to_a_human

INTECH
open science | open minds

InTech Europe

University Campus STeP Ri
Slavka Krautzeka 83/A
51000 Rijeka, Croatia
Phone: +385 (51) 770 447
Fax: +385 (51) 686 166
www.intechopen.com

InTech China

Unit 405, Office Block, Hotel Equatorial Shanghai
No.65, Yan An Road (West), Shanghai, 200040, China
中国上海市延安西路65号上海国际贵都大饭店办公楼405单元
Phone: +86-21-62489820
Fax: +86-21-62489821

© 2007 The Author(s). Licensee IntechOpen. This chapter is distributed under the terms of the [Creative Commons Attribution-NonCommercial-ShareAlike-3.0 License](https://creativecommons.org/licenses/by-nc-sa/3.0/), which permits use, distribution and reproduction for non-commercial purposes, provided the original is properly cited and derivative works building on this content are distributed under the same license.

IntechOpen

IntechOpen