

We are IntechOpen, the world's leading publisher of Open Access books Built by scientists, for scientists

5,300

Open access books available

129,000

International authors and editors

155M

Downloads

Our authors are among the

154

Countries delivered to

TOP 1%

most cited scientists

12.2%

Contributors from top 500 universities



WEB OF SCIENCE™

Selection of our books indexed in the Book Citation Index
in Web of Science™ Core Collection (BKCI)

Interested in publishing with us?
Contact book.department@intechopen.com

Numbers displayed above are based on latest data collected.
For more information visit www.intechopen.com



An Adaptive Controller Design for Flexible-joint Electrically-driven Robots With Consideration of Time-Varying Uncertainties

Ming-Chih Chien¹ and An-Chyau Huang²

¹*Mechanical and Systems Research Laboratories, Industrial Technology Research Institute,*

²*Dept. of Mechanical Engineering, National Taiwan University of Science and Technology
Taiwan, R.O.C.*

1. Abstract

Almost all present control strategies for electrically-driven robots are under the rigid robot assumption. Few results can be found for the control of electrically driven robots with joint flexibility. This is because the presence of the joint flexibility greatly increases the complexity of the system dynamics. What is worse is when some system dynamics are not available and a good performance controller is required. In this paper, an adaptive design is proposed to this challenging problem. A backstepping-like procedure incorporating the model reference adaptive control is employed to circumvent the difficulty introduced by its cascade structure and various uncertainties. A Lyapunov-like analysis is used to justify the closed-loop stability and boundedness of internal signals. Moreover, the upper bounds of tracking errors in the transient state are also derived. Computer simulation results are presented to demonstrate the usefulness of the proposed scheme.

Keywords: Adaptive control; Flexible-joint electrically-driven robot; FAT

2. Introduction

Control of rigid robots has been well understood in recent years, but most of the schemes ignore the dynamics coming from electric motors and harmonic drivers that are widely implemented in the industrial robots. However, actuator dynamics constitute an important part of the complete robot dynamics, especially in the cases of high-velocity movement and highly varying loads[1],[2]. The main reason for using a reduced model is to simplify complexity of controller design. For each joint, consideration of the flexibility from the

¹ M. C. Chien was with the Department of Mechanical Engineering, National Taiwan University of Science and Technology. He is now with the Mechanical and Systems Research Laboratories, Industrial Technology Research Institute, No. 195, Sec. 4, Chung-Hsing Rd., Chutung, Hsinchu, 310, Taiwan, R.O.C. (e-mail: D9203401@mail.ntust.edu.tw).

² A. C. Huang is with the Department of Mechanical Engineering, National Taiwan University of Science and Technology. No. 43, Keelung Rd., Sec. 4, Taipei, Taiwan, ROC. (Tel:+886-2-27376490, Fax: +886-2-37376460, E-mail: achuang@mail.ntust.edu.tw). (A. C. Huang provides phone number because he is the corresponding author.)

harmonic driver results in an additional 2nd order dynamics. If the motor dynamics is also included, a totally 5th order dynamics should be considered. It is well-known that a multi-DOF rigid robot is a highly nonlinear and coupled system. If we consider the motor dynamics and joint flexibility for all joints, the controller design problem would become extremely difficult. In this paper, we would like to design a controller for a flexible-joint electrically-driven robot under more challenging conditions, that is, the robot system contains various uncertainties.

Better motion control performance was obtained by Tarn et. al.[2] under experimental verification for a rigid robot when considering the motor dynamics. For the robust control of rigid robots with consideration of actuator dynamics can be found in [3]-[9]. Important developments for the adaptive control of electrically-driven rigid robots can be seen in [10]-[18].

The above mentioned schemes are all for the control of rigid robots. For the control of flexible-joint electrically driven robots, few results can be found. Some robust designs were presented in [19]-[22]. However, to our best knowledge, no work has been reported on adaptive control of flexible-joint robot manipulators incorporating motor dynamics. The main contribution of the present paper is to propose an adaptive controller for this system. The controller does not need to calculate the regressor[23] which is required in conventional robot adaptive control. The design follows a backstepping-like procedure with the support of the model reference adaptive control. The function approximation technique (FAT)[24]-[35] is employed to deal with the system uncertainties. A Lyapunov-like analysis is used to justify the closed-loop stability and boundedness of internal signals.

This paper is organized as follows. Section 2 derives the proposed adaptive motion controller in detail. Section 3 presents simulation results of the motion control of a 2-D robot using the proposed controller. Section 4 concludes the paper.

3. Main Results

The dynamics of a rigid-link flexible-joint electrically-driven (RLFJED) robot can be described by

$$\mathbf{D}(\mathbf{q})\ddot{\mathbf{q}} + \mathbf{C}(\mathbf{q}, \dot{\mathbf{q}})\dot{\mathbf{q}} + \mathbf{g}(\mathbf{q}) = \mathbf{K}(\boldsymbol{\theta} - \mathbf{q}) \quad (1)$$

$$\mathbf{J}\ddot{\boldsymbol{\theta}} + \mathbf{B}\dot{\boldsymbol{\theta}} + \mathbf{K}(\boldsymbol{\theta} - \mathbf{q}) = \mathbf{H}\mathbf{i} \quad (2)$$

$$\mathbf{L}\dot{\mathbf{i}} + \mathbf{R}(\mathbf{i}, \dot{\boldsymbol{\theta}}) = \mathbf{u} \quad (3)$$

where $\mathbf{q} \in \mathfrak{R}^n$ is the vector of link angles, $\boldsymbol{\theta} \in \mathfrak{R}^n$ is the vector of actuator angles, $\mathbf{i} \in \mathfrak{R}^n$ is the motor armature currents, $\mathbf{u} \in \mathfrak{R}^n$ is the control input voltage, $\mathbf{D}(\mathbf{q})$ is the $n \times n$ inertia matrix, $\mathbf{C}(\mathbf{q}, \dot{\mathbf{q}})\dot{\mathbf{q}}$ is an n -vector of centrifugal and Coriolis forces, and $\mathbf{g}(\mathbf{q})$ is the gravity vector. \mathbf{J} , \mathbf{B} and \mathbf{K} are $n \times n$ constant diagonal matrices of actuator inertia, damping and joint stiffness, respectively. $\mathbf{H} \in \mathfrak{R}^{n \times n}$ is an invertible constant diagonal matrix which characterizes the electro-mechanical conversion between current and torque, $\mathbf{L} \in \mathfrak{R}^{n \times n}$ is the constant diagonal matrix of electrical inductance, $\mathbf{R}(\mathbf{i}, \dot{\boldsymbol{\theta}}) \in \mathfrak{R}^n$

represents the effect of the electrical resistance and the motor back-emf. Here, we would like to consider the case when the precise forms of $\mathbf{D}(\mathbf{q})$, $\mathbf{C}(\mathbf{q}, \dot{\mathbf{q}})\dot{\mathbf{q}}$, $\mathbf{g}(\mathbf{q})$, \mathbf{L} and $\mathbf{R}(\mathbf{i}, \dot{\boldsymbol{\theta}})$ are not available and their variation bounds are not given. This implies that traditional adaptive control and robust control cannot be applicable. In the following, we would like to use the FAT to design an adaptive controller for the robot. Moreover, it is well-known that derivation of the regressor matrix for the adaptive control of high DOF rigid robot is generally tedious. For the RLFJED robot in (1), (2), and (3) its dynamics is much more complex than that of its rigid-joint counterpart. Therefore, the computation of the regressor matrix becomes extremely difficult. One of the contributions of the present paper is to propose an adaptive controller which does not need to calculate the regressor matrix needed in the conventional robot adaptive control.

Define $\boldsymbol{\tau}_t = \mathbf{K}(\boldsymbol{\theta} - \mathbf{q})$ [36,37] to be the vector of transmission torques, so (1) and (2) becomes

$$\mathbf{D}(\mathbf{q})\ddot{\mathbf{q}} + \mathbf{C}(\mathbf{q}, \dot{\mathbf{q}})\dot{\mathbf{q}} + \mathbf{g}(\mathbf{q}) = \boldsymbol{\tau}_t \quad (4)$$

$$\mathbf{J}_t \ddot{\boldsymbol{\tau}}_t + \mathbf{B}_t \dot{\boldsymbol{\tau}}_t + \boldsymbol{\tau}_t = \mathbf{H}\mathbf{i} - \bar{\mathbf{q}}(\dot{\mathbf{q}}, \ddot{\mathbf{q}}) \quad (5)$$

where $\mathbf{J}_t = \mathbf{J}\mathbf{K}^{-1}$, $\mathbf{B}_t = \mathbf{B}\mathbf{K}^{-1}$ and $\bar{\mathbf{q}}(\dot{\mathbf{q}}, \ddot{\mathbf{q}}) = \mathbf{J}\ddot{\mathbf{q}} + \mathbf{B}\dot{\mathbf{q}}$. Define signal vector $\mathbf{s} = \dot{\mathbf{e}} + \boldsymbol{\Lambda}\mathbf{e}$ and $\mathbf{v} = \dot{\mathbf{q}}_d - \boldsymbol{\Lambda}\mathbf{e}$, where $\mathbf{q}_d \in \mathfrak{R}^n$ is the vector of desired states, $\mathbf{e} = \mathbf{q} - \mathbf{q}_d$ is the state error, and $\boldsymbol{\Lambda} = \text{diag}(\lambda_1, \lambda_2, \dots, \lambda_n)$ with $\lambda_i > 0$ for all $i=1, \dots, n$. Rewrite (4) in the form

$$\mathbf{D}\dot{\mathbf{s}} + \mathbf{C}\mathbf{s} + \mathbf{g} + \mathbf{D}\dot{\mathbf{v}} + \mathbf{C}\mathbf{v} = \boldsymbol{\tau}_t \quad (6)$$

A. Controller Design for Known Robot

Suppose $\mathbf{D}(\mathbf{q})$, $\mathbf{C}(\mathbf{q}, \dot{\mathbf{q}})\dot{\mathbf{q}}$ and $\mathbf{g}(\mathbf{q})$ are known, and we may design a proper control law such that $\boldsymbol{\tau}$ follows the trajectory below

$$\boldsymbol{\tau}_t = \mathbf{g} + \mathbf{D}\dot{\mathbf{v}} + \mathbf{C}\mathbf{v} - \mathbf{K}_d \mathbf{s} \quad (7)$$

where \mathbf{K}_d is a positive definite matrix. Substituting (7) into (6), the closed loop dynamics

becomes $\mathbf{D}\dot{\mathbf{s}} + \mathbf{C}\mathbf{s} + \mathbf{K}_d \mathbf{s} = \mathbf{0}$. Define a Lyapunov function candidate as $V = \frac{1}{2} \mathbf{s}^T \mathbf{D}\mathbf{s}$.

Its time derivative along the trajectory of the closed loop dynamics can be computed as $\dot{V} = -\mathbf{s}^T \mathbf{K}_d \mathbf{s} + \mathbf{s}^T (\dot{\mathbf{D}} - 2\mathbf{C})\mathbf{s}$. Since $\dot{\mathbf{D}} - 2\mathbf{C}$ can be proved to be skew-symmetric, the above equation becomes $\dot{V} = -\mathbf{s}^T \mathbf{K}_d \mathbf{s} \leq 0$. It is easy to prove that \mathbf{s} is uniformly bounded and square integrable, and $\dot{\mathbf{s}}$ is also uniformly bounded. Hence, $\mathbf{s} \rightarrow \mathbf{0}$ as $t \rightarrow \infty$, or we may say $\mathbf{e} \rightarrow \mathbf{0}$ as $t \rightarrow \infty$. To make the actual $\boldsymbol{\tau}$ converge to the perfect $\boldsymbol{\tau}$ in (7), let us consider the reference model

$$\mathbf{J}_r \ddot{\boldsymbol{\tau}}_r + \mathbf{B}_r \dot{\boldsymbol{\tau}}_r + \mathbf{K}_r \boldsymbol{\tau}_r = \mathbf{J}_r \ddot{\boldsymbol{\tau}}_{td} + \mathbf{B}_r \dot{\boldsymbol{\tau}}_{td} + \mathbf{K}_r \boldsymbol{\tau}_{td} \quad (8)$$

where $\boldsymbol{\tau}_r \in \mathfrak{R}^n$ is the state vector of the reference model and $\boldsymbol{\tau}_{td} \in \mathfrak{R}^n$ is the vector of desired states. Matrices $\mathbf{J}_r \in \mathfrak{R}^{n \times n}$, $\mathbf{B}_r \in \mathfrak{R}^{n \times n}$ and $\mathbf{K}_r \in \mathfrak{R}^{n \times n}$ are selected such that $\boldsymbol{\tau}_r \rightarrow \boldsymbol{\tau}_{td}$ exponentially. Define $\bar{\boldsymbol{\tau}}_{td}(\dot{\boldsymbol{\tau}}_{td}, \ddot{\boldsymbol{\tau}}_{td}) = \mathbf{K}_r^{-1}(\mathbf{B}_r \dot{\boldsymbol{\tau}}_{td} + \mathbf{J}_r \ddot{\boldsymbol{\tau}}_{td})$, we may rewrite (5) and (8) in the state space form as

$$\dot{\mathbf{x}}_p = \mathbf{A}_p \mathbf{x}_p + \mathbf{B}_p \mathbf{H} \mathbf{i} - \mathbf{B}_p \bar{\mathbf{q}} \quad (9)$$

$$\dot{\mathbf{x}}_m = \mathbf{A}_m \mathbf{x}_m + \mathbf{B}_m (\boldsymbol{\tau}_{td} + \bar{\boldsymbol{\tau}}_{td}) \quad (10)$$

where $\mathbf{x}_p = [\boldsymbol{\tau}_t \quad \dot{\boldsymbol{\tau}}_t]^T \in \mathfrak{R}^{2n}$ and $\mathbf{x}_m = [\boldsymbol{\tau}_r \quad \dot{\boldsymbol{\tau}}_r]^T \in \mathfrak{R}^{2n}$ are augmented state

vectors. $\mathbf{A}_p = \begin{bmatrix} \mathbf{0} & \mathbf{I}_{n \times n} \\ -\mathbf{J}_t^{-1} & -\mathbf{J}_t^{-1} \mathbf{B}_t \end{bmatrix} \in \mathfrak{R}^{2n \times 2n}$ and

$\mathbf{A}_m = \begin{bmatrix} \mathbf{0} & \mathbf{I}_{n \times n} \\ -\mathbf{J}_r^{-1} \mathbf{K}_r & -\mathbf{J}_r^{-1} \mathbf{B}_r \end{bmatrix} \in \mathfrak{R}^{2n \times 2n}$ are augmented system matrices.

$\mathbf{B}_p = \begin{bmatrix} \mathbf{0} \\ \mathbf{J}_t^{-1} \end{bmatrix} \in \mathfrak{R}^{2n \times n}$ and $\mathbf{B}_m = \begin{bmatrix} \mathbf{0} \\ \mathbf{J}_r^{-1} \mathbf{K}_r \end{bmatrix} \in \mathfrak{R}^{2n \times n}$ are augmented input gain

matrices, and the pair $(\mathbf{A}_m, \mathbf{B}_m)$ is controllable. Since all system parameters are assumed to be available at the present stage, we may select a perfect current trajectory in the form [38]

$$\mathbf{i} = \mathbf{H}^{-1} [\boldsymbol{\Theta} \mathbf{x}_p + \boldsymbol{\Phi} \boldsymbol{\tau}_{td} + \mathbf{h}(\bar{\boldsymbol{\tau}}_{td}, \bar{\mathbf{q}})] \quad (11)$$

where $\boldsymbol{\Theta} \in \mathfrak{R}^{n \times 2n}$ and $\boldsymbol{\Phi} \in \mathfrak{R}^{n \times n}$ satisfy $\mathbf{A}_p + \mathbf{B}_p \boldsymbol{\Theta} = \mathbf{A}_m$ and $\mathbf{B}_p \boldsymbol{\Phi} = \mathbf{B}_m$, respectively, and $\mathbf{h}(\bar{\boldsymbol{\tau}}_{td}, \bar{\mathbf{q}}) = \boldsymbol{\Phi} \bar{\boldsymbol{\tau}}_{td} + \bar{\mathbf{q}}$. Substituting (11) into (9) and after some rearrangements, we may have the system dynamics

$$\dot{\mathbf{x}}_p = \mathbf{A}_m \mathbf{x}_p + \mathbf{B}_m (\boldsymbol{\tau}_{td} + \bar{\boldsymbol{\tau}}_{td}) \quad (12)$$

Define $\mathbf{e}_m = \mathbf{x}_p - \mathbf{x}_m$ and we may have the error dynamics directly from (10) and (12)

$$\dot{\mathbf{e}}_m = \mathbf{A}_m \mathbf{e}_m \quad (13)$$

Let $\mathbf{e}_\tau = \boldsymbol{\tau}_t - \boldsymbol{\tau}_r$ be the output vector of the error dynamics (13) as

$$\mathbf{e}_\tau = \mathbf{C}_m \mathbf{e}_m \quad (14)$$

where $\mathbf{C}_m \in \mathcal{R}^{n \times 2n}$ is the augmented output matrix such that the pair $(\mathbf{A}_m, \mathbf{C}_m)$ is observable and the transfer function $\mathbf{C}_m (s\mathbf{I} - \mathbf{A}_m)^{-1} \mathbf{B}_m$ is strictly positive real. Since \mathbf{A}_m is stable, (13) implies $\mathbf{e}_m \rightarrow \mathbf{0}$ as $t \rightarrow \infty$. This further gives $\boldsymbol{\tau}_t \rightarrow \boldsymbol{\tau}_{td}$ as $t \rightarrow \infty$. To ensure the actual \mathbf{i} to converge to the perfect \mathbf{i} in (11), let us select the control input in (3) as

$$\mathbf{u} = \mathbf{L}\dot{\mathbf{i}}_d + \mathbf{R}(\mathbf{i}, \dot{\boldsymbol{\theta}}) - \mathbf{K}_c \mathbf{e}_i \quad (15)$$

where $\mathbf{e}_i = \mathbf{i} - \mathbf{i}_d$ is the current error, $\mathbf{i}_d \in \mathcal{R}^n$ is the desired current which is equivalent to the perfect current trajectory \mathbf{i} in (11), and $\mathbf{K}_c \in \mathcal{R}^{n \times n}$ is a positive definite matrix. Substituting (15) into (3), the closed loop dynamics becomes $\mathbf{L}\dot{\mathbf{e}}_i + \mathbf{K}_c \mathbf{e}_i = \mathbf{0}$. According to this, it is easy to prove that $\mathbf{i} \rightarrow \mathbf{i}_d$ as $t \rightarrow \infty$ with proper selection of \mathbf{K}_c .

In summary, if all parameters in the RLFJED robot (1), (2), and (3) are available, the desired transmission torque (7), the desired current (11), the control input (15) can give asymptotic convergence tracking performance.

B. Controller Design for Uncertain Robot

Suppose $\mathbf{D}(\mathbf{q})$, $\mathbf{C}(\mathbf{q}, \dot{\mathbf{q}})\dot{\mathbf{q}}$, $\mathbf{g}(\mathbf{q})$, \mathbf{L} and $\mathbf{R}(\mathbf{i}, \dot{\boldsymbol{\theta}})$ are not available, and $\ddot{\mathbf{q}}, \ddot{\boldsymbol{\theta}}$ are not easy to measure, we would like to design a desired transmission torque $\boldsymbol{\tau}_d$ so that a proper controller \mathbf{u} can be constructed to have $\boldsymbol{\tau}_t \rightarrow \boldsymbol{\tau}_{td}$. Instead of (7), let us design a desired transmission torque $\boldsymbol{\tau}_{td}$ as

$$\boldsymbol{\tau}_{td} = \hat{\mathbf{g}} + \hat{\mathbf{D}}\dot{\mathbf{v}} + \hat{\mathbf{C}}\mathbf{v} - \mathbf{K}_d \mathbf{s} \quad (16)$$

where $\hat{\mathbf{D}}, \hat{\mathbf{C}}$ and $\hat{\mathbf{g}}$ are estimates of $\mathbf{D}(\mathbf{q}), \mathbf{C}(\mathbf{q}, \dot{\mathbf{q}})$ and $\mathbf{g}(\mathbf{q})$, respectively. Using (16), we may have the closed loop dynamics

$$\mathbf{D}\dot{\mathbf{s}} + \mathbf{C}\mathbf{s} + \mathbf{K}_d \mathbf{s} = -\tilde{\mathbf{D}}\dot{\mathbf{v}} - \tilde{\mathbf{C}}\mathbf{v} - \tilde{\mathbf{g}} + (\boldsymbol{\tau}_t - \boldsymbol{\tau}_{td}) \quad (17)$$

where $\tilde{\mathbf{D}} = \mathbf{D} - \hat{\mathbf{D}}, \tilde{\mathbf{C}} = \mathbf{C} - \hat{\mathbf{C}}$ and $\tilde{\mathbf{g}} = \mathbf{g} - \hat{\mathbf{g}}$. If a proper controller and update laws for $\hat{\mathbf{D}}, \hat{\mathbf{C}}$ and $\hat{\mathbf{g}}$ can be designed, we may have $\boldsymbol{\tau}_t \rightarrow \boldsymbol{\tau}_{td}, \hat{\mathbf{D}} \rightarrow \mathbf{D}, \hat{\mathbf{C}} \rightarrow \mathbf{C}$ and $\hat{\mathbf{g}} \rightarrow \mathbf{g}$ so that (17) can give desired performance. Let us consider the desired current \mathbf{i}_d instead of (11)

$$\mathbf{i}_d = \mathbf{H}^{-1}(\Theta \mathbf{x}_p + \Phi \boldsymbol{\tau}_d + \hat{\mathbf{h}}) \quad (18)$$

where $\hat{\mathbf{h}}$ is an estimate of \mathbf{h} . By (18), we may have the system dynamics

$$\dot{\mathbf{x}}_p = \mathbf{A}_m \mathbf{x}_p + \mathbf{B}_m (\boldsymbol{\tau}_d + \bar{\boldsymbol{\tau}}_d) + \mathbf{B}_p \mathbf{H}(\mathbf{i} - \mathbf{i}_d) + \mathbf{B}_p (\hat{\mathbf{h}} - \mathbf{h}) \quad (19)$$

Together with (10), we may have the error dynamics

$$\dot{\mathbf{e}}_m = \mathbf{A}_m \mathbf{e}_m + \mathbf{B}_p [\mathbf{H} \mathbf{e}_i + (\hat{\mathbf{h}} - \mathbf{h})] \quad (20)$$

$$\mathbf{e}_\tau = \mathbf{C}_m \mathbf{e}_m \quad (21)$$

If we may design a control input \mathbf{u} and an appropriate update law such that $\mathbf{i} \rightarrow \mathbf{i}_d$ and $\hat{\mathbf{h}} \rightarrow \mathbf{h}$, then (20) implies $\mathbf{e}_m \rightarrow \mathbf{0}$ as $t \rightarrow \infty$. This further implies $\boldsymbol{\tau}_t \rightarrow \boldsymbol{\tau}_{td}$ as $t \rightarrow \infty$. Here, according to (15), let us select the control input in (3) as

$$\mathbf{u} = \hat{\mathbf{f}} - \mathbf{K}_c \mathbf{e}_i \quad (22)$$

where $\hat{\mathbf{f}}$ is an estimate of $\mathbf{f}(\mathbf{i}_d, \mathbf{i}, \hat{\boldsymbol{\theta}}) = \mathbf{L} \mathbf{i}_d + \mathbf{R}(\mathbf{i}, \hat{\boldsymbol{\theta}})$. Substituting (22) into (3), we may have the system dynamics

$$\mathbf{L} \dot{\mathbf{e}}_i + \mathbf{K}_c \mathbf{e}_i = \hat{\mathbf{f}} - \mathbf{f} \quad (23)$$

If an appropriate update law for $\hat{\mathbf{f}}$ can be selected, we may have $\mathbf{i} \rightarrow \mathbf{i}_d$. Since \mathbf{D} , \mathbf{C} , \mathbf{g} , \mathbf{h} and \mathbf{f} are functions of time, traditional adaptive controllers are not directly applicable. To design the update laws, let us apply the function approximation representation

$$\mathbf{D} = \mathbf{W}_D^T \mathbf{Z}_D + \boldsymbol{\varepsilon}_D, \quad \mathbf{C} = \mathbf{W}_C^T \mathbf{Z}_C + \boldsymbol{\varepsilon}_C, \quad \mathbf{g} = \mathbf{W}_g^T \mathbf{Z}_g + \boldsymbol{\varepsilon}_g, \quad (24a)$$

$$\mathbf{h} = \mathbf{W}_h^T \mathbf{Z}_h + \boldsymbol{\varepsilon}_h, \quad \mathbf{f} = \mathbf{W}_f^T \mathbf{Z}_f + \boldsymbol{\varepsilon}_f$$

where $\mathbf{W}_D \in \mathcal{R}^{n^2 \beta_D \times n}$, $\mathbf{W}_C \in \mathcal{R}^{n^2 \beta_C \times n}$, $\mathbf{W}_g \in \mathcal{R}^{n \beta_g \times n}$, $\mathbf{W}_h \in \mathcal{R}^{n \beta_h \times n}$, and $\mathbf{W}_f \in \mathcal{R}^{n \beta_f \times n}$ are weighting matrices, $\mathbf{Z}_D \in \mathcal{R}^{n^2 \beta_D \times n}$, $\mathbf{Z}_C \in \mathcal{R}^{n^2 \beta_C \times n}$, $\mathbf{Z}_g \in \mathcal{R}^{n \beta_g \times 1}$, $\mathbf{Z}_h \in \mathcal{R}^{n \beta_h \times 1}$ and $\mathbf{Z}_f \in \mathcal{R}^{n \beta_f \times 1}$ are matrices of basis functions, and $\boldsymbol{\varepsilon}_{(\cdot)}$ are approximation error matrices. The number $\beta_{(\cdot)}$ represents the number of basis functions used. Using the same set of basis functions, the corresponding estimates can also be represented as

$$\begin{aligned} \hat{\mathbf{D}} &= \hat{\mathbf{W}}_D^T \mathbf{Z}_D, & \hat{\mathbf{C}} &= \hat{\mathbf{W}}_C^T \mathbf{Z}_C, & \hat{\mathbf{g}} &= \hat{\mathbf{W}}_g^T \mathbf{Z}_g, \\ \hat{\mathbf{h}} &= \hat{\mathbf{W}}_h^T \mathbf{Z}_h, & \hat{\mathbf{f}} &= \hat{\mathbf{W}}_f^T \mathbf{Z}_f \end{aligned} \quad (24b)$$

Define $\tilde{\mathbf{W}}_{(\cdot)} = \mathbf{W}_{(\cdot)} - \hat{\mathbf{W}}_{(\cdot)}$, then equation (17), (20) and (23) becomes

$$\mathbf{D}\dot{\mathbf{s}} + \mathbf{C}\mathbf{s} + \mathbf{K}_d\mathbf{s} = (\boldsymbol{\tau}_t - \boldsymbol{\tau}_{td}) - \tilde{\mathbf{W}}_D^T \mathbf{Z}_D \dot{\mathbf{v}} - \tilde{\mathbf{W}}_C^T \mathbf{Z}_C \mathbf{v} - \tilde{\mathbf{W}}_g^T \mathbf{Z}_g + \boldsymbol{\varepsilon}_1 \quad (25)$$

$$\dot{\mathbf{e}}_m = \mathbf{A}_m \mathbf{e}_m - \mathbf{B}_p \tilde{\mathbf{W}}_h^T \mathbf{Z}_h + \mathbf{B}_p \mathbf{H} \mathbf{e}_i + \mathbf{B}_p \boldsymbol{\varepsilon}_2 \quad (26)$$

$$\mathbf{L} \dot{\mathbf{e}}_i + \mathbf{K}_c \mathbf{e}_i = -\tilde{\mathbf{W}}_f^T \mathbf{Z}_f + \boldsymbol{\varepsilon}_3 \quad (27)$$

where $\boldsymbol{\varepsilon}_1 = \boldsymbol{\varepsilon}_1(\boldsymbol{\varepsilon}_D, \boldsymbol{\varepsilon}_C, \boldsymbol{\varepsilon}_g, \mathbf{s}, \ddot{\mathbf{q}}_d)$, $\boldsymbol{\varepsilon}_2 = \boldsymbol{\varepsilon}_2(\boldsymbol{\varepsilon}_h, \mathbf{e}_m)$ and $\boldsymbol{\varepsilon}_3 = \boldsymbol{\varepsilon}_3(\boldsymbol{\varepsilon}_f, \mathbf{e}_i)$ are lumped approximation errors. Since $\mathbf{W}_{(\cdot)}$ are constant matrices, their update laws can be easily found by proper selection of the Lyapunov-like function. Let us consider a candidate

$$V(\mathbf{s}, \mathbf{e}_m, \mathbf{e}_i, \tilde{\mathbf{W}}_D, \tilde{\mathbf{W}}_C, \tilde{\mathbf{W}}_g, \tilde{\mathbf{W}}_h, \tilde{\mathbf{W}}_f) = \frac{1}{2} \mathbf{s}^T \mathbf{D} \mathbf{s} + \mathbf{e}_m^T \mathbf{P}_t \mathbf{e}_m + \frac{1}{2} \mathbf{e}_i^T \mathbf{L} \mathbf{e}_i + \frac{1}{2} \text{Tr}(\tilde{\mathbf{W}}_D^T \mathbf{Q}_D \tilde{\mathbf{W}}_D + \tilde{\mathbf{W}}_C^T \mathbf{Q}_C \tilde{\mathbf{W}}_C + \tilde{\mathbf{W}}_g^T \mathbf{Q}_g \tilde{\mathbf{W}}_g + \tilde{\mathbf{W}}_h^T \mathbf{Q}_h \tilde{\mathbf{W}}_h + \tilde{\mathbf{W}}_f^T \mathbf{Q}_f \tilde{\mathbf{W}}_f) \quad (28)$$

where $\mathbf{P}_t = \mathbf{P}_t^T \in \mathfrak{R}^{2n \times 2n}$ is a positive definite matrix satisfying the Lyapunov equation $\mathbf{A}_m^T \mathbf{P}_t + \mathbf{P}_t \mathbf{A}_m = -\mathbf{C}_m^T \mathbf{C}_m$. The matrices $\mathbf{Q}_D \in \mathfrak{R}^{n^2 \beta_D \times n^2 \beta_D}$, $\mathbf{Q}_C \in \mathfrak{R}^{n^2 \beta_C \times n^2 \beta_C}$, $\mathbf{Q}_g \in \mathfrak{R}^{n \beta_g \times n \beta_g}$, $\mathbf{Q}_h \in \mathfrak{R}^{n \beta_h \times n \beta_h}$ and $\mathbf{Q}_f \in \mathfrak{R}^{n \beta_f \times n \beta_f}$ are positive definite. The notation $\text{Tr}(\cdot)$ denotes the trace operation of matrices. The time derivative of V along the trajectory of (25), (26), and (27) can be computed as

$$\begin{aligned} \dot{V} &= \mathbf{s}^T \mathbf{D} \dot{\mathbf{s}} + \frac{1}{2} \mathbf{s}^T \dot{\mathbf{D}} \mathbf{s} + \dot{\mathbf{e}}_m^T \mathbf{P}_t \mathbf{e}_m + \mathbf{e}_m^T \mathbf{P}_t \dot{\mathbf{e}}_m + \mathbf{e}_i^T \mathbf{L} \dot{\mathbf{e}}_i \\ &\quad - \text{Tr}(\tilde{\mathbf{W}}_D^T \mathbf{Q}_D \dot{\tilde{\mathbf{W}}}_D + \tilde{\mathbf{W}}_C^T \mathbf{Q}_C \dot{\tilde{\mathbf{W}}}_C + \tilde{\mathbf{W}}_g^T \mathbf{Q}_g \dot{\tilde{\mathbf{W}}}_g + \tilde{\mathbf{W}}_h^T \mathbf{Q}_h \dot{\tilde{\mathbf{W}}}_h + \tilde{\mathbf{W}}_f^T \mathbf{Q}_f \dot{\tilde{\mathbf{W}}}_f) \\ &= -\mathbf{s}^T \mathbf{K}_d \mathbf{s} + \mathbf{s}^T \mathbf{e}_\tau - \mathbf{e}_\tau^T \mathbf{e}_\tau + \mathbf{e}_m^T \mathbf{P}_t \mathbf{B}_p \mathbf{H} \mathbf{e}_i - \mathbf{e}_i^T \mathbf{K}_c \mathbf{e}_i + \mathbf{s}^T \boldsymbol{\varepsilon}_1 + \mathbf{e}_m^T \mathbf{P}_t \mathbf{B}_p \boldsymbol{\varepsilon}_2 + \mathbf{e}_i^T \boldsymbol{\varepsilon}_3 \\ &\quad - \text{Tr}[\tilde{\mathbf{W}}_D^T (\mathbf{Z}_D \dot{\mathbf{v}} \mathbf{s}^T + \mathbf{Q}_D \dot{\tilde{\mathbf{W}}}_D) + \tilde{\mathbf{W}}_C^T (\mathbf{Z}_C \mathbf{v} \mathbf{s}^T + \mathbf{Q}_C \dot{\tilde{\mathbf{W}}}_C)] \\ &\quad - \text{Tr}[\tilde{\mathbf{W}}_g^T (\mathbf{Z}_g \mathbf{s}^T + \mathbf{Q}_g \dot{\tilde{\mathbf{W}}}_g) + \tilde{\mathbf{W}}_h^T (\mathbf{Z}_h \mathbf{e}_m^T \mathbf{P}_t \mathbf{B}_p + \mathbf{Q}_h \dot{\tilde{\mathbf{W}}}_h)] \\ &\quad - \text{Tr}[\tilde{\mathbf{W}}_f^T (\mathbf{Z}_f \mathbf{e}_i^T + \mathbf{Q}_f \dot{\tilde{\mathbf{W}}}_f)] \end{aligned} \quad (29)$$

According to the Kalman-Yakubovic Lemma, we have $\mathbf{e}_m^T \mathbf{P}_t \mathbf{B}_p = \mathbf{e}_\tau^T$ by picking $\mathbf{B}_m = \mathbf{B}_p$ [39]. According to (29), the update laws can be selected as

$$\begin{aligned}
\dot{\hat{\mathbf{W}}}_D &= -\mathbf{Q}_D^{-1} \mathbf{Z}_D \dot{\mathbf{v}} \mathbf{s}^T - \sigma_D \hat{\mathbf{W}}_D, & \dot{\hat{\mathbf{W}}}_C &= -\mathbf{Q}_C^{-1} \mathbf{Z}_C \mathbf{v} \mathbf{s}^T - \sigma_C \hat{\mathbf{W}}_C, \\
\dot{\hat{\mathbf{W}}}_g &= -\mathbf{Q}_g^{-1} \mathbf{Z}_g \mathbf{s}^T - \sigma_g \hat{\mathbf{W}}_g, & \dot{\hat{\mathbf{W}}}_h &= -\mathbf{Q}_h^{-1} \mathbf{Z}_h \mathbf{e}_\tau^T - \sigma_h \hat{\mathbf{W}}_h, \\
\dot{\hat{\mathbf{W}}}_f &= -\mathbf{Q}_f^{-1} \mathbf{Z}_f \mathbf{e}_i^T - \sigma_f \hat{\mathbf{W}}_f
\end{aligned} \tag{30}$$

where $\sigma_{(\cdot)}$ are positive numbers. Then (29) becomes

$$\begin{aligned}
\dot{V} &= -\begin{bmatrix} \mathbf{s}^T & \mathbf{e}_\tau^T & \mathbf{e}_i^T \end{bmatrix} \mathbf{Q} \begin{bmatrix} \mathbf{s} \\ \mathbf{e}_\tau \\ \mathbf{e}_i \end{bmatrix} + \begin{bmatrix} \mathbf{s}^T & \mathbf{e}_\tau^T & \mathbf{e}_i^T \end{bmatrix} \begin{bmatrix} \boldsymbol{\varepsilon}_1 \\ \boldsymbol{\varepsilon}_2 \\ \boldsymbol{\varepsilon}_3 \end{bmatrix} \\
&+ \sigma_D \text{Tr}(\tilde{\mathbf{W}}_D^T \hat{\mathbf{W}}_D) + \sigma_C \text{Tr}(\tilde{\mathbf{W}}_C^T \hat{\mathbf{W}}_C) + \sigma_g \text{Tr}(\tilde{\mathbf{W}}_g^T \hat{\mathbf{W}}_g) \\
&+ \sigma_h \text{Tr}(\tilde{\mathbf{W}}_h^T \hat{\mathbf{W}}_h) + \sigma_f \text{Tr}(\tilde{\mathbf{W}}_f^T \hat{\mathbf{W}}_f)
\end{aligned} \tag{31}$$

where $\mathbf{Q} = \begin{bmatrix} \mathbf{K}_d & -\frac{1}{2} \mathbf{I}_{n \times n} & \mathbf{0} \\ -\frac{1}{2} \mathbf{I}_{n \times n} & \mathbf{I}_{n \times n} & -\frac{1}{2} \mathbf{H} \\ \mathbf{0} & -\frac{1}{2} \mathbf{H} & \mathbf{K}_c \end{bmatrix}$ is positive definite due to proper selections

of \mathbf{K}_d and \mathbf{K}_c . Owing to the existence of $\boldsymbol{\varepsilon}_1$, $\boldsymbol{\varepsilon}_2$, and $\boldsymbol{\varepsilon}_3$ the definiteness of \dot{V} cannot be determined. According to **Appendix Lemma A.1**, *Lemma A.4* and *Lemma A.7*, the right hand side of (31) can be divided into two parts to derive following inequalities

$$\begin{aligned}
& -\begin{bmatrix} \mathbf{s}^T & \mathbf{e}_\tau^T & \mathbf{e}_i^T \end{bmatrix} \mathbf{Q} \begin{bmatrix} \mathbf{s} \\ \mathbf{e}_\tau \\ \mathbf{e}_i \end{bmatrix} + \begin{bmatrix} \mathbf{s}^T & \mathbf{e}_\tau^T & \mathbf{e}_i^T \end{bmatrix} \begin{bmatrix} \boldsymbol{\varepsilon}_1 \\ \boldsymbol{\varepsilon}_2 \\ \boldsymbol{\varepsilon}_3 \end{bmatrix} \\
& \leq -\frac{1}{2} \left(\lambda_{\min}(\mathbf{Q}) \left\| \begin{bmatrix} \mathbf{s} \\ \mathbf{e}_\tau \\ \mathbf{e}_i \end{bmatrix} \right\|^2 - \frac{1}{\lambda_{\min}(\mathbf{Q})} \left\| \begin{bmatrix} \boldsymbol{\varepsilon}_1 \\ \boldsymbol{\varepsilon}_2 \\ \boldsymbol{\varepsilon}_3 \end{bmatrix} \right\|^2 \right)
\end{aligned} \tag{32a}$$

$$\text{Tr}(\tilde{\mathbf{W}}_D^T \hat{\mathbf{W}}_D) \leq \frac{1}{2} \text{Tr}(\mathbf{W}_D^T \mathbf{W}_D) - \frac{1}{2} \text{Tr}(\tilde{\mathbf{W}}_D^T \tilde{\mathbf{W}}_D) \tag{32b}$$

$$Tr(\tilde{\mathbf{W}}_c^T \hat{\mathbf{W}}_c) \leq \frac{1}{2} Tr(\mathbf{W}_c^T \mathbf{W}_c) - \frac{1}{2} Tr(\tilde{\mathbf{W}}_c^T \tilde{\mathbf{W}}_c) \quad (32c)$$

$$Tr(\tilde{\mathbf{W}}_g^T \hat{\mathbf{W}}_g) \leq \frac{1}{2} Tr(\mathbf{W}_g^T \mathbf{W}_g) - \frac{1}{2} Tr(\tilde{\mathbf{W}}_g^T \tilde{\mathbf{W}}_g) \quad (32d)$$

$$Tr(\tilde{\mathbf{W}}_h^T \hat{\mathbf{W}}_h) \leq \frac{1}{2} Tr(\mathbf{W}_h^T \mathbf{W}_h) - \frac{1}{2} Tr(\tilde{\mathbf{W}}_h^T \tilde{\mathbf{W}}_h) \quad (32e)$$

$$Tr(\tilde{\mathbf{W}}_f^T \hat{\mathbf{W}}_f) \leq \frac{1}{2} Tr(\mathbf{W}_f^T \mathbf{W}_f) - \frac{1}{2} Tr(\tilde{\mathbf{W}}_f^T \tilde{\mathbf{W}}_f) \quad (32f)$$

According to (28), we have

$$\begin{aligned} V &= \frac{1}{2} [\mathbf{s}^T \mathbf{D} \mathbf{s} + \mathbf{e}_i^T \mathbf{L} \mathbf{e}_i + 2\mathbf{e}_m^T \mathbf{P}_t \mathbf{e}_m \\ &\quad + Tr(\tilde{\mathbf{W}}_D^T \mathbf{Q}_D \tilde{\mathbf{W}}_D + \tilde{\mathbf{W}}_C^T \mathbf{Q}_C \tilde{\mathbf{W}}_C + \tilde{\mathbf{W}}_g^T \mathbf{Q}_g \tilde{\mathbf{W}}_g + \tilde{\mathbf{W}}_h^T \mathbf{Q}_h \tilde{\mathbf{W}}_h) + \tilde{\mathbf{W}}_f^T \mathbf{Q}_f \tilde{\mathbf{W}}_f] \\ &\leq \frac{1}{2} \left[\lambda_{\max}(\mathbf{A}) \left\| \begin{bmatrix} \mathbf{s} \\ \mathbf{e}_\tau \\ \mathbf{e}_i \end{bmatrix} \right\|^2 + \lambda_{\max}(\mathbf{Q}_D) Tr(\tilde{\mathbf{W}}_D^T \tilde{\mathbf{W}}_D) + \lambda_{\max}(\mathbf{Q}_C) Tr(\tilde{\mathbf{W}}_C^T \tilde{\mathbf{W}}_C) \right. \\ &\quad \left. + \lambda_{\max}(\mathbf{Q}_g) Tr(\tilde{\mathbf{W}}_g^T \tilde{\mathbf{W}}_g) + \lambda_{\max}(\mathbf{Q}_h) Tr(\tilde{\mathbf{W}}_h^T \tilde{\mathbf{W}}_h) + \lambda_{\max}(\mathbf{Q}_f) Tr(\tilde{\mathbf{W}}_f^T \tilde{\mathbf{W}}_f) \right] \end{aligned} \quad (33)$$

where $\mathbf{A} = \begin{bmatrix} \mathbf{D} & \mathbf{0} & \mathbf{0} \\ \mathbf{0} & 2\mathbf{C}_m^T \mathbf{P}_t \mathbf{C}_m & \mathbf{0} \\ \mathbf{0} & \mathbf{0} & \mathbf{L} \end{bmatrix}$. With (32) and (33), (31) can be further written as

$$\begin{aligned} \dot{V} &\leq -\alpha V + \frac{1}{2} \left\{ [\alpha \lambda_{\max}(\mathbf{A}) - \lambda_{\min}(\mathbf{Q})] \left\| \begin{bmatrix} \mathbf{s} \\ \mathbf{e}_\tau \\ \mathbf{e}_i \end{bmatrix} \right\|^2 + [\alpha \lambda_{\max}(\mathbf{Q}_D) - \sigma_D] Tr(\tilde{\mathbf{W}}_D^T \tilde{\mathbf{W}}_D) \right. \\ &\quad + [\alpha \lambda_{\max}(\mathbf{Q}_C) - \sigma_C] Tr(\tilde{\mathbf{W}}_C^T \tilde{\mathbf{W}}_C) + [\alpha \lambda_{\max}(\mathbf{Q}_g) - \sigma_g] Tr(\tilde{\mathbf{W}}_g^T \tilde{\mathbf{W}}_g) \\ &\quad + [\alpha \lambda_{\max}(\mathbf{Q}_h) - \sigma_h] Tr(\tilde{\mathbf{W}}_h^T \tilde{\mathbf{W}}_h) + [\alpha \lambda_{\max}(\mathbf{Q}_f) - \sigma_f] Tr(\tilde{\mathbf{W}}_f^T \tilde{\mathbf{W}}_f) \\ &\quad + \frac{1}{\lambda_{\min}(\mathbf{Q})} \left\| \begin{bmatrix} \boldsymbol{\varepsilon}_1 \\ \boldsymbol{\varepsilon}_2 \\ \boldsymbol{\varepsilon}_3 \end{bmatrix} \right\|^2 + \sigma_D Tr(\mathbf{W}_D^T \mathbf{W}_D) + \sigma_C Tr(\mathbf{W}_C^T \mathbf{W}_C) \\ &\quad \left. + \sigma_g Tr(\mathbf{W}_g^T \mathbf{W}_g) + \sigma_h Tr(\mathbf{W}_h^T \mathbf{W}_h) + \sigma_f Tr(\mathbf{W}_f^T \mathbf{W}_f) \right\} \end{aligned} \quad (34)$$

Although \mathbf{D} and \mathbf{L} are unknown, we know that $\exists \bar{D}$ and \underline{D} s.t. $\underline{D} \leq \|\mathbf{D}\| \leq \bar{D}$, $\exists \bar{L}$ and \underline{L} s.t. $\underline{L} \leq \|\mathbf{L}\| \leq \bar{L}$, $\exists \bar{\eta}_A, \underline{\eta}_A > 0$ s.t. $\lambda_{\max}(\mathbf{A}) \leq \bar{\eta}_A$ and $\lambda_{\min}(\mathbf{A}) \geq \underline{\eta}_A$ [40]. Picking $\alpha \leq \min \left\{ \frac{\lambda_{\min}(\mathbf{Q})}{\bar{\eta}_A}, \frac{\sigma_D}{\lambda_{\max}(\mathbf{Q}_D)}, \frac{\sigma_C}{\lambda_{\max}(\mathbf{Q}_C)}, \frac{\sigma_g}{\lambda_{\max}(\mathbf{Q}_g)}, \frac{\sigma_h}{\lambda_{\max}(\mathbf{Q}_h)}, \frac{\sigma_f}{\lambda_{\max}(\mathbf{Q}_f)} \right\}$,

then we have

$$\begin{aligned} \dot{V} \leq & -\alpha V + \frac{1}{2\lambda_{\min}(\mathbf{Q})} \left\| \begin{bmatrix} \boldsymbol{\varepsilon}_1 \\ \boldsymbol{\varepsilon}_2 \\ \boldsymbol{\varepsilon}_3 \end{bmatrix} \right\|^2 + \frac{1}{2} [\sigma_D \text{Tr}(\mathbf{W}_D^T \mathbf{W}_D) + \sigma_C \text{Tr}(\mathbf{W}_C^T \mathbf{W}_C) \\ & + \sigma_g \text{Tr}(\mathbf{W}_g^T \mathbf{W}_g) + \sigma_h \text{Tr}(\mathbf{W}_h^T \mathbf{W}_h) + \sigma_f \text{Tr}(\mathbf{W}_f^T \mathbf{W}_f)] \end{aligned} \quad (35)$$

Hence, $\dot{V} < 0$ whenever

$$\begin{aligned} (\mathbf{s}, \mathbf{e}_\tau, \mathbf{e}_i, \tilde{\mathbf{W}}_D, \tilde{\mathbf{W}}_C, \tilde{\mathbf{W}}_g, \tilde{\mathbf{W}}_h, \tilde{\mathbf{W}}_f) \in \{(\mathbf{s}, \mathbf{e}_\tau, \mathbf{e}_i, \tilde{\mathbf{W}}_D, \tilde{\mathbf{W}}_C, \tilde{\mathbf{W}}_g, \tilde{\mathbf{W}}_h, \tilde{\mathbf{W}}_f) \mid V > \\ \frac{1}{2\alpha} \left[\frac{1}{\lambda_{\min}(\mathbf{Q})} \sup_{\tau \geq t_0} \left\| \begin{bmatrix} \boldsymbol{\varepsilon}_1(\tau) \\ \boldsymbol{\varepsilon}_2(\tau) \\ \boldsymbol{\varepsilon}_3(\tau) \end{bmatrix} \right\|^2 + \sigma_D \text{Tr}(\mathbf{W}_D^T \mathbf{W}_D) + \sigma_C \text{Tr}(\mathbf{W}_C^T \mathbf{W}_C) \right. \\ \left. + \sigma_g \text{Tr}(\mathbf{W}_g^T \mathbf{W}_g) + \sigma_h \text{Tr}(\mathbf{W}_h^T \mathbf{W}_h) + \sigma_f \text{Tr}(\mathbf{W}_f^T \mathbf{W}_f) \right] \} \end{aligned}$$

This further concludes that \mathbf{s} , \mathbf{e}_τ , \mathbf{e}_i , $\tilde{\mathbf{W}}_D$, $\tilde{\mathbf{W}}_C$, $\tilde{\mathbf{W}}_g$, $\tilde{\mathbf{W}}_h$, and $\tilde{\mathbf{W}}_f$ are uniformly ultimately bounded (*u.u.b.*). The implementation of the desired transmission torque (16), desired current (18), control input (22) and update law (30) does not need to calculate the regressor matrix which is required in most adaptive designs for robot manipulators. The convergence of the parameters, however, can be proved to depend on the persistent excitation condition of the input.

The above derivation only demonstrates the boundedness of the closed loop system, but in practical applications the transient performance is also of great importance. For further development, we may apply the comparison lemma [40] to (35) to have the upper bound for V as

$$\begin{aligned} V(t) \leq & e^{-\alpha(t-t_0)} V(t_0) + \frac{1}{2\alpha} \left[\frac{1}{\lambda_{\min}(\mathbf{Q})} \sup_{t_0 < \tau < t} \left\| \begin{bmatrix} \boldsymbol{\varepsilon}_1(\tau) \\ \boldsymbol{\varepsilon}_2(\tau) \\ \boldsymbol{\varepsilon}_3(\tau) \end{bmatrix} \right\|^2 + \sigma_D \text{Tr}(\mathbf{W}_D^T \mathbf{W}_D) \right. \\ & \left. + \sigma_C \text{Tr}(\mathbf{W}_C^T \mathbf{W}_C) + \sigma_g \text{Tr}(\mathbf{W}_g^T \mathbf{W}_g) + \sigma_h \text{Tr}(\mathbf{W}_h^T \mathbf{W}_h) + \sigma_f \text{Tr}(\mathbf{W}_f^T \mathbf{W}_f) \right] \end{aligned} \quad (36)$$

From (28), we obtain

$$V \geq \frac{1}{2} \left[\lambda_{\min}(\mathbf{A}) \left\| \begin{bmatrix} \mathbf{s} \\ \mathbf{e}_\tau \\ \mathbf{e}_i \end{bmatrix} \right\|^2 + \lambda_{\min}(\mathbf{Q}_D) \text{Tr}(\tilde{\mathbf{W}}_D^T \tilde{\mathbf{W}}_D) + \lambda_{\min}(\mathbf{Q}_C) \text{Tr}(\tilde{\mathbf{W}}_C^T \tilde{\mathbf{W}}_C) \right. \\ \left. + \lambda_{\min}(\mathbf{Q}_g) \text{Tr}(\tilde{\mathbf{W}}_g^T \tilde{\mathbf{W}}_g) + \lambda_{\min}(\mathbf{Q}_h) \text{Tr}(\tilde{\mathbf{W}}_h^T \tilde{\mathbf{W}}_h) + \lambda_{\min}(\mathbf{Q}_f) \text{Tr}(\tilde{\mathbf{W}}_f^T \tilde{\mathbf{W}}_f) \right] \quad (37)$$

Thus, the bound of $\left\| \begin{bmatrix} \mathbf{s}^T & \mathbf{e}_\tau^T & \mathbf{e}_i^T \end{bmatrix}^T \right\|^2$ for $t \geq t_0$ can be derived from (36) and (37) as

$$\left\| \begin{bmatrix} \mathbf{s} \\ \mathbf{e}_\tau \\ \mathbf{e}_i \end{bmatrix} \right\|^2 \leq \frac{1}{\underline{\eta}_A} [V - \lambda_{\min}(\mathbf{Q}_D) \text{Tr}(\tilde{\mathbf{W}}_D^T \tilde{\mathbf{W}}_D) \\ - \lambda_{\min}(\mathbf{Q}_C) \text{Tr}(\tilde{\mathbf{W}}_C^T \tilde{\mathbf{W}}_C) - \lambda_{\min}(\mathbf{Q}_g) \text{Tr}(\tilde{\mathbf{W}}_g^T \tilde{\mathbf{W}}_g) \\ - \lambda_{\min}(\mathbf{Q}_h) \text{Tr}(\tilde{\mathbf{W}}_h^T \tilde{\mathbf{W}}_h) - \lambda_{\min}(\mathbf{Q}_f) \text{Tr}(\tilde{\mathbf{W}}_f^T \tilde{\mathbf{W}}_f)] \\ \leq \frac{1}{\underline{\eta}_A} \left\{ 2e^{-\alpha(t-t_0)} V(t_0) + \frac{1}{\alpha} \left[\frac{1}{\lambda_{\min}(\mathbf{Q})} \sup_{t_0 < \tau < t} \left\| \begin{bmatrix} \boldsymbol{\varepsilon}_1(\tau) \\ \boldsymbol{\varepsilon}_2(\tau) \\ \boldsymbol{\varepsilon}_3(\tau) \end{bmatrix} \right\|^2 \right. \right. \\ \left. \left. + \sigma_D \text{Tr}(\mathbf{W}_D^T \mathbf{W}_D) + \sigma_C \text{Tr}(\mathbf{W}_C^T \mathbf{W}_C) + \sigma_g \text{Tr}(\mathbf{W}_g^T \mathbf{W}_g) \right. \right. \\ \left. \left. + \sigma_h \text{Tr}(\mathbf{W}_h^T \mathbf{W}_h) + \sigma_f \text{Tr}(\mathbf{W}_f^T \mathbf{W}_f) \right] - \lambda_{\min}(\mathbf{Q}_D) \text{Tr}(\tilde{\mathbf{W}}_D^T \tilde{\mathbf{W}}_D) \right. \\ \left. - \lambda_{\min}(\mathbf{Q}_C) \text{Tr}(\tilde{\mathbf{W}}_C^T \tilde{\mathbf{W}}_C) - \lambda_{\min}(\mathbf{Q}_g) \text{Tr}(\tilde{\mathbf{W}}_g^T \tilde{\mathbf{W}}_g) \right. \\ \left. - \lambda_{\min}(\mathbf{Q}_h) \text{Tr}(\tilde{\mathbf{W}}_h^T \tilde{\mathbf{W}}_h) - \lambda_{\min}(\mathbf{Q}_f) \text{Tr}(\tilde{\mathbf{W}}_f^T \tilde{\mathbf{W}}_f) \right\} \quad (38)$$

From the derivations above, we can conclude that the proposed design is able to give bounded tracking with guaranteed transient performance. The following theorem is a summary of the above results.

Theorem 1: Consider the RLFJED robot (1)-(3) with unknown parameters \mathbf{D} , \mathbf{C} , \mathbf{g} , \mathbf{L} and \mathbf{R} , then desired transmission torque (16), desired current (18), control input (22) and update law (30) ensure that

- (i) error signals \mathbf{s} , \mathbf{e}_τ , \mathbf{e}_i , $\tilde{\mathbf{W}}_D$, $\tilde{\mathbf{W}}_C$, $\tilde{\mathbf{W}}_g$, $\tilde{\mathbf{W}}_h$, and $\tilde{\mathbf{W}}_f$ are *u.u.b.*
- (ii) the bound of the tracking error vectors for $t \geq t_0$ can be derived as the form of (38), if the Lyapunov-like function candidates are chosen as (28).

Remark 1: The term with $\sigma_{(\cdot)}$ in (30) is to modify the update law to robust the closed-loop system for the effect of the approximation error[26]. Suppose a sufficient number of basis functions $\beta_{(\cdot)}$ is selected so that the approximation error can be neglected then we may have $\sigma_{(\cdot)} = 0$, and (31) becomes

$$\dot{V} = -\begin{bmatrix} \mathbf{s}^T & \mathbf{e}_\tau^T & \mathbf{e}_i^T \end{bmatrix} \mathbf{Q} \begin{bmatrix} \mathbf{s} \\ \mathbf{e}_\tau \\ \mathbf{e}_i \end{bmatrix} \leq 0 \quad (39)$$

It is easy to prove that \mathbf{s} , \mathbf{e}_τ , and \mathbf{e}_i are also square integrable. From (25), (26) and (27), $\dot{\mathbf{s}}$, $\dot{\mathbf{e}}_\tau$ and $\dot{\mathbf{e}}_i$ are bounded; as a result, asymptotic convergence of \mathbf{s} , \mathbf{e}_τ and \mathbf{e}_i can easily be shown by Barbalat's lemma. This further implies that $\mathbf{i} \rightarrow \mathbf{i}_d$, $\boldsymbol{\tau}_t \rightarrow \boldsymbol{\tau}_{td}$ and $\mathbf{q} \rightarrow \mathbf{q}_d$ even though \mathbf{D} , \mathbf{C} , \mathbf{g} , \mathbf{h} , \mathbf{L} , and \mathbf{f} are all unknown.

Remark 2: Suppose $\boldsymbol{\varepsilon}_1$, $\boldsymbol{\varepsilon}_2$, and $\boldsymbol{\varepsilon}_3$ cannot be ignored but their variation bounds are available[25,26] i.e. there exists positive constants δ_1 , δ_2 and δ_3 such that $\|\boldsymbol{\varepsilon}_1\| \leq \delta_1$, $\|\boldsymbol{\varepsilon}_2\| \leq \delta_2$ and $\|\boldsymbol{\varepsilon}_3\| \leq \delta_3$. To cover the effect of these bounded approximation errors, the desired transmission torque (16), the desired current (18), and the control input (22) are modified to be

$$\boldsymbol{\tau}_{td} = \hat{\mathbf{g}} + \hat{\mathbf{D}}\dot{\mathbf{v}} + \hat{\mathbf{C}}\mathbf{v} - \mathbf{K}_d \mathbf{s} + \boldsymbol{\tau}_{robust1} \quad (40)$$

$$\mathbf{i}_d = \mathbf{H}^{-1}[\boldsymbol{\Theta}\mathbf{x}_p + \boldsymbol{\Phi}\boldsymbol{\tau}_{td} + \hat{\mathbf{h}} + \boldsymbol{\tau}_{robust2}] \quad (41)$$

$$\mathbf{u} = \hat{\mathbf{f}} - \mathbf{K}_c \mathbf{e}_i + \boldsymbol{\tau}_{robust3}, \quad \mathbf{e}_i = \mathbf{i} - \mathbf{i}_d \quad (42)$$

where $\boldsymbol{\tau}_{robust1}$, $\boldsymbol{\tau}_{robust2}$ and $\boldsymbol{\tau}_{robust3}$ are robust terms to be designed. Let us consider the Lyapunov-like function candidate (28) and the update law (30) again. The time derivative of V can be computed as

$$\begin{aligned} \dot{V} = & -\begin{bmatrix} \mathbf{s}^T & \mathbf{e}_\tau^T & \mathbf{e}_i^T \end{bmatrix} \mathbf{Q} \begin{bmatrix} \mathbf{s} \\ \mathbf{e}_\tau \\ \mathbf{e}_i \end{bmatrix} + \delta_1 \|\mathbf{s}\| + \delta_2 \|\mathbf{e}_\tau\| + \delta_3 \|\mathbf{e}_i\| \\ & + \mathbf{s}^T \boldsymbol{\tau}_{robust1} + \mathbf{e}_\tau^T \boldsymbol{\tau}_{robust2} + \mathbf{e}_i^T \boldsymbol{\tau}_{robust3} \end{aligned} \quad (43)$$

By picking $\boldsymbol{\tau}_{robust1} = -\delta_1[\text{sgn}(s_1) \ \cdots \ \text{sgn}(s_n)]^T$, where s_k , $k=1, \dots, n$ is the k -th element of \mathbf{s} , $\boldsymbol{\tau}_{robust2} = -\delta_2[\text{sgn}(e_{\tau_1}) \ \cdots \ \text{sgn}(e_{\tau_n})]^T$ where e_{τ_k} , $k=1, \dots, 2n$ is the k -th

element of \mathbf{e}_v and $\boldsymbol{\tau}_{robust3} = -\delta_3[\text{sgn}(e_{i_1}) \cdots \text{sgn}(e_{i_n})]^T$, where e_{i_k} , $k=1, \dots, n$ is the k -th element of \mathbf{e}_i , we may have $\dot{V} \leq 0$, and asymptotic convergence of the state error can be concluded by Barbalat's lemma.

4. Simulation Study

Consider a 2-DOF planar robot (Fig.1) represented by the differential equation (1), (2) and (3). The quantities m_i , l_i , l_{ci} and I_i are mass, length, gravity center distance and inertia of link i , respectively. Actual values of link parameters in the simulation[34] are $m_1=0.5\text{kg}$, $m_2=0.5\text{kg}$, $l_1=l_2=0.75\text{m}$, $l_{c1}=l_{c2}=0.375\text{m}$, $I_1=0.09375\text{kg}\cdot\text{m}^2$, and $I_2=0.046975\text{kg}\cdot\text{m}^2$. The actuator inertias, damping, and joint stiffness are $\mathbf{J} = \text{diag}(0.02, 0.01)(\text{kg}\cdot\text{m}^2)$, $\mathbf{B} = \text{diag}(5, 4)(\text{Nm}\cdot\text{sec}/\text{rad})$ and $\mathbf{K} = \text{diag}(100, 100)(\text{Nm}/\text{rad})$ respectively. The motor parameters are: $\mathbf{L} = \text{diag}(0.025, 0.025)(\text{H})$, $\mathbf{H} = \text{diag}(10, 10)(\text{N}\cdot\text{m}/\text{A})$. Considering the cases of high-velocity movement, we would like the end-point to track a 0.2m -radius circle centered at $(0.8\text{m}, 1.0\text{m})$ in 2 seconds without knowing its precise model. The initial conditions of the link angles and the motor angles are $\mathbf{q} = \boldsymbol{\theta} = [0.0022 \quad 1.5019 \quad 0 \quad 0]^T$. The initial value of the reference model state vector is $\boldsymbol{\tau}_r = [15.97 \quad -47.26 \quad 0 \quad 0]^T$ which is the same as the initial value of the desired reference input $\boldsymbol{\tau}_d$. The initial condition of the motor armature currents is $\mathbf{i} = [77.49 \quad -83.92]^T$ which is the same as the initial value of the desired reference current \mathbf{i}_d . The controller gains are selected as $\mathbf{K}_d = \text{diag}(20, 20)$, $\boldsymbol{\Lambda} = \text{diag}(10, 10)$, and $\mathbf{K}_c = \text{diag}(50, 50)$. Each element of \mathbf{D} , \mathbf{C} , \mathbf{g} , \mathbf{h} , and \mathbf{f} is approximated by the first 11 terms of the Fourier series. The simulation results are shown in Fig. 2 to 9. Fig. 2 shows the tracking performance of the end-point and the desired trajectory in the Cartesian space. It is observed that the end-point trajectory converges nicely to the desired trajectory, although the initial position error is quite large. Fig. 3 is the joint space tracking performance. It shows that the transient response vanishes very quickly. Fig. 4 is the control inputs in voltage. Fig. 5 to 9 are the performance of function approximation for \mathbf{D} , \mathbf{C} , \mathbf{g} , \mathbf{h} , and \mathbf{f} respectively. Since the reference input does not satisfy the persistent excitation condition, some estimates do not converge to their actual values but remain bounded as desired. It is worth to note that in designing the controller we do not need much knowledge for the system. All we have to do is to pick some controller parameters and some initial weighting matrices.

5. Conclusions

An adaptive controller is proposed for RLFJED robots containing time-varying uncertainties. A backstepping-like procedure is developed to deal with the cascade structure in its dynamic equations. The function approximation technique is employed to cope with the time-varying uncertainties. The closed loop stability is proved by using the Lyapunov-like analysis. The realization of the proposed controller does not need to calculate the regressor which is required in most adaptive designs for robot manipulators. Simulation

results justify the performance of the proposed controller in fast tracking operations although most of the robot parameters are not available.

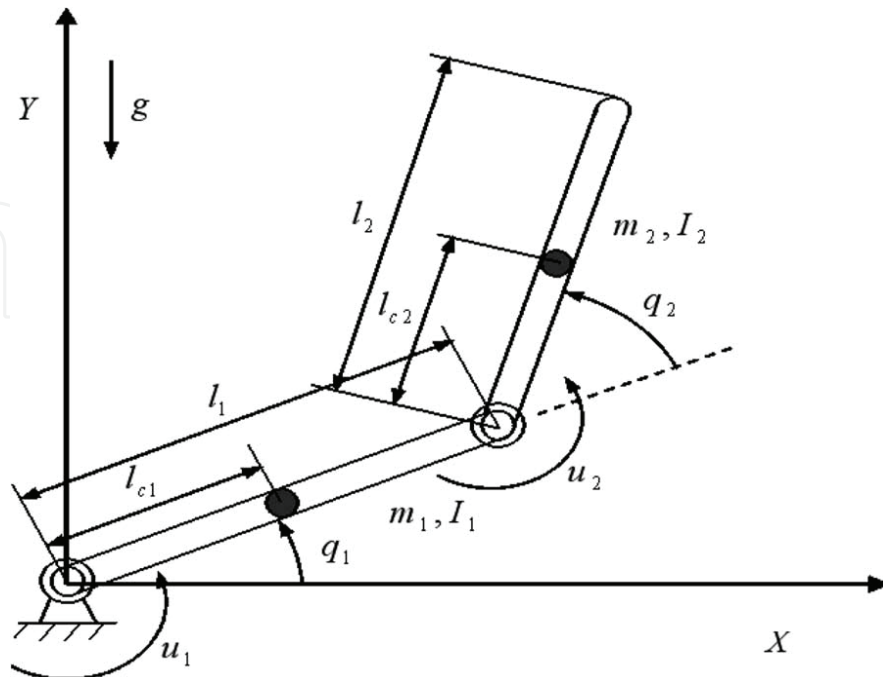

Figure 1. 2-DOF planar robot

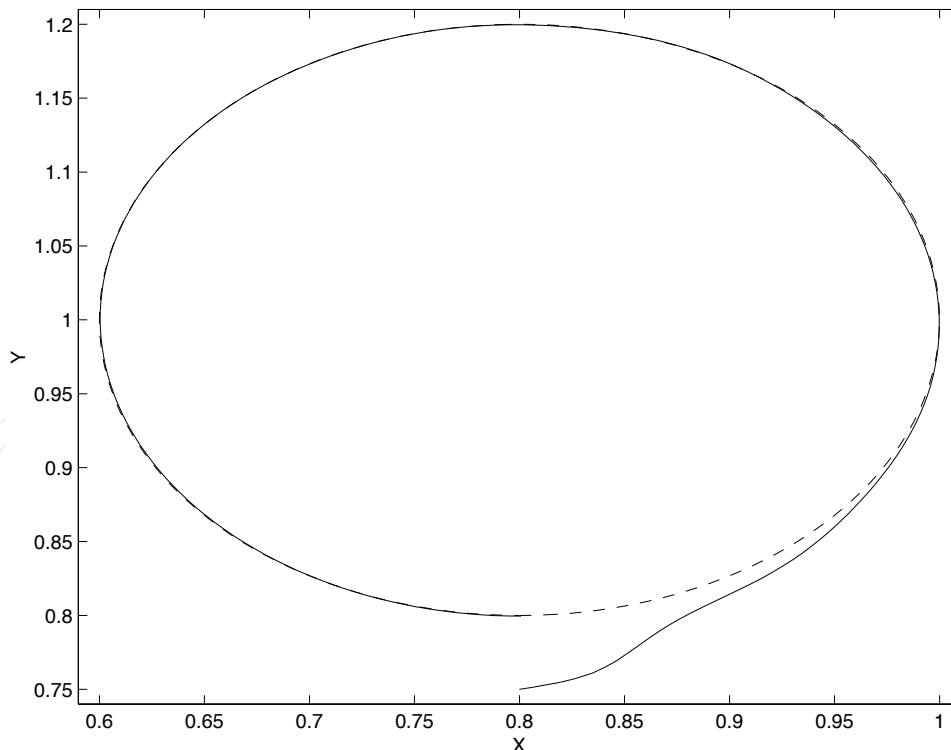

Figure 2. Tracking performance of end-point in the X-Y space (— actual; --- desired). The end-point is initialized at the point $(0.8m, 0.75m)$ and is required to track a $0.2m$ -radius circle in 2 seconds. After some transient, the tracking error is very small, although we do not know precise dynamics of the robot

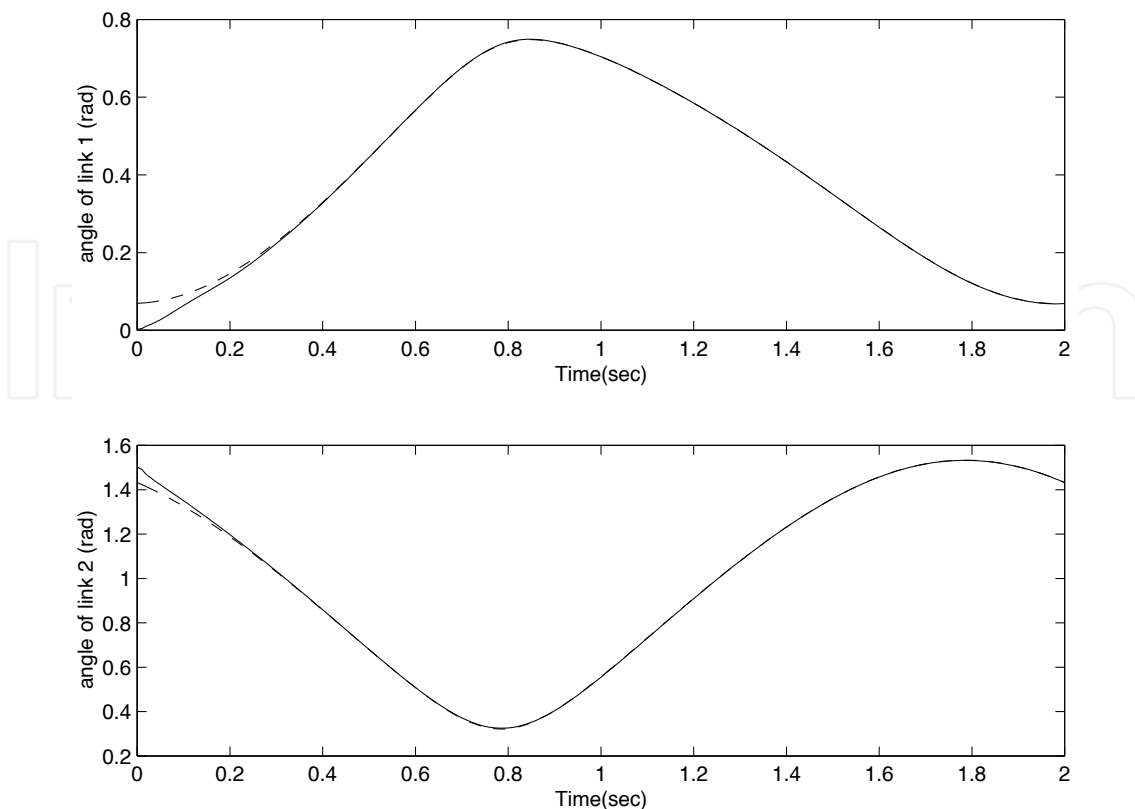

Figure 3. The joint space tracking performance(— actual; --- desired). The real trajectory converges very quickly

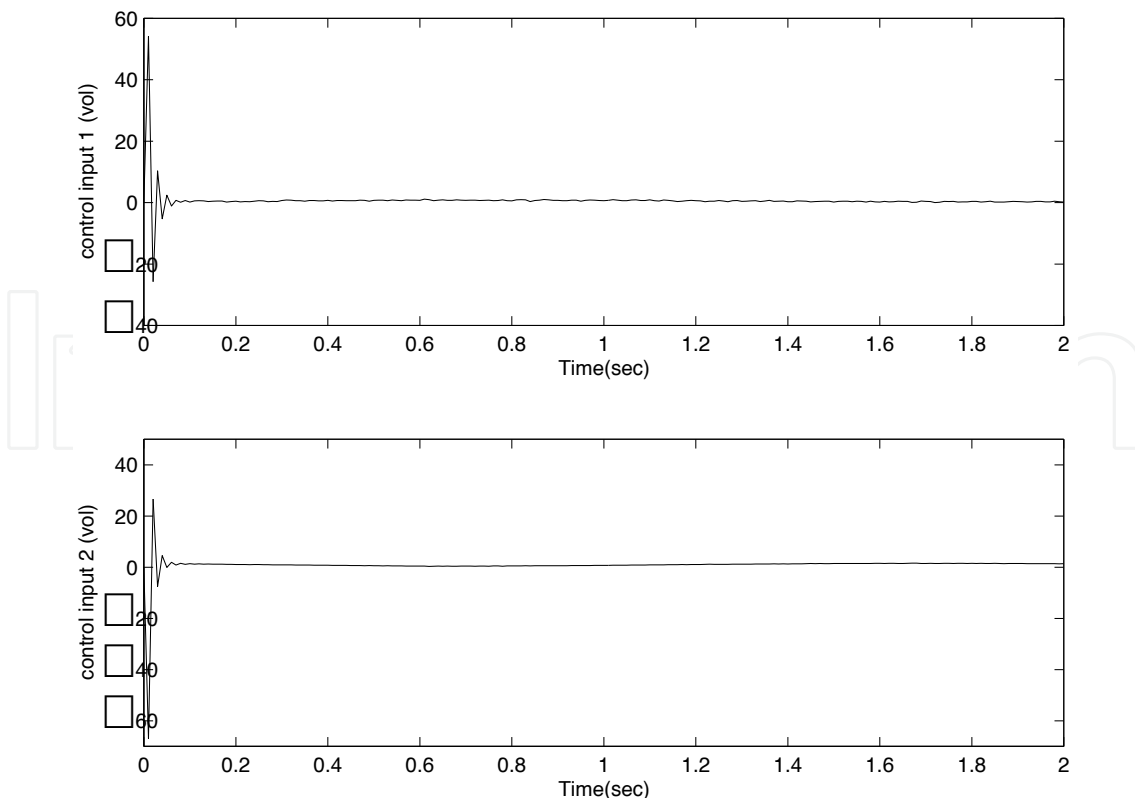

Figure 4. Control input voltage

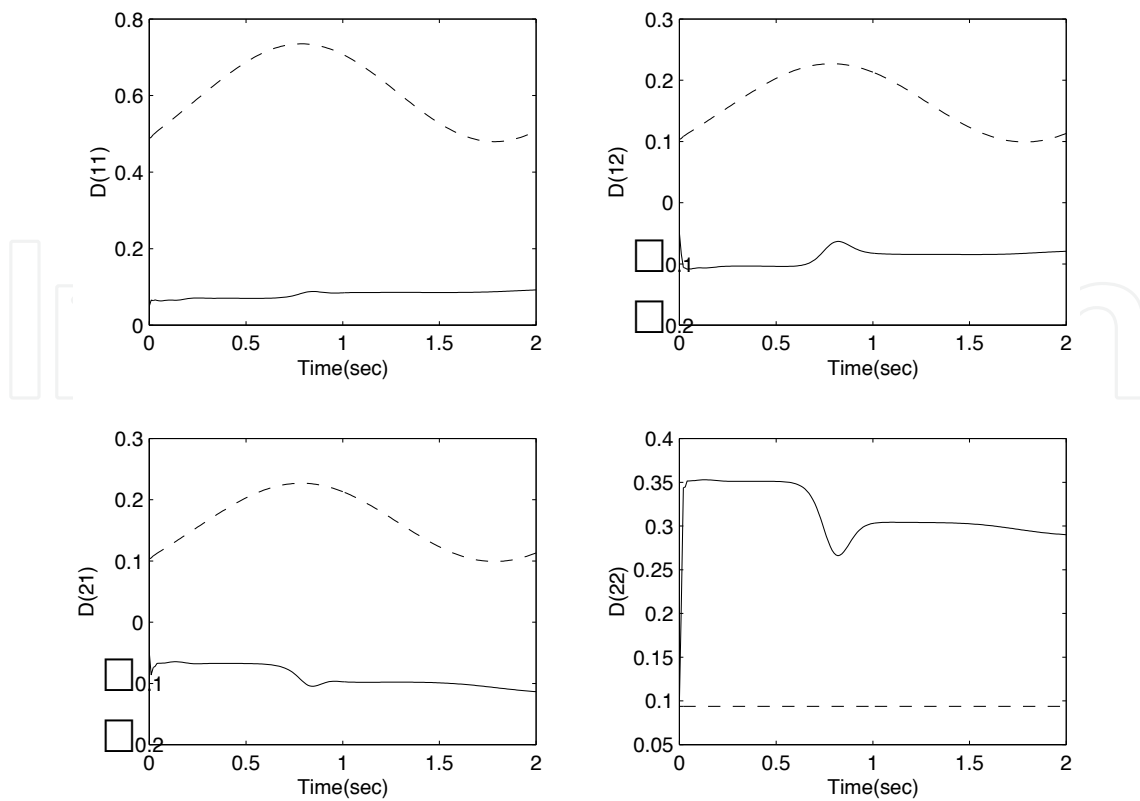

Figure 5. Approximation of D matrix(— estimate; --- real). Although the estimated values do not converge to the true values, they are bounded and small

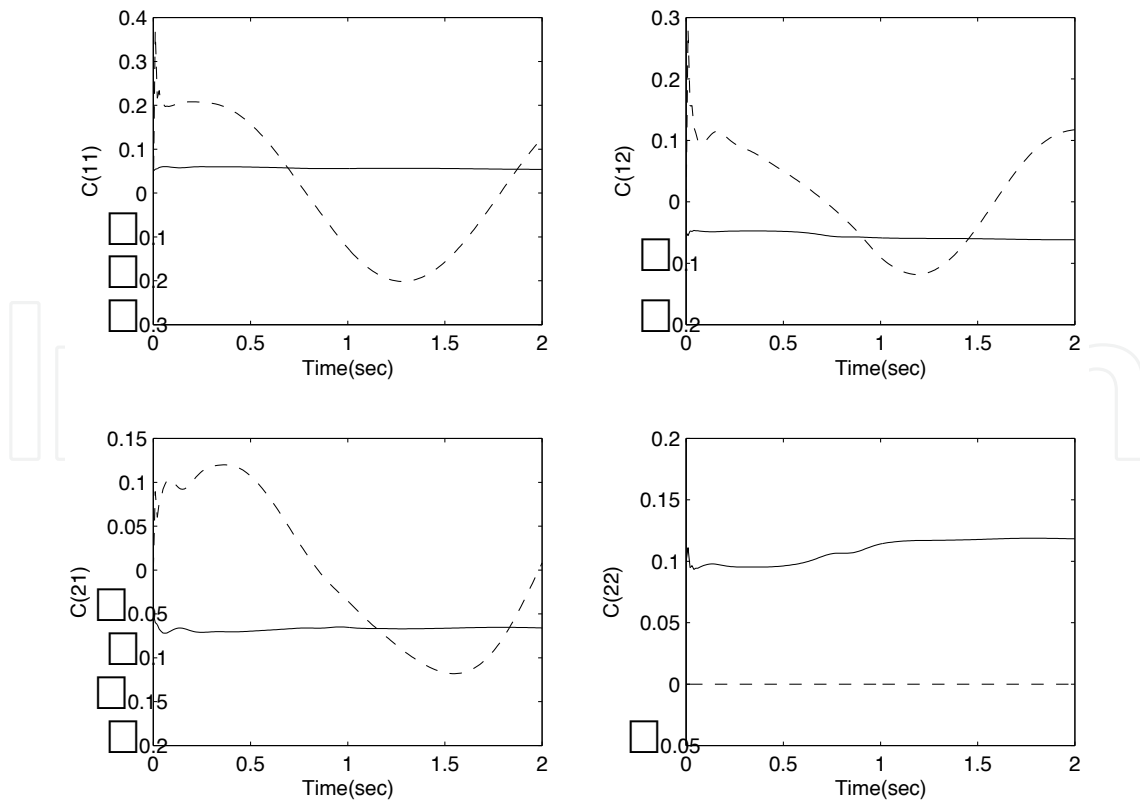

Figure 6. Approximation of C matrix(— estimate; --- real)

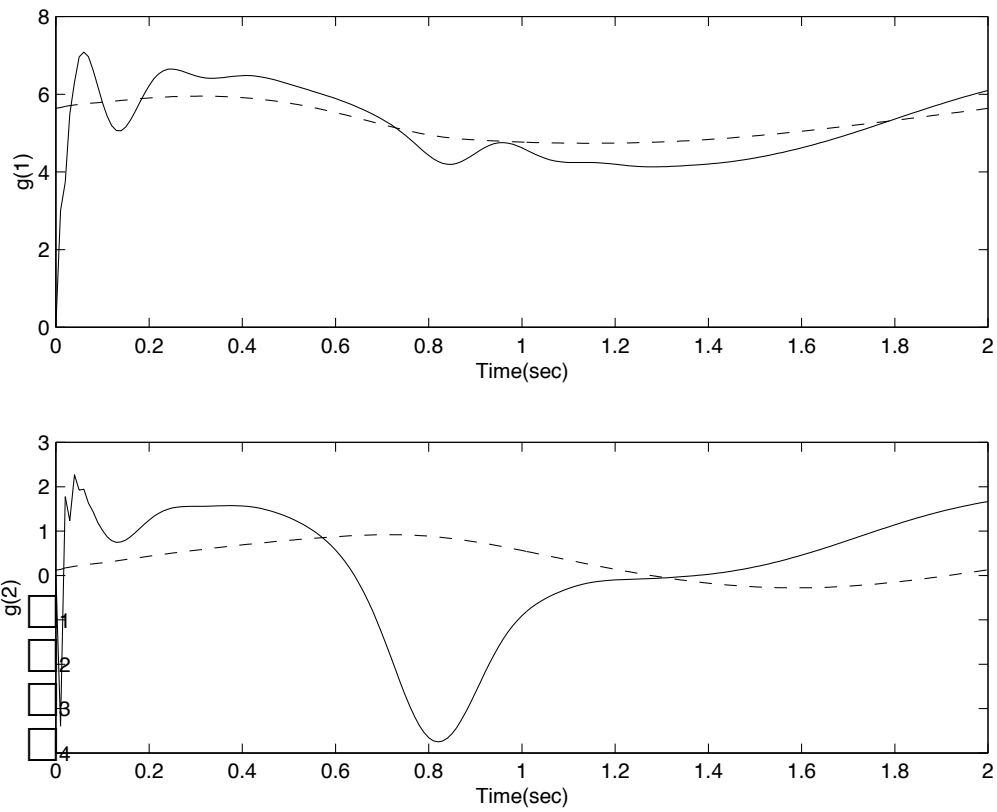

Figure 7. Approximation of vector g (— estimate; --- real)

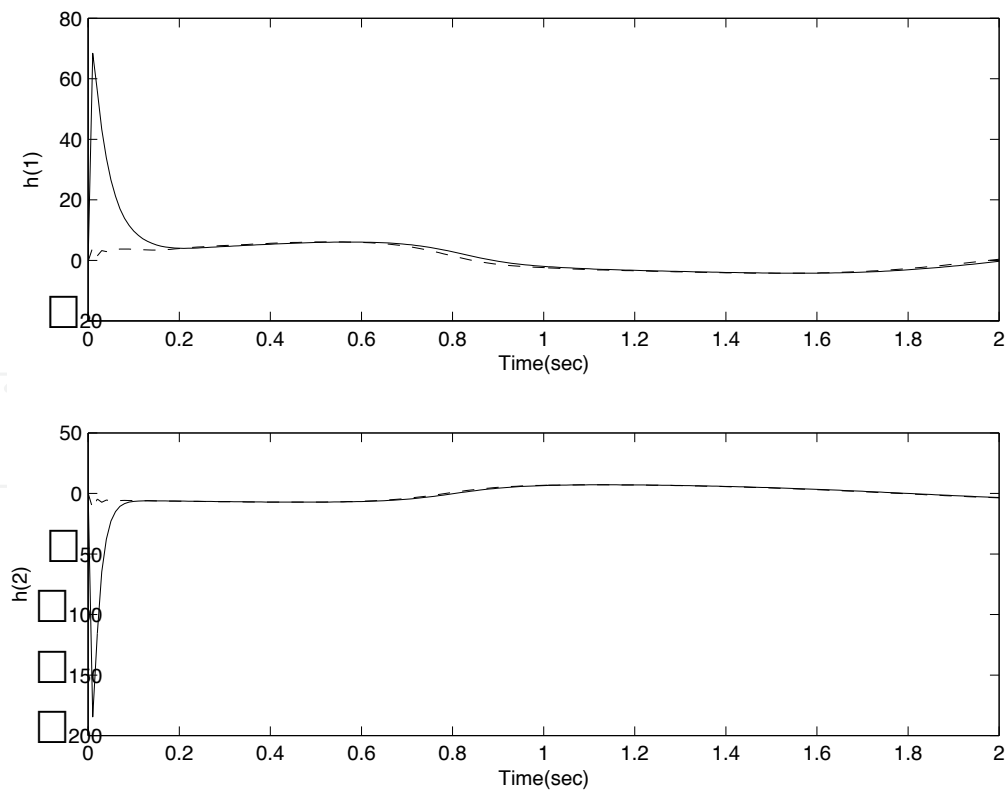

Figure 8. Approximation of vector h (— estimate; --- real)

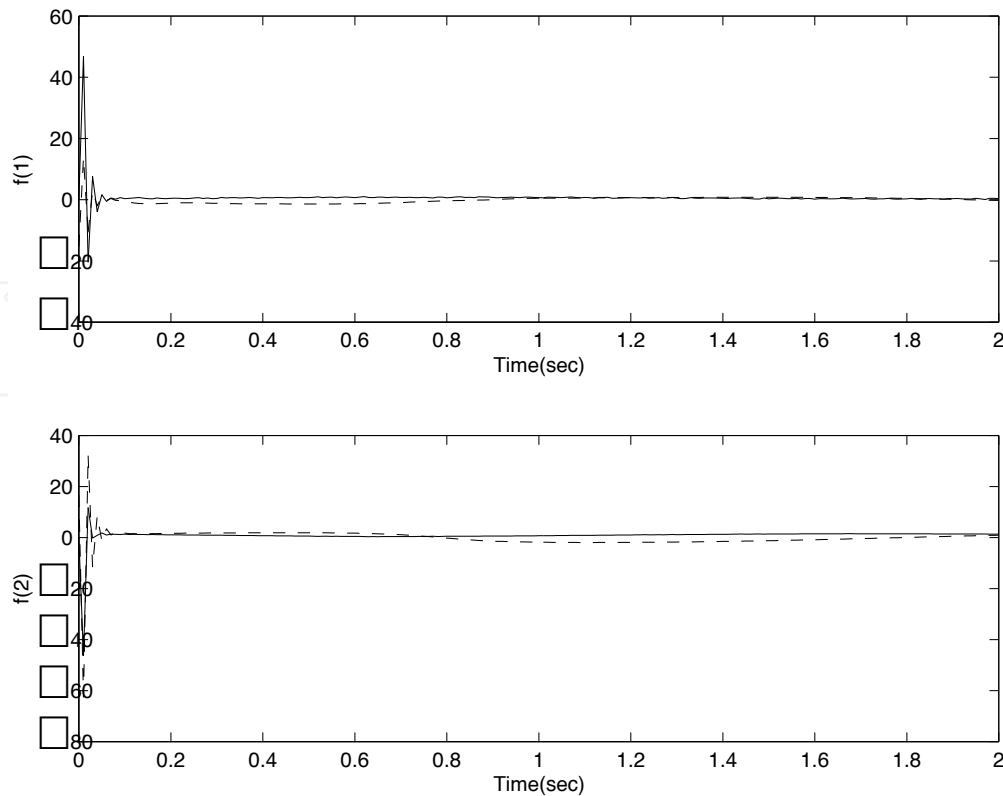

Figure 9. Approximation of vector f (— estimate; --- real)

6. Reference

- M. C. Good, L. M. Sweet, and K. L. Strobel, Dynamic model for control system design of integrated robot and drive systems, *J. Dynamic Systems, Measurement and Control*, vol. 107, no.1, pp. 53-59, 1985. [1]
- T. J. Tarn, A. K. Bejczy, X. Yun and Z. Li, Effect of motor dynamics on nonlinear feedback robot arm control, *IEEE Trans. on Robotics and Automation*, vol. 7, no. 1, pp.114-122, Feb. 1991. [2]
- G. Liu and A. A. Goldenberg, Robust control of robot manipulators incorporating motor dynamics, in *Proc. IEEE/RSJ Int. Conf. on Intelligent Robots and Systems*, Yokohama, Japan, pp.68-75, 1993. [3]
- M. D. Leviner and D. M. Dawson, Hybrid adaptive tracking control of rigid-link electrically driven robots actuated by switched reluctance motors, *System Theory, Proc. SSST '93., Twenty-Fifth Southeastern Symposium*, pp. 53-57, 1993. [4]
- C. Y. Su and Y. Stepanenko, Guaranteed stability based control of robot manipulators incorporating motor dynamics, *IEEE Int. Symposium on Industrial Electronics*, pp. 345-350, 1994. [5]
- C. Kwan, F. L. Lewis, and D. M. Dawson, Robust neural-network control of rigid-link electrically driven robots, *IEEE Trans. on Neural Networks*, vol. 9, no. 4, pp.581-588, July 1998. [6]
- B. S. Chen, H. J. Uang and C. S. Tseng, Robust tracking enhancement of robot systems including motor dynamics: a fuzzy-based dynamics game approach, *IEEE Trans. on Fuzzy Systems*, vol. 6, no. 4, pp. 538-552, Nov. 1998. [7]

- M. Oya, C. Y. Su, and T. Kobayashi, State observer-based robust control scheme for electrically driven robot manipulators, *IEEE Trans. on Robotics*, vol. 20, no. 4, pp. 796-804, Aug. 2004. [8]
- R. J. Wai, C. Y. Tu and P. C. Chen, Robust neural-fuzzy-network control for rigid-link electrically driven robot manipulator, in *The 30th Annual Conf. of the IEEE Industrial Electronics Society*, pp. 1763-1768, Busan, Korea, Nov. 2004. [9]
- J. Hu, D. M. Dawson and Y. Ou, A global adaptive link position tracking controller for robot manipulators driven by induction motors, in *Proc. IEEE Conf. on Decision and Control*, pp.33-38, New Orleans, LA, December, 1995. [10]
- M. M. Bridges and D. M. Dawson, Adaptive control of rigid-link electrically-driven robots actuated with switched reluctance motors, in *Proc. American Control Conf.*, pp. 1392-1396, Seattle, Washington, June, 1995. [11]
- J. Yuan and B. Yuan, A new adaptive robot controller taking account of motor dynamics, in *Proc. American Control Conf.*, pp.1403-1407, 1995. [12]
- H. Yu and S. Lloyd, Adaptive control of robot manipulators including motor dynamics, in *Proc. American Control Conf.*, pp.3803-3807, Seattle, Washington, June, 1995. [13]
- C. Y. Su and Y. Stepanenko, Redesign of Hybrid adaptive/robust motion control of rigid-link electrically-driven robot manipulators, *IEEE Trans. on Robotics and Automation*, vol. 14, no. 4, pp. 651-655, Aug. 1998. [14]
- C. Ishii, T. Shen, and Z. Qu, Lyapunov recursive design of robot adaptive tracking control with L_2 -gain performance for electrically-driven robot manipulators, *Int. J. Control*, vol. 74, no. 8, pp. 811-828, 2001. [15]
- Y. C. Chang, Adaptive tracking control for electrically-driven robots without overparametrization, *Int. J. of Adaptive Control and Signal Processing*, vol. 16, pp. 123-150, 2002. [16]
- G. G. Ramirez and Y. Tang, Adaptive nonlinear control of rigid robots driven by current-fed induction motors, in *Proc. IEEE Conf. on Decision and Control*, pp. 2038-2043, Las Vegas, Nevada, Dec. 2002. [17]
- S. H. Hsu and L. C. Fu, Adaptive decentralized control of robot manipulators driven by current-fed induction motors, *IEEE/ASME Trans. on Mechatronics*, vol. 10, no. 4, pp. 465-468, Aug. 2005. [18]
- A. Ailon, R. Lozano, and M. I. Gil', Point-to-point regulation of a robot with flexible joints including electrical effects of actuator dynamics, *IEEE Trans. on Automatic Control*, vol. 42, no. 4, pp. 559-564, April, 1997. [19]
- A. Ailon, M. I. Gil', E. S. Choi and B. H. Ahn, Stabilizing robots with uncertain parameters actuated by DC motors with flexible coupling shafts, in *Proc. IEEE Int. Conf. on Control Applications*, pp. 877-881, Trieste, Italy, Sept. 1998. [20]
- A. Ailon, M. I. Gil' and E. S. Choi, A simple linear stabilizing controller for a RLED robot with uncertain parameters and some related applications, *Int. J. Control*, vol. 72, no. 6, pp.546-559, 1999. [21]
- A. Ailon, R. Lozano and M. I. Gil', Iterative regulation of an electrically driven flexible-joint robot with model uncertainties, *IEEE Trans. on Robotics and Automation*, vol. 16, no. 6, pp. 863-870, Dec. 2000. [22]
- R. Ortega and M. W. Spong, Adaptive motion control of rigid robots: a tutorial, *Automatica*, vol. 25, pp. 509-519, 1989. [23]

- A. C. Huang and Y. S. Kuo (2001). Sliding control of nonlinear systems containing time-varying uncertainties with unknown bounds, *Int. J. Control*, vol.74, pp.252-264, 2001. [24]
- S. S. Ge, C. C. Hang, T. H. Lee and T. Zang, *Stable Adaptive Neural Network Control*, Boston: Kluwer Academic, 2001. [25]
- J. T. Spooner, M. Maggiore, R. Ordonez and K. M. Passino, *Stable Adaptive Control and Estimation for Nonlinear Systems – Neural and Fuzzy Approximator Techniques*, NY: John Wiley & Sons, 2002 [26]
- M. C. Chien and A. C. Huang, Adaptive impedance control of robot manipulators based on function approximation technique, *Robotica*, vol. 22, pp. 395-403, 2004. [27]
- A. C. Huang and Y. C. Chen, Adaptive multiple-surface sliding control for non-autonomous systems with mismatched uncertainties, *Automatica*, vol. 40, pp. 1939-1945, 2004. [28]
- A. C. Huang and Y. C. Chen (2004). Adaptive sliding control for single-link flexible-joint robot with mismatched uncertainties, *IEEE Trans. on Control Systems Technology*, vol. 12, pp. 770-775, 2004. [29]
- P. C. Chen and A. C. Huang, Adaptive sliding control of non-autonomous active suspension systems with time-vary loadings, *J. of Sound and Vibration*, vol. 282, no. 3-5, pp. 1119-1135, 2005. [30]
- P. C. Chen and A. C. Huang, Adaptive Sliding Control of Active Suspension Systems with Uncertain Hydraulic Actuator Dynamics, *Vehicle System Dynamics*, vol. 44, no. 5, pp.357-368, 2006. [31]
- A. C. Huang, S. C. Wu, and W. F. Ting, An FAT-based Adaptive Controller for Robot Manipulators without Regressor Matrix: Theory and Experiments, *Robotica*, vol. 24, pp. 205-210, 2006. [32]
- A. C. Huang and K. K. Liao, FAT-based Adaptive Sliding Control for Flexible Arms, Theory and Experiments, *Journal of Sound and Vibration*, vol. 298, issue 1-2, pp. 194-205, 2006. [33]
- M. C. Chien and A. C. Huang, Adaptive control of flexible-joint electrically-driven robot with time-varying uncertainties, *IEEE Trans. Industrial Electronics*, vol.54, no.2, pp.1032-1038, 2007. [34]
- M. C. Chien and A. C. Huang, Adaptive Control of Electrically-driven Robot without Computation of Regressor Matrix, *J. Chinese Institute of Engineers*, vol.30, no.5, pp.855-862, 2007. [35]
- M. W. Spong, Modeling and control of elastic joint robots, *ASME J. Dynamic Systems, Measurement, and Control*, vol.109, pp.310-319, 1987. [36]
- T. Lin and A. A. Goldenberg, Robust adaptive control of flexible joint robots with joint torque feedback, in *Proc. IEEE Conf. Robotics and Automation*, pp.1229-1234, 1995. [37]
- K. S. Narendra and A. M. Annaswamy, *Stable Adaptive System*, Prentice Hall, 1989. [38]
- J-J. E. Slotine and W. Li, *Applied Nonlinear Control*, Prentice Hall, NJ, 1991. [39]
- Khalil, H.K., *Nonlinear Systems*, Prentice-Hall, New Jersey, 2002. [40]

7. Appendix

Lemma A.1:

Let $\mathbf{s} \in \mathfrak{R}^n$, $\boldsymbol{\varepsilon} \in \mathfrak{R}^n$ and \mathbf{K} is the $n \times n$ positive definite matrix. Then,

$$-\mathbf{s}^T \mathbf{K} \mathbf{s} + \mathbf{s}^T \boldsymbol{\varepsilon} \leq \frac{1}{2} [\lambda_{\min}(\mathbf{K}) \|\mathbf{s}\|^2 - \frac{\|\boldsymbol{\varepsilon}\|^2}{\lambda_{\min}(\mathbf{K})}]. \quad (\text{A.1})$$

Proof:

$$\begin{aligned} -\mathbf{s}^T \mathbf{K} \mathbf{s} + \mathbf{s}^T \boldsymbol{\varepsilon} &\leq [-\lambda_{\min}(\mathbf{K}) \|\mathbf{s}\| + \|\boldsymbol{\varepsilon}\|] \|\mathbf{s}\| \\ &= -\frac{1}{2} \left[\sqrt{\lambda_{\min}(\mathbf{K})} \|\mathbf{s}\| - \frac{\|\boldsymbol{\varepsilon}\|}{\sqrt{\lambda_{\min}(\mathbf{K})}} \right]^2 \\ &\quad - \frac{1}{2} \left[\lambda_{\min}(\mathbf{K}) \|\mathbf{s}\|^2 - \frac{\|\boldsymbol{\varepsilon}\|^2}{\lambda_{\min}(\mathbf{K})} \right] \\ &\leq -\frac{1}{2} \left[\lambda_{\min}(\mathbf{K}) \|\mathbf{s}\|^2 - \frac{\|\boldsymbol{\varepsilon}\|^2}{\lambda_{\min}(\mathbf{K})} \right] \end{aligned}$$

Q.E.D.

Lemma A.2:

Let $\mathbf{w}_i^T = [w_{i1} \ w_{i2} \ \cdots \ w_{in}] \in \mathfrak{R}^{1 \times n}$, $i=1, \dots, m$ and \mathbf{W} is a block diagonal matrix defined as $\mathbf{W} = \text{diag}\{\mathbf{w}_1, \mathbf{w}_2, \dots, \mathbf{w}_m\} \in \mathfrak{R}^{m \times m}$. Then,

$$\text{Tr}(\mathbf{W}^T \mathbf{W}) = \sum_{i=1}^m \|\mathbf{w}_i\|^2. \quad (\text{A.2})$$

The notation $\text{Tr}(\cdot)$ denotes the trace operation.

Proof: The proof is straightforward as below:

$$\begin{aligned}
 \mathbf{W}^T \mathbf{W} &= \begin{bmatrix} w_{11} & \cdots & w_{1n} & 0 & \cdots & 0 & \cdots & 0 & \cdots & 0 \\ 0 & \cdots & 0 & w_{21} & \cdots & w_{2n} & \cdots & 0 & \cdots & 0 \\ \vdots & \ddots & \vdots & \vdots & \ddots & \vdots & \ddots & \vdots & \ddots & \vdots \\ 0 & \cdots & 0 & 0 & \cdots & 0 & \cdots & w_{m1} & \cdots & w_{mn} \end{bmatrix} \begin{bmatrix} w_{11} & 0 & \cdots & 0 \\ \vdots & \vdots & \ddots & \vdots \\ w_{1n} & 0 & \cdots & 0 \\ 0 & w_{21} & \cdots & 0 \\ \vdots & \vdots & \ddots & \vdots \\ 0 & w_{2n} & \cdots & 0 \\ \vdots & \vdots & \ddots & \vdots \\ 0 & 0 & \cdots & w_{m1} \\ \vdots & \vdots & \ddots & \vdots \\ 0 & 0 & \cdots & w_{mn} \end{bmatrix} \\
 &= \begin{bmatrix} \mathbf{w}_1^T & \mathbf{0} & \cdots & \mathbf{0} \\ \mathbf{0} & \mathbf{w}_2^T & \cdots & \mathbf{0} \\ \vdots & \vdots & \ddots & \vdots \\ \mathbf{0} & \mathbf{0} & \cdots & \mathbf{w}_m^T \end{bmatrix} \begin{bmatrix} \mathbf{w}_1 & \mathbf{0} & \cdots & \mathbf{0} \\ \mathbf{0} & \mathbf{w}_2 & \cdots & \mathbf{0} \\ \vdots & \vdots & \ddots & \vdots \\ \mathbf{0} & \mathbf{0} & \cdots & \mathbf{w}_m \end{bmatrix} \\
 &= \begin{bmatrix} \mathbf{w}_1^T \mathbf{w}_1 & \mathbf{0} & \cdots & \mathbf{0} \\ \mathbf{0} & \mathbf{w}_2^T \mathbf{w}_2 & \cdots & \mathbf{0} \\ \vdots & \vdots & \ddots & \vdots \\ \mathbf{0} & \mathbf{0} & \cdots & \mathbf{w}_m^T \mathbf{w}_m \end{bmatrix} \\
 &= \begin{bmatrix} \|\mathbf{w}_1\|^2 & \mathbf{0} & \cdots & \mathbf{0} \\ \mathbf{0} & \|\mathbf{w}_2\|^2 & \cdots & \mathbf{0} \\ \vdots & \vdots & \ddots & \vdots \\ \mathbf{0} & \mathbf{0} & \cdots & \|\mathbf{w}_m\|^2 \end{bmatrix}
 \end{aligned}$$

The last equality holds because by definition $\mathbf{w}_i^T \mathbf{w}_i = w_{i1}^2 + w_{i2}^2 + \dots + w_{in}^2 = \|\mathbf{w}_i\|^2$.

Therefore, we have $Tr = (\mathbf{W}^T \mathbf{W}) = \sum_{i=1}^m \|\mathbf{w}_i\|^2$. Q.E.D.

Lemma A.3:

Suppose $\mathbf{w}_i^T = [w_{i1} \ w_{i2} \ \cdots \ w_{in}] \in \mathcal{R}^{1 \times n}$ and $\mathbf{v}_i^T = [v_{i1} \ v_{i2} \ \cdots \ v_{in}] \in \mathcal{R}^{1 \times n}$, $i=1, \dots, m$. Let \mathbf{W} and \mathbf{V} be block diagonal matrices that are defined as $\mathbf{W} = \text{diag}\{\mathbf{w}_1, \mathbf{w}_2, \dots, \mathbf{w}_m\} \in \mathcal{R}^{m \times n}$ and $\mathbf{V} = \text{diag}\{\mathbf{v}_1, \mathbf{v}_2, \dots, \mathbf{v}_m\} \in \mathcal{R}^{m \times m}$, respectively. Then,

$$Tr(\mathbf{V}^T \mathbf{W}) \leq \sum_{i=1}^m \|\mathbf{v}_i\| \|\mathbf{w}_i\| \quad . (A.3)$$

Proof: The proof is also straightforward:

$$\begin{aligned} \mathbf{V}^T \mathbf{W} &= \begin{bmatrix} \mathbf{v}_1^T & \mathbf{0} & \cdots & \mathbf{0} \\ \mathbf{0} & \mathbf{v}_2^T & \cdots & \mathbf{0} \\ \vdots & \vdots & \ddots & \vdots \\ \mathbf{0} & \mathbf{0} & \cdots & \mathbf{v}_m^T \end{bmatrix} \begin{bmatrix} \mathbf{w}_1 & \mathbf{0} & \cdots & \mathbf{0} \\ \mathbf{0} & \mathbf{w}_2 & \cdots & \mathbf{0} \\ \vdots & \vdots & \ddots & \vdots \\ \mathbf{0} & \mathbf{0} & \cdots & \mathbf{w}_m \end{bmatrix} \\ &= \begin{bmatrix} \mathbf{v}_1^T \mathbf{w}_1 & \mathbf{0} & \cdots & \mathbf{0} \\ \mathbf{0} & \mathbf{v}_2^T \mathbf{w}_2 & \cdots & \mathbf{0} \\ \vdots & \vdots & \ddots & \vdots \\ \mathbf{0} & \mathbf{0} & \cdots & \mathbf{v}_m^T \mathbf{w}_m \end{bmatrix} \end{aligned}$$

Hence,

$$\begin{aligned} Tr(\mathbf{V}^T \mathbf{W}) &= \mathbf{v}_1^T \mathbf{w}_1 + \mathbf{v}_2^T \mathbf{w}_2 + \dots + \mathbf{v}_m^T \mathbf{w}_m \\ &\leq \|\mathbf{v}_1\| \|\mathbf{w}_1\| + \|\mathbf{v}_2\| \|\mathbf{w}_2\| + \dots + \|\mathbf{v}_m\| \|\mathbf{w}_m\| \quad \text{Q.E.D.} \\ &= \sum_{i=1}^m \|\mathbf{v}_i\| \|\mathbf{w}_i\| \end{aligned}$$

Lemma A.4:

Let \mathbf{W} be defined as in *Lemma A.2*, and $\tilde{\mathbf{W}}$ is a matrix defined as $\tilde{\mathbf{W}} = \mathbf{W} - \hat{\mathbf{W}}$, where $\hat{\mathbf{W}}$ is a matrix with proper dimension. Then

$$Tr(\tilde{\mathbf{W}}^T \hat{\mathbf{W}}) \leq \frac{1}{2} Tr(\mathbf{W}^T \mathbf{W}) - \frac{1}{2} Tr(\tilde{\mathbf{W}}^T \tilde{\mathbf{W}}). \quad (A.4)$$

Proof:

$$\begin{aligned}
Tr(\tilde{\mathbf{W}}^T \hat{\mathbf{W}}) &= Tr(\tilde{\mathbf{W}}^T \mathbf{W}) - Tr(\tilde{\mathbf{W}}^T \tilde{\mathbf{W}}) \\
&\leq \sum_{i=1}^m (\|\tilde{\mathbf{w}}_i\| \|\mathbf{w}_i\| - \|\tilde{\mathbf{w}}_i\|^2) \quad (\text{by Lemma A.2 and A.3}) \\
&= \frac{1}{2} \sum_{i=1}^m [\|\mathbf{w}_i\|^2 - \|\tilde{\mathbf{w}}_i\|^2 - (\|\tilde{\mathbf{w}}_i\| - \|\mathbf{w}_i\|)^2] \\
&\leq \frac{1}{2} \sum_{i=1}^m (\|\mathbf{w}_i\|^2 - \|\tilde{\mathbf{w}}_i\|^2) \\
&= \frac{1}{2} Tr(\mathbf{W}^T \mathbf{W}) - \frac{1}{2} Tr(\tilde{\mathbf{W}}^T \tilde{\mathbf{W}}) \quad (\text{by Lemma A.2})
\end{aligned}$$

Q.E.D.

In the above lemmas, we consider properties of a block diagonal matrix. In the following, we would like to extend the analysis to a class of more general matrices.

Lemma A.5:

Let \mathbf{W} be a matrix in the form $\mathbf{W}^T = [\mathbf{W}_1^T \quad \mathbf{W}_2^T \quad \cdots \quad \mathbf{W}_p^T] \in \mathfrak{R}^{pmn \times m}$ where $\mathbf{W}_i = \text{diag}\{\mathbf{w}_{i1}, \mathbf{w}_{i2}, \dots, \mathbf{w}_{im}\} \in \mathfrak{R}^{mn \times m}$, $i=1, \dots, p$, are block diagonal matrices with the entries of vectors $\mathbf{w}_{ij}^T = [w_{ij1} \quad w_{ij2} \quad \cdots \quad w_{ijn}] \in \mathfrak{R}^{1 \times n}$, $j=1, \dots, m$. Then, we may have

$$Tr(\mathbf{W}^T \mathbf{W}) = \sum_{i=1}^p \sum_{j=1}^m \|\mathbf{w}_{ij}\|^2. \quad (\text{A.5})$$

Proof:

$$\begin{aligned}
\mathbf{W}^T \mathbf{W} &= [\mathbf{W}_1^T \quad \cdots \quad \mathbf{W}_p^T] \begin{bmatrix} \mathbf{W}_1 \\ \vdots \\ \mathbf{W}_p \end{bmatrix} \\
&= \mathbf{W}_1^T \mathbf{W}_1 + \cdots + \mathbf{W}_p^T \mathbf{W}_p
\end{aligned}$$

Hence, we may calculate the trace as

$$\begin{aligned} Tr(\mathbf{W}^T \mathbf{W}) &= Tr(\mathbf{W}_1^T \mathbf{W}_1) + \dots + Tr(\mathbf{W}_p^T \mathbf{W}_p) \\ &= \sum_{j=1}^m \|\mathbf{w}_{1j}\|^2 + \dots + \sum_{j=1}^m \|\mathbf{w}_{pj}\|^2 \quad (\text{by Lemma A.1}) \\ &= \sum_{i=1}^p \sum_{j=1}^m \|\mathbf{w}_{ij}\|^2 \end{aligned}$$

Q.E.D.

Lemma A.6:

Let \mathbf{V} and \mathbf{W} be matrices defined in Lemma A.5, Then, $Tr(\mathbf{V}^T \mathbf{W}) \leq \sum_{i=1}^p \sum_{j=1}^m \|\mathbf{v}_{ij}\| \|\mathbf{w}_{ij}\|$.

(A.6)

Proof:

$$\begin{aligned} Tr(\mathbf{V}^T \mathbf{W}) &= Tr(\mathbf{V}_1^T \mathbf{W}_1) + \dots + Tr(\mathbf{V}_p^T \mathbf{W}_p) \\ &\leq \sum_{j=1}^m \|\mathbf{v}_{1j}\| \|\mathbf{w}_{1j}\| + \dots + \sum_{j=1}^m \|\mathbf{v}_{pj}\| \|\mathbf{w}_{pj}\| \quad (\text{by Lemma A.3}) \\ &= \sum_{i=1}^p \sum_{j=1}^m \|\mathbf{v}_{ij}\| \|\mathbf{w}_{ij}\| \end{aligned}$$

Q.E.D.

Lemma A.7:

Let \mathbf{W} be defined as in Lemma A.5, and $\tilde{\mathbf{W}}$ is a matrix defined as $\tilde{\mathbf{W}} = \mathbf{W} - \hat{\mathbf{W}}$, where $\hat{\mathbf{W}}$ is a matrix with proper dimension. Then

$$Tr(\tilde{\mathbf{W}}^T \hat{\mathbf{W}}) \leq \frac{1}{2} Tr(\mathbf{W}^T \mathbf{W}) - \frac{1}{2} Tr(\tilde{\mathbf{W}}^T \tilde{\mathbf{W}}). \quad (\text{A.7})$$

Proof:

$$\begin{aligned}
 \text{Tr}(\tilde{\mathbf{W}}^T \hat{\mathbf{W}}) &= \text{Tr}(\tilde{\mathbf{W}}^T \mathbf{W}) - \text{Tr}(\tilde{\mathbf{W}}^T \tilde{\mathbf{W}}) \\
 &\leq \sum_{i=1}^p \sum_{j=1}^m (\|\tilde{\mathbf{w}}_{ij}\| \|\mathbf{w}_{ij}\| - \|\tilde{\mathbf{w}}_{ij}\|^2) \quad (\text{by Lemma A.5 and A.6}) \\
 &= \frac{1}{2} \sum_{i=1}^p \sum_{j=1}^m [\|\mathbf{w}_{ij}\|^2 - \|\tilde{\mathbf{w}}_{ij}\|^2 - (\|\tilde{\mathbf{w}}_{ij}\| - \|\mathbf{w}_{ij}\|)^2] \\
 &\leq \frac{1}{2} \sum_{i=1}^p \sum_{j=1}^m (\|\mathbf{w}_{ij}\|^2 - \|\tilde{\mathbf{w}}_{ij}\|^2) \\
 &= \frac{1}{2} \text{Tr}(\mathbf{W}^T \mathbf{W}) - \frac{1}{2} \text{Tr}(\tilde{\mathbf{W}}^T \tilde{\mathbf{W}}) \quad (\text{by Lemma A.5})
 \end{aligned}$$

Q.E.D



Frontiers in Adaptive Control

Edited by Shuang Cong

ISBN 978-953-7619-43-5

Hard cover, 334 pages

Publisher InTech

Published online 01, January, 2009

Published in print edition January, 2009

The objective of this book is to provide an up-to-date and state-of-the-art coverage of diverse aspects related to adaptive control theory, methodologies and applications. These include various robust techniques, performance enhancement techniques, techniques with less a-priori knowledge, nonlinear adaptive control techniques and intelligent adaptive techniques. There are several themes in this book which instance both the maturity and the novelty of the general adaptive control. Each chapter is introduced by a brief preamble providing the background and objectives of subject matter. The experiment results are presented in considerable detail in order to facilitate the comprehension of the theoretical development, as well as to increase sensitivity of applications in practical problems

How to reference

In order to correctly reference this scholarly work, feel free to copy and paste the following:

Ming-Chih Chien and An-Chyau Huang (2009). An Adaptive Controller Design for Flexible-joint Electrically-driven Robots With Consideration of Time-Varying Uncertainties, *Frontiers in Adaptive Control*, Shuang Cong (Ed.), ISBN: 978-953-7619-43-5, InTech, Available from:

http://www.intechopen.com/books/frontiers_in_adaptive_control/an_adaptive_controller_design_for_flexible-joint_electrically-driven_robots_with_consideration_of_ti

INTECH
open science | open minds

InTech Europe

University Campus STeP Ri
Slavka Krautzeka 83/A
51000 Rijeka, Croatia
Phone: +385 (51) 770 447
Fax: +385 (51) 686 166
www.intechopen.com

InTech China

Unit 405, Office Block, Hotel Equatorial Shanghai
No.65, Yan An Road (West), Shanghai, 200040, China
中国上海市延安西路65号上海国际贵都大饭店办公楼405单元
Phone: +86-21-62489820
Fax: +86-21-62489821

© 2009 The Author(s). Licensee IntechOpen. This chapter is distributed under the terms of the [Creative Commons Attribution-NonCommercial-ShareAlike-3.0 License](#), which permits use, distribution and reproduction for non-commercial purposes, provided the original is properly cited and derivative works building on this content are distributed under the same license.

IntechOpen

IntechOpen