

We are IntechOpen, the world's leading publisher of Open Access books Built by scientists, for scientists

5,300

Open access books available

132,000

International authors and editors

160M

Downloads

Our authors are among the

154

Countries delivered to

TOP 1%

most cited scientists

12.2%

Contributors from top 500 universities



WEB OF SCIENCE™

Selection of our books indexed in the Book Citation Index
in Web of Science™ Core Collection (BKCI)

Interested in publishing with us?
Contact book.department@intechopen.com

Numbers displayed above are based on latest data collected.
For more information visit www.intechopen.com



Energy Measurement Techniques for Energy Efficiency Programs

Luís F. C. Duarte, Elnatan C. Ferreira and José A. Siqueira Dias

Additional information is available at the end of the chapter

<http://dx.doi.org/10.5772/47791>

1. Introduction

The reduction of energy consumption and elimination of energy waste are among the main goals of all countries that recognize that the world climate is changing due to these problems. Reducing greenhouse gas (GHG) emissions is mandatory for preserving a healthy biosphere and all earth's ecological systems.

The main source of greenhouse gases originated by human activities is the burning of fossil fuels [21]. Studies show how it is possible to generate electricity from renewable energy sources other than burning fossil fuel. Unfortunately, those technologies are not yet widely spread or haven't reached a development stage where the production costs are adequate for the economic scenarios [18, 20, 23].

BP Statistical Review of World Energy 2009 [3] showed that in 2008, the total worldwide energy consumption was 474 exajoules (474×10^{18} J), with 80 to 90 % derived from the combustion of fossil fuels. If this scenario does not change, it can lead us to an unpleasant future with several environmental issues, from global warming caused by fossil fuel combustion and deforestation due to acid rain and destruction of the ozone layer.

In order to change this scenario, utilities and governmental agencies all over the world are implementing energy efficiency programs. These programs are designed to implement solutions which help customers to manage the energy use and save money on energy bills. However, the first step in achieving an energy-efficient houses is the understanding of where the energy is going. It has been shown that the effectiveness of an energy efficiency program depends strongly on the feedback that the consumers receive about their energy use.

A good knowledge of where the energy is going is fundamental for the customers to decide how it is possible to reduce energy waste and maximize energy bill savings. There are different approaches for implementing energy efficiency programs, and basically two types of actions that can be taken: by changing the behavior and habits of the customers in what concerns the use of home appliances or by making investments in energy-efficient technologies. Many

times, in order to achieve a significant improvement in energy savings, these two actions must be implemented simultaneously.

Some programs provide direct payments or subsidies (rebates, discounts and loans) to customers who decide to purchase or install a specific energy efficiency home appliance. Other programs address non-financial incentives such as information and technical services. Non-financial incentives/services may be bundled with direct or indirect incentives, or may be offered on a stand-alone basis. Depending on the customer type and market characteristics that a given program targets, an effective energy efficiency program design may include any one of these incentive types, or may bundle them together in various ways [17].

It has been shown that the reduction of energy consumption by customers or the adequacy of their consumption behavior is strongly related with the quality of feedback on where (and what for) the energy spent was used. This understanding leads to changes in behavior that can both reduce energy consumption and shift the energy use from peak periods to off-peak periods. The more detailed is the feedback information that the customer receives, the more efficient and substantial are the energy savings.

The results from surveys conducted by the American Council for an Energy-Efficient Economy in [8] are shown in Figure 1, where it can be noticed that Real-Time Plus Feedback (real-time information down to the appliance level) offered to households can provide energy savings of up to 12%.

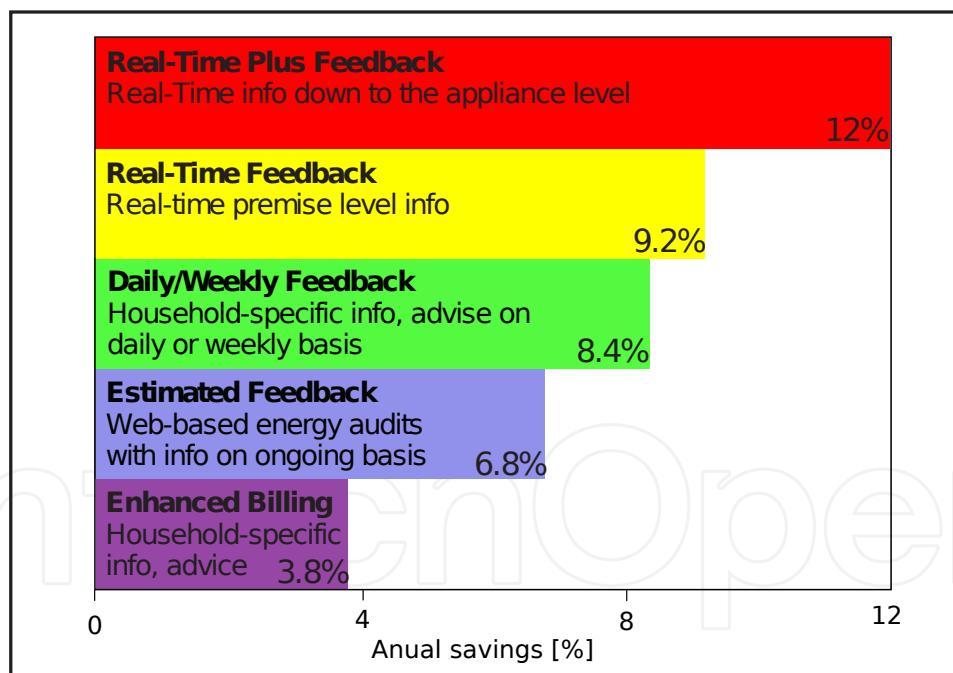

Figure 1. Average household electricity savings, based on 36 studies carried out between 1995-2010

It has been observed that technical and physical improvements in housing are not enough to guarantee reduced energy consumption since consumption in identical homes can easily differ by a factor of two or more depending on the behavior of the inhabitants. Thus, smart metering (or advanced metering) was proposed as a promising way of developing the energy market and contributing to social, environmental and security-of-supply objectives [4] because this technology allows households to have a feedback on the energy consumption

of each home appliance, contributing to the knowledge of the relative demand of different appliances and also showing bad habits of the inhabitants.

This chapter will present and discuss several energy measurement methods and technologies of advanced metering initiatives (AMI) for in-house use (devices which are installed after the electric panel) which can be used to distinguish the power consumption of each electrical appliance in a building and provide a detailed breakdown of the energy bill.

2. Electrical energy measurement basics

Power is, by definition, a work done per unit time. Measured in Watts (W), electrical power is commonly acquired indirectly, by measuring the voltage and the current of the circuit. In alternating current (AC) circuits, instantaneous electrical power is calculated by multiplying the instantaneous values of the voltage and current:

$$P_i = V_i \times I_i \quad (1)$$

Electrical energy is obtained by accumulating instantaneous electrical power measurements over a period of time, and is written as:

$$E = \int_0^t V(t) \times I(t) dt \quad (2)$$

In energy meters integrated circuits, the signals of voltage and current are discretized in time by an analog to digital converter (ADC), and the electrical energy is then written as:

$$E = \sum_{i=0}^{i=T} V_i \times I_i \quad (3)$$

In the energy meters integrated circuits (ICs) the voltage is usually obtained using a resistive voltage divider connected directly to the ac line, and the current can be acquired by measuring the voltage drop across a shunt resistor or across a burden resistor connected to a current transformer.

Figure 2 shows the basic schematic diagram of an electrical energy meter IC. A current transformer with a burden resistor is used to provide the current-to-voltage conversion needed by the current channel ADC, and a simple resistive divider network attenuates the line voltage which will be fed into the voltage input channel ADC.

In order to achieve high accuracy, modern electrical energy metering ICs perform the signal processing, such as multiplication and filtering, in the digital domain. This approach provides superior stability and accuracy over time even in extreme environmental conditions. Their operation is based on high precision Sigma-Delta Analog to Digital Converters with resolution between 16 - 24 bits, and signal data processing integrated in hardware level.

To achieve high resolution and reduce noise, the Sigma-Delta Analog to Digital Converters in the IC convert the signals from the current and voltage channels using oversampling. The signals are sampled at a frequency that is many times higher than the bandwidth of interest and this spreads the quantization noise over a wider bandwidth. With the noise spread over a wider bandwidth, the quantization noise within the band of interest is lowered [2].

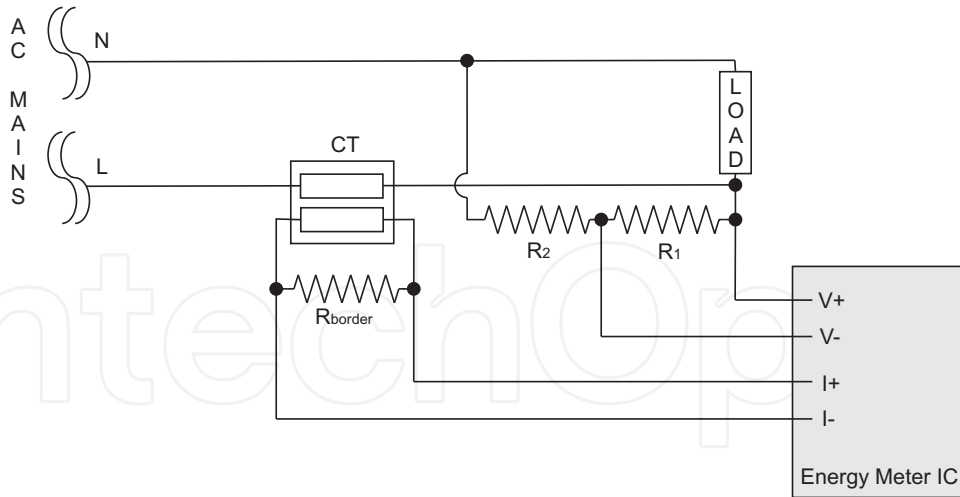

Figure 2. Energy meter IC connected to a resistive voltage divider and current transformer with burden resistor.

This analog input structure greatly simplifies sensor interfacing by providing a wide dynamic range for direct connection to the sensor and also simplifies the antialiasing filter design. A high-pass filter in the current channel removes any dc component from the current signal, eliminating inaccuracies in the real power calculation which may appear due to offsets in the voltage or current signals [1].

The real power calculation is derived from the instantaneous power signal, which is generated by a direct multiplication of the current and voltage signals. To extract the real power component (that is, the DC component), the instantaneous power signal is low-pass filtered. Figure 3 presents a graph of the instantaneous real power signal and shows how the real power information is extracted by low-pass filtering of the instantaneous power signal. This scheme calculates real power for sinusoidal current and voltage waveforms at all power factors.

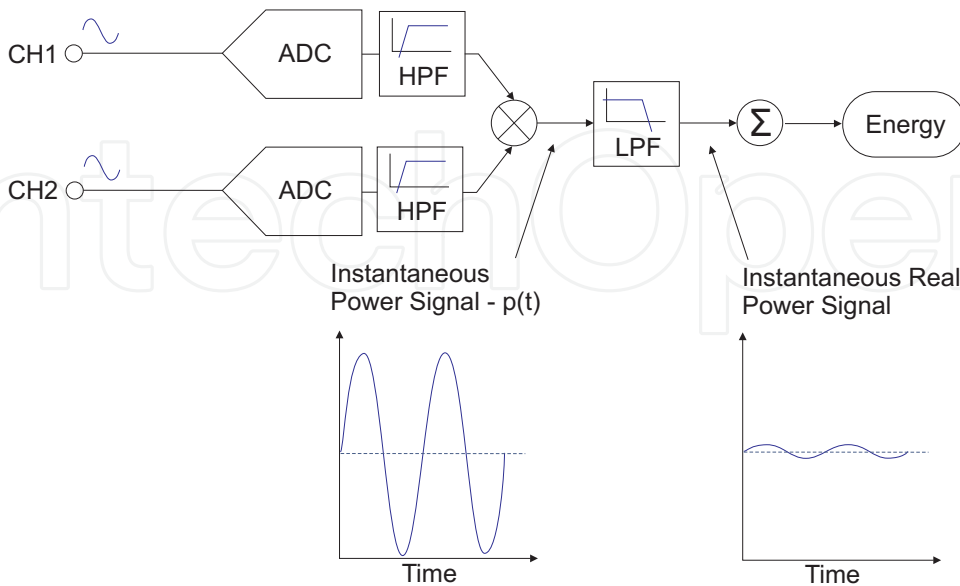

Figure 3. Signal Processing Block Diagram

Practically every current waveform in real appliances have some harmonic content. Using the Fourier transform, the instantaneous voltage can be expressed in terms of their harmonic content as:

$$v(t) = V_0 + \sqrt{2} \times \sum_{h \neq 0}^{\infty} V_h \times \sin(h\omega t + \alpha_h) \quad (4)$$

where:

$v(t)$ is the instantaneous voltage.

V_0 is the average value.

V_h is the RMS value of Voltage Harmonic h .

α_h is the phase angle of the voltage harmonic.

and the instantaneous current is given by:

$$i(t) = I_0 + \sqrt{2} \times \sum_{h \neq 0}^{\infty} I_h \times \sin(h\omega t + \beta_h) \quad (5)$$

where:

$i(t)$ is the instantaneous current.

I_0 is the dc component.

I_h is the RMS value of Current Harmonic h .

β_h is the phase angle of the current harmonic.

Thus, using Equations 1, 4 and 5, the real power P can be expressed in terms of its fundamental real power (P_1) and the harmonic real power (P_h) as:

$$P = P_1 + P_h \quad (6)$$

where P_1 is given by:

$$\begin{aligned} P_1 &= V_1 \times I_1 \cos(\phi_1) \\ \phi_1 &= \alpha_1 - \beta_1 \end{aligned} \quad (7)$$

and P_h is:

$$\begin{aligned} P_h &= \sum_{h \neq 1}^{\infty} V_h \times I_h \cos(\phi_h) \\ \phi_h &= \alpha_h - \beta_h \end{aligned} \quad (8)$$

Some energy meter ICs stores in registers the information processed in the digital domain. According to the energy meter IC, all that information (or part of it) can be retrieved via serial communication (like SPI, I²C or RS-232). Access to that information is a key element to the development of centralized systems that can identify different appliances on a household installation, as it will be shown in the further sections.

Another technique to implement precision low-cost electrical energy meters is to perform all the signal processing at software level. This can be done by using microcontrollers ICs with integrated ADCs. If a hardware multiplier is integrated in the microcontroller IC,

the multiplications that are constantly executed during the energy metering process can be executed very quickly, and measuring energy with these general purpose microcontroller ICs can be very competitive when compared to the energy meter ICs.

This technique is similar to the one implemented in hardware level, using the same acquisition methods and digital processing principles. However, using this approach, the system can be customized to operate in ultra-low power, as in the technique developed in [15] to design a battery powered energy meter using the microcontroller MSP430AFE2xx [16]. The system was configured to operate in a 60 Hz AC line and during every period of one second, make the measurements only during 3 cycles and stay sleeping for the others 57 cycles. The system calculates the RMS value of the product $V \times I$ and adds this value a register. Assuming that there is no significant change in the current and voltage during each period of less then one second, the accumulated value in the register is equal to the energy.

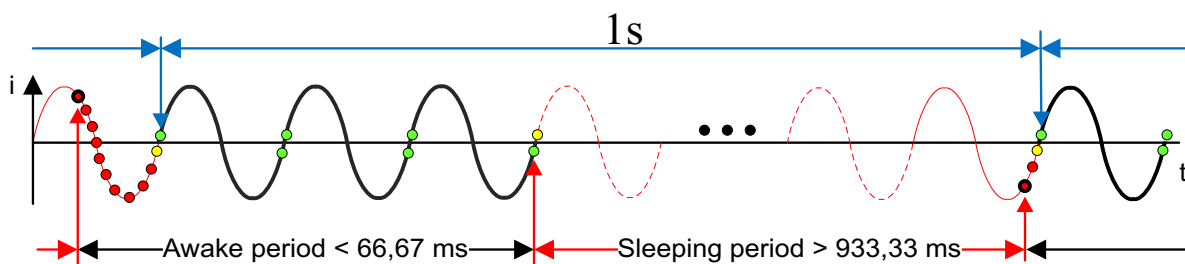

Figure 4. Awake and sleeping periods

3. Decentralized measurement methods

Establishing mesh networks using wireless and Power Line Communications modems (PLC) concentrators/routers together with smart metering sensors which are connected to the home appliances can provide both accumulated and real-time information of the energy spent in every appliance in a house. Adding actuators to these smart sensors, it is possible to manage remotely the status (on-off) of a few important loads (like clothes dryer, air conditioning) in order to avoid that these loads be turned-on during a peak period. In this case the household has to buy the system, since the information has to be continuously monitored and the energy savings will be dependent on this monitoring.

Another possibility, which does not involve the costs associated with the ownership of the measurement system, are offered as a service by the utilities or an ESCO (Energy Service Company). The energy monitoring is performed through the installation of low-cost smart metering sensors to the home appliances, and after a sampling period (typically 2 weeks), the meters are read and a diagnosis report of the energy use is prepared by the company that is offering the service. When there is no need for getting real time information, the installation is extremely easy, since the devices do not need to form a mesh network.

An example of energy monitoring system of the typical appliances in a home was presented by [19]. This proposed monitoring system presents a limited performance because only electrical appliances which were connected to the outlets could be measured, since the monitoring system could not access the lighting equipment, which represents an important part of the energy spent in many households.

4. Experimental results of a pilot project

4.1. Project overview

Recently a pilot project, supported by ANEEL (the Brazilian Electrical Energy Regulating Agency) and AES Eletropaulo (the major power electric utility in the State of São Paulo) was developed by the Department of Electronics and Microelectronics of the School of Electrical and Computer Engineering, at the University of Campinas [7]. The objective was to develop and test a prototype of a hybrid (wireless and PLC) intelligent sensor network system which should be able to perform the breakdown of the electricity bill of the customers. The premise was that with detailed information in hands, consumers could understand better how much they spend the electrical energy in every single electrical device in a house and, this would lead to changes in habits and substantial savings in electrical energy.

The developed system was planned to be offered as a service by the ESCOs, so that both customers who want to know better how they use the electrical energy and energy-efficiency programs were potential candidates for using the service. In order to be practical, the developed system had to be simple to install and easy to be deployed in a residence or small business, without requiring any changes in the original electrical wiring. Although the electrical appliances which are connected to the mains outlet could be read using a small module containing an energy meter IC, it was mandatory that the energy spent on lighting should be monitored, and special sensors had to be designed for this application.

The core of the system was designed around a ZigBee wireless sensor network, and is composed by five types of modules: a coordinator, a displaying-processing unit (DPU) and three types of smart energy meters. A PLC module was also implemented, for special cases where the mesh wireless network is difficult to be implemented.

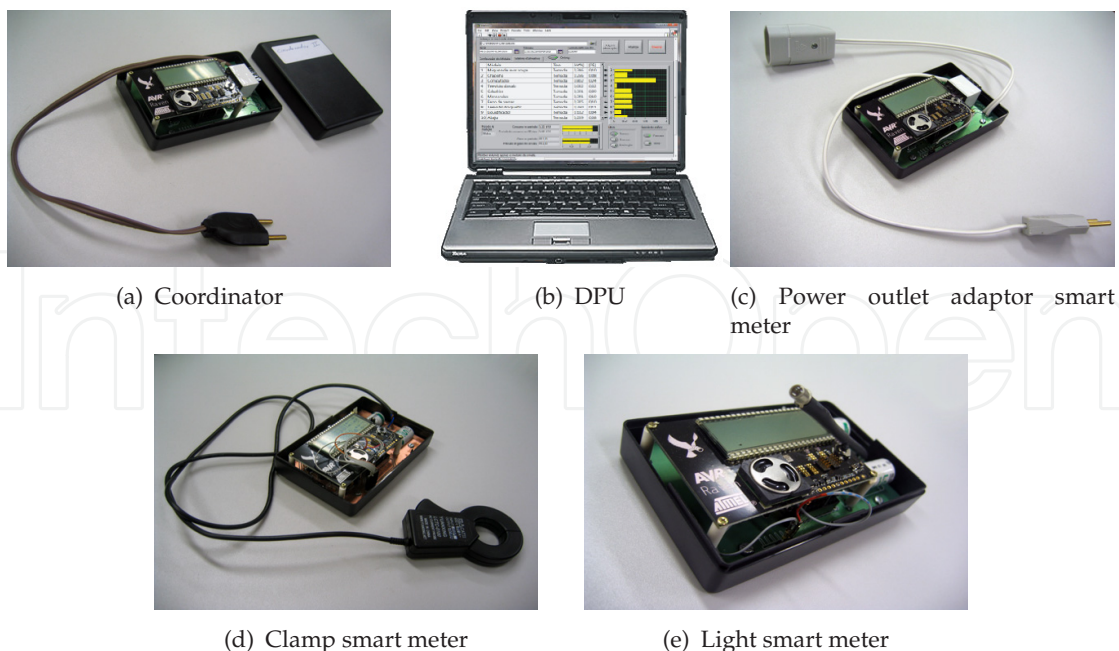

Figure 5. System modules

The coordinator is the main element, and only one module is required per each mesh network. The coordinator is responsible for storing the information sent by the smart energy

meters, and also to sustain the ZigBee mesh network. It also measures and stores the AC voltage to accurately calculate the energy from clamp smart meters. Sometimes, due to the characteristics of the local being monitored or due to the building structure/construction, it is difficult to establish the communications between some end devices and the coordinator. If the devices in the network are too far away from each other, a second coordinator can be added to create and maintain a second ZigBee mesh network. The coordinators will communicate via Power Line Communications (PLC) and a master coordinator will concatenate the information of every smart energy meter.

The hybrid communication technology used (ZigBee + PLC) made the system very robust in terms of coverage. However, the PLC is used only to transfer the information from a coordinator to another and since reading a coordinator is a simple and fast process, two (or more) coordinators can be read with the same DPU, eliminating the PLC module and resulting in a lower cost system that can be easily installed.

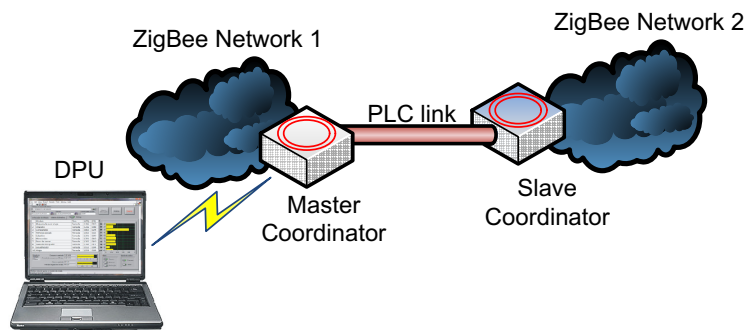
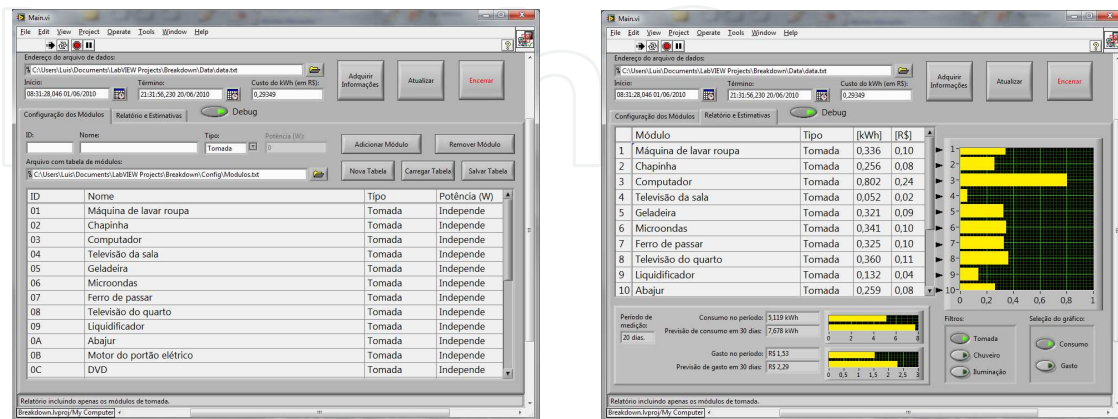

Figure 6. PLC communication connecting two wireless networks.

The DPU is basically a PC that connects to the wireless network to retrieve the information stored in the coordinator. It is also responsible for processing the information according to the configuration file created during the set-up phase (by the person who is installing the system), linking each of the appliances to the IDs of the smart energy meters. After processing, the DPU displays the report in a user-friendly screen, showing the energy spent of items in a user-friendly way, like John’s notebook, lighting of dining room, air conditioning of Rose’s bedroom, etc.



(a) First tab - Configuration file

(b) Second tab - Report

Figure 7. DPU running the reporting application.

The report has a filter that can show only one type of smart meter, two, or all tree of them. A horizontal graphic bar shows the energy consumption of each electrical device. This graphic shows the energy spent (in KWh) or the energy cost (in this software version in R\$ - Brazilian Real, but it can easily be converted to any currency) for each appliance.

Three types of smart energy meters were developed to measure and monitor the energy consumption of all electric devices in a house, without requiring any changes in the original electrical wiring installation. The first one, the power outlet adapter smart meter, is employed to measure and monitor the energy consumption of every device that can be plugged to a power outlet. The home appliance power cord is simply plugged to the smart energy meter module and the module is connected to the AC power outlet, as shown in Figure 8.

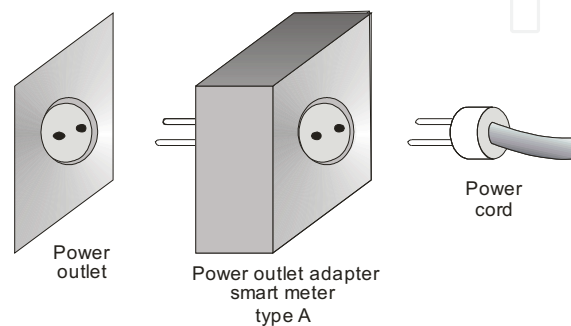

Figure 8. Power outlet adapter smart meter.

The outlet adapter meter measures the amount of energy consumed by the appliance it is monitoring, and send this information to the coordinator every five minutes. Because it is connected to the AC mains, it does not need batteries, even in the presence of a long power supply shutdown, since the data is stored in an internal flash memory. It also performs the function of a router in the wireless network, forwarding the information from the others smart meters to the coordinator, if the smart meters cannot talk to the coordinator directly.

The second smart meter is a clamp smart meter, and it runs on batteries. It was designed to monitor resistive loads that demand currents over 15 A, as it is the case of electrical showers, heaters and other high current loads. The current clamp transforms the ac current in ac voltage proportional to the amplitude of the current, and the circuit of the meter calculates the time integral of the electrical current (in Ah). It is important to remember that only the current is measured and, therefore, the energy has to be calculated. This energy calculation is performed by the network coordinator, that multiplies the data (in Ah) sent by the smart clamp meter by the average value of voltage measured by the coordinator's circuit.

The lighting smart meter developed also runs on batteries. It is employed to measure and monitor the energy consumption of lighting devices which are not accessible by the clamp meter (for example, fluorescent lights in ceiling mounting fixtures). It uses a photodiode to detect the light status (on or off). When the photodiode detects that a light (or a set of lighting fixtures) was turned on, the microcontroller starts to integrate the amount of time that the light is kept on. The system uses one light smart meter for each lighting set that is controlled by one switch. During the system installation, the nominal power of all lights that are monitored by one photodiode is stored in the microcontroller's memory, and the energy consumed by the set of lights is then calculated by the software in the DPU.

The system is designed to monitor a house for a period of one month, but it can also be used to monitor a fraction of that time and estimate the monthly cost of the electricity bill based on the acquisition period, for households with very stable and repetitive habits. A period of less than two weeks is not accurate, because some important energy hungry events may be missed, like when there is no need for using the cloth drier machine because the weather was very good in that week.

4.2. Field test results

The system was tested in the field, and the results showed that most of the consumers waste a lot of energy due to habits that could be easily changed without any impact on the comfort or the quality of life.

Table 1 shows the results measured in a very small apartment, with one person who leaves the apartment early in the morning and returns only at 7:00 PM. It can be seen that this household spends 76% of the electricity with only two appliances: a Computer and a VCR. The PC is a high load in this household, with 64% of the monitored energy consumption. After the report on how the energy is used was presented, the resident reported that the PC is a high end device with powerful video cards and was kept on 24/7 just to eliminate the slow boot time. Concerning the VCR (which is responsible for about 12% of the consumption), it was informed that it is a very old model, that is never turned-off and is used only to change the channels in the TV, because the TV's remote control was not working. In this case, the energy savings could reach a level of almost 80% if the computer is turned off when it is not in use and a new TV remote control is bought.

Appliance	Energy %
TV	17.93%
Cell Phone + Charger	1.00%
VCR	12.71%
Refrigerator	3.78%
PC	64.00%
Light bulb 20W (kitchen)	0.58%
TOTAL	100.00%

Table 1. Results measured in a small apartment with 1 people

The results from another household, a medium size apartment with 3 people, is presented in table 2.

This test found that the resident has an old digital alarm clock/radio (which, obviously, was kept turned on 24/7) that presents a huge energy consumption. If this alarm clock was replaced with a new and more economic model, it would pay itself back after a few months and energy savings in the order of 12% would be achieved.

The results measured in another interesting case, a large house with three people, are presented in table 3. This household shows a high energy consumption by computers and televisions. The residents reported that the treadmill was kept in stand by during all the acquisition period, and a TV set on a bedroom is always kept on during the whole night. The PCs are also left on continuously to avoid the slow boot time.

Appliance	Energy %
Notebook	0.03%
Hair Dryer	0.53%
Washer/Dryer Machine	0.72%
TV (living room)	11.26%
Refrigerator 1	10.37%
Microwave	1.04%
Alarm clock/radio	12.20%
Lighting 50W (over the piano)	0.03%
Lighting 50W (bathroom)	0.00%
Lighting 50W (kitchen)	22.55%
Lighting 50W (office - over the PC)	7.47%
Lighting 50W (office)	2.37%
Refrigerator 2	15.48%
Cordless telephone	12.23%
TV (bedroom)	3.72%
TOTAL	100.00%

Table 2. Results measured in a medium size apartment with 3 people

Appliance	Energy %
PC with amplified speakers	10.83%
Home Theater	0.00%
Electric rice cooker	1.58%
Satellite TV receptor	2.57%
Treadmill	2.24%
PC with wireless dongle	19.40%
PC + Wireless router + notebook	18.48%
Cordless telephone	0.89%
TV LCD 43" (bedroom)	16.71%
Microwave	0.56%
Lighting 120W (TV room)	0.05%
Refrigerator + freezer (side-by-side)	16.36%
TV LCD 53" (TV room)	9.00%
Lighting 160W (kitchen)	1.30%
Lighting 50W (closet)	0.02%
TOTAL	100.00%

Table 3. Results measured in a large house with 3 people

From the results of the field tests it was observed that habits and behavior are responsible for a lot of energy waste. From the results measured in these households it becomes clear that a detailed report with the breakdown of the electricity bill can result in significant electrical energy savings just by changing habits.

In the case presented in table 3, the electricity bill was monitored during the next six months after the results were presented. The family reported that, after the report was presented, all three PCs were turned-off during the night and the timer of the bedroom TV was set to turn-off the TV set at midnight. In the case of the The monthly savings in the electricity bills during these six months period were over 20%, when compared to the same month of the previous year. This result is a clear evidence that if a customer is informed of a habit that is wasting energy and this habit can be easily changed, a lot of energy can be saved and and this savings tend to be permanent.

The measurement system was designed to get the information from every appliance in the house in real time, but the customers reported that they were interested only in the two weeks final result. Thus, the ZigBee network could be removed from the smart meters and a simple peer-to-peer communication (from each smart meter to the DPU) could be used, reducing the power consumption of the measurement system and increasing the batteries' life.

5. Centralized measurement methods

With the main objective of minimizing the number of sensors needed to monitor all appliances and also reducing the complexity of the installation service, many researchers are proposing centralized measurement approaches. There are several proposals of different techniques to identify the appliances connected in the same circuit.

In [22] the authors presented the design and implementation of a wireless monitoring system for residential spaces, based on a a multi-layer decision architecture called TinyEARS. This system was able to recognize the appliances by deploying one acoustic sensor node per room, that will identify the appliances' acoustic signatures. Combining this information with the data acquired by a real-time power meter installed at the main electric panel and with relatively simple processing algorithms the system can recognize the appliances with an overall success rate of 94%.

Another technique widely adopted is the identification based on load signatures. Load Signature is an electrical expression that an appliance distinctly possesses regarding its electrical consumption behavior. It can be measured in various forms. From power consumption levels to waveforms of electrical quantities such as voltage and current. Almost every electrical measurement can be treated as a load signature. It can be represented in the frequency domain [6], in the time domain [11] and can also be represented mathematically in terms of wavelets, eigenvalues, or components of the Singular Value Decomposition (SVD) [12].

Methodologies which use signal processing techniques and estimation algorithms for signal load recognition based on load signatures allows the use of a single intelligent device in only one point of the installation (in the electric panel). The detailed energy breakdown of the whole installation is then calculated by sophisticated algorithms.

One of the earliest works (1980's) in nonintrusive monitoring was developed at MIT and had its origins in load monitoring for residential buildings [9]. In the developed technique the operating schedules of individual loads are determined by identifying times at which electrical power measurements change from one steady-state value to another. These steady-state changes, known as events, correspond to the load either being turning on (or turning off), and can be characterized by the magnitude and sign in real and reactive power values. Figure 9 shows the power consumption of a refrigerator and a microwave oven, where

two different-sized step changes are clearly present, providing characteristic signatures of the refrigerator and the microwave oven. Knowing the time of each on and off event, it is possible to determine the total energy consumption of the refrigerator and the microwave oven.

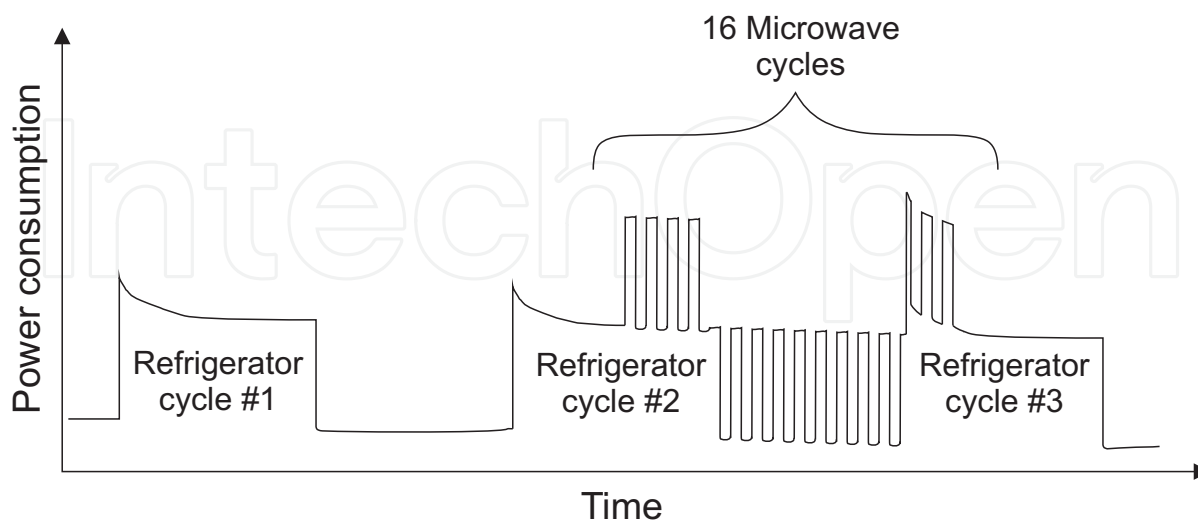

Figure 9. Characteristic signatures of a refrigerator and a microwave oven sensed on the same circuit

In [12] the authors highlighted the fact that the complex electrical loads of today have signatures that vary with time, depending on their state and mode of use and that common appliances can have non-linear load characteristics. They propose a conceptual modeling to characterize an appliance based on three sets of signatures that are extracted from the appliance: steady state, transient state and operational pattern and therefore construct a taxonomy for the appliances.

A method to construct taxonomy of electrical appliances based on load signatures is presented in [10]. In this work the authors suggest a 2-dimensional form of load signature denominated voltage-current (V-I) trajectory to characterize typical household appliances. The V-I trajectory load signatures consists in acquiring the steady-state voltage and current in one-cycle long, normalize them to eliminate the effect of the current magnitude in the size of V-I trajectory, and then plot the V-I trajectory. After creating the trajectories for the appliances, the shapes of the trajectories of the appliances can be analyzed.

The proposed methodology for constructing the load taxonomy is summarized as: (1) the voltage and current waveforms of the household appliances are measured; (2) load signatures in the form of V-I trajectory are constructed; (3) shape features are extracted from the V-I trajectories; (4) hierarchical clustering method is applied to cluster the appliances; (5) the load taxonomy is constructed according to the clustering results.

In [13] the authors proposed a methodology of using load signatures and Genetic Algorithms (GA) to identify electrical appliances from a composite load signal. They introduced a classification method to group the appliances and how to disaggregate the composite load signals by a GA identification process from a generated random combinations of load signatures from the groups of appliances.

The methodology consists of defining a signature for each appliance by averaging 50 consecutive one-cycle steady-state current waveforms. Then the current waveforms are grouped by the ratio of their fundamental (50Hz) component versus their Root-Mean-Square (RMS) total, after a Fast Fourier Transform (FFT) calculation. That means that the higher the

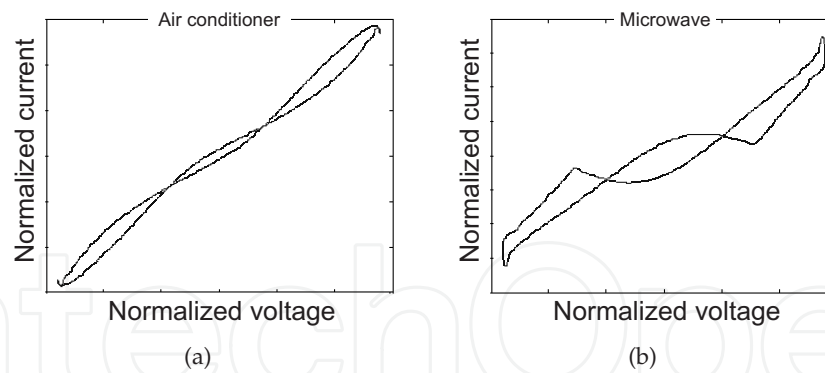

Figure 10. Examples of V-I trajectories of (a) an air conditioner and (b) a microwave oven

ratio, the more sinusoidal shape of the signature is. They considered a sampling rate of 200 points per cycle (50Hz), which is sufficient for steady-state assessment in the time-domain. However, higher sampling rate is desirable if transients will be also analyzed.

The appliances identification can be done by making use of Genetic Algorithms, which are stochastic global search methods based on the principle of the fittest survives. A fitness function, which calculates the least sum squared error between the proposed aggregated signal and the measured signal, is firstly defined. A group of potential solutions are also defined as the initial population. Different variables/attributes, termed the genes, which would affect the fitness function, are allowed to cross-over and mutate to form new generation of potential solutions. In each generation, those matches having the highest fitness value would be retained for further reproduction. The process repeated itself until the best fit is found or the generation limit is reached.

The identification accuracy of the Genetic Algorithm technique is very high for a small number of appliances, but it decreases as the number of aggregated appliances increases. Also, the identification accuracy for sinusoid and quasi-sinusoid waveforms is lower than those of non-sinusoid signatures.

A different approach based on centralized measurement is presented in [14]. The proposed methodology detects the state changes of appliances and acquire energy information simultaneously. The appliance identification is performed using power meters installed in the circuit-level of the electrical panel, and measures the total electrical consumption every 5 seconds, assuming that all appliances and the states of these appliances in the circuit are known.

In addition, user behavior is taken into account, as the algorithms assume that there are some patterns for using appliances. For example, when using the computer, first the user may switch on the light in the room, then start up the power of the computer and finally turn on the monitor. If the user has a regular lifestyle, the pattern is likely to be regular. Based on that assumption, the temporal character is taken into consideration, therefore, the Dynamic Bayesian Network (DBN) is applicable.

A recent proposal [5] proposes the use of several energy meters ICs, one for each circuit breaker in the electrical panel. This approach aims to minimize the number of appliances sensed in the same circuit breaker. If equal loads, which would present almost perfectly matched load signatures (for example, two air conditioning systems) are connected to different circuit breakers, the identification will be very simple, since it is performed per

circuit breaker. The technique under development presents a methodology to disaggregate the power consumption information of each appliance based on synchrophasors as load signatures.

6. Conclusions

A compilation of several state-of-the-art methods that can be used to obtain detailed information about the energy consumed by the appliances in a household has been presented. The decentralized systems, where it is necessary to install one meter per home appliance, are more suitable to be employed in energy efficiency programs where the objective is to present a report of the breakdown of the electricity bill to the family. It has been observed that, based on the reports, many customers implement important (and sometimes simple) changes in habits that lead to effective energy savings.

When it is desired to permanently monitor the household appliances in real time, for example to control the demand in small business installations or to shift the use of energy from peak periods to low-cost tariffs non-peak periods, usually the centralized systems are more efficient. However, these systems are not yet capable of performing a complete identification of all the appliances installed, and further investigations are required in these type of systems.

Advanced metering initiatives are fundamental for providing accurate information and understanding on how and where the energy is being used in a household, and also to evaluate the actual results of implemented energy efficiency programs. Educating people by showing how they can make a better use of the electrical energy seems to be the key element to promote permanent energy savings.

7. Acknowledgements

This research is partially supported by CAPES.

Author details

Luís F. C. Duarte, Elnatan C. Ferreira and José A. Siqueira Dias

Department of Electronics and Microelectronics. School of Electrical and Computer Engineering of University of Campinas. Campinas, SP - Brazil

8. References

- [1] AD71056 Data Sheet - Energy Metering IC with Integrated Oscillator and Reverse Polarity Indication [2006]. Analog Devices.
- [2] ADE7953 Data Sheet - Single Phase, Multifunction Metering IC with Neutral Current Measurement [2011]. Analog Devices.
- [3] BP [2009]. Statistical review of world energy 2009.
- [4] Darby, S. [2006]. *The effectiveness of feedback on energy consumption. A review for DEFRA of the literature on metering, billing and direct displays*, Environmental Change Institute, University of Oxford.
- [5] DEMIC/FEEC/UNICAMP [2012]. Monitoring power consumption of in-house appliances by measuring the distribution board in circuit-level. Pre-proposal for a corporate-sponsored research agreement.

- [6] Duan, J., Czarkowski, D. & Zabar, Z. [2004]. Neural network approach for estimation of load composition, *IEEE International Symposium on Circuit and Systems (ISCAS)*, pp. 988–991.
- [7] Duarte, L. F. C., Zambianco, J. D., Airoidi, D., Ferreira, E. C. & Dias, J. A. S. [2011]. Characterization and breakdown of the electricity bill using custom smart meters: A tool for energy-efficiency programs, *International Journal of Circuits, Systems and Signal Processing* 5(2): 116–123.
- [8] Ehrhardt-Martinez, K., Donnelly, K. A. & Laitner, J. A. [2010]. Advanced metering initiatives and residential feedback programs: A meta-review for household electricity-saving opportunities, *Technical report*, ACEEE.
- [9] Hart, G. W. [1992]. Nonintrusive appliance load monitoring, *Proceedings of the IEEE* 80(12): 1870–1891.
- [10] Lam, H. Y., Fung, G. S. K. & Lee, W. K. [2007]. A novel method to construct taxonomy of electrical appliances based on load signatures, 53(2): 653–660.
- [11] Laughman, C., Lee, K., Cox, R., Shaw, S., Leeb, S., Norford, L. & Armstrong, P. [2003]. Power signature analysis.
- [12] Lee, W. K., Fung, G. S. K., Lam, H. Y. & Chan, F. H. Y. [2004]. Exploration on load signatures, *Proceedings of International Conference on Electrical Engineering (ICEE)*.
- [13] Leung, J. S. K., Ng, K. S. H. & Cheng, J. W. M. [2007]. Identifying appliances using load signatures and genetic algorithms, *Proceedings of International Conference on Electrical Engineering (ICEE)*.
- [14] Lin, G., Lee, S., Hsu, J. Y. & Jih, W. [2010]. Applying power meters for appliance recognition on the electric panel, *Proceedings of the 5th IEEE Conference on Industrial Electronics and Applications (ICIEA)*, pp. 2254–2259.
- [15] Morais, F. J. O. [2011]. *Low power electronic equipment with wireless communication to aid in electrical power theft detection*, Master's thesis, University of Campinas.
- [16] MSP430AFE253 Data Sheet - Mixed Signal Microcontroller [2011]. Texas Instruments.
- [17] Prindle, W. [2010]. *Customer incentives for energy efficiency through program offerings*, National Action Plan for Energy Efficiency, ICF International, Inc.
- [18] Rosca, M. [2008]. Thermal energy supply strategy for the city of Oradea, Romania, *4th IASME/WSEAS International Conference on ENERGY, ENVIRONMENT, ECOSYSTEMS and SUSTAINABLE DEVELOPMENT (EEESD'08)*.
- [19] Serra, H., Correia, J., Gano, A. J., de Campos, A. M. & Teixeira, I. [2005]. Domestic power consumption measurement and automatic home appliance detection, *Proceedings of 2005 IEEE International Workshop Intelligent Signal Processing*, pp. 128–132.
- [20] Shanming, W. & Schaefer, U. [2007]. Design and optimization of 8MW directly driven surface mounted permanent magnet wind generators, *Proceedings of the Seventh IASTED International Conference on Power and Energy Systems*.
- [21] Solomon, S., Qin, D., Manning, M., Chen, Z., Marquis, M., Averyt, K. B., Tignor, M. & Miller, H. L. [2007]. In: *Climate Change 2007: The physical science basis. Contribution of working group I to the fourth assessment report of the intergovernmental panel on climate change*. IPCC, 2007: Summary for Policymakers. Cambridge University Press, Cambridge, United Kingdom and New York, NY, USA.
- [22] Taysi, Z. C., Guvensan, M. A. & Melodia, T. [2010]. TinyEARS: Spying on house appliances with audio sensor nodes, *Proceedings of the 2nd ACM Workshop on Embedded Sensing Systems for Energy-Efficiency in Building (BuildSys '10)*.
- [23] Vojcinak, P., Vrtek, M., Hajovsky, R. & Koziorek, J. [2010]. Evaluation and monitoring of effectiveness of heat pumps via COP parameter, *Proceedings of the International Conference on Circuits, Systems and Signals*.