

We are IntechOpen, the world's leading publisher of Open Access books Built by scientists, for scientists

4,400

Open access books available

117,000

International authors and editors

130M

Downloads

Our authors are among the

154

Countries delivered to

TOP 1%

most cited scientists

12.2%

Contributors from top 500 universities



WEB OF SCIENCE™

Selection of our books indexed in the Book Citation Index
in Web of Science™ Core Collection (BKCI)

Interested in publishing with us?
Contact book.department@intechopen.com

Numbers displayed above are based on latest data collected.
For more information visit www.intechopen.com



Optimal Sizing of Harmonic Filters in Electrical Systems: Application of a Double Simulated Annealing Process

Laurence Miègeville and Patrick Guérin

Additional information is available at the end of the chapter

<http://dx.doi.org/10.5772/51661>

1. Introduction

Many fields including management science, computer science, electrical and industrial engineering bring into play a number of combinatorial optimisation problems that consist in finding the global minimum of a cost function that may possess several local minima over a finite or infinite set of solutions. In practice, excellent results have been obtained by using local search algorithms for a wide variety of issues, leading thus to a growing interest in theoretical results. However, many problems are still open as a challenge. In the current chapter, the authors present their experience in using a double simulated annealing (SA) optimisation process applied to the search for the optimal sizing of harmonic filters placed in a distribution electrical system. The effectiveness of the SA algorithm will be herein argued and illustrated on a distribution system so as to characterise the suitable placement of filtering devices that leads to a minimum required power. One of its main benefits compared with a popular genetic algorithm for example is to supervise the configuration space at every moment and to control the convergence process.

Nowadays, harmonic filters are widely installed in distribution systems for harmonic current filtering to achieve harmonic distortion reduction. The extent of this benefit depends greatly on the filtering system placement. Then, the problem focuses on several formulations about filters locations, their types and sizes. In the past, many efforts were put into the capacitor placement for reactive power compensation [1] even with a distorted substation voltage [2]. Many optimisation methods have found a practical application in this problem and the fuzzy logic [3], the simulated annealing [4], as well as the genetic algorithm [5] have been tested on it. A less attention has been paid for harmonic filters. A formulation

has been proposed in [6] with analytical expressions, which have been solved by a graphic method. The placement and sizing of a single filter have been also studied in [7] by a graphic approach. More recently, an equivalent resistance approach [8] has been applied to the location of a single-tuned passive filter.

In the present chapter, the problem is formulated to minimise the filtering power with respect to the bus voltage constraints by limiting the harmonic currents passing through the filtering system. Corresponding to the harmonic currents either drawn by a passive filter or injected by an active filter, the filtering currents are calculated not to cancel the resulting harmonic voltages as proposed in [9], but to bring their magnitude within the limits recommended by the standards [10]. The optimisation of the filter size is then applied separately for each harmonic order by means of a double SA process ruled by two distinctive objective functions and the results are known in terms of filtering power to install with the resultant harmonic voltages expected on the distribution network.

As the number of busbars able to receive harmonic filters is usually limited in industrial plants or on board power systems, all the possible configurations can be individually considered and analysed thanks to a fast harmonic simulation schedule using the analytical models of static converters. Consequently, the search for the suited number of filters, their best location and their respective dimensioning power can be properly conducted.

The present chapter will clearly stress on the promising results provided by the SA theory when dealing with practical optimisation issues, like the placement and the sizing of harmonic filters that it deals with. The real power system of an electric propulsion ship will be then considered for illustration purposes.

2. Simulated annealing overview

The SA process is motivated by an analogy to annealing in solids. The idea comes first from a paper published by Metropolis et al. in 1953 [11]. An algorithm was then proposed to simulate the cooling of a material in a heat bath. This is a process known as annealing. The structural properties of a material that is heated past melting point and cooled afterwards depend on the rate of cooling. In consequence, if the liquid is cooled slowly enough, thermal mobility is lost and large crystals well ordered are formed, which is the state of minimum energy for the system. Conversely, if the liquid is cooled quickly, the crystals contain imperfections and the process becomes a simulated quenching that cannot ensure the achievement of a low energy state.

Metropolis's algorithm simulates the cooling process by gradually lowering the temperature of the system until it converges to a steady frozen state. In 1982, Kirkpatrick et al. [12] took the idea of the Metropolis's algorithm and applied it to optimisation problem. The SA process is then used to search for feasible solutions and converge to an optimal solution.

The popularity of the SA theory comes from its ability to solve complex combinatorial optimisation problems which purpose is to develop an efficient technique for finding minimum or maximum values of a function with many degrees of freedom and many local minima. Based on principles of physics, a combinatorial problem can be viewed as a thermodynamic system where all the equilibrium properties can be resolved by standard statistical mechanical methods [13]. Then, states in thermodynamic usage are identified with solutions in a combinatorial optimisation problem. Energy in thermodynamics is the cost function to be minimised in a SA process. The solution space of the optimisation problem is explored by a probabilistic hill climbing search which step size is controlled by a parameter T that plays the same role of the temperature in the physical system. Therefore, the abstract system can be described as if it was a thermal physical system which aim is to locate the ground state (i.e. optimal solution) while the temperature declines.

In a typical SA process, the initial temperature is set sufficiently high. A new state X_j is generated incrementally from the current state X_i by randomly selecting and proposing a move from a set of predefined ones.

Let the energy of the current state be $f(X_i)$ and the energy of the new one be $f(X_j)$. The probability that a proposed move is accepted or rejected in the SA theory is determined by the Metropolis criterion (1):

$$P(\Delta f_{ij}) = \min \left\{ 1, P_{\text{Boltz}} = \exp\left(-\frac{\Delta f_{ij}}{kT}\right) \right\} \quad (1)$$

where

$\Delta f_{ij} = f(X_j) - f(X_i)$ is the proposed energy change,

k is a constant known as Boltzmann's constant relating temperature to energy.

It can be then appreciated that if the energy is decreased, the so-called Boltzmann probability P_{Boltz} is greater than the unity. In that condition, the change is arbitrarily assigned to a probability $P(\Delta f_{ij})$ equal to one, which means that the system always moves to this state. Conversely, if the energy is increased, the new state is accepted using the acceptance distribution p_{ij} , as stated in (2):

$$p_{ij} < P_{\text{Boltz}} \quad (2)$$

where

p_{ij} stands for a uniform random number between 0 and 1.

When the proposed move is accepted, the new state becomes the current state; when it is rejected, the current state remains unchanged. Therefore, by controlling the temperature T , the probability of accepting a hill climbing move which results in a positive Δf_{ij} is also controlled and the exploration of the state space too.

The driving mechanism of the SA process is described in Figure 1. The process of selecting and proposing a move is repeated until the system is considered in thermal equilibrium. Then, the temperature is reduced according to a temperature schedule and the system is allowed to reach thermal equilibrium again. Then, as the temperature of the system declines, the probability of accepting a worse move is decreased. This is the same as gradually moving to a frozen state in physical annealing. The process is finally stopped when no significant improvement is expected by further lowering temperature. At this point, the current state of the system is the solution to the optimisation problem.

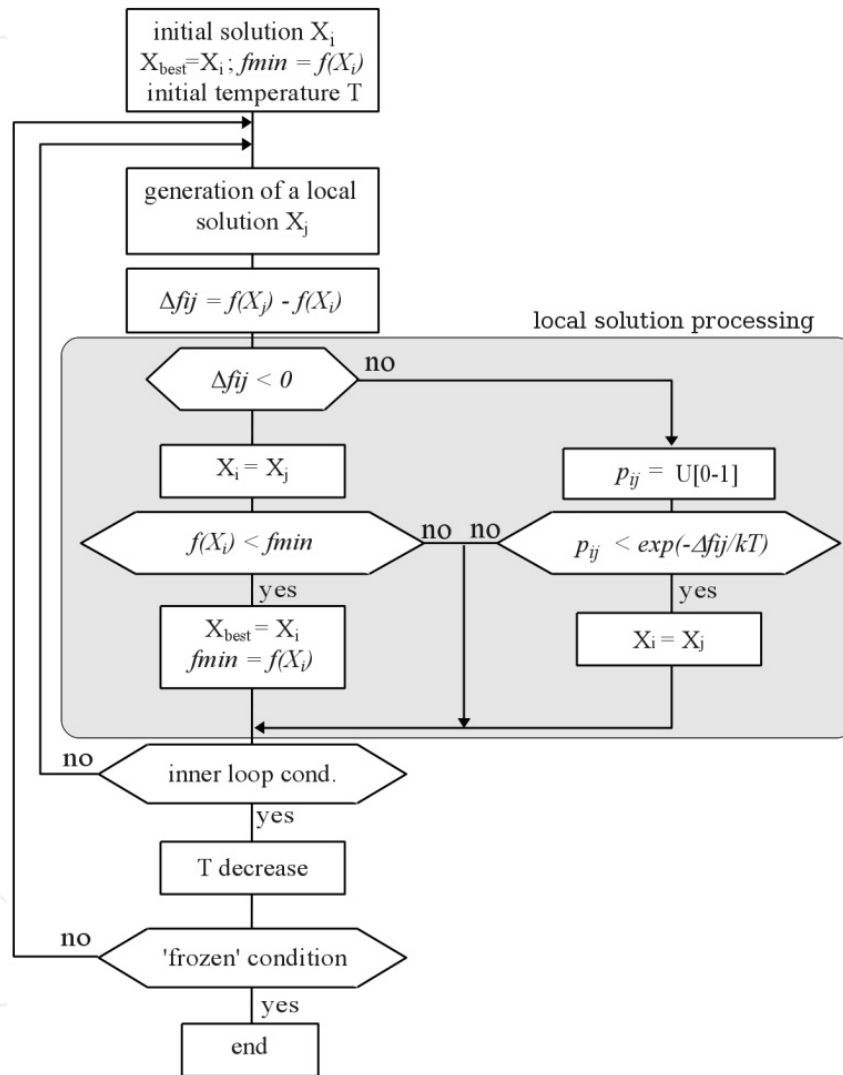

Figure 1. SA algorithm

The major advantage of a SA process over other methods is its ability to avoid becoming trapped in local minima. The algorithm employs a random search which not only accepts changes that decrease the objective function, but also some changes that can increase it. In consequence, a worse move can be accepted temporarily by leading subsequently to an improving solution. Then, the system sometimes goes uphill as well as downhill. However, the lower the temperature, the less likely is any significant uphill excursion.

Most of the practical applications of the SA theory are in complex problem domains, where algorithms either did not exist or performed poorly. Among the considerations which have led to the choice of a SA process for solving the current issue are its ease of implementation and its flexibility in applications to complex optimisation problems, especially ones where a desired global extremum can be hidden among many poorer local extrema. Besides, compared to some other popular methods like genetic algorithms, a SA process offers a far well mastered solution space to explore. Indeed, it can be appreciated that the neighbourhood becomes smaller as the global optimal solution is closer, which makes the search process easier and speeds up the convergence. It is also important to ensure that this condition is met when thinking about one's problem. For all those reasons, a SA process applied to the search for the optimal placement and power sizing of harmonic filters on large-scale electrical systems can be considered as a suitable optimisation method.

3. Problem statement

3.1. Network representation

The present harmonic filtering study is based on the usual assumptions about the symmetry of the electrical network, the balance of the harmonic currents generated by the non-linear loads, and the independence between the harmonic orders. As a result, a single phase network is considered and the analysis is carried out for each individual harmonic order. Then, the relationship between nodal harmonic currents and voltages is defined through the admittance matrix [14], as follows:

$$\mathbf{I}_h = \mathbf{Y}_h \cdot \mathbf{V}_h \quad (3)$$

where

I_h : the vector of the nodal harmonic currents,

Y_h : the harmonic admittance matrix,

V_h : the vector of the nodal harmonic voltages,

h : the harmonic order.

The nodal admittance matrix is obtained from the impedance of every network component and the nodal currents are given from the harmonic currents generated by the non-linear loads.

In industrial distribution systems, loads are supplied through transformers by different voltage levels according to their rated power. Due to the voltage supplies, the filtering current is modified by the transformer ratio when the filter is connected to the primary or to the secondary side of the transformer. In consequence, the comparison between the set of solutions requires considering a per-unit system.

Let V_n be a vector composed of the nominal nodal voltages. The admittance matrix formulation (3) can be then rewritten in an equivalent system where the relationship (5) between nodal harmonic currents and voltages becomes independent from the nominal nodal voltages.

$$\mathbf{V}_n \cdot \mathbf{I}_h = \mathbf{V}_n^2 \cdot \mathbf{Y}_h \cdot \frac{\mathbf{V}_h}{\mathbf{V}_n} \quad (4)$$

$$\mathbf{i}_h = \mathbf{y}_h \cdot \mathbf{v}_h \quad (5)$$

where

$\mathbf{i}_h = \mathbf{V}_n \cdot \mathbf{I}_h$: the vector of the equivalent injected currents in kVA,

$\mathbf{y}_h = \mathbf{V}_n^2 \cdot \mathbf{Y}_h$: the equivalent admittance matrix in kVA,

$\mathbf{v}_h = \frac{\mathbf{V}_h}{\mathbf{V}_n}$: the vector of the equivalent voltages in %.

Besides, an active filter connected to the node k can be considered as a current source which injects a current j_{hk} on the network. A passive filter can be also modelled by a current source which magnitude would represent the harmonic current that must be drawn by the filter. In this last case, the phase angle depends on the harmonic voltage at the coupling node. All the additional currents produced by the set of filters are intended to reduce the harmonic voltages at each busbar. The location of these filters is defined in a node list called *ListFilter*. Assuming a given number of filters, the harmonic voltages are deduced from (6):

$$\mathbf{v}_h = \mathbf{z}_h \cdot (\mathbf{i}_h + \mathbf{j}_h) \quad (6)$$

where

\mathbf{j}_h is the vector of the filtering current and $\mathbf{z}_h = \mathbf{y}_h^{-1}$ the equivalent impedance matrix.

3.2. Optimisation process

The aim of the current optimisation problem is to minimise the total filtering power to connect to the grid while the voltage standards are met for each nodal harmonic voltages. Prior to the search for the optimal current to be injected, it is necessary to answer a first question about the possibility to obtain a current vector j_h able to reduce the voltages within the limiting levels v_{limit} at each node. For this reason, a double SA process is applied, as illustrated by the complete flow chart of figure 2. The purpose of the first one is to minimise the harmonic voltages, while checking if a filtering solution is existing or not.

In cases where no filtering solution can be found, the simulated voltage annealing is fully processed and returns the total filtering current j_{total} able to check a minimum gap between the nodal harmonic voltages and their expected limits. Instead, when the voltage constraints are properly respected, the voltage annealing is partially processed. Once a local solution is achieved, the procedure is switched to a simulated current annealing which purpose is to minimise the total filtering current j_{total} that meets the voltage requirements. The search space is actually the same regardless of the nature of the SA process; what is however different is the objective function, as will be argued further in the subsection 3.2.2.

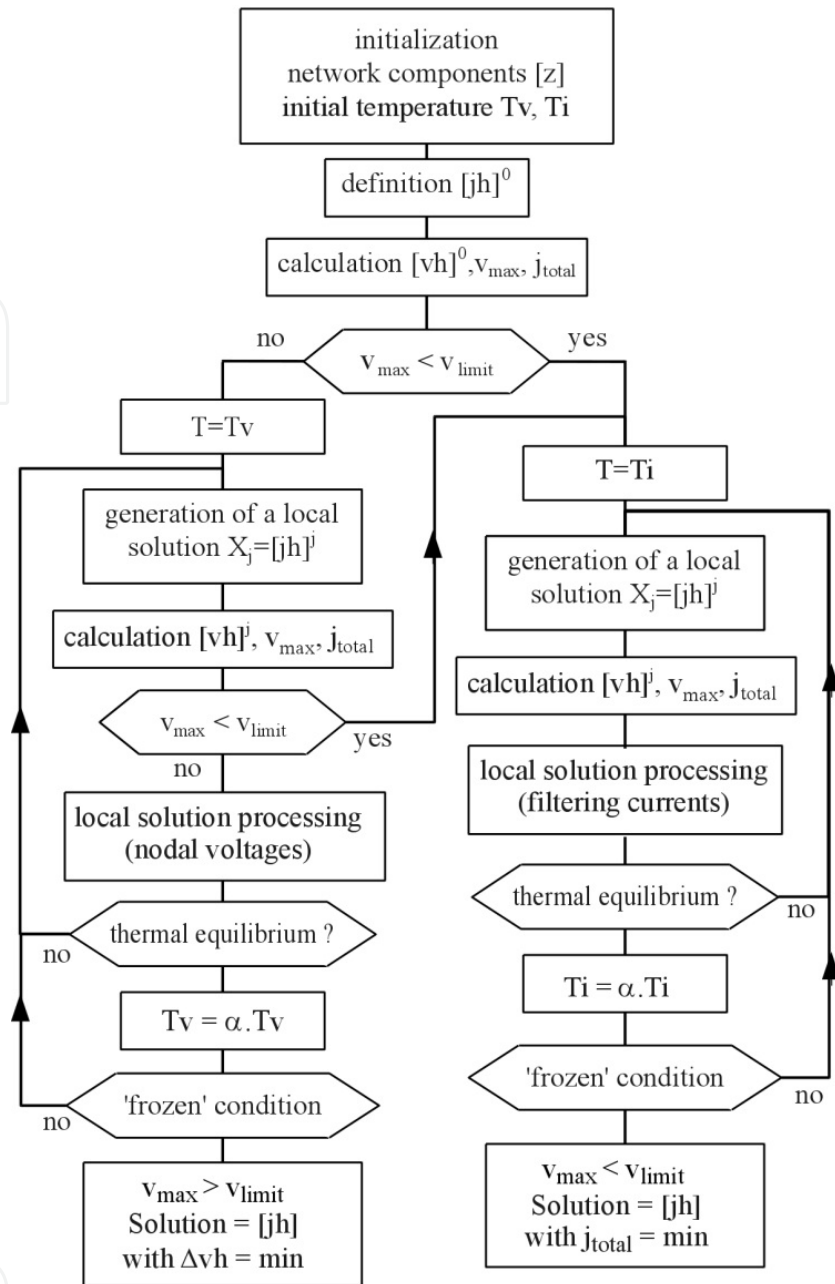

Figure 2. General flow chart of the optimisation procedure

The implementation of the algorithm is detailed further below and the focus is on the major parts of the procedure that can influence the behaviour of the SA approach to optimisation.

3.2.1. Initialisation procedure

When thinking about any optimisation problem, one of the first considerations is to start with a suitable set of initial parameters in order to ensure a good algorithm performance, which means the quality of the solution returned and a reasonable computation time [15]. The initialisation procedure deals first with the definition of the problem's data linked to the specific application. It consists herein of the following input data:

- the electrical system's components,
- the initial vector current j_n^0 , assessed from the cancellation of the harmonic voltages at each node where a filter is connected,
- the resultant voltages v_n^0 , calculated from the network impedances,
- the maximum voltage amplitude v_{max} initially observed in the whole electrical system,
- the total filtering current j_{total} .

The initialisation procedure also starts with the parameters settings for the SA process, i.e. the cooling schedule that consists of the initial temperature and the rules for lowering it as the search for the optimal solution progresses. Each of these specific features will be introduced and explained, regarding the current issue about the optimal placement and sizing of harmonic filters in electrical systems.

- Starting temperature

In a typical SA process, the initial temperature is set sufficiently high to allow a move to almost any neighbourhood state. However, if the temperature starts at a too high value, the search may move to any neighbour and thus transform it into a random search, at least in the early stages. At the moment, there is no known method for finding a suitable starting temperature for a whole range of problems. An idea is to use the information on the cost function difference between one neighbour and another one to calculate a correct initial temperature. Another method suggested in [13] is to rapidly heat the system until a certain proportion of worse solutions are accepted and then slow cooling can start.

In the current application where a double SA process is considered, two initial temperatures for the voltage and the current annealing respectively are set as defined in (7) and (8). The both relationships mean that a 60% tolerance is allowed as regards the acceptance of an unfavourable harmonic voltage equal to twice the required limits and a jump of 30% in the amplitude of the average current is accepted with a same 60% tolerance.

$$T_v = -\frac{2 \times \max(\mathbf{v}_{limit})}{\ln(0.6)} \quad (7)$$

$$T_i = -\frac{0.3 \times \sum_{q \in ListFilter} |j_{hq}^0|}{\ln(0.6)} \quad (8)$$

- Final temperature

It is usual to let the temperature decrease until it reaches zero. However, this can make the algorithm run for too long, which should be a major drawback. In practice, the stopping criterion is a suitably low temperature, since the chances of accepting a worse move are almost the same when the temperature is null. In other words, the stopping criterion is met when the system is frozen at the current temperature; that is, no better or worse moves are being accepted.

- Cooling schedule

The temperature decreases during the search according to a function known as the cooling (or annealing) schedule. The way in which the temperature declines is critical to the success of the algorithm. Theory states that the number of iterations to execute at each temperature should be large enough to reach the thermal equilibrium.

In the literature, several theoretical and empirical control schemes are suggested [16-19] and can be categorised into classes such as monotonic schedules, geometric schedules, quadratic schedules and adaptive cooling schedules. Actually, many attempts have been made to derive or suggest good annealing schedules. Several comparative studies on the large variety of proposed cooling strategies are discussed in [20-22].

In a conventional SA process, the way to decrement the temperature is a simple linear method. By declining the temperature constantly, it provides the search with a higher transition probability in the beginning of the search and lower probability towards the end of the search. An alternative is a geometric decrease by a constant factor α ($0 < \alpha < 1$). Then, experience shows that α should lie between [0.8 – 0.99], with better results found in the higher end of the range. However, the higher the value of α , the longer it will take to decrement the temperature to the stopping criterion.

The proposed annealing procedure tested on the minimum power sizing scheduling problem involves the above cooling schedule known as an exponential schedule (9), with a coefficient α equal to 0.95 in order to compromise between computation time and optimisation performance.

$$T(t) = T_0 \cdot \alpha^t \quad (9)$$

where t (for 'time') is the step count and T_0 is the starting temperature.

- Iterations at each temperature

The final decision to make is the number of iterations to consider at each temperature. A constant number seems to be an obvious scheme. An alternative is to dynamically change this number as the algorithm progresses. At lower temperature, it is advisable to set a large value so that the local optimum can be fully explored. At higher temperatures, the number of iterations can be less.

In the current issue, the number of steps N_{steps} was set in connection to the number of possible harmonic filters $N_{filters}$ to connect to the grid, as given in (10):

$$N_{steps} = n \cdot (N_{filters} + 2) \quad (10)$$

where n is a suitably large integer ($n \cong 200$), defined to achieve the thermal equilibrium prior to a next temperature change.

3.2.2. Problem specific decision

Another set of decisions to make is specific to the problem to solve and is presented further below.

- Neighbourhood structure

When thinking about the problem of optimal filtering power sizing, the choice of the way to move from a current solution to another one is questioned. This means that a neighbourhood is to be defined. A relevant study is proposed in [23].

In the present application, the generator of random changes in the configuration is based on a varying neighbourhood as the algorithm progresses. The amplitude of the filtering current is then randomly selected in a solution space according to (11):

$$J_{hk}^j = \beta(T) \cdot J_{hk}^i \quad (11)$$

$$\left\{ \begin{array}{l} k = 1, \dots, N_{\text{nodes}} \\ i : \text{index of the current state} \\ j : \text{index of the new state} \\ \beta : \text{weight factor depending on the temperature parameter } T = T_v \text{ or } T_i \end{array} \right.$$

Consequently, as the temperature declines, the weight coefficient β is adjusted as a function of T_v or T_i depending on whether the SA process is applied to the harmonic voltages or to the filtering currents and the neighbourhood is gradually restricted, which ensures the success of the convergence process towards the expected global optimum.

- Cost function

Then, a cost function that models the current problem to solve is needed. As it will be calculated at every step of the algorithm, this objective function must be also easy and fast to calculate.

As the proposed algorithm (Figure 2) involves a double SA, a test procedure is systematically performed in order to assess whether or not the annealing process should be applied to the voltage or to the current according to the gap observed between the maximal nodal voltage newly calculated and the required limits. If the nodal voltage is thus more than the specified requirements, a voltage annealing is applied; conversely, if the standard is met, a current annealing is conducted. Then, the following stages of the algorithm are those of a conventional SA scheme like previously described in section 2.

In consequence, two distinctive objective functions can be referred depending on the nature of the SA process executed. When the problem shows no filtering solution, it means that no injected current goes to providing remedies for a reduction of the harmonic voltages below the standards. The objective is then specifically directed at decreasing as far as possible the nodal harmonic voltages to closely approximate the specified limits. Thus, the appropriate cost function (12) is defined as the standard deviation between the harmonic voltages and their threshold values over all the electrical system's nodes.

$$\min[\Delta v_h] = \min \left[\sqrt{\frac{1}{N} \cdot \sum_{k=1}^{N_{nodes}} (v_{hk} - v_{limit\ k})^2} \right] \quad (12)$$

Instead, when the voltage conditions are satisfied, the existence of a global optimum is clearly confirmed. The voltage annealing process is limited to the success of a local search which already guarantees a solution that works. Then, it automatically switches to a simulated current annealing which optimisation process is naturally applied to the harmonic currents injected by the filters connected to the grid. In that second instance, the objective is to minimise the total filtering current j_{total} that preserves the voltage requirements. The resultant cost function is therefore defined by (13) with respect to the constraint (14) on each nodal harmonic voltage v_{hk} . The returned value of the total filtering power is then minimal while the maximal nodal voltage meets the expected limits.

$$\min[j_{total}] = \min \left[\sum_{q \in ListFilter} |j_{hq}| \right] \quad (13)$$

$$v_{hk} \leq v_{limit\ k} \quad \forall k = 1, \dots, N_{nodes} \quad (14)$$

It can be appreciated that the minimum filtering power is obtained for the locations defined by the list of nodes (*ListFilter*) initially proposed. The optimal placement on the distribution network is then determined by testing all the possible combinations of the filters connections. In practice, the number of configurations is often small due to the limited number of busbars able to accept harmonic filters. As a result, an optimal process is not required to determine the 'best' configuration corresponding to the minimum value of the filtering power. Besides, the minimum power is not necessarily the best solution retained by an electrical engineer who must take into account many other technical and economical considerations. It seems then better to give the optimal solution for each configuration and to leave the engineer to select the best strategic choice afterwards.

4. Application to a ship power system

Tested on several real power systems, the above optimisation technique is presently implemented into a software package developed in C language. The example of an aboard ship power system is proposed further below so as to point out the benefit of the SA process to a very practical issue regarding harmonics and power quality in electrical systems.

4.1. Description of the power system

The electrical ship network of figure 3 is composed of six busbars with three voltage levels: 690V, 400V and 230V. Four 1.8MVA generators supply the 690V busbar (*TPF1*). The main powerful loads including the electric propulsion system are then connected directly to it. The propulsion system is made up of two variable speed drives (*MP_BD*, *MP_TD*) with a twelve-pulse structure. Five low voltage busbars, i.e. one 400V busbar on the port side and another one on the starboard side in addition with three 230V busbars, distribute the energy

everywhere aboard ship. According to their rated voltage, they supply the onboard equipment: two winches (*MT_BD*, *MT_TD*), the lighting system, several UPS units and battery chargers. Every load is modelled at each node by an equivalent linear impedance or by an equivalent source of current for the converters and the fluorescent lighting. The detailed specifications of the power system are given in the tables 8, 9, 10 of the appendix.

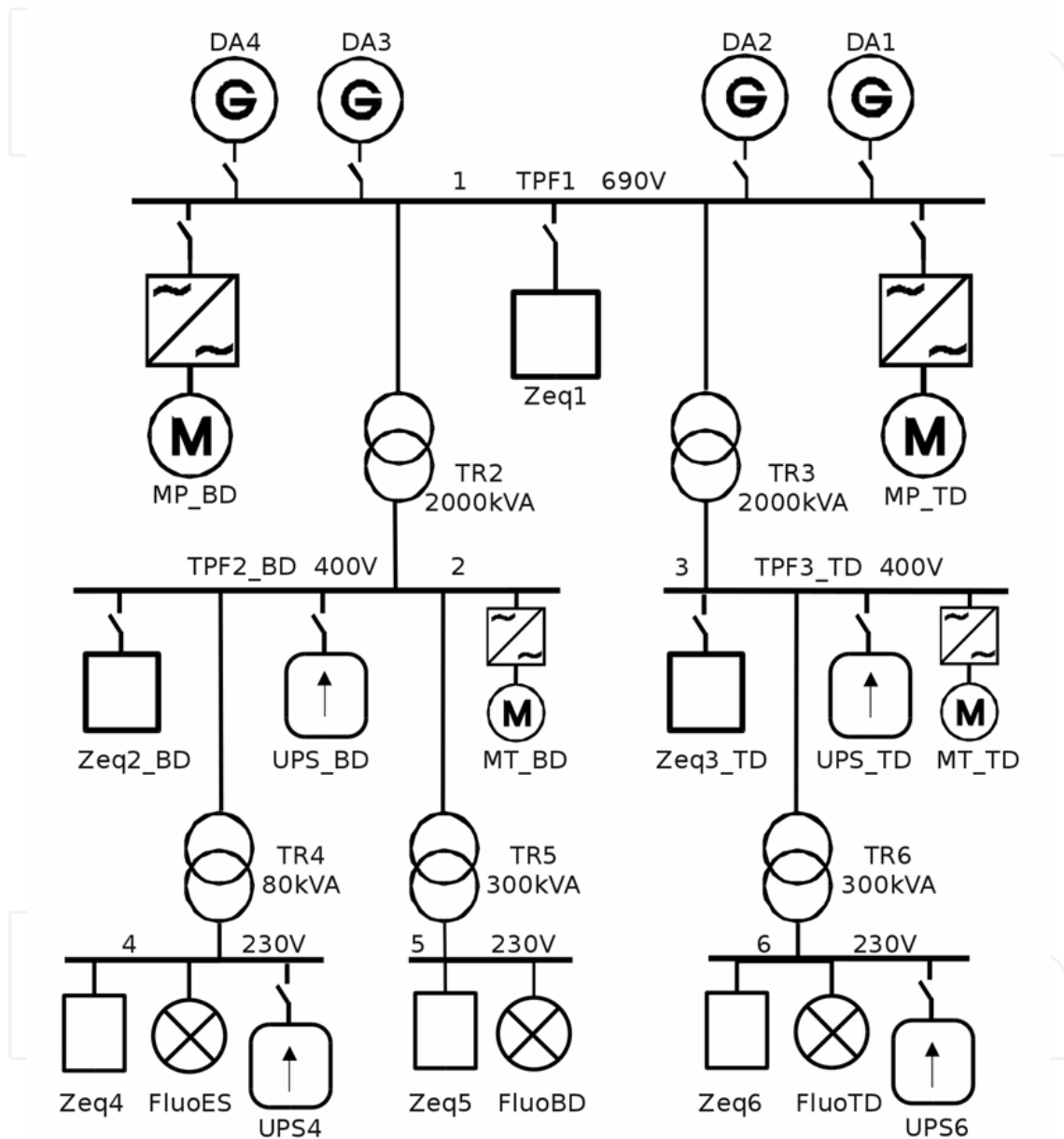

Figure 3. Single line diagram of the aboard ship network

The above-mentioned non linear loads inject harmonic currents in the network, which induces unfavourable resultant voltages. The IEC standard limits harmonic voltages according to the specifications given in the table 1. Nevertheless, the shipyard imposes even lower levels in order to guarantee a better power quality on the low voltage distribution system which might supply sensitive equipment.

harmonic order (h)	5	7	11	13
IEC – V_h (%)	6	5	3.5	3
shipyard - V_h (%) on 690V	3.5	3.5	3	3
shipyard - V_h (%) on 400V & 230V	3.5	3.5	1.2	1.2

Table 1. Harmonic voltage limits

n° busbar	1	2	3	4	5	6
$V_{h=11}$ (% V_n)	4.88	5.40	5.43	5.46	5.40	5.49

Table 2. Harmonic voltage: 11th order in configuration A

n° busbar	1	2	3	4	5	6
$V_{h=5}$ (% V_n)	3.28	3.74	3.88	4.59	4.06	5.41

Table 3. Harmonic voltage: 5th order in configuration B

4.2. Study statement

The two most stringent configurations will be presented and discussed further below. The first one relates to the study of the 11th harmonic order when the ship is travelling at full speed with three diesel engine generators running (configuration A). The second one involves the study of the fifth harmonic order when the ship is on berth with only one diesel engine generator operating (configuration B). Given the harmonic currents introduced by the non-linear loads of the electrical system as mentioned in the table 9 of the appendix, the simulation of the power system for the both configurations above shows the results of the table 2 and the table 3 respectively. It can be appreciated that the resulting voltage levels for the 11th harmonic order extend far beyond the limits set by the requirements. When simulating the harmonic voltages for the 5th order when the ship is in dock, the specified limits are not exceeded on the 690V busbar only. A filtering schedule is however required on the other busbars. The choice of the most suitable placement is then questioned: is it better to plan filtering on the 400V busbar or on the 230V busbar? The proposed optimisation procedure makes it possible to get answers to that critical question.

As displayed in figure 3, the electrical system shows six nodes and thus offers six possible placements for active or passive filters. With six possible locations, the number of filters can vary from one to six. A complete analysis to determine the most suitable placement(s) to select requires sixty-three case studies. With the support of the implemented software, all the combinations are examined in 9.3 seconds of CPU time with a personal computer fitted out with an Intel® CoreDuo T8100, 2.1GHz processor. Among the list of the possible filtering solutions, the most relevant ones will be presented and argued in the following section.

In order to ensure that the optimisation procedure works well, several variables have been saved at each temperature of the SA process as the search for the optimal solution moves forward. The progress of the filtering power and the nodal voltages is then reported at the end of the computation procedure in order to control the performance of the convergence towards the global optimal solution.

4.2.1. Eleventh harmonic order in the configuration A

- Filters on the 690V busbar

The present study considers a single filter connected to the main 690V busbar (*TPF1*), at the same location than the propulsion system injecting the greatest harmonic currents. The optimal filtering power provided by the proposed algorithm amounts to 158.9kVA, as mentioned in the table 4.

Filtering power (kVA)							Harmonic voltage (%V _n)					
1	2	3	4	5	6	total	1	2	3	4	5	6
158,9	-	-	-	-	-	158,9	0,39	0,93	0,93	1,20	0,97	1,20
15,0	50,4	44,1	-	-	-	109,5	1,79	0,93	1,10	1,20	0,97	1,20
143,1	-	-	0,8	1,2	2,0	147,1	0,67	1,20	1,20	1,03	0,99	0,90

Table 4. Filtering of the 11th harmonic order on the 690V busbar – Configuration A

It can be then noticed that the resultant harmonic voltage is very low at the filtering node whereas it becomes very close to the specified limits at the other nodes 4 and 6. The voltage requirements are however met at every busbar, even though the limit value of 1.2% is reached on the 230V busbars that are the farthest from the filter's location.

From the sixty-three possible combinations, thirty-two of them assume that one filter at least is to connect at *TPF1*. These solutions however offer different results according to the filtering nodes considered. For example, three filters connected to the 690V and 400V busbars require a lower total power of 109.5kVA as displayed in the table 4, with harmonic voltages at the nodes 4 and 6 still maintained within the specified limits. This solution is actually the best one. When considering another possible combination with harmonic filters on the 690V and 230V busbars respectively, the proposed solution shows a large filter to connect at *TPF1* in addition with smaller ones distributed on the three 230V busbars, in compliance with the harmonic voltages within the specified requirements of the table 1. Even though the total filtering power is slightly lower than that obtained with a single filter placed on the 690V busbar, common sense tell us that the global cost of the filtering system may be higher due to a minimum cost required by the placement of filters with their associated equipment such as cables and breakers. Then, the connection of too small filters might be no economically interesting.

Figure 4 indicates the progress of the main variables during the SA procedure. The graphs show a convergence of the voltage up to the fixed limit while the filtering power decreases towards an optimal value corresponding to the power distribution that minimises the total power. It must be however noticed that the filtering power represents only the magnitude of the current j_h that would be injected by an active filter. The variations of its phase angles which are not reported herein, could explain the greatest fluctuations of the harmonic voltages while power remains constant.

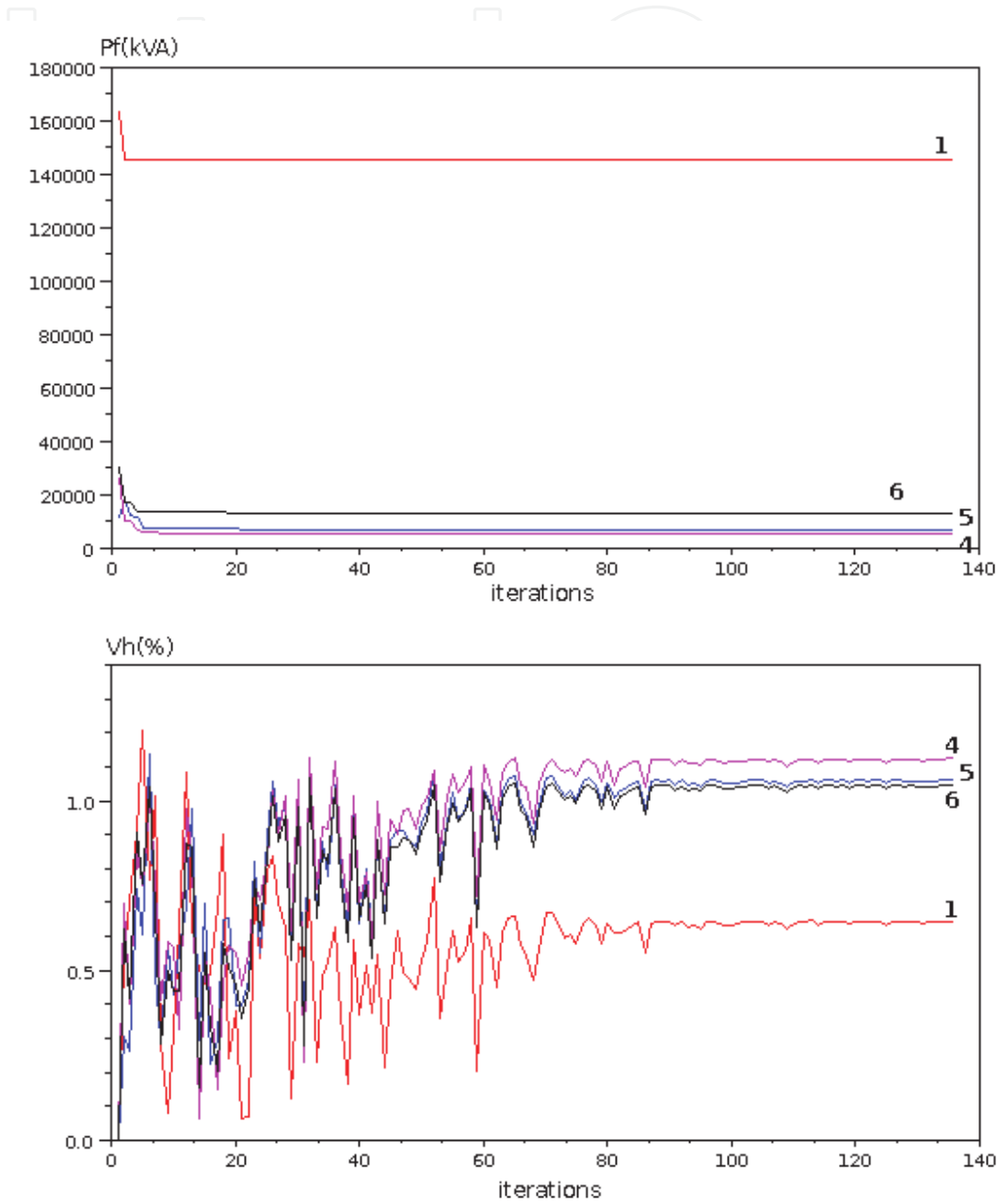

Figure 4. Filtering power and harmonic voltages – Combination {1,4,5,6} for h = 11 – (Conf. A)

- Filters on the 400V busbars

The second group of combinations presented below assumes that filters are placed on the 400V busbars together with some additional ones connected to the 230V busbars. The table 5 and Figure 5 show the resultant harmonic voltages and the filtering power progress during the optimisation procedure. When only one filter is connected to *TPF2* or *TPF3*, the specified limits on harmonic voltages cannot be respected. The optimisation procedure returns then the optimal power sizing associated with the lowest maximal harmonic voltage observed in the electrical system. An alternative is to place two filters on the both 400V busbars: then, the harmonic voltages are within the limit values, whatever the voltage levels throughout the electrical system. Compared with the placement of a single filter on the 690V busbar (*TPF1*):

- the convergence is achieved with a lower total power of 104.6kVA,
- the resultant voltage on the 690V is higher but remains below the requirements,
- the harmonic voltages on the 230V busbars at nodes 4 and 6, reach the limit of 1.2%.

When filtering the 230V busbar (node 4 or 6) in addition with the both 400V busbars, the results compared with the previous one do not change significantly regarding the total power. Only the distribution of the maximal harmonic voltages is different according to the nodes. Besides, when only one filter is connected to the 400V busbar (*TPF2* or *TPF3*) and several smaller ones to the 230V, the voltage limit observed on the 400V busbar with no filter is exceeded. It can be however noted in Figure 5 the progress in reducing the involved harmonic voltages. Initially, when the annealing temperature is high, some large increases in the harmonic voltages are accepted and some areas far from the optimum are explored. As execution continues and the temperature falls, fewer uphill excursions are tolerated with smaller magnitude. This performance is typical of the SA algorithm. Even if the voltage amplitudes remain greater than the specified limits, the returned values are the best expected ones.

Filtering power (kVA)							Harmonic voltage (%V _n)					
1	2	3	4	5	6	total	1	2	3	4	5	6
-	114,5	-	-	-	-	114,5	1.66	1.40	2.25	1.03	1.34	2.34
-	-	119,5	-	-	-	119,5	1.51	2.11	1.49	2.34	2.14	1.35
-	55,1	49,5	-	-	-	104,6	1.94	0.92	1.10	1.20	0.96	1.20
-	49,7	51,9	0,3	-	-	101,9	2.02	1.16	1.10	1.20	1.19	1.20
-	56,6	46,0	-	-	0,7	103,3	1.98	0.93	1.20	1.20	0.97	1.16
-	73,6	-	3,0	-	17,8	94,4	2.37	1.21	2.44	1.20	1.23	1.35

Table 5. Filtering of the 11th harmonic order on the 400V busbar – Configuration A

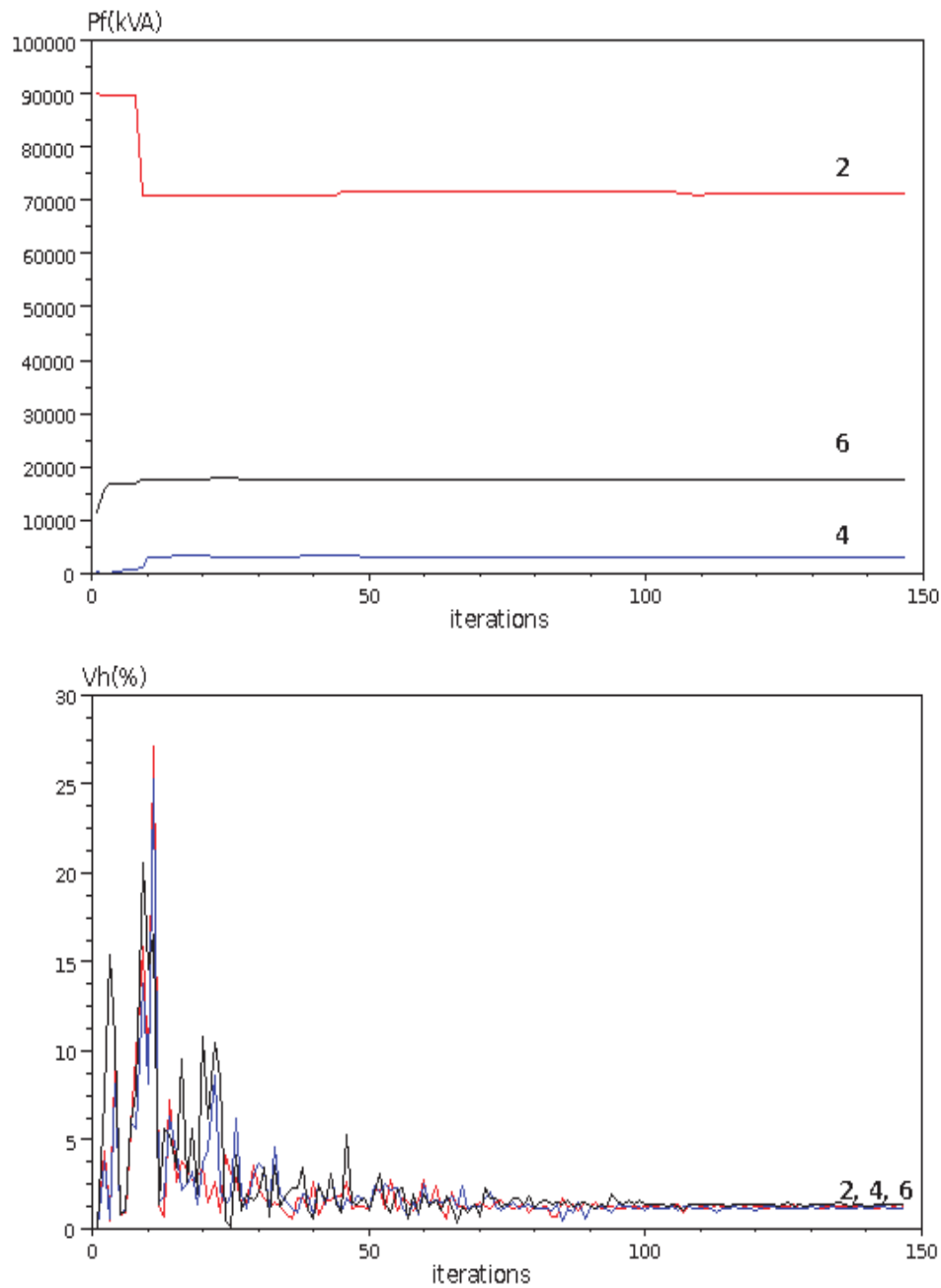

Figure 5. Filtering power and harmonic voltages – Combination {2,4,6} for $h = 11$ - (Conf. A)

- Filters on the 230V busbars

The analysis of the combinations involving one, two or three harmonic filters on the 230V busbars as displayed in the table 6, leads to the same conclusion: whatever the number of filters connected, none of the proposed solutions are able to fit the harmonic voltage requirements. It can be however noticed that a filtering solution on the 230V busbars could be considered if the harmonic voltage limits were less severe. For example, the table 6 shows that the combination of three filters connected to the nodes 4, 5, 6 respectively could meet the requirements set by the IEC Standard (i.e. 3.5% for $h=11$).

- Concluding remarks

Among the different solutions discussed above for the configuration A, the optimal filtering solution that offers a minimal total power is achieved with three filters, connected to the nodes 2, 3, 4 respectively, as shown in Figure 6. However, when thinking about some other considerations like the cost involved by the connection of an additional filter (outputs, protecting devices, etc...), the decision to make can be greatly influenced. Then, a comparison with the gain offered on the total filtering power and the power quality of the electrical system would be worthwhile considering.

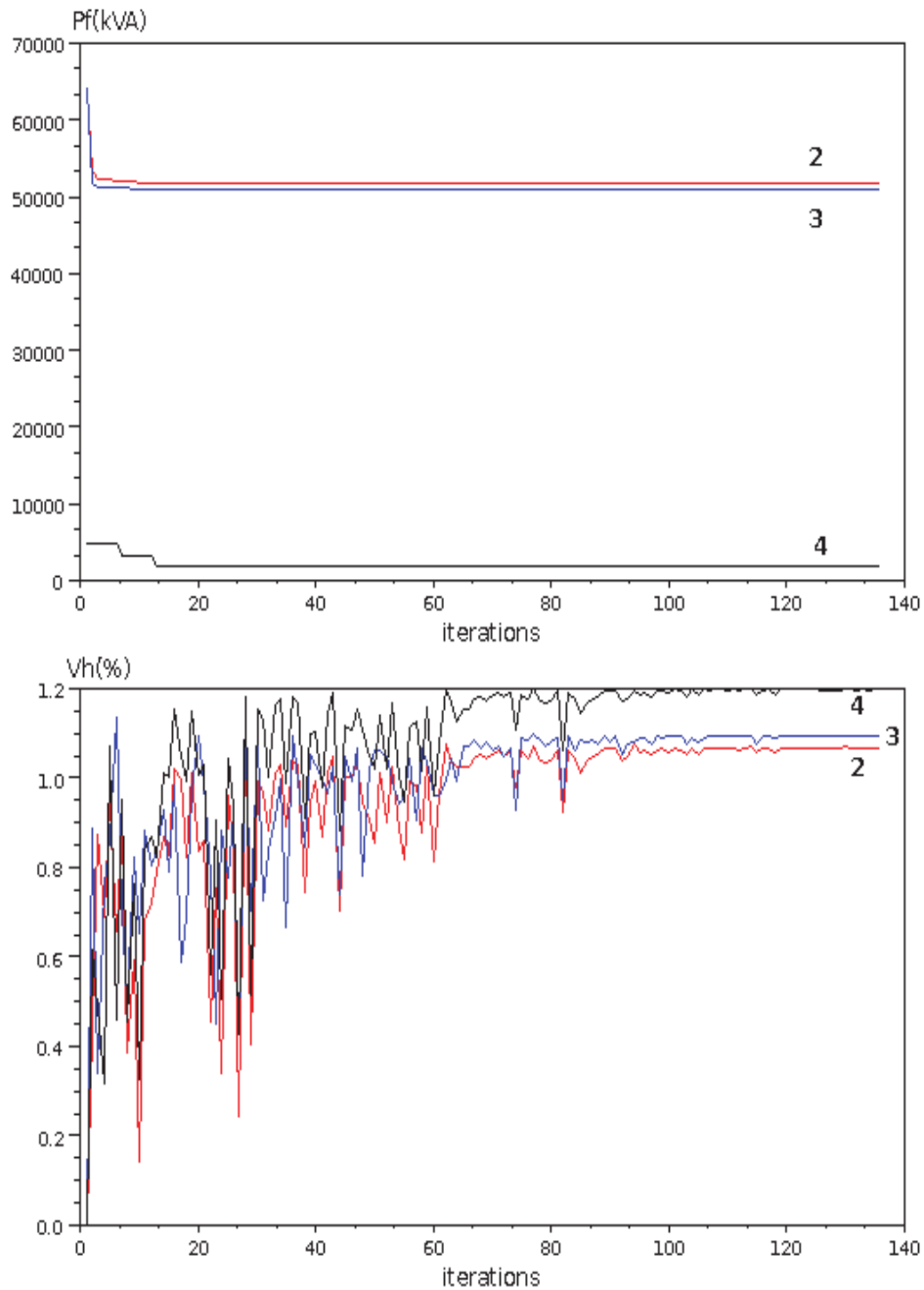

Figure 6. Filtering power and harmonic voltages – Combination {2,3,4} for $h = 11$ - (Conf. A)

Filtering power (kVA)							Harmonic voltage (%V _n)					
1	2	3	4	5	6	total	1	2	3	4	5	6
-	-	-	9,4	-	-	9,4	4.66	4.93	5.21	2.04	4.93	5.28
-	-	-	-	30,4	-	30,4	4.08	3.73	4.64	3.88	3.02	4.72
-	-	-	-	-	29,9	29,9	4.08	4.62	3.76	4.72	4.63	2.82
-	-	-	6,5	22,7	23,9	53,1	3.50	3.22	3.38	1.36	1.76	1.79

Table 6. Filtering of the 11th harmonic order on the 230V busbar – Configuration A

4.2.2. Fifth harmonic order in the configuration B

- Filters on the 690V / 400V / 230V busbars

Except in the situation where only one filter is located at the node 4 or 5 (230V), every other filters combination allows to meet the harmonic voltage specifications. The table 7 and Figure 7 illustrate the main results for the new configuration. Nevertheless, it can be noted that the filtering power can vary greatly in a ratio from 1 to 4 according to the selected connection point. Then the maximum power level near to 51kVA is achieved with a filter connected to the node 1 or 2 while the minimum value of 14.5kVA is obtained with a filtering applied to the nodes 4 and 6.

The proper working of the optimisation process can be then appreciated: the implemented procedure allows to assess a suitable filtering power in compliance with the specified limits set to 3.5% for the fifth harmonic while minimising the total power involved. This also highlights the interest to search for the optimal number and placement of harmonic filters to connect to the grid. In the proposed example, the placement of two filters at the nodes 4 and 6 allows to solve the matter whereas a single filter connected to the node 4 cannot meet the voltage requirements for a similar filtering power near to 14 kVA.

5. Conclusion

This chapter deals with a new technique to optimise the both placement and sizing of the harmonic filters to connect to a distribution system. Then, the problem is solved by a combinatorial optimisation method using successively two SA processes. The objective is to reduce the harmonic voltages with respect to the standards and to achieve a minimum power size in view of maximum savings in the equipment cost.

The optimisation technique has been implemented into a software package and tested on several real power systems. The tables of results giving information about the optimal filtering power and the resultant harmonic voltages allow fast comparisons between numerous configurations.

Filtering power (kVA)							Harmonic voltage (%V _n)					
1	2	3	4	5	6	total	1	2	3	4	5	6
50,7	-	-	-	-	-	50,7	1.41	1.86	1.98	2.71	2.17	3.50
	51,1					51,1	1.41	1.34	1.98	2.10	1.61	3.50
-	-	37,9	-	-	-	37,9	1.85	2.32	1.98	3.19	2.65	3.50
-	2,2	36,3	-	-	-	38,5	1.83	2.28	1.98	3.14	2.60	3.50
-	-	37,4	0,7	-	-	38,1	1.85	2.31	1.98	2.98	2.63	3.50
-	-	-	13,5	-	-	13,5	2.81	3.13	3.40	3.53	3.45	4.92
-	-	-	-	-	29,6	29,6	2.18	2.64	2.42	3.50	2.96	1.79
-	-	-	1,9	-	12,6	14,5	2.73	3.17	3.17	3.44	3.50	3.50
-	0,7	0,6	1,6	-	12,1	15	2.72	3.16	3.15	3.50	3.49	3.50

Table 7. Filtering of the 5th harmonic order on the 690V/400V/230V busbar – Configuration B

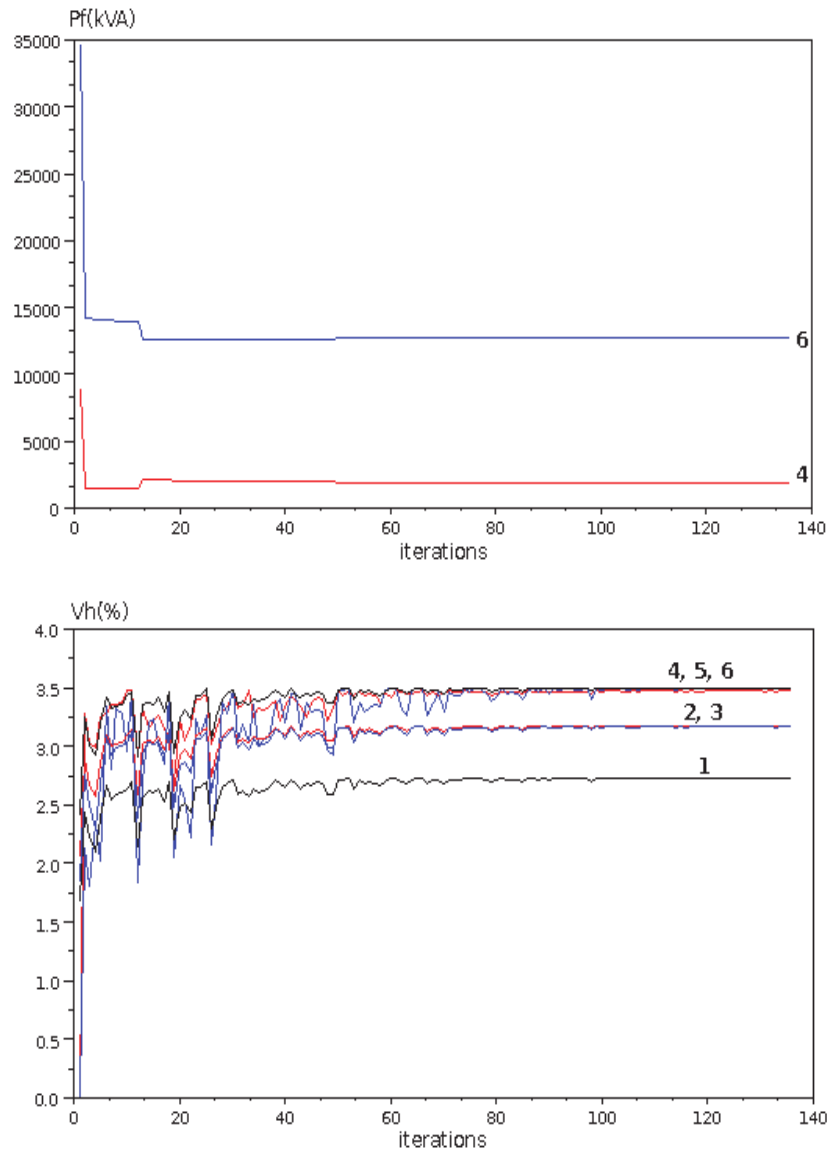

Figure 7. Filtering power and harmonic voltages – Combination {4,6} for h = 5 - (Conf. B)

The analysis of every one can provide several equivalent solutions in terms of total power but shows different voltage distributions. The practical cases discussed in this chapter conclude that for a similar filtering power, some other practical considerations like the minimum cost of the filter installation, the available place aboard ship, the expected power quality at the moment and the further system evolution, must also be taken into account so that the best solution can be suitably identified.

Consequently, the optimisation method associated with the implemented software must be considered as an interesting support for the engineer in charge of the placement of harmonic filters onto the grid. Also given practical purposes, the use of the calculation tool should make easier the harmonic filters sizing and provide a good starting point to make the right decision in terms of filtering solutions. Improvements of power quality together with the optimisation of the power to install in electrical distribution systems are today a critical challenge that deserves our undivided attention.

Appendix

The specifications of the power system described in figure 3 are summarised in the following table 8 and table 10. The impedance of the cables is neglected due to their small length. The harmonic analysis is achieved from the currents injected by the non linear loads given in the table 9.

ref.	U_n (V)	P (kW)	Q (kvar)
<i>Zeq1</i>	690	160	126
<i>Zeq2_BD</i>	400	315	237
<i>Zeq3_TD</i>	400	300	225
<i>Zeq4</i>	230	56	#0
<i>Zeq5</i>	230	40	#0
<i>Zeq6</i>	230	56	#0
<i>DA1-DA3</i>	690	1180	11800 (Scc)
<i>DA4</i>	690	OFF	OFF

Table 8. Linear load parameters

order h $I_{rms}(A)$	5	7	11	13
<i>MP_BD</i>	0	0	53.7	38.8
<i>MP_TD</i>	0	0	53.7	38.8
<i>MT_BD</i>	46.5	24.7	14.4	9.75
<i>MT_TD</i>	46.5	24.7	14.4	9.75
<i>UPS_BD</i>	30.2	18.6	15.2	9.3
<i>UPS_TD</i>	30.2	18.6	15.2	9.3
<i>Fluo_ES</i>	5.4	0.8	0.4	0.4
<i>UPS4</i>	1.6	1.0	0.8	0.5
<i>Fluo_BD</i>	8.9	1.3	0.6	0.6
<i>Fluo_TB</i>	8.9	1.3	0.6	0.6
<i>UPS6</i>	1.6	1.0	0.8	0.5

Table 9. Harmonic currents (A) injected by the non linear loads of the power system

ref.	U_{1n} (V)	U_{2n} (V)	S_n (kVA)	u_{cc} (%)
<i>TR3</i>	690	400	2000	5.5
<i>TR4</i>	690	400	2000	5.5
<i>TR5</i>	400	230	300	6
<i>TR6</i>	400	230	300	6
<i>TR8</i>	400	230	80	5.5

Table 10. Parameters of the power transformers

Author details

Laurence Miègeville

*Department of Electrical Engineering, POLYTECH Nantes, University of Nantes, France
Research Institute on Electrical Energy of Nantes Atlantique, St Nazaire, France*

Patrick Guérin

*Department of Industrial Engineering and Maintenance,
IUT Saint-Nazaire, University of Nantes, France
Research Institute on Electrical Energy of Nantes Atlantique, St Nazaire, France*

6. References

- [1] Grainger J.J., Lee S.H (1981) Optimal size and location of shunt capacitors for reduction of losses in distribution feeders. IEEE Trans. on Power Application System, vol. PAS-100, pp. 1105-1118.
- [2] Wu Z.Q, Lo K.L (1995) Optimal choice of fixed and switched capacitors in radial distributors with distorted substation voltage. IEE Proc. Generation Transmission Distribution, Vol. 142, n° 1, pp 24-28.

- [3] Saric A.T, Calovic M.S, Djukanovic M.B (1997) Fuzzy optimisation of capacitors in distribution systems. IEE Proc. Generation Transmission Distribution, Vol. 144, n° 5, pp 415-422.
- [4] Chiang H.D, Wang J.C, Darling G (1995) Optimal capacitor placement, replacement and control in large-scale unbalanced distribution systems. IEEE Trans. on Power Systems, Vol.10, n°1, pp 356 - 362.
- [5] Masoum M.A.S, Ladjevardi M, Jafarian A, Fuchs E.F (2004) Optimal placement, replacement and sizing of capacitor banks in distorted distribution networks by genetic algorithms. IEEE Trans. on Power Delivery, vol. 19, n°4, pp. 1794-1801.
- [6] Dai X, Gretsch R (1994) Optimal compensator currents for the reduction of the harmonic distortion in networks, Part 1: analytic solution, Part 2: graphic solution. ETEP, Vol. 4, n°4, pp 301-307, pp 309-313.
- [7] Guérin P, Miègeville L, Bizien A (1999) Optimal placement and size of a single harmonic filter. In: 8th European Conference on Power Electronics and Applications, Lausanne, Switzerland, Session D3.7.
- [8] Chang G.W, Chu S.Y, Wang H.L (2002) A new approach for placement of single-tuned passive harmonic filters in a power system. IEEE Power Engineering Society Transmission and Distribution Conference, vol. 2, issue Summer, pp. 814-817.
- [9] Mikolajuk K (1996) The problem of harmonic compensators location. ETEP, Vol. 6, n°6, pp 397-400.
- [10] Guérin P, Miègeville L (2007) Optimal Placement and Sizing of Harmonic Filters Aboard an Electric Propulsion Ship. IET Generation, Transmission and Distribution, Vol. 1, Issue 4. pp. 613-618.
- [11] Metropolis N, Rosenbluth A.W, Rosenbluth M.N, Teller A.H, Teller E (1953) Equation of state calculation by fast computing machines. Journal of Chemical Physics, n°21, pp 1087-1091.
- [12] [12] Kirkpatrick S, Gelatt C.D, Vecchi M.P (1983) Optimization by simulated annealing. Science, Vol. 220, n°4598, pp 671-680.
- [13] Dowsland K.A (1995) Simulated annealing in modern heuristic techniques for combinatorial problems (ed. Reeves, C.R.). McGraw-Hill.
- [14] [14] Arrillaga J, Arnold C.P, Harker B.J (1983) Computer modelling of electrical power systems. John Wiley & Sons, ISBN 047110406X.
- [15] [15] Shojaee K, Shakouri G, Behnam Taghadosi M (2010) Importance of the initial conditions and the time schedule in the Simulated Annealing. Publisher Sciyo, Simulated Annealing, Theory with Applications 292 p. ISBN 978-953-307-134-3. pp 217-224.
- [16] Hajek B (1988) Cooling Schedules for Optimal Annealing. Mathematics of Operations Research, vol. 13, n°2, pp 311-329.
- [17] Huang MD, Romeo F, Sangiovanni-Vincentelli A (1986) An efficient general cooling schedule for simulated annealing. Proceedings of the IEEE International Conference on Computer Aided Design, Santa Clara, USA, pp 381-384.

- [18] Thompson J, Dowsland KA (1995) General cooling schedules for a simulated annealing based timetabling system. Proceedings of the first International Conference on the practice and Theory of Automated timetabling, Napier University, Edinburgh.
- [19] Azizi N, Zolfaghari S (2004) Adaptive temperature control for simulated annealing: a comparative study. *Computer & Operations Research*, Elsevier, n°31, pp 2439-2451.
- [20] Stander J, Silverman B (1994) Temperature schedules for simulated annealing. *Statistics and Computing*, 4, pp 21-32.
- [21] Lin C.K.Y, Haley K.B, Sparks C (1995) A comparative study of both standard and adaptive versions of threshold accepting and simulated annealing algorithms in three scheduling problems. *European Journal of Operational Research*, 83, pp 330-346.
- [22] Nourani Y, Andresen B (1998) A comparison of simulated annealing cooling strategies. *Journal Phys. Math. Gen.* N°31, pp 8373-8385.
- [23] Alizamir S, Rebennack S, Pardalos P.M (2008) Improving the neighbourhood selection strategy in Simulated Annealing using the optimisation stopping problem. Publisher InTech, *Simulated Annealing* 420 p. ISBN 978-953-7619-07-7, pp 363-382.