

We are IntechOpen, the world's leading publisher of Open Access books Built by scientists, for scientists

5,500

Open access books available

136,000

International authors and editors

170M

Downloads

Our authors are among the

154

Countries delivered to

TOP 1%

most cited scientists

12.2%

Contributors from top 500 universities



WEB OF SCIENCE™

Selection of our books indexed in the Book Citation Index
in Web of Science™ Core Collection (BKCI)

Interested in publishing with us?
Contact book.department@intechopen.com

Numbers displayed above are based on latest data collected.
For more information visit www.intechopen.com



Hierarchical Fuzzy Control

Carlos André Guerra Fonseca, Fábio Meneghetti Ugulino de Araújo
and Marconi Câmara Rodrigues

Additional information is available at the end of the chapter

<http://dx.doi.org/10.5772/48627>

1. Introduction

Growing demands for comfort, reliability, accuracy, energy conservation, safety and economy have fueled interest in proposals that can contribute to facilitate high performance control systems design. In terms of vibrations active control, it may represent, for example, a good relationship between the maximum reduction in vibrations transmission between two systems and the minimum energy expended in order to accomplish this reduction [1].

The use of more than one controller to provide higher performance for complex systems has attracted interest because in each operation condition, their combination can take advantage of each controller's characteristics. To take advantage of controllers' combination, a supervisor can make a hierarchical classification of controllers' signals, according to the identified operational condition.

Advances in artificial intelligence, processing power and data storage, allowed the development of intelligent methods for different characteristics controllers' fusion. The use of intelligent methods allows to the controlled system: adaptability to various operational situations and proper performance, even in the presence of significant uncertainties. Intelligent supervisors are ease to maintain, to reconfigure and could have optimality during its operation according to the learning mechanism.

This chapter describes a methodology for controllers' combination called controllers hierarchical fusion. In this methodology, a supervisor system is used to obtain a single control signal from the control signals generated simultaneously by two or more controllers. A hierarchical controller's example compounded by one robust controller, one fuzzy controller and one fuzzy supervisor is applied for mechanical vibrations isolation and reference tracking using an electromechanical system proposed in [2]. This controller is called hierarchical fuzzy controller (HFC).

This electromechanical system can be used to eliminate vibrations in the camera of unmanned vehicles and also to position this camera. It can also be used in manned vehicles for drivers' seat positioning and to eliminate vibrations on it, as shown in Figure 1.

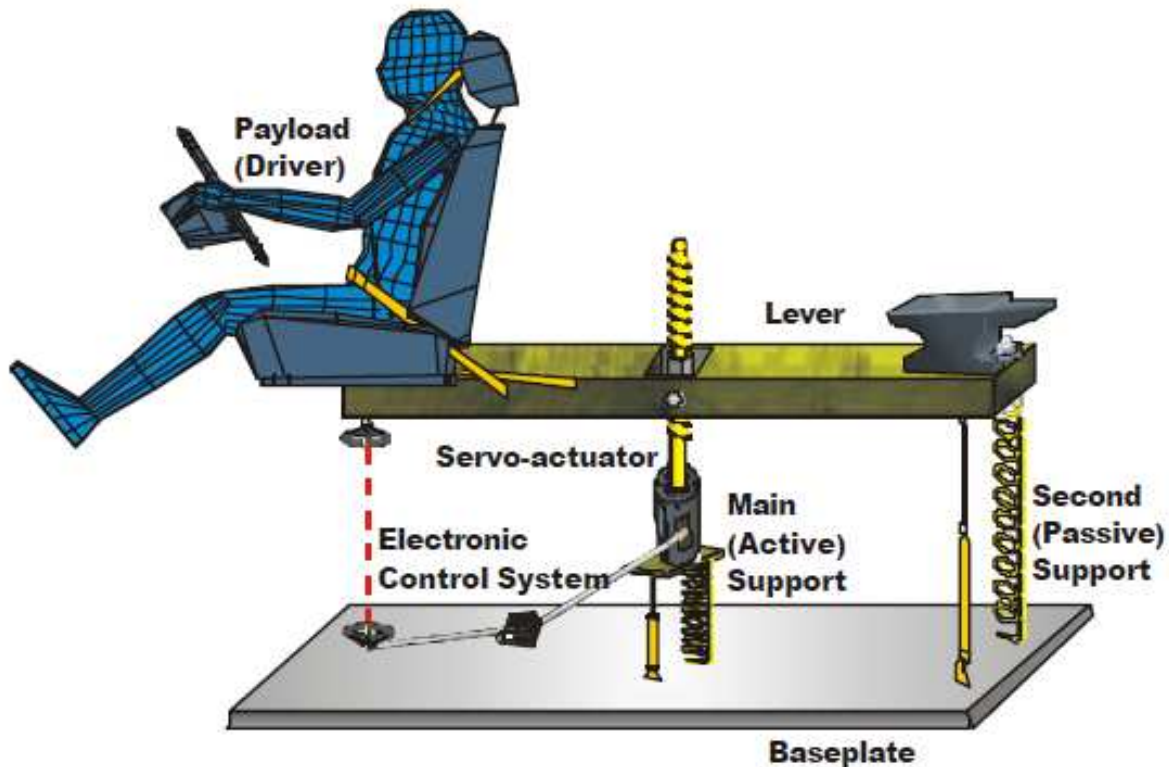

Figure 1. Application example: active suspension system

Digital simulations are employed in two case studies and the results are compared. On the first case study, the fuzzy controller and the fuzzy supervisor are tuned manually. Genetic algorithms (GA) are used on those systems tuning, in the second case study. Genetic algorithms usage facilitates designer's task and allows tuning parameters' optimization.

Next session describes the electromechanical system used and presents its models developed in [1]. The nonlinear model is used to validate the hierarchical fuzzy controller and in its fuzzy components' tuning, while the linearized model is used for robust control design. Performance criteria's are established at the end of this section.

2. Electromechanical system

Figure 2 details the electromechanical system used for vibration suppression and reference tracking. It consists on an l centimeters long bar with J inertia angular moment. It is considered that its mass m_B , is concentrated in its geometric center. This bar works as a lever which is supported in two points by systems with stiffness and damping, given by: k_A, k_B, c_A, c_B . In one extremity of the bar, a mass, m_A , called absorbing mass, is used to make a counterbalance with the payload. The payload is represented by a mass, m_C , on bar's free end. This system part is purely mechanical, being called lever system.

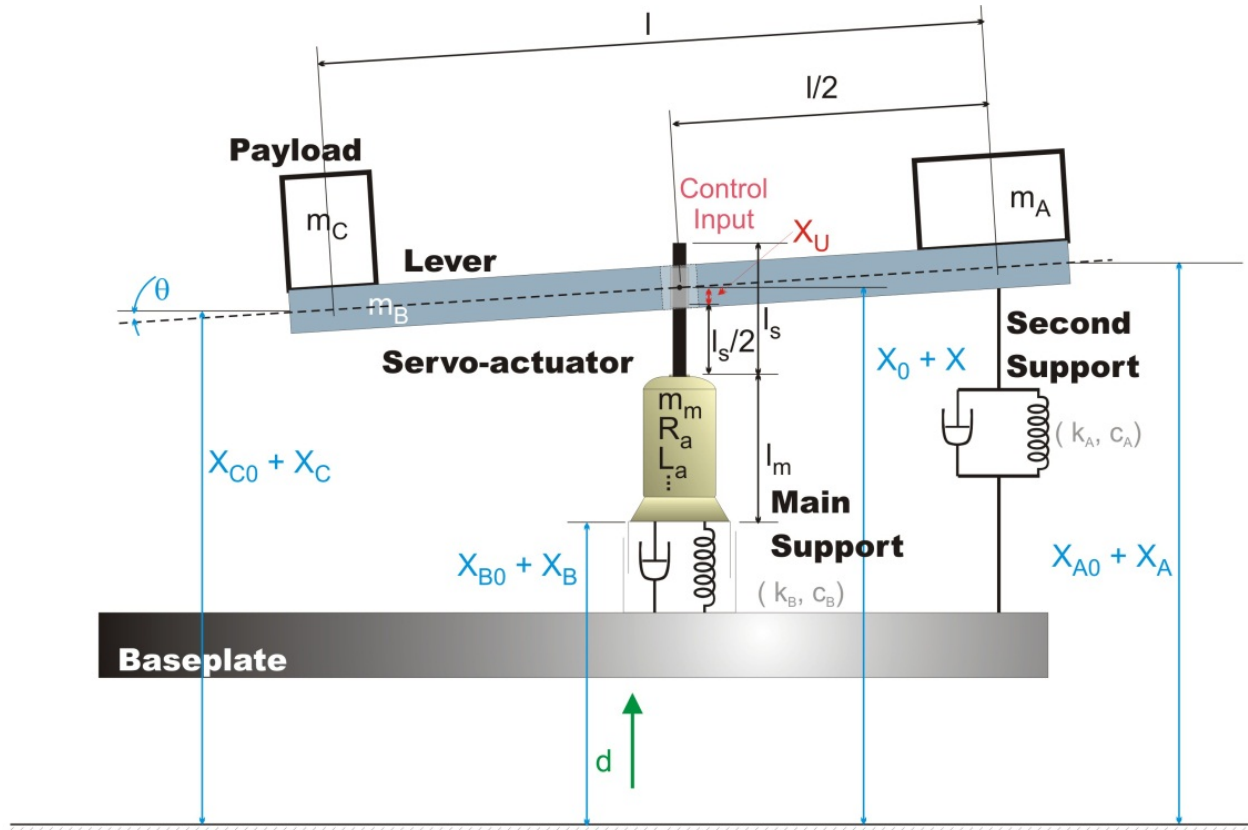

Figure 2. Electromechanical system

The vertical position control of bar's center is made by a servo actuator. This actuator consists of a DC servo motor whose axis is directly coupled to a spindle. The propeller's spindle step is given by L_p . It represents the direct relationship between motor's rotation angle (θ_M) and control's vertical displacement (X_u) imposed to bar's center with reference to the motor position (X_B).

The servo actuator varies the vertical position of bar's center depending on the measured displacements on bar's free end. This is done to isolate the payload from vibrations originated at the base.

A sensor that converts movements into voltage is used to measure vibrations on the payload. Those voltages feed servo motor, thus closing the control loop. Controllers are used to improve control efficiency, reaching thus performance specifications previously determined. This subsystem composed by one (or more) sensors, controllers and a servo-actuator, is called control system.

The nonlinear model used was developed in [1]. For the lever system it was given by:

$$\begin{aligned} \dot{\mathbf{x}} &= \mathbf{f}(\mathbf{x}(t), \mathbf{u}(t), t) \\ y &= g(\mathbf{x}(t), t) = q_1 - \frac{l}{2} \text{sen}(q_2) \end{aligned} \quad (1)$$

Where:

$$\mathbf{x}(t) = \begin{bmatrix} q_1 \\ \dot{q}_1 \\ q_2 \\ \dot{q}_2 \end{bmatrix}; \quad \mathbf{u}(t) = \begin{bmatrix} x_u \\ d \end{bmatrix}; \quad (2)$$

And:

$$\mathbf{f}(\mathbf{x}(t), \mathbf{u}(t), t) = \begin{bmatrix} \dot{q}_1 \\ \frac{-k_2(T_{11} + T_{12}) + k_1 \cos(q_2)(T_{21} + T_{22})}{T_D} \\ \dot{q}_2 \\ \frac{-m(T_{21} + T_{22}) + k_1 \cos(q_2)(T_{11} + T_{12})}{T_D} \end{bmatrix} \quad (3)$$

With:

$$k_1 = \frac{l}{2}(m_A - m_C) \quad (4)$$

$$k_2 = \left(\frac{l}{2}\right)^2 (m_A + m_C) + \frac{1}{12} m_B (a^2 + l^2) \quad (5)$$

$$T_{11} = (k_A \delta_A + k_B \delta_B - mg) - \frac{1}{8} k_A (8q_1 + 4l \text{sen}(q_2) - 8d) - lk_B (q_1 - x_U - d) - c_B (\dot{q}_1 - \dot{x}_U - \dot{d}) + k_1 \dot{q}_2^2 \text{sen}(q_2) + m_m \bar{x}_u \quad (6)$$

$$T_{12} = -\frac{\frac{1}{16} c_A (8q_1 + 4l \text{sen}(q_2) - 8d)}{4\left(q_1 + \frac{l}{2} \text{sen}(q_2) - d\right)^2 + l^2 (1 - \cos(q_2))^2} \quad (7)$$

$$T_{21} = \frac{l}{2}(m_A - m_C)g - \frac{1}{8} k_A \left[4\left(q_1 + \frac{l}{2} \text{sen}(q_2) - d\right) l \cos(q_2) + 2l^2 (1 - \cos(q_2)) \text{sen}(q_2) \right] \quad (8)$$

$$T_{22} = -\frac{\frac{1}{16} c_A \left[4\left(q_1 + \frac{l}{2} \text{sen}(q_2) - d\right) l \cos(q_2) + 2l^2 (1 - \cos(q_2)) \text{sen}(q_2) \right]}{4\left(q_1 + \frac{l}{2} \text{sen}(q_2) - d\right)^2 + l^2 (1 - \cos(q_2))^2} \quad (9)$$

$$\left[8\left(\dot{q}_1 + \frac{l}{2} \dot{q}_2 \cos(q_2) - \dot{d}\right)\left(q_1 + \frac{l}{2} \text{sen}(q_2) - d\right) + 2l^2 \dot{q}_2 \text{sen}(q_2) (1 - \cos(q_2)) \right]$$

$$T_D = -k_2 m + (k_1 \cos(q_2))^2 \quad (10)$$

The equation that describes servo actuator dynamics is given by:

$$\ddot{x}_u + \frac{1}{T_m} \dot{x}_u = \frac{L_p K_m}{T_m} e_a \quad (11)$$

For robust control project it was used the linearized model founded in [1].

$$\begin{bmatrix} \dot{x}_1 \\ \dot{x}_2 \\ \dot{x}_3 \\ \dot{x}_4 \\ \dot{x}_5 \\ \dot{x}_6 \end{bmatrix} = \begin{bmatrix} 0 & 1 & 0 & 0 & 0 & 0 \\ -a_1^{12} & -a_1^{11} & -a_2^{12} & -a_2^{11} & -a_3^{12} & -a_3^{11} \\ 0 & 0 & 0 & 1 & 0 & 0 \\ -a_1^{22} & -a_1^{21} & -a_2^{22} & -a_2^{21} & -a_3^{22} & -a_3^{21} \\ 0 & 0 & 0 & 0 & 0 & 1 \\ 0 & 0 & 0 & 0 & 0 & -a_3^{31} \end{bmatrix} \cdot \begin{bmatrix} x_1 \\ x_2 \\ x_3 \\ x_4 \\ x_5 \\ x_6 \end{bmatrix} + \begin{bmatrix} 0 & \beta_2^{11} \\ \beta_1^{12} & \beta_2^{12} \\ 0 & \beta_2^{21} \\ \beta_1^{22} & \beta_2^{22} \\ 0 & 0 \\ \beta_1^{32} & 0 \end{bmatrix} \cdot \begin{bmatrix} e_a \\ d \end{bmatrix} \quad (12)$$

$$y = x_c = \begin{bmatrix} 1 & 0 & -\frac{l}{2} & 0 & 0 & 0 \end{bmatrix} \cdot \begin{bmatrix} x_1 \\ x_2 \\ x_3 \\ x_4 \\ x_5 \\ x_6 \end{bmatrix}$$

The system states are:

$$x_1 = q_1 = x, x_2 = \dot{q}_1 - \beta_2^{11} d = \dot{x} - \beta_2^{11} d, x_3 = q_2 = \theta, x_4 = \dot{q}_2 - \beta_2^{21} d = \dot{\theta} - \beta_2^{21} d, x_5 = \theta_m, x_6 = \dot{\theta}_m \quad (13)$$

Where:

$$\begin{aligned} \beta_1^{12} &= b_1^{12}, \beta_1^{22} = b_1^{22}, \beta_1^{32} = b_1^{32}, \beta_2^{11} = b_2^{11}, \beta_2^{21} = b_2^{21}, \beta_2^{12} = b_2^{12} - a_1^{11} b_2^{11} - a_2^{11} b_2^{21}, \\ \beta_2^{22} &= b_2^{22} - a_1^{21} b_2^{11} - a_2^{21} b_2^{21} \end{aligned} \quad (14)$$

The coefficients a_i^{jk} and b_i^{jk} are given by:

$$\begin{aligned} a_1^{11} &= -CL_{11}, a_1^{12} = -CL_{12}, a_2^{11} = -CL_{13}, a_2^{12} = -CL_{14}, a_3^{11} = -L_p CL_{18} + \frac{L_p CL_{17}}{T_m}, \\ a_3^{12} &= -L_p CL_{19}, a_1^{21} = -CL_{21}, a_1^{22} = -CL_{22}, a_2^{21} = -CL_{23}, a_2^{22} = -CL_{24}, \\ a_3^{21} &= -L_p CL_{28} + \frac{L_p CL_{27}}{T_m}, a_3^{22} = -L_p CL_{29}, a_3^{31} = \frac{1}{T_m} \end{aligned} \quad (15)$$

And:

$$b_1^{12} = \frac{L_P K_m CL_{17}}{T_m}, b_2^{11} = CL_{15}, b_2^{12} = CL_{16}, b_1^{22} = \frac{L_P K_m CL_{27}}{T_m}, b_2^{21} = CL_{25}, b_2^{22} = CL_{26}$$

$$b_1^{32} = \frac{K_m}{T_m}$$
(16)

Where:

$$CL_{11} = \frac{-k_2(-c_a - c_b) - \frac{l}{2}k_1c_a}{-k_2m + k_1^2}$$
(17)

$$CL_{12} = \frac{-k_2(-k_a - lk_b) - \frac{l}{2}k_1k_a}{-k_2m + k_1^2}$$
(18)

$$CL_{13} = \frac{\frac{l}{2}k_2c_a - \left(\frac{l}{2}\right)^2 k_1c_a}{-k_2m + k_1^2}$$
(19)

$$CL_{14} = \frac{\frac{l}{2}k_2k_a - \left(\frac{l}{2}\right)^2 k_1k_a}{-k_2m + k_1^2}$$
(20)

$$CL_{15} = \frac{-k_2(c_a + c_b) + \frac{l}{2}k_1c_a}{-k_2m + k_1^2}$$
(21)

$$CL_{16} = \frac{-k_2(k_a + lk_b) + \frac{l}{2}k_1k_a}{-k_2m + k_1^2}$$
(22)

$$CL_{17} = \frac{-k_2m_m}{-k_2m + k_1^2}$$
(23)

$$CL_{18} = \frac{-k_2c_b}{-k_2m + k_1^2}$$
(24)

$$CL_{19} = \frac{-k_2lk_b}{-k_2m + k_1^2}$$
(25)

$$CL_{21} = \frac{\frac{l}{2}mc_a + k_1(-c_a - c_b)}{-k_2m + k_1^2}$$
(26)

$$CL_{22} = \frac{\frac{l}{2}mk_a + k_1(-k_a - lk_b)}{-k_2m + k_1^2} \quad (27)$$

$$CL_{23} = \frac{\left(\frac{l}{2}\right)^2 mc_a - \frac{l}{2}k_1c_a}{-k_2m + k_1^2} \quad (28)$$

$$CL_{24} = \frac{\left(\frac{l}{2}\right)^2 mk_a - \frac{l}{2}k_1k_a}{-k_2m + k_1^2} \quad (29)$$

$$CL_{25} = \frac{-\frac{l}{2}mc_a + k_1(c_a + c_b)}{-k_2m + k_1^2} \quad (30)$$

$$CL_{26} = \frac{-\frac{l}{2}mk_a + k_1(k_a + lk_b)}{-k_2m + k_1^2} \quad (31)$$

$$CL_{27} = \frac{k_1m_m}{-k_2m + k_1^2} \quad (32)$$

$$CL_{28} = \frac{k_1c_b}{-k_2m + k_1^2} \quad (33)$$

$$CL_{29} = \frac{k_1lk_b}{-k_2m + k_1^2} \quad (34)$$

Nonlinear system response to a step reference and for a step disturb was used to determine the performance criteria.

Figure 3 shows the nonlinear system in closed loop, without controllers, step response. This response is characterized by the influence of two vibrations modes: one slower and overdamped and the other faster and oscillating. It practically has no overshoot. The settling time, considering an accommodation range of $\pm 5\%$ of the reference signal amplitude, is more than 12.5s. The rise time from 0 to 100% of the reference signal amplitude is greater than 19s. This large difference between the rise time and the settling time highlights the influence of the overdamped mode [3].

Figure 4 shows the non-controlled system response to a disturbance.

With the reference fixed at zero, when a 0.01m amplitude step disturbance is injected into the system without the controller, its output goes upper than one and a half the amplitude

of the injected disturbance. The non-controlled system needs about 12.8s to reject this disturbance on the mentioned condition, considering that the disturbance is sufficiently rejected when the response amplitude is reduced to a range of $\pm 5\%$ of the injected disturbance amplitude, around zero. Figure 4 shows this response.

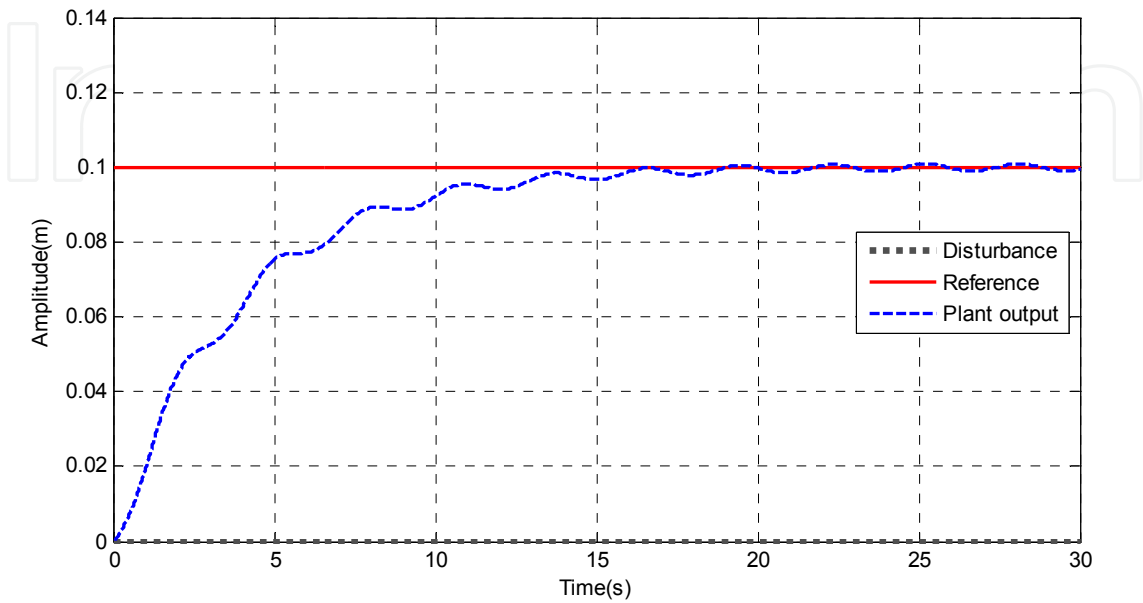

Figure 3. Electromechanical system step response without controllers and disturbance

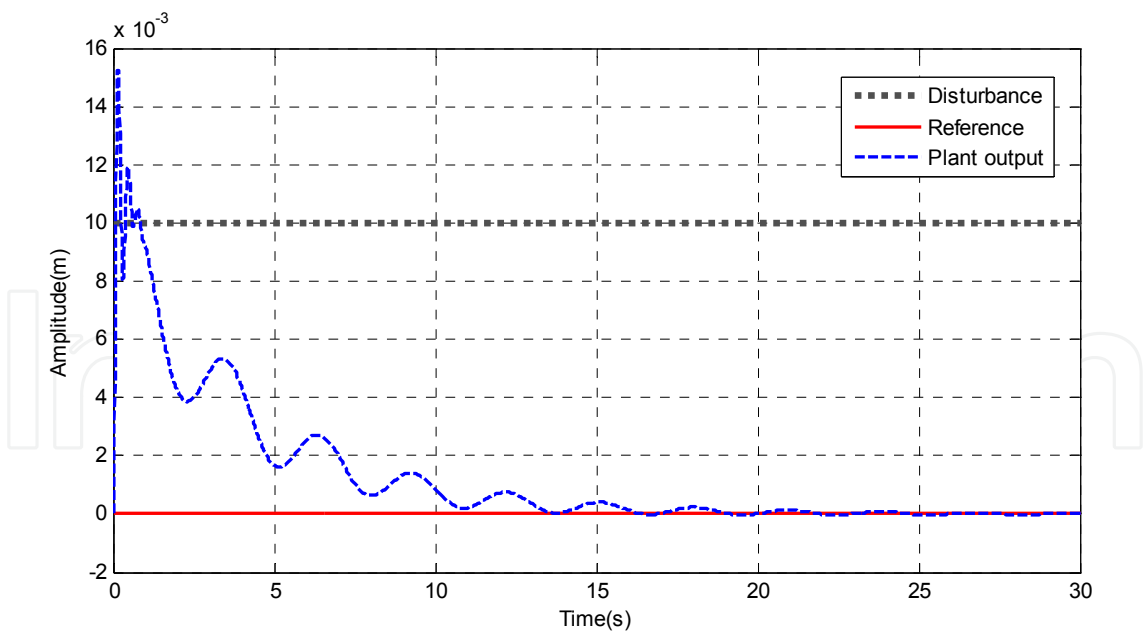

Figure 4. Non-controlled system response to a step disturbance

Thus, the performance specifications that characterize a satisfactory response to the nonlinear system are: A step reference signal must be tracked without regime error; the rise time should be reduced to at most 10% of the time obtained by the non-controlled system;

The settling time should be reduced to at most 20% of the time obtained with the non-controlled system; The overshoot should be less than 10%; The time required for the controlled system to reject a step disturbance, must be reduced by at least 95%; Furthermore, the response signal may not exceed 40% of disturbance's amplitude; Finally, the control signal generated must respect the servo-actuator saturation limits, that, in this case, is $\pm 15V$.

Those specifications were achieved through the use of the hierarchical fuzzy controller. Each controller design aimed to meet some performance specifications. In that way, conflicting specifications were separately addressed, instead of trying, in each project, to get a fit to satisfy conflicting specifications, relaxing those specifications. So the hierarchical fuzzy controller should take the best features of each controller, to meet all the specifications described in this section.

3. Robust control

In vibration control, as well as in several other applications, it is desired that the control system presents robustness to the effects of factors such as: modeling errors, variations in the parameters of the system being controlled, noise and disturbances. There are at least two reasons why the robustness is a desirable feature in the control systems: the need of control systems that operates satisfactorily, even in operating conditions different from the ones considered in the model design; and the possibility to adopt an intentionally simplified project model, to reduce: the time spent in the modeling stage and the resulting controller complexity [4].

Among the main techniques for robust controllers synthesis can be cited: The Linear Quadratic Gaussian / Loop Transfer Recovery (LQG/LTR), H_2 and H_∞ optimizations, methods based on Lyapunov functions, minmax optimization and Quantitative Feedback Theory (QFT).

The LQG/LTR controller designed in [1] was used to allow a better comparison between the optimized hierarchical fuzzy controller implemented and the non-optimized developed in [1]. Furthermore the LQG/LTR technique has a simple and systematic design procedure, the controller robustness is ensured by this procedure, even in a broad class modeling errors presence and also the number of design parameters is relatively small [5].

This procedure has two steps: initially the target filter loop (TFL) must be projected. It must meet the performance specifications previously established. Once obtained an appropriate TFL, its characteristics are recovered for the transfer function of the loop formed by the controller and the nominal model $(G_K(s) \cdot G_N(s))$.

The LTR procedure, initially proposed in [6], suggests that the TFL is achieved through the design of a Linear Quadratic Regulator (LQR) and then recovered by adjusting a Kalman filter. Another way to do it is to set a Kalman filter, to obtain a satisfactory target filter loop, and then project an optimal state feedback, type LQR, to recover the TFL [1].

Given the linearized model in form:

$$\begin{aligned}\dot{\mathbf{x}}(t) &= \mathbf{A}\mathbf{x}(t) + \mathbf{B}\mathbf{u}(t) \\ \mathbf{Y}(t) &= \mathbf{C}\mathbf{x}(t)\end{aligned}\quad (35)$$

The Kalman's filter design begins with the solution of the following algebraic Riccati equation:

$$\mathbf{A}\boldsymbol{\Sigma} + \boldsymbol{\Sigma}\mathbf{A}^T + \mathbf{W}\boldsymbol{\Sigma}\mathbf{W}^T - \boldsymbol{\Sigma}\mathbf{C}^T\boldsymbol{\Theta}^{-1}\mathbf{C}\boldsymbol{\Sigma} = 0 \quad (36)$$

In [1] it was used:

$$\mathbf{W} = \mathbf{B}(:,1); \boldsymbol{\Sigma} = \mathbf{I}; \boldsymbol{\Theta} = \mu\mathbf{I} \quad (37)$$

Where $\mathbf{B}(:,1)$ corresponds to the first column of the B matrix and μ is the project's free parameter. This choice was made because the first attempt to select the W matrix must be the matrix related with the control input [5]. As could be seen in [1], this choice proved satisfactory.

In [1] were also used: $\mu = 10^{-6}$ to obtain the TFL and $\rho = 10^{-12}$ to recover the TFL, resulting in a LQG/LTR robust controller with the following desired characteristics: good speed in test model controlled response accommodation, when tracking a reference, and principally a good rejection of disturbances. Figure 5 illustrates the TFL obtained and recovered for these values of μ and ρ .

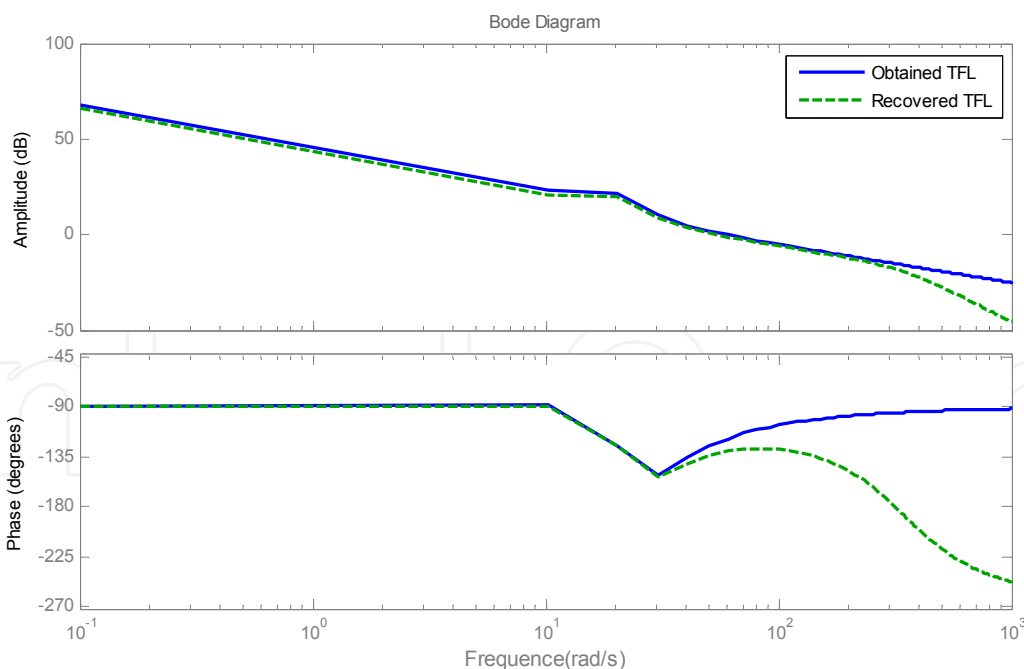

Figure 5. TFL obtained and recovered

As mentioned earlier, this LQG/LTR controller was used to allow a better comparison between the optimized hierarchical fuzzy controller implemented and the non-optimized developed in [1].

With the system controlled only by this robust controller, a step reference with 0.1m amplitude, was tracked without regime error; the rise time from 0 to 100% of the reference, in disturbance absence, was about 0.03s which corresponds to 0.16% of the rise time obtained by the non-controlled system; the settling time for ($\pm 5\%$) was 0.17s, so, it was reduced to 1.36% of the time obtained with the non-controlled system; the overshoot was 22.4% and the control signal generated to track this reference signal, surpassed the actuator saturation levels. Therefore, with respect to the reference tracking, the controller could not satisfy two performance criteria established, because the overshoot was higher than 10% of the reference signal and some control signals produced, extrapolates the servo actuator saturation levels. Figures 6 and 7 show the system response when controlled only by this LQG/LTR robust controller.

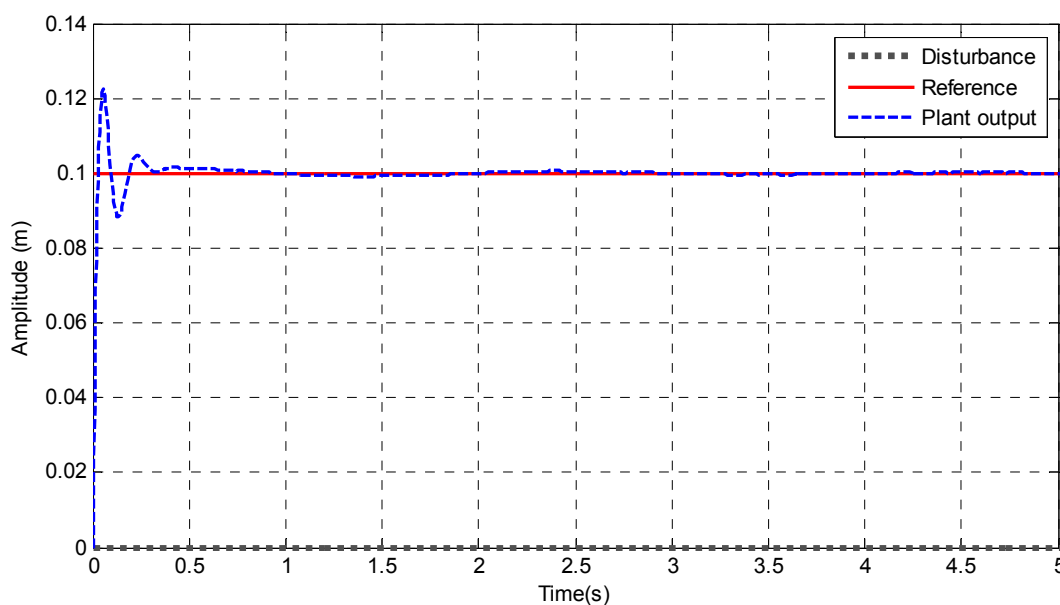

Figure 6. System response on step reference tracking, only with the robust controller, and in disturbances absence

With a null reference, a 0,01m step disturbance was injected in the system. The time required for the system to reject this disturbance using only the robust controller, was approximately 0.17s; what represents a 98.67% time reduction when compared to non-controlled system exposed to the same situation; The response signal maximum amplitude was 17.89% of the disturbance amplitude; the control signal varied within the levels of the servo actuator saturation. So in disturbance rejection, with null reference, the robust controller met all performance requirements described, as could be seen on figures 8 and 9.

It was also evaluated the system response, only with the robust controller, to a square wave reference with 0.1m peak to peak, 0.015Hz frequency and 100s duration. The system tracked this reference without regime error, the rise time and the settling time satisfied the performance specifications, but, again, as was expected, the control signal exceeded the actuator saturation limits and the overshoot exceeded the maximum stated in performance criteria, as could be seen on figures 10 and 11.

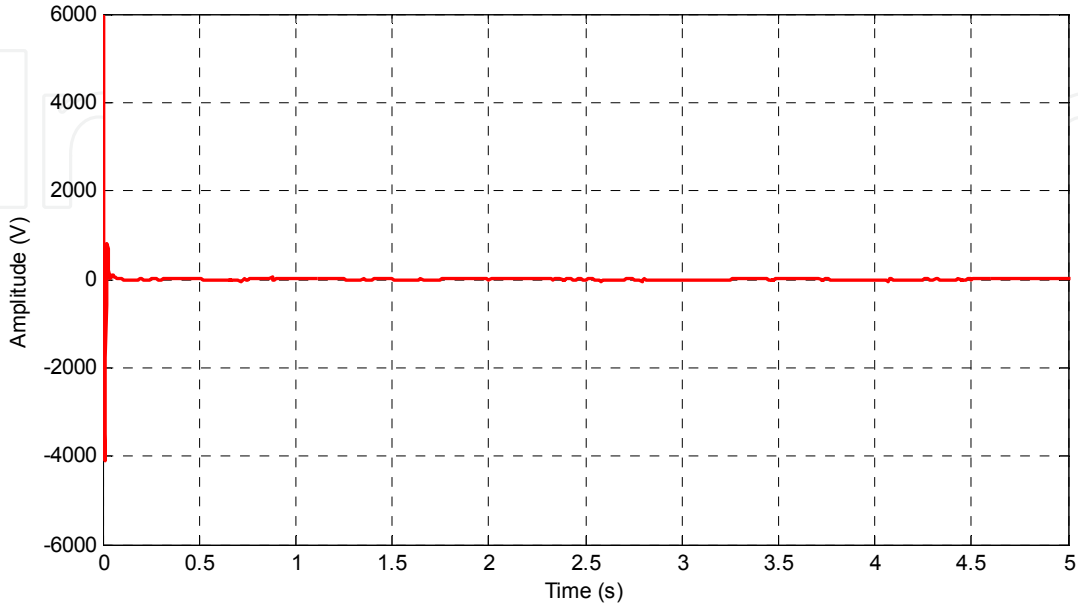

Figure 7. Robust controller signal for a step reference tracking, in disturbances absence

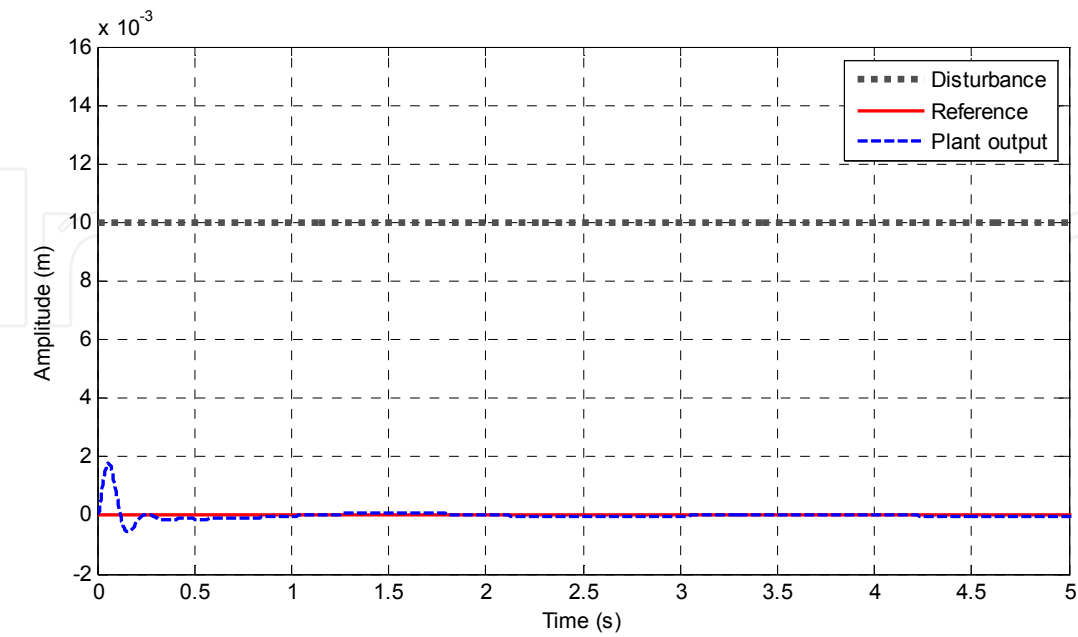

Figure 8. System response on step disturbance rejection, only with the robust controller, and with a null reference

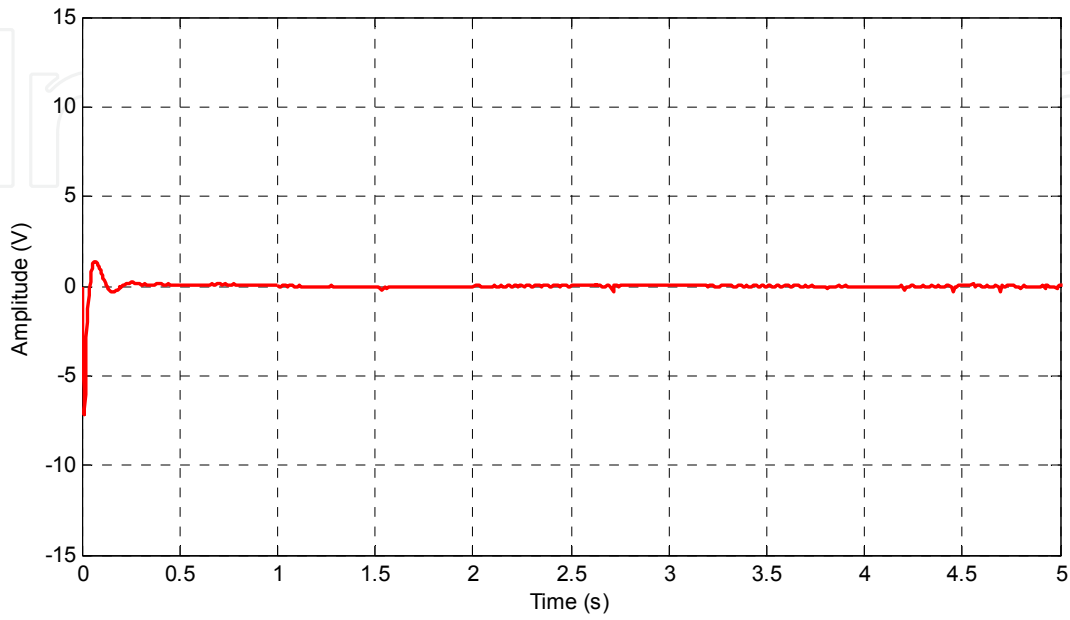

Figure 9. Robust controller signal for a step disturbance rejection, with a null reference

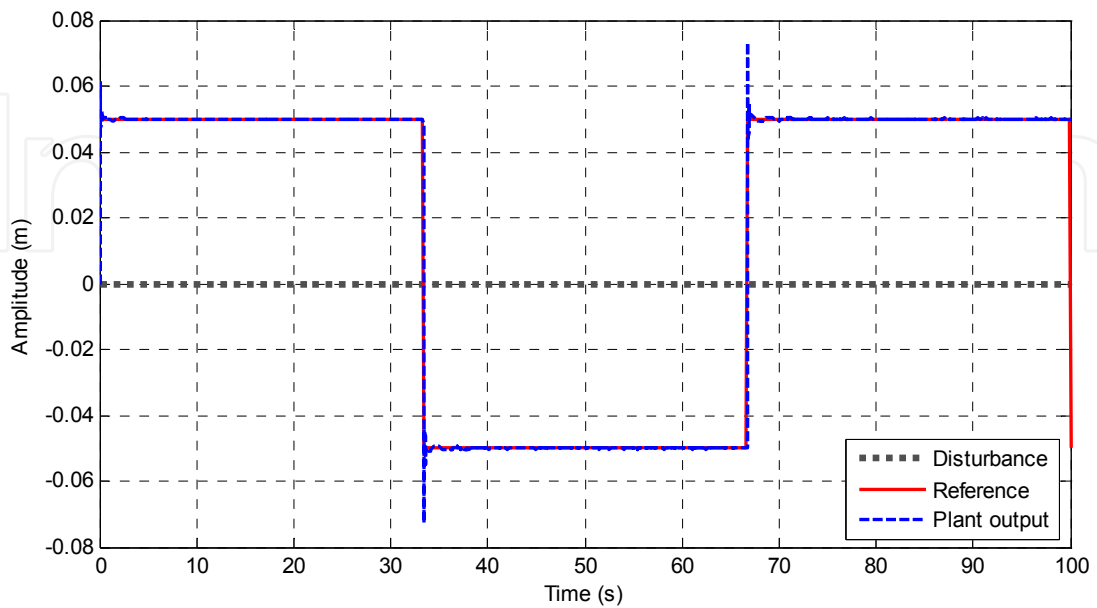

Figure 10. System response on square wave reference tracking, only with the robust controller

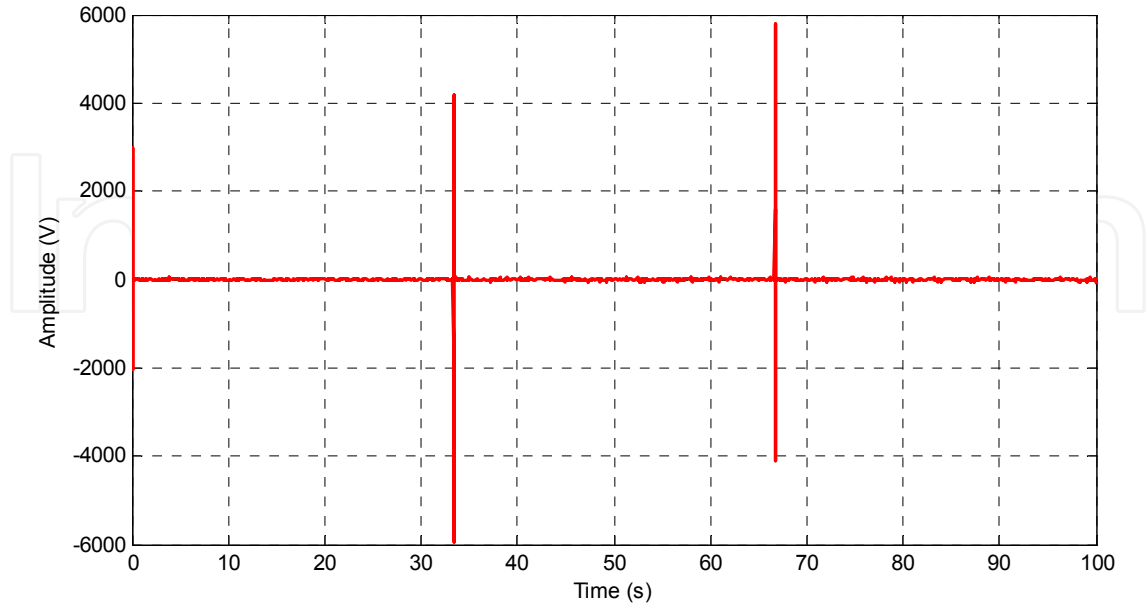

Figure 11. Robust controller signal for a square wave reference tracking, in disturbances absence

Finally, the system, only with the robust controller, was tested on tracking a step reference in the presence of uniformly distributed white noise with 0.02m peak to peak. Figures 12 and 13 show the system response and the control signal applied to the plant in this situation.

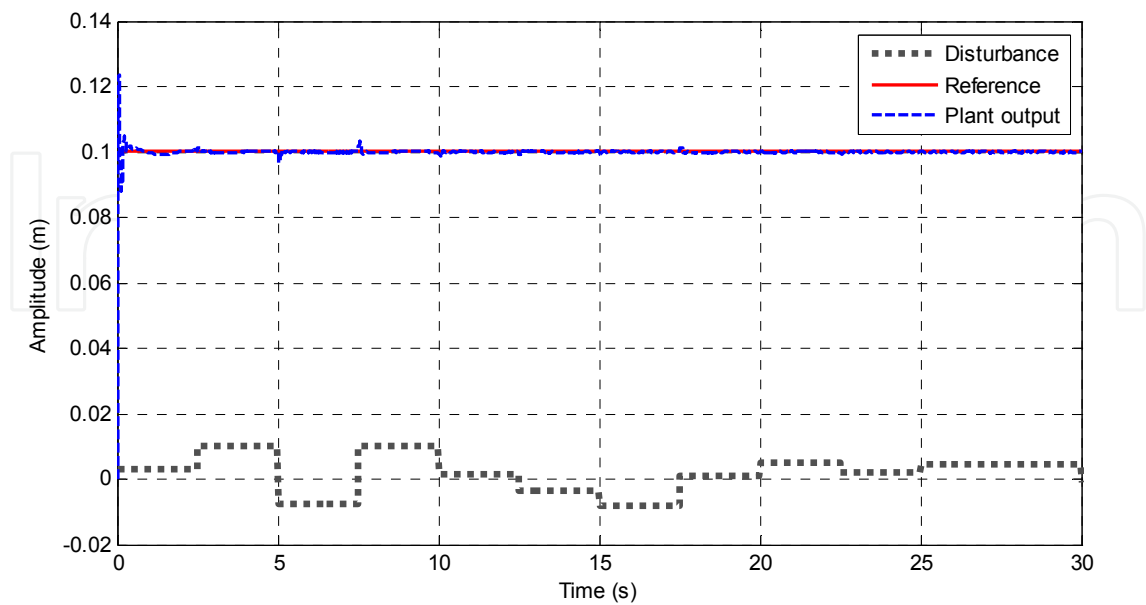

Figure 12. System response on step reference tracking, using only the robust controller, and in uniformly distributed white noise presence

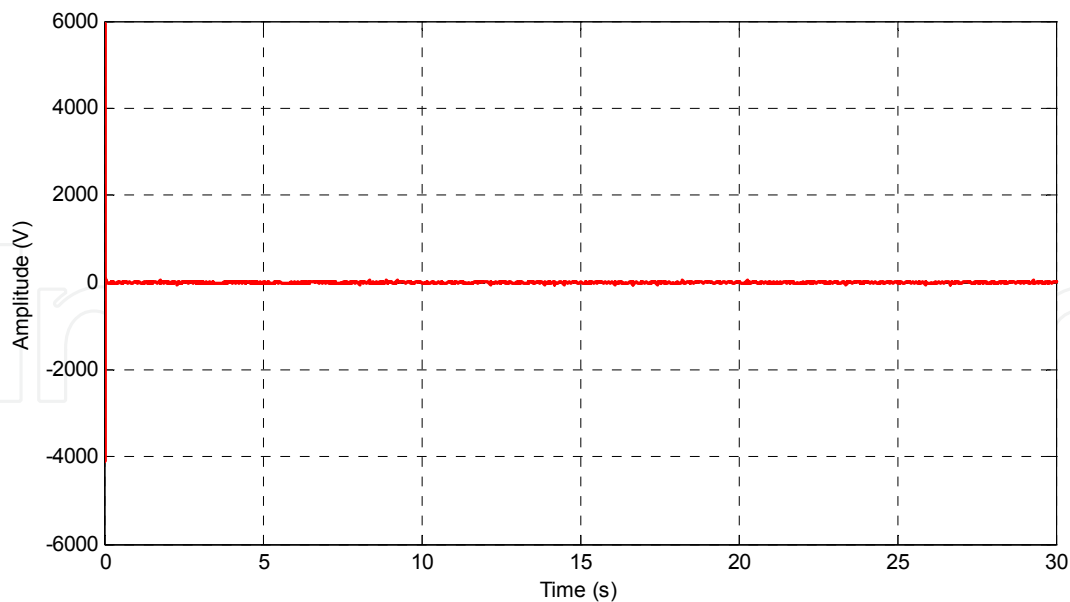

Figure 13. Robust controller signal for a step reference tracking, in uniformly distributed white noise presence

Comparing those results with the first shown, it is concluded that the rise time and the settling time were the same for both situations. In the white noise presence, the system showed a slightly higher overshoot, 23.4%, what is unsatisfactory according to the performance criteria, as well as the control signal applied that extrapolates the actuator saturation limits. So, as expected, in both cases the same performance requirements were not satisfied.

Therefore, those requirements should be met by the fuzzy controller and the supervisor must properly combine those two controllers to meet all performance criteria.

4. Fuzzy control

Fuzzy controllers are those that make use of fuzzy logic, which is based on the fuzzy sets' theory. This theory was developed by Zadeh in 1965 [7], to deal with the vague aspect of information through the mathematical representation of expressions commonly used by humans, also called linguistic variables, which give a not exact value to a variable characteristic of the object under observation.

Fuzzy logic attaches to a statement, not the value 'true' or 'false', but a veracity degree within a numeric range.

Due to its ability to handle uncertainty and imprecision, fuzzy logic has been characterized as one of the current technologies for the successful development of systems to control sophisticated processes, enabling the use of simple controllers to satisfy complex design requirements, even when the model of the system to be controlled has uncertainties [8-14].

The greatest difficulty in creating fuzzy systems is the definition of linguistic terms and rules. One way to solve this problem is to use hybrid approaches as models called neuro-fuzzy. In a neuro-fuzzy system those parameters are learned with the presentation of

training pairs (input, desired output) to a neural network whose nodes basically computes intersection and union operators [15-18]. Another hybrid approach that allows the parameters tuning for fuzzy systems, consists in the use of genetic algorithms [19].

A satisfactory definition of the number of membership functions and the degree of overlap between them is fundamental when implementing a fuzzy controller. It directly influences on the next stage, called inference [20].

The inference uses a set of rules that describe the dependence between the linguistic variables of input and output functions. This relationship is usually determined heuristically and consists of two steps: aggregation, when evaluating the 'if' part of each rule, through the operator "and fuzzy," and the composition stage, using the operator "or fuzzy" to considering the different conclusions of the active rules [20, 21].

After the inference from the action to be taken, the classical fuzzy models require a decoding of the linguistic value for the numeric variable output, called defuzzification. This output can represent functions such as adjusting the position of a button, or provide voltage to a particular motor.

The Takagi Sugeno fuzzy controllers do not need a defuzzification step, because they obtain this precise equivalence directly [9, 19]. Therefore they were used to compound the fuzzy hierarchical controller.

For the design and optimization of the fuzzy logic controller it was used the nonlinear model of the physical system, as this model provides a more accurate representation of it.

All available knowledge about the system being controlled is of fundamental importance for the initial stage of designing a fuzzy controller, therefore, knowing the geometrical characteristics, the dynamics and any system particularity, can significantly reduce the project effort [1]. The fuzzy logic controller used has the following structure: Two inputs, which are: the tracking error (the difference between the reference and the system output) and its derivative; an output which is the control signal. For the output variable composition 25 first-order Sugeno functions are used; five linguistic variables were defined for each input variable: Negative Big, Negative Small, Zero, Positive Small and Positive Big; Triangular membership functions were chosen for the input variables; The probabilistic t-norm and t-conorm operators were chosen; The rule base is composed by 25 rules. For each rule there is a Sugeno output function; For the inference procedure, the Sugeno interpolation model was chosen.

The tuning of this fuzzy controller was made by a genetic algorithm. This algorithm is based on the laws of natural selection and evolution. It searches to an optimal solution in the space of solutions given by the designer, using probabilistic rules for combining solutions in order to improve their quality. It is therefore an efficient search strategy that can be used in optimization or classification problems [22-25].

In the fuzzy controller's optimization, each individual is formed by 70 genes. The first 20 genes represent the input membership functions. The 50 subsequent genes describe the coefficients of the Sugeno output functions, t_i and s_i . Those functions are given by:

$$\left[t_i \cdot e + s_i \cdot \frac{de}{dt} + 0 \right] \quad (38)$$

Where: e is the error.

With the use of genetic algorithms for tuning of all parameters of fuzzy controller, the designer's task is to limit the search space of GA and find a good setting of its parameters, in order to obtain the desired results.

The determination of the limits of the search spaces for the fuzzy controller optimization was based on the results obtained in [1] and in several tests. The population size, the percentage of mutation and the stopping criteria were also determined from several tests.

To obtain the results that will be shown, a square wave was used as reference, allowing a good fit to the fuzzy controller for several references. The genetic algorithm configuration was: population of 30 individuals, all children were generated by recombination with mutation probability of 5% for each gene; the roulette method was used on selection step. The stopping criteria were: maximum number of iterations equal to 100, repeating the best individual for 25% of the generations' maximum number, maintaining the average fitness of the population for 10% of the generations' maximum number and mean square error of 10^{-5} .

For the evaluation of each individual the control of the nonlinear system using only the fuzzy controller, was simulated during 100s. The evaluation function used for this controller tuning, was:

$$f_{ev}(ind.) = 8t_{r1} + 8t_{r2} + 8t_{r3} + 0,9o_{s1} + 0,9|o_{s2}| + 0,9o_{s3} + 0,7t_{s1} + 0,7t_{s2} + 0,7t_{s3} + 15e_m^2 + u_{max} - u_{min} \quad (39)$$

Where: the " t_{ri} 's" are the rise times, the " o_{si} 's" are the overshoots, the " t_{si} 's" are the settling times, " e_m " is the average error, " u_{max} " is the maximum positive amplitude of the control signal above actuator's saturation and " u_{min} " is the maximum amplitude of the negative control signal, below actuator's saturation.

Higher weights were given to the mean square error and to the rise times because it was observed that they had a lower representation in the evaluation function, than the settling time and the peaks of the control signals above actuator's saturation. Thus allowing to the genetic algorithm, the search for a tune that provides not only short settling times through low control signals, but also small rise times, and that the system does not presents regime errors. Lower weights were given for the settling times and the overshoots, to allow the search for fuzzy controllers that give the system a higher speed.

Figures 14 and 15, shows the fuzzy controller optimized membership functions.

Two search spaces were defined for output functions' coefficients determination: one from 0 to 100, for the coefficients of the functions associated with rules that involve in its antecedent the linguistic variables negative big or positive big, and another from 0 to 60 to the

coefficients of the other functions. The independent terms of output functions were not optimized and were always made equal to zero. The output functions obtained after the tuning can be seen in Table 1.

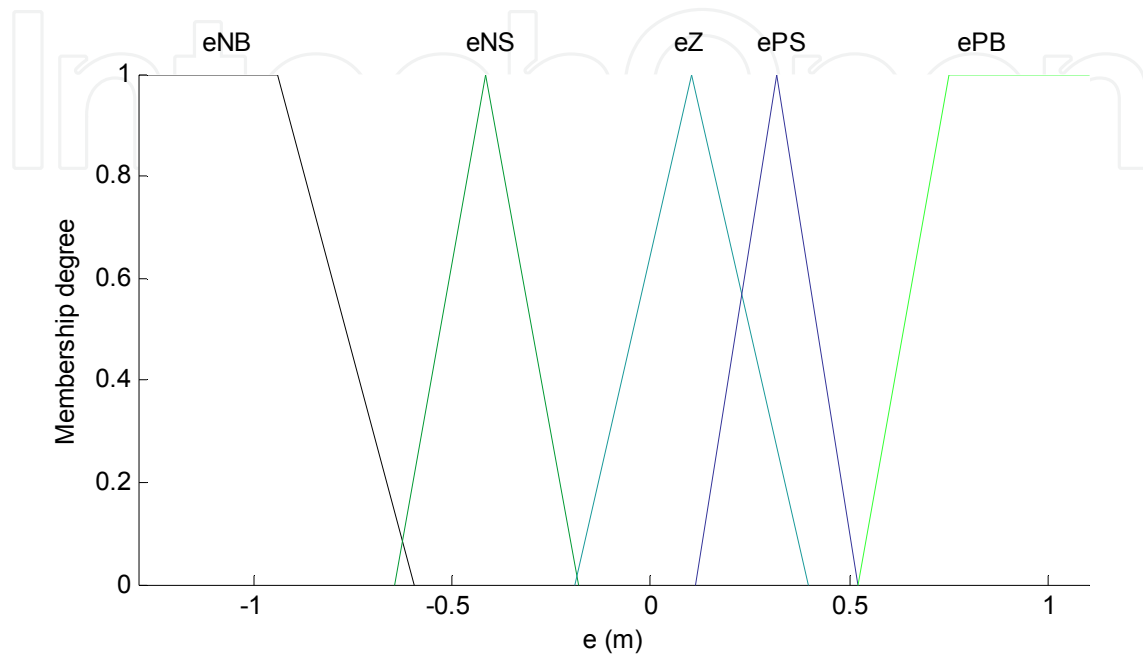

Figure 14. Fuzzy controller optimized membership functions of error input

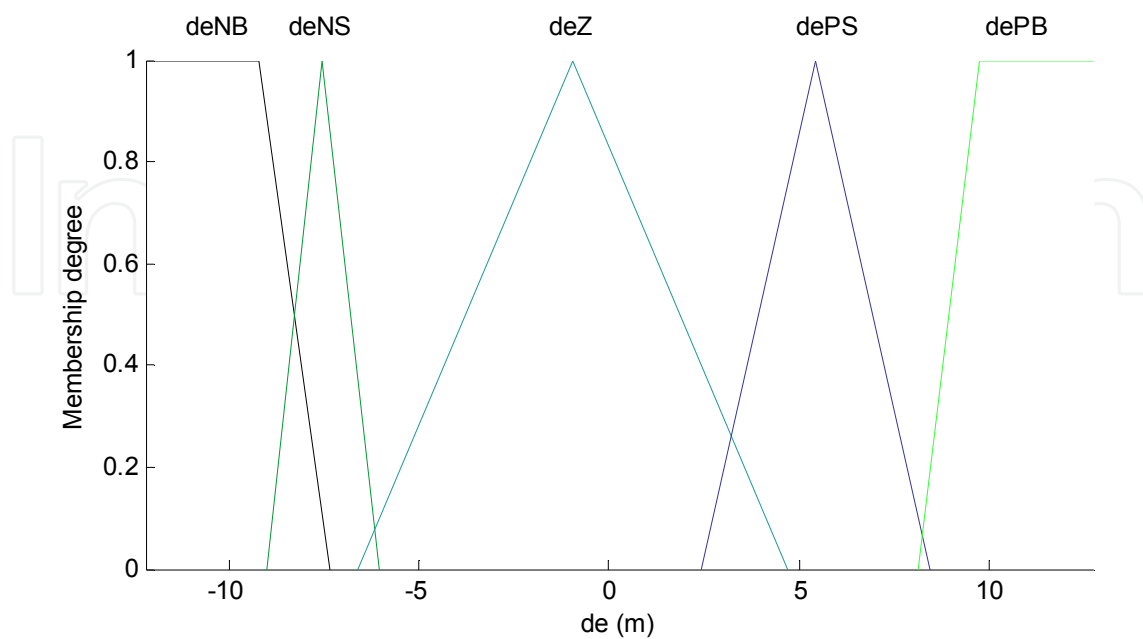

Figure 15. Fuzzy controller optimized membership functions of error derivative input

Function name	Parameters [t s]
S1	[10.93 94.07]
S2	[95.34 3.74]
S3	[25.50 27.17]
S4	[39.12 62.36]
S5	[95.86 94.12]
S6	[28.08 47.32]
S7	[46.76 43.30]
S8	[27.71 13.14]
S9	[42.55 5.52]
S10	[51.22 41.09]
S11	[53.64 5.98]
S12	[31.55 12.47]
S13	[53.31 1.20]
S14	[37.24 16.27]
S15	[33.20 46.69]
S16	[21.36 29.04]
S17	[2.97 23.94]
S18	[11.98 43.12]
S19	[42.94 45.81]
S20	[10.77 27.04]
S21	[75.33 50.81]
S22	[85.35 66.19]
S23	[45.64 50.41]
S24	[58.09 15.50]
S25	[15.18 11.76]

Table 1. Output functions' parameters of the optimized fuzzy controller

Table 2 shows the fuzzy controller rule base.

The control of the electromechanical system made only by the optimized fuzzy controller, presented a poor performance in tracking a 0.1m amplitude step reference, in disturbance absence. The overshoot presented was out of performance specifications (30.60%), and the settling time was almost equal to the uncontrolled system settling time (11.09s). However, the system showed no error at steady state, the rise time was satisfactory, 0.22 s, and the control signal produced was far below the actuator saturation, allowing the use of this controller in the hierarchical control scheme, as a supplier of control signals applicable in situations of great error, where the signals produced by the robust controller extrapolate the servo-actuator saturation. Those results are shown in figures 16 and 17.

		Error				
		eNB	eNS	eZ	ePS	ePB
Error derivative	deNB	S1	S6	S11	S16	S21
	deNS	S2	S7	S12	S17	S22
	deZ	S3	S8	S13	S18	S23
	dePS	S4	S9	S14	S19	S24
	dePB	S5	S10	S15	S20	S25

Table 2. Rule base of fuzzy controller

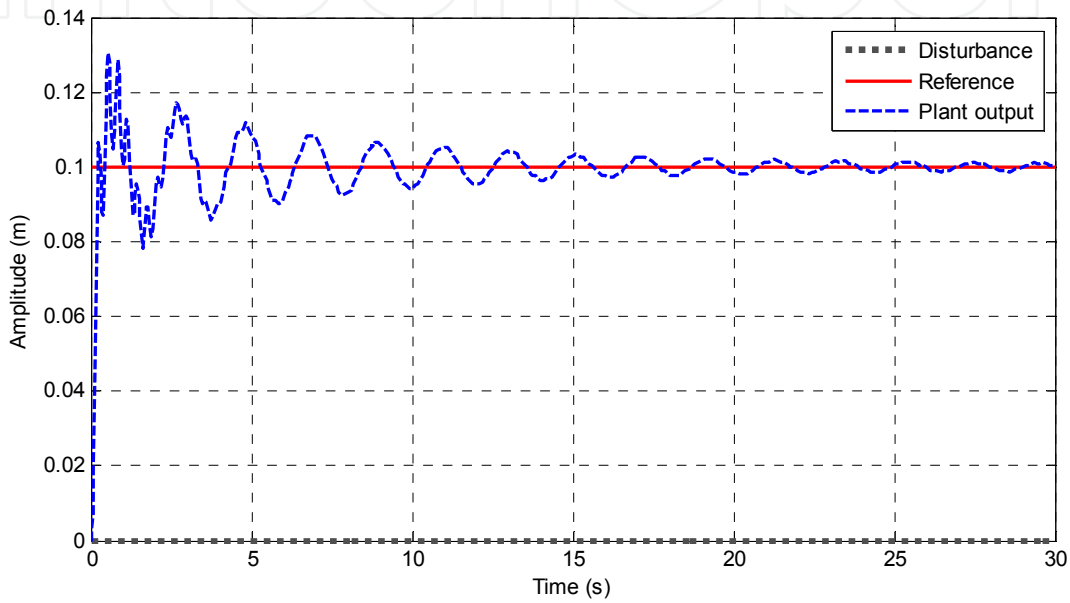

Figure 16. System response on step reference tracking, only with the fuzzy controller, and in disturbances absence

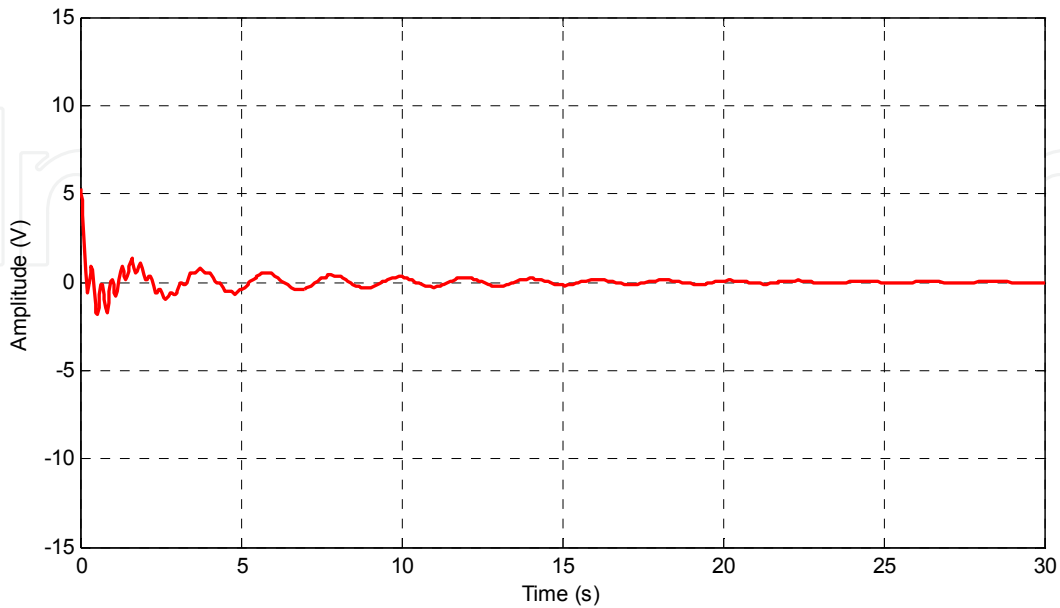

Figure 17. Fuzzy controller signal for a step reference tracking, in disturbances absence

In the rejection of a 0.01m amplitude step disturbance with the null reference, the system response with the fuzzy controller was also unsatisfactory, because its amplitude exceeded in 21% the disturbance amplitude, and it took about 2.01s to reject it, far above the 0.64s, established as a goal. Figures 18 and 19 show the system response and the control signal for this case.

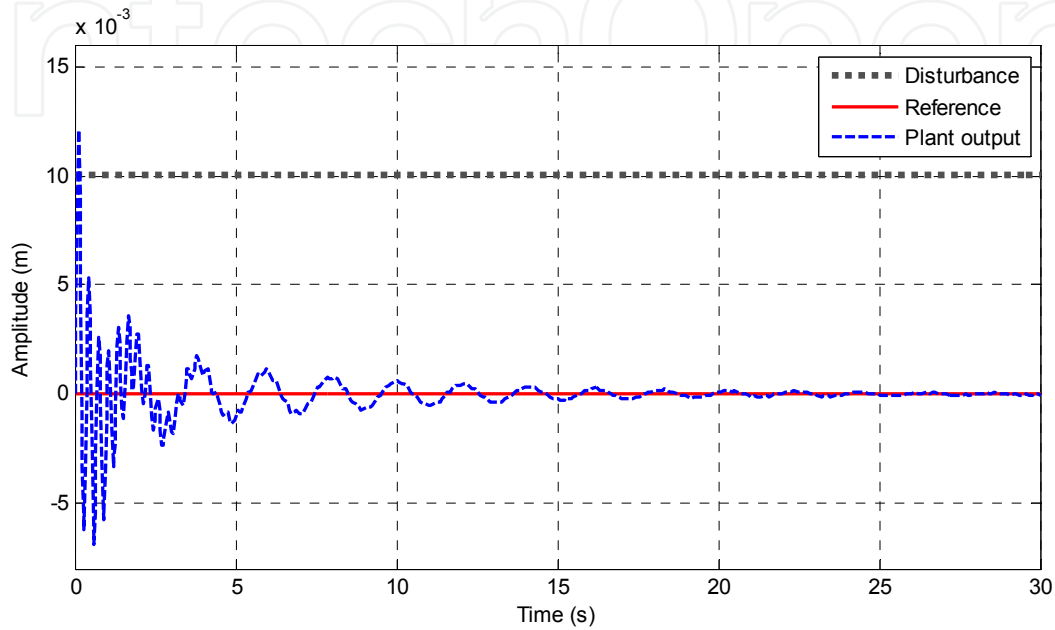

Figure 18. System response on step disturbance rejection, only with the fuzzy controller, and with a null reference

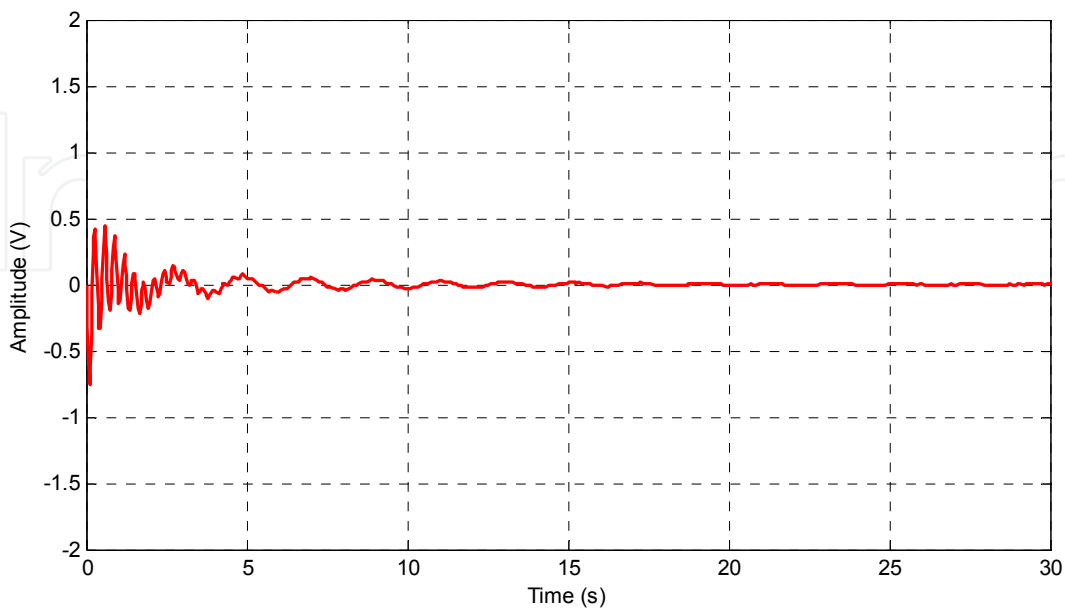

Figure 19. Fuzzy controller signal for a step disturbance rejection, with a null reference

It was also evaluated the system response on a square wave reference tracking in the absence of disturbances and using only the fuzzy controller. As can be seen in figures 20 and 21 the system tracked the reference without regime error, the rise times were acceptable, but the settling times were greater than desirable, moreover, the overshoot and the control signal extrapolated performance specifications. But the fuzzy controller's peak signal was much lower than the robust one.

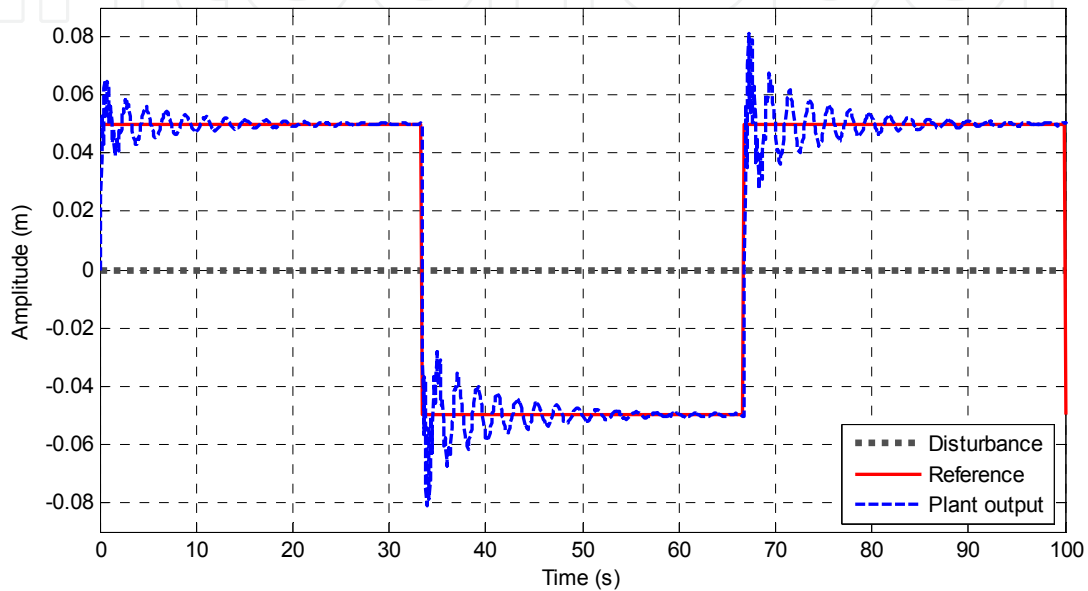

Figure 20. System response on square wave reference tracking, only with the fuzzy controller

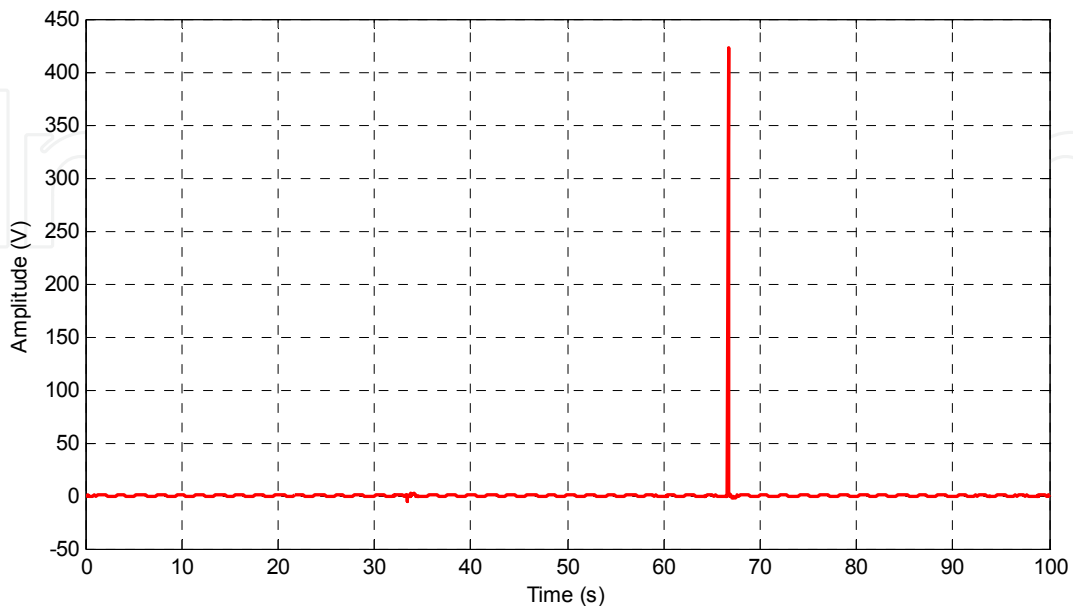

Figure 21. Fuzzy controller signal for a square wave reference tracking, in disturbances absence

From these results, it can be concluded that the function of the fuzzy controller is to bring the plant to a situation that favors the use of the robust controller, avoiding the extrapolation of control signal limits.

5. Fuzzy supervisor

The multiple controllers' fusion seeks to achieve higher performance than those obtained using only one controller.

The supervisor's task is to find an ideal combination of control signals generated by the controllers designed, in such way that this combination compose the control signal which will effectively act on the plant. To do this, the supervisor evaluates the operating condition in each instant, and then determines an importance hierarchy of each control signal. Therefore, in addition to control signals generated by the controllers, the supervisor must also receive information that enables to evaluate the operating condition at all instants, and then, based on this evaluation, the supervisor will sort, hierarchically, the outputs of the controllers, compounding then the control signal that will act on the plant. This hierarchy is the level of importance associated by the supervisor to each controller in every operating condition. It defines the participation of each controller in the control signal that will be applied on the plant.

The fuzzy supervisor used was a Takagi-Sugeno system with: two inputs, which are the same used in the fuzzy controller; 3 linguistic variables (negative, zero and positive), which are represented by trapezoidal membership functions; two output functions, which are zero order functions.

Figure 22 illustrates the architecture used for the control signals fusion via hierarchical fuzzy supervisor.

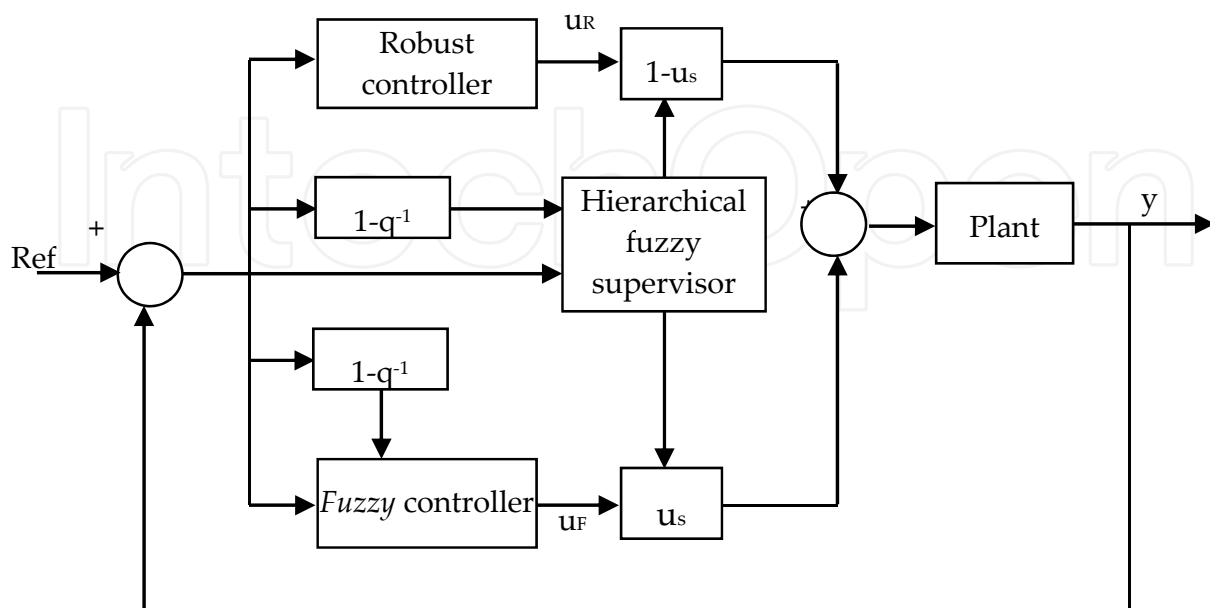

Figure 22. Control scheme using the fuzzy hierarchical controller

From the difference between a reference signal, specified by the operator, and the vertical position of the bar's free end, measured by a sensor, it is produced an error signal. With this error signal, the robust controller determines its control action, trying to correct the vertical position of the bar's free end. The fuzzy controller also provides a control signal in an attempt to eliminate the tracking error; for this, it needs this error signal and its derivative. The control signal which actually will act on the plant will be the weighted sum of signals produced by the controllers. The degree of participation of each control action is determined by the supervisor, which uses as well as the fuzzy controller, the error information and its derivative. According to the control signal, the servo-actuator will provide vertical displacements to bar's center, to correct the tracking error.

The two output functions used are the same presented in [1]. They are described in Table 3.

Function name	Parameters $[e(t) \ de(t)/d(t) \ 1] \times [t \ s \ 1]^T$
LTR	[0 0 0]
FUZ	[0 0 1]

Table 3. Output functions' parameters of the fuzzy supervisor

So, when supervisor output is null, only the robust controller will actuate on the plant, when supervisor output is equal to one, only the fuzzy controller will actuate, for intermediate outputs a combination of those controllers' signals will be applied on the plant.

The supervisor's input membership functions were tuned by a genetic algorithm using the square wave reference and the two controllers. Its evaluation function is given by:

$$f_{ev}(ind.) = t_{r1} + t_{r2} + t_{r3} + o_{s1} + |o_{s2}| + o_{s3} + t_{s1} + t_{s2} + t_{s3} + e_m^2 + 0,01u_{\max1} - 0,01u_{\min1} + 0,01u_{\max2} - 0,01u_{\min2} + 0,01u_{\max3} - 0,01u_{\min3} \quad (40)$$

There was no need to give greater weight to the mean square error and to the rise times, as was done for the tuning of the fuzzy controller, because from some tunings, the settling time and the overshoot became very small. The reduction of all performance descriptors along the supervisor tuning was so high that it was necessary to assign lower weights to control signals peaks above the saturation of the servo actuator, to avoid favoring a performance criterion and neglect others.

Figures 23 and 24, shows the fuzzy supervisor optimized membership functions.

The rule base of the supervisor was not optimized by genetic algorithm. It was the same used in [1], as shown in Table 4.

As mentioned the results obtained with the optimized hierarchical fuzzy controller will be compared with the ones obtained by the non-optimized one (presented in [1]). On tracking a 0.1m amplitude step reference, the optimized hierarchical fuzzy controller has satisfied all performance criteria established and presented a more rapid response than the system controlled by the non-optimized hierarchical fuzzy controller. The rise time from 0 to 100% of the reference was approximately 0.22s, which is half the one obtained in [1]. The

overshoot was 3.9% in [1] it was 7%. The settling time for ($\pm 5\%$) was 0.22s, less than half that was obtained in [1]. The control signal generated by the optimized hierarchical fuzzy controller to track this reference had lower levels than the ones generated by the non-optimized hierarchical fuzzy controller. The optimized hierarchical fuzzy controller has used the fuzzy controller for less time, it is because the optimized fuzzy controller provide a faster response than the designed in [1]. Also the transition between controllers was softer with the optimized system. Figures 25, 26 and 27 shows the results obtained with those two structures on the reference tracking in disturbances absence.

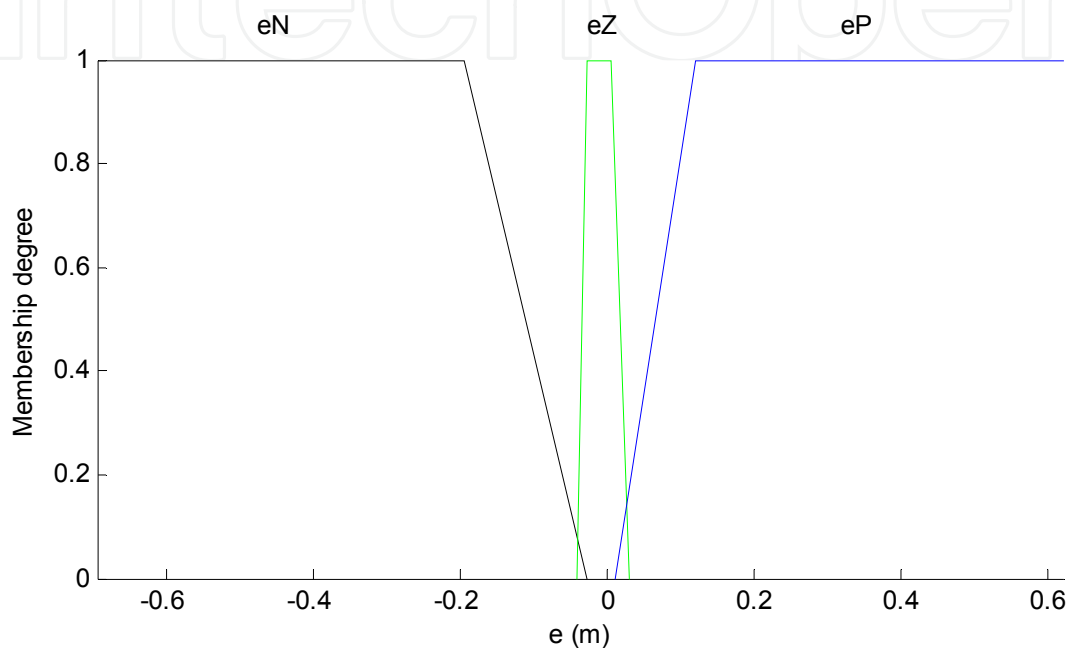

Figure 23. Fuzzy supervisor optimized membership functions of error input

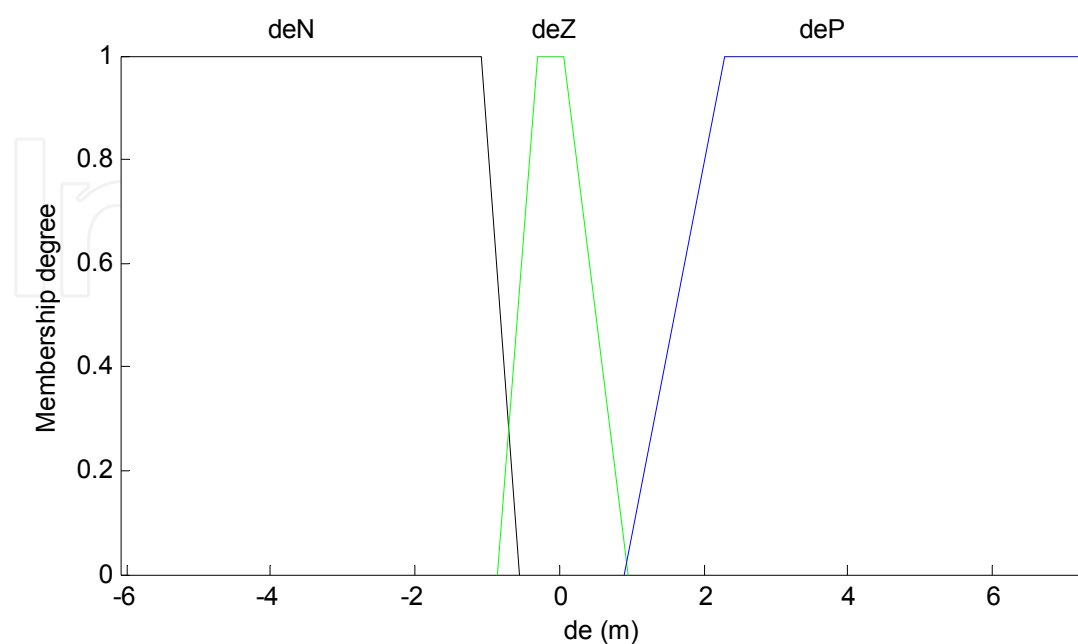

Figure 24. Fuzzy Supervisor optimized membership functions of error derivative input

		e (t)		
		eN	eZ	eP
de(t)/dt	deN	FUZ	FUZ	FUZ
	deZ	FUZ	LTR	FUZ
	deP	FUZ	FUZ	FUZ

Table 4. Rule base of supervisor

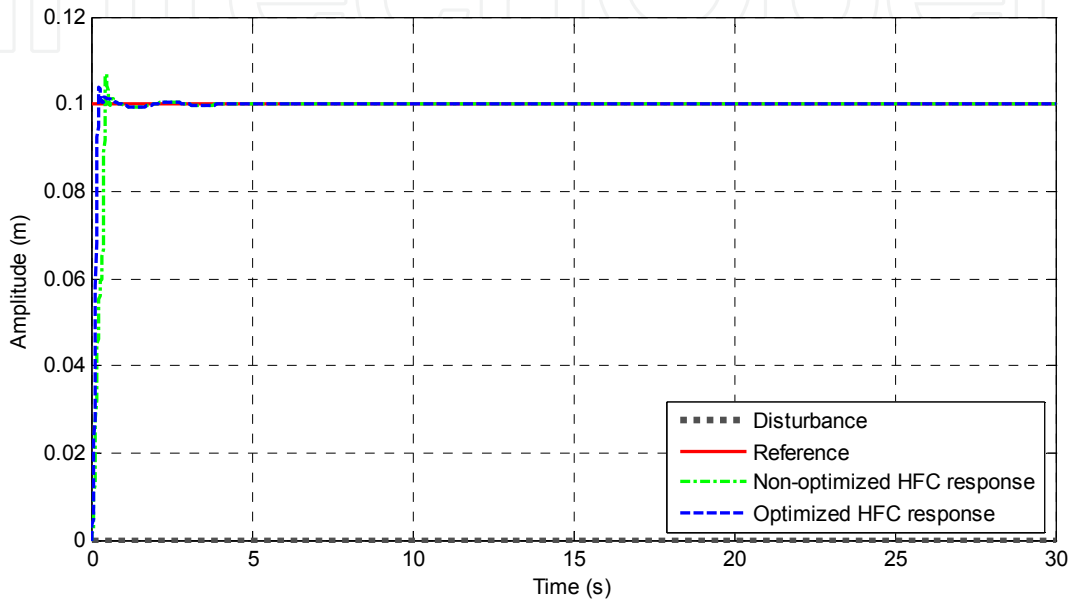

Figure 25. Comparison of the two hierarchical controllers in tracking a step reference

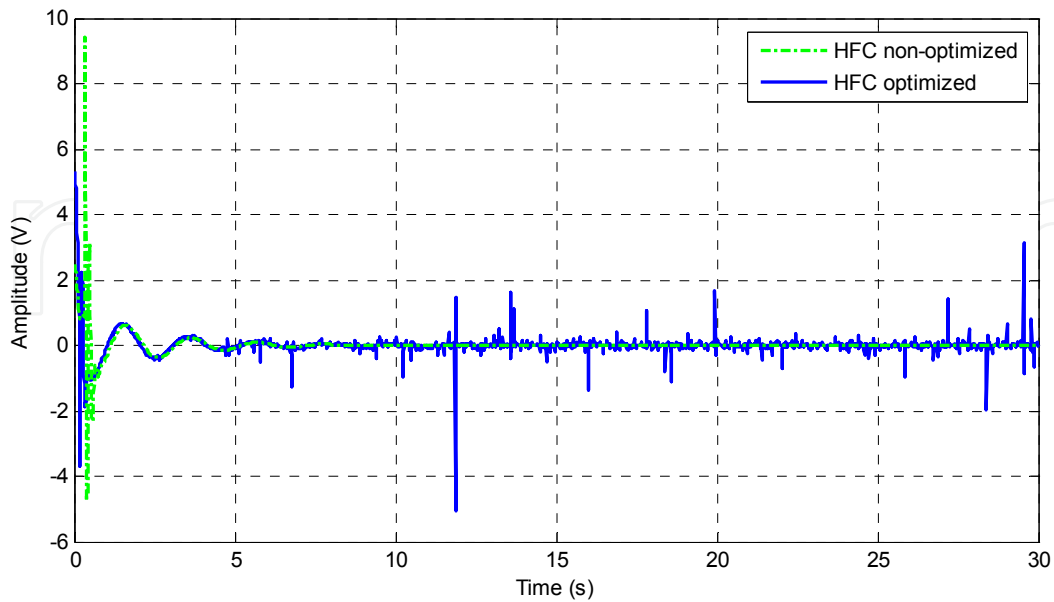

Figure 26. Comparison of control signals generated by the two hierarchical controllers in tracking a step reference

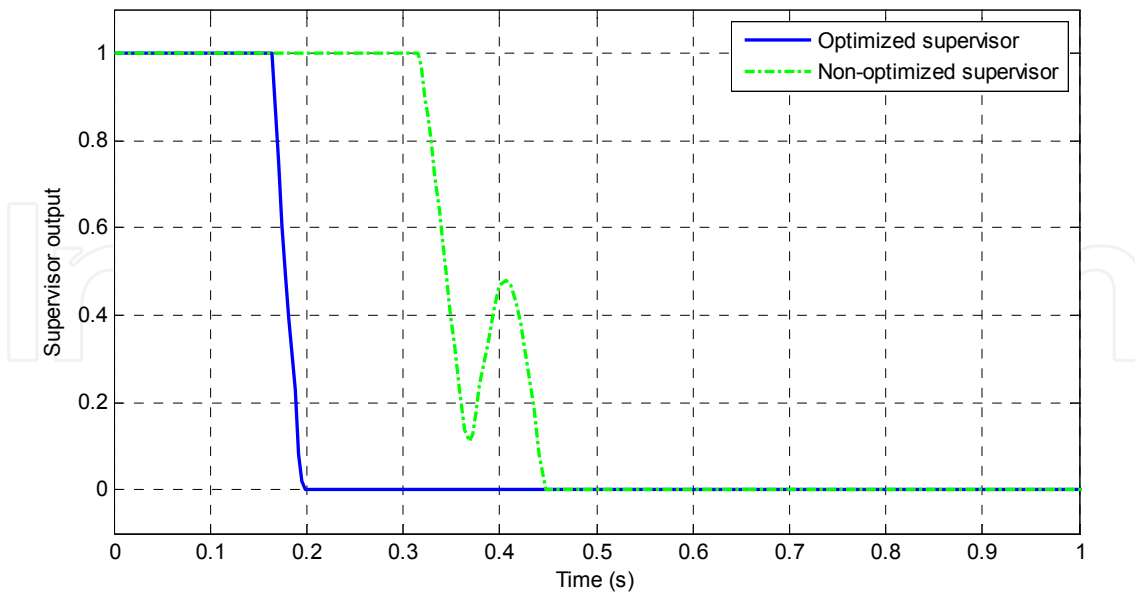

Figure 27. Comparison of signals generated by the two supervisors in tracking a step reference

The performance of the optimized HFC was tested on a step reference tracking, in the presence of white noise with 0.02m peak to peak. Figures 28 and 29 show, again, the best performance of the system controlled by the optimized HFC.

To finalize the comparisons, the system was tested on tracking a square wave reference. As expected, a better performance was obtained using the optimized HFC.

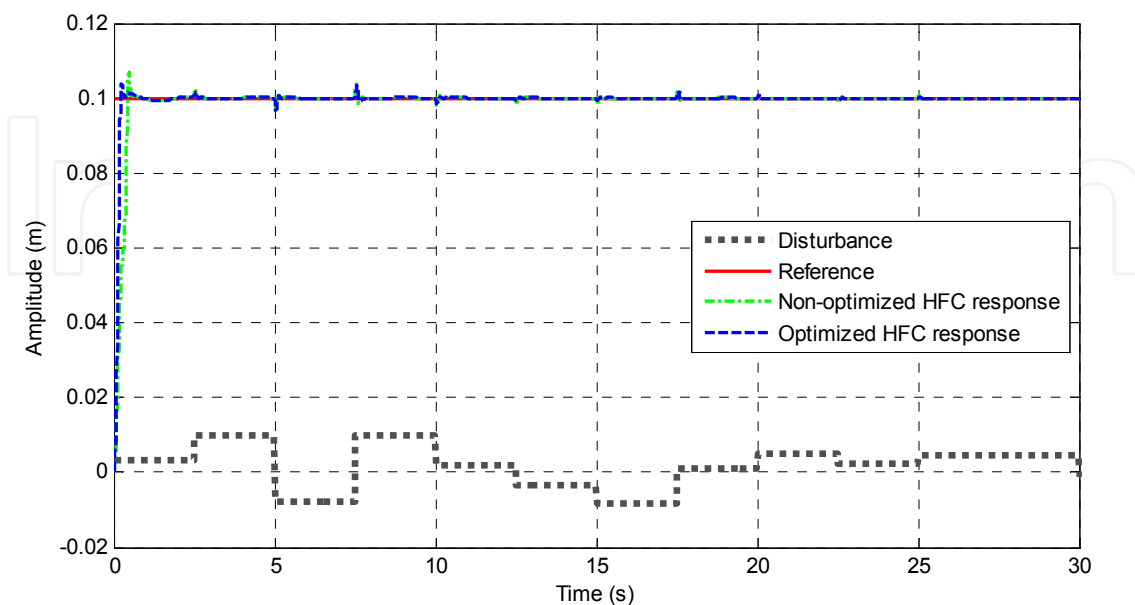

Figure 28. Comparison of the two HFC in tracking a step reference under disturbance

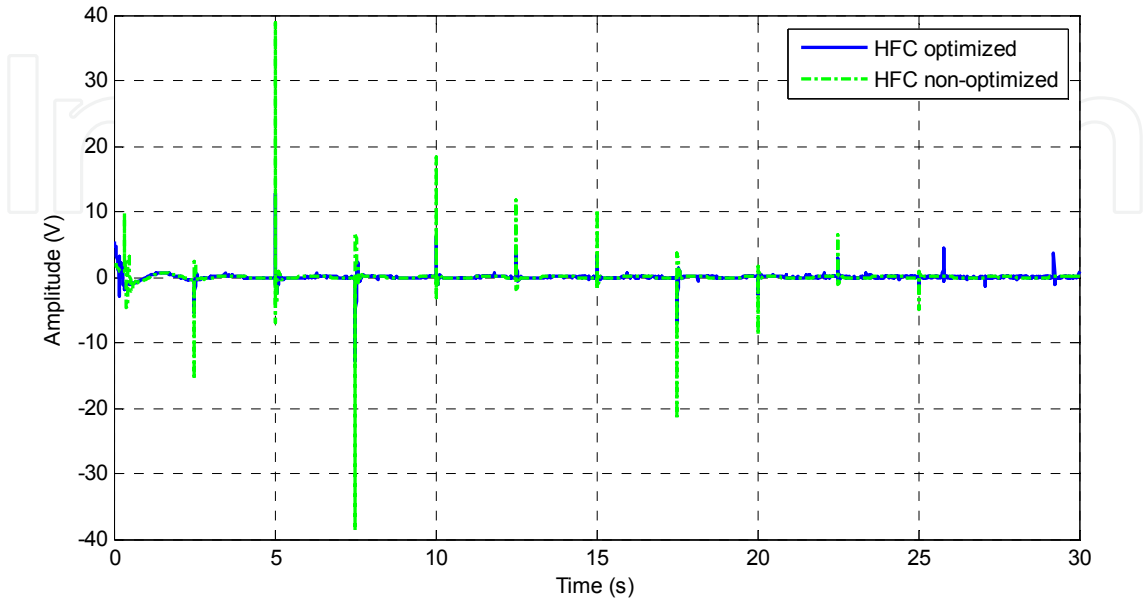

Figure 29. Comparison of control signals generated by the two HFC in tracking a step reference under disturbance

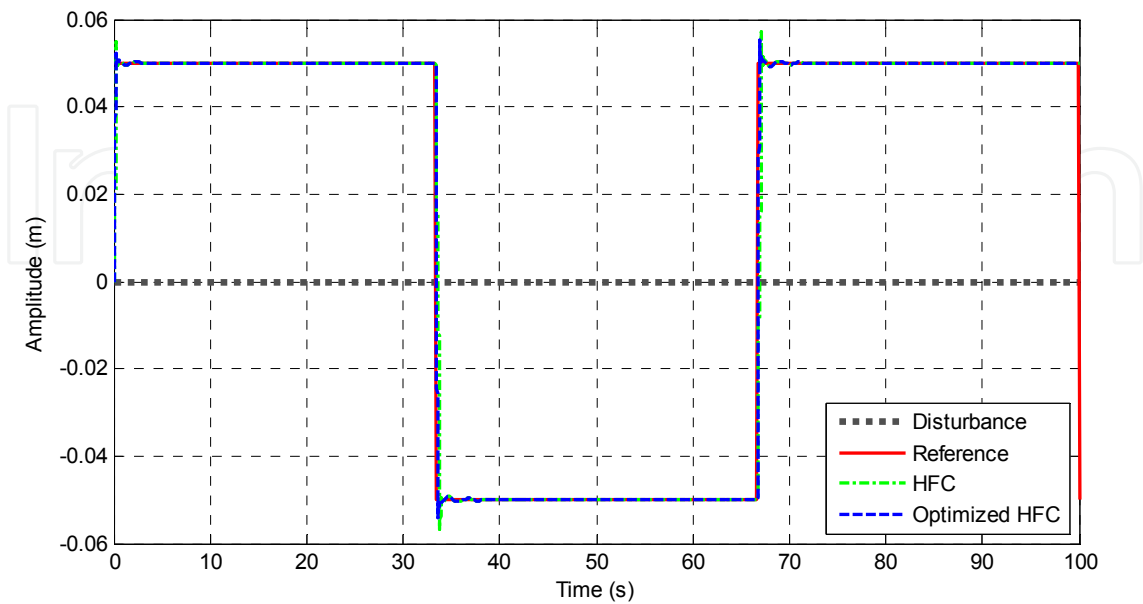

Figure 30. Comparison of the two HFC in tracking a square wave reference

As could be seen on Figure 31, both hierarchical controllers extrapolated the actuator saturation limits, as it was punctual the use of a saturator may not affect the system performance.

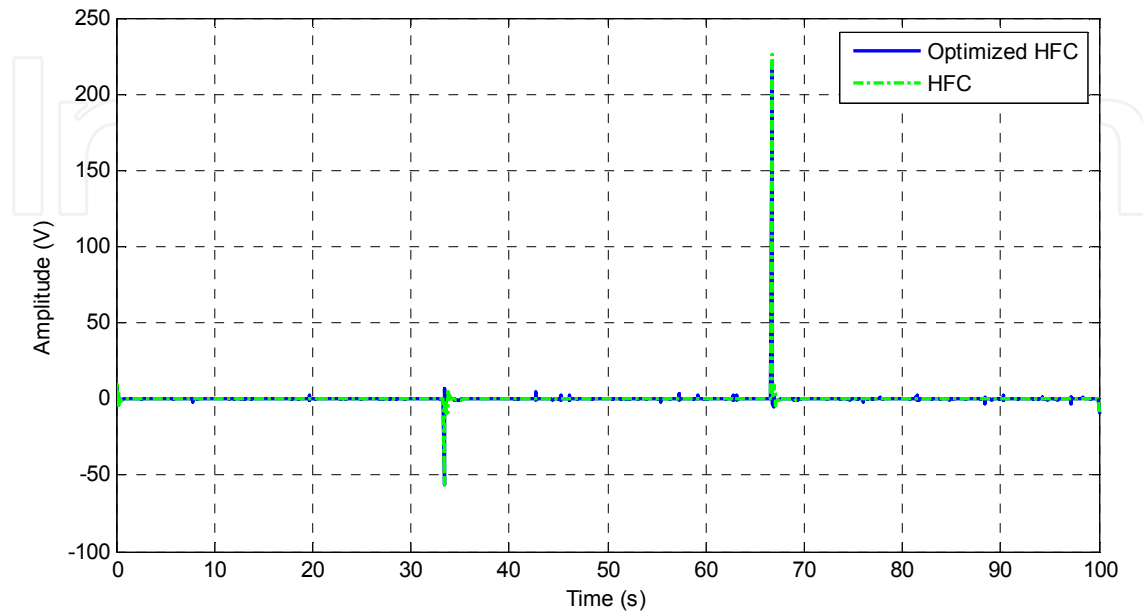

Figure 31. Comparison of control signals generated by the two HFC in tracking a square wave reference

Again the optimized supervisor has used less the fuzzy controller than the non-optimized supervisor.

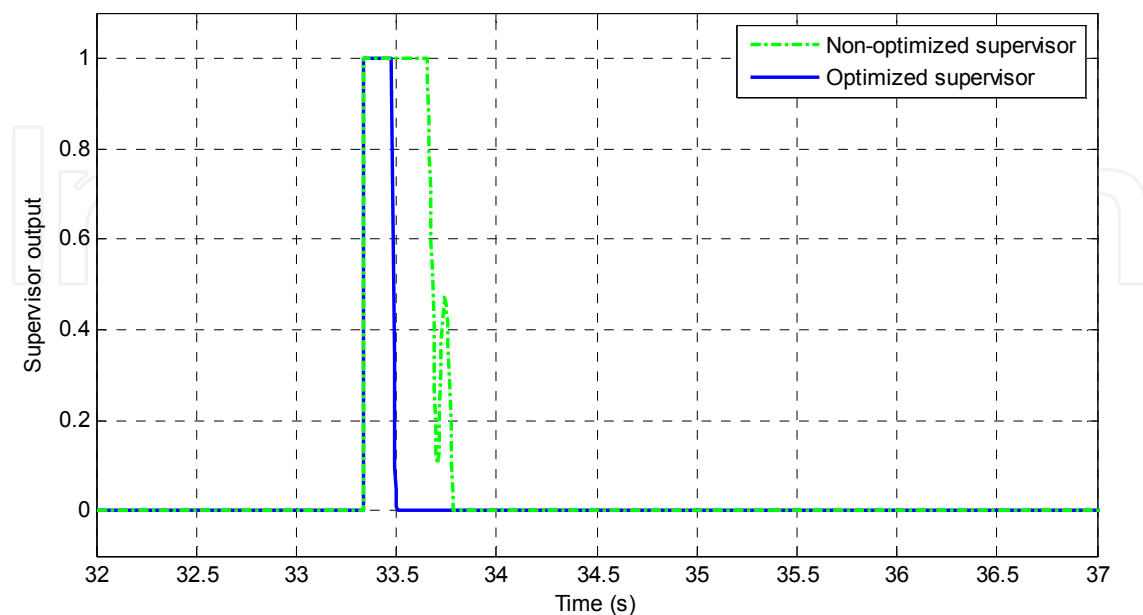

Figure 32. Comparison of signals generated by the two supervisors in tracking a square wave reference

6. Conclusion

One of the main advantages of hierarchical control is to combine different techniques. It allows the supervisor to take the best of each technique.

The results showed the advantages of using genetic algorithms, such as: making automatic tuning of fuzzy components of the HFC, greatly simplifying the design and allowing the obtaining of optimal controllers and supervisors, which is impossible via manual tuning.

As can be seen, the controllers were designed, relaxing some conflicting performance criteria: on the robust controller design the efforts were concentrated to obtain a rapid response and a rapid accommodation, in tracking references and in disturbance rejection, not worrying about the control signal amplitude, for references tracking. In fuzzy controller design the efforts were concentrated to obtain a rapid response and smaller control signals, but no major requirements for rapid accommodation, which had already been achieved by the robust controller; this way all performance requirements were satisfied through the use of the hierarchical fuzzy controller.

With the use of hierarchical control, the controller design becomes simpler because they are more specific, they do not have to meet conflicting performance criteria.

As a suggestion for future projects can be verified: other control techniques for vibration suppression and tracking reference; new ways to optimize the components of HFC; using more controllers in the composition of HFC; other methods for supervisor project; a better configuration of the proposed genetic algorithms.

Author details

Carlos André Guerra Fonseca

Informatics Department, Rio Grande do Norte State University, Natal, Brazil

Computing Engineering and Automation Department, Rio Grande do Norte Federal University, Natal, Brazil

Fábio Meneghetti Ugulino de Araújo

Computing Engineering and Automation Department, Rio Grande do Norte Federal University, Natal, Brazil

Marconi Câmara Rodrigues

Science and Technology School, Rio Grande do Norte Federal University, Natal, Brazil

7. References

- [1] Araújo FMU (2002) Automatic Intelligent Controllers with Applications in Mechanical Vibration Isolation [PhD thesis]. Sao Jose dos Campos, Brazil: Aeronautical Technology Institute.

- [2] Araújo FMU (1998) Electromechanical System for Vibration Active Control [Master thesis]. Joao Pessoa, Brazil: Paraiba Federal University.
- [3] Araújo FMU and Yoneyama T (2001) Modeling and Control of an Electromechanical Device for Vibrations Active Control. Proceedings of the II National Seminar on Control and Automation. pp.15. Salvador, Brazil.
- [4] Cruz JJ (1988) Contribution to the Study of Robust Stability for Nonlinear Multivariable Regulators [PhD thesis]. Sao Jose dos Campos, Brazil: National Institute of Space Research.
- [5] Cruz JJ (1996) Multivariable Robust Control. Sao Paulo: Publisher from Sao Paulo University.
- [6] Doyle JC and Stein G (1981) Multivariable Feedback Design: Concepts for a Classical/Modern Synthesis. IEEE Transactions on Automatic Control, Vol. AC-26, No. 1, pp. 4-16.
- [7] Zadeh LA (1965) Fuzzy set. Fuzzy Sets, Information and Control, 8, pp.338-353.
- [8] Lee CC (1990) Fuzzy Logic in Control Systems: Fuzzy Logic Controller (Part I). IEEE Transactions on Systems, Man and Cybernetics, 20(2): 404-418.
- [9] Driankov D, Hellendoorn H, Reinfrank M (1993) An Introduction to Fuzzy Control. New York: Springer-Verlag. 316 p.
- [10] Dutta S (1993) Fuzzy Logic Applications: Technological and Strategic Issues. IEEE Transactions on Engineering Management, 40(3): 237-254.
- [11] Karr CL, Gentry EJ (1993) Fuzzy Control of Ph Using Genetic Algorithms. IEEE Transactions on Fuzzy Systems, 1(1): 46-53.
- [12] Chiu S, Chand S (1993) Adaptive Traffic Signal Control Using Fuzzy Logic. Proceedings of the 2nd IEEE International Conference on Fuzzy Systems; March 1993; San Francisco, USA. Piscataway: Institute of Electrical and Electronics Engineers.
- [13] Castro JL (1995) Fuzzy Logic Controllers are Universal Approximators. IEEE Transactions on Systems, Man and Cybernetics, 25(4): 629-635.
- [14] Guerra R, Sandri S, Souza MLO (1997) Autonomous Control of Satellites Altitude Using Fuzzy Logic. In: III Brazilian Symposium on Intelligent Automation, pp.337-342, Vitoria, Brazil.
- [15] Kosko B (1992) Neural Networks and Fuzzy System. Englewood Cliffs: Prentice Hall. 449 p.
- [16] Wang L, Mendel J M (1992) Generating Fuzzy Rules by Learning from Examples. IEEE Transactions on Systems, Man, and Cybernetics, 22(6): 1414-1427.
- [17] Jang JSR (1993) ANFIS: Adaptive-Network-Based Fuzzy Inference System. IEEE Transactions on Systems, Man, and Cybernetics, 23(3): 665-685.
- [18] Lin CT (1995) A Neural Fuzzy Control System with Structure and Parameter Learning. Fuzzy Sets and Systems, (70): 183-212.
- [19] Sandri AS, Correa C (1999) Fuzzy Logic. In: V Neural Networks School, São José dos Campos, Brazil. pp.c073-c090.
- [20] Shaw IS, Simões MG (1999) Fuzzy Control and Modeling. São Paulo: FAPESP, Editora Edgard Blücher LTDA.

- [21] Tsoukalas LH, Uhrig RE (1997) *Fuzzy and Neural Approaches in Engineering*. New York: Publication, John Wiley & Sons.
- [22] Fonseca CAG, Araújo FMU, Maitelli AL, Medeiros AV (2003) Genetic Algorithms for Optimization of a Fuzzy Controller for Vibration Suppression. In: VI Brazilian Symposium on Intelligent Automation, pp. 959-963. Bauru, Brazil.
- [23] Goldberg MC and Goldberg EFG (2005) Evolutionary Computation. In: VIII Neural Networks School. Natal, Brazil.
- [24] Holland JH (1970) Robust Algorithms for Adaptation Set in a General Formal Framework. In: IEEE Symposium on Adaptive Processes Decision and Control, 17. Proceedings of the XVII IEEE Symposium on Adaptive Processes Decision and Control.
- [25] Holland JH (1975) *Adaptation in Natural and Artificial Systems*. Ann Arbor: Michigan University Press.