

# We are IntechOpen, the world's leading publisher of Open Access books Built by scientists, for scientists

5,300

Open access books available

132,000

International authors and editors

160M

Downloads

Our authors are among the

154

Countries delivered to

TOP 1%

most cited scientists

12.2%

Contributors from top 500 universities



WEB OF SCIENCE™

Selection of our books indexed in the Book Citation Index  
in Web of Science™ Core Collection (BKCI)

Interested in publishing with us?  
Contact [book.department@intechopen.com](mailto:book.department@intechopen.com)

Numbers displayed above are based on latest data collected.  
For more information visit [www.intechopen.com](http://www.intechopen.com)



# Energy, Exergy and Thermoconomics Analysis of Water Chiller Cooler for Gas Turbines Intake Air Cooling

Rahim K. Jassim<sup>1</sup>, Majed M. Alhazmy<sup>2</sup> and Galal M. Zaki<sup>2</sup>

<sup>1</sup>*Department of Mechanical Engineering Technology, Yanbu Industrial College,  
Yanbu Industrial City,*

<sup>2</sup>*Department of Thermal Engineering and Desalination Technology,  
King Abdulaziz University, Jeddah  
Saudi Arabia*

## 1. Introduction

During hot summer months, the demand for electricity increases and utilities may experience difficulty meeting the peak loads, unless they have sufficient reserves. In all Gulf States, where the weather is fairly hot year around, air conditioning (A/C) is a driving factor for electricity demand and operation schedules. The utilities employ gas turbine (GT) power plants to meet the A/C peak load. Unfortunately, the power output and thermal efficiency of GT plants decrease in the summer because of the increase in the compressor power. The lighter hot air at the GT intake decreases the mass flow rate and in turn the net output power. For an ideal GT open cycle, the decrease in the net output power is  $\sim 0.4\%$  for every 1 K increase in the ambient air temperature. To overcome this problem, air intake cooling methods, such as evaporative (direct method) and/or refrigeration (indirect method) has been widely considered [Cortes and Williams 2003].

In the direct method of evaporative cooling, the air intake cools off by contacts with a cooling fluid, such as atomized water sprays, fog or a combination of both, [Wang 2009]. Evaporative cooling has been extensively studied and successfully implemented for cooling the air intake in GT power plants in dry hot regions [Ameri *et al.* 2004, 2007, Johnson 2005, Alhazmy 2004, 2006]. This cooling method is not only simple and inexpensive, but the water spray also reduces the NO<sub>x</sub> content in the exhaust gases. Recently, Sanaye and Tahani (2010) investigated the effect of using a fog cooling system, with 1 and 2% over-spray, on the performance of a combined GT; they reported an improvement in the overall cycle heat rate for several GT models. Although evaporative cooling systems have low capital and operation cost, reliable and require moderate maintenance, they have low operation efficiency, consume large quantities of water and the impact of the non evaporated water droplets in the air stream could damage the compressor blades [Tillman *et al* 2005]. The water droplets carryover and the resulting damage to the compressor blades, limit the use of evaporative cooling to areas of dry atmosphere. In these areas, the air could not be cooled below the wet bulb temperature (WBT). Chaker *et al* (2002, 2003), Homji-meher *et al* (2002)

and Gajjar *et al* (2003) have presented results of extensive theoretical and experimental studies covering aspects of fogging flow thermodynamics, droplets evaporation, atomizing nozzles design and selection of spray systems as well as experimental data on testing systems for gas turbines up to 655 MW in a combined cycle plant.

In the indirect mechanical refrigeration cooling approach the constraint of humidity is eliminated and the air temperature can be reduced well below the ambient WBT. The mechanical refrigeration cooling has gained popularity over the evaporative method and in KSA, for example, 32 GT units have been outfitted with mechanical air chilling systems. There are two approaches for mechanical air cooling; either using vapor compression [Alhazmy (2006) and Elliott (2001)] or absorption refrigerator machines [Yang *et al* (2009), Ondryas *et al* (1991), Punwani (1999) and Kakarus *et al* (2004)]. In general, application of the mechanical air-cooling increases the net power but in the same time reduces the thermal efficiency. For example, Alhazmy *et al* (2004) showed that for a GT of pressure ratio 8 cooling the intake air from 50°C to 40°C increases the power by 3.85 % and reduces the thermal efficiency by 1.037%. Stewart and Patrick (2000) raised another disadvantage (for extensive air chilling) concerning ice formation either as ice crystals in the chilled air or as solidified layer on air compressors' entrance surfaces.

Recently, alternative cooling approaches have been investigated. Farzaneh-Gord and Deymi-Dashtebayaz (2009) proposed improving refinery gas turbines performance using the cooling capacity of refineries' natural-gas pressure drop stations. Zaki *et al* 2007 suggested a reverse Brayton refrigeration cycle for cooling the air intake; they reported an increase in the output power up to 20%, but a 6% decrease in thermal efficiency. This approach was further extended by Jassim *et al* (2009) to include the exergy analysis and show that the second law analysis improvement has dropped to 14.66% due to the components irreversibilities. Khan *et al* (2008) analyzed a system in which the turbine exhaust gases are cooled and fed back to the compressor inlet with water harvested out of the combustion products. Erickson (2003, 2005) suggested using a combination of a waste heat driven absorption air cooling with water injection into the combustion air; the concept is named the "*power fogger cycle*".

Thermal analyses of GT cooling are abundant in the literature, but few investigations considered the economics of the cooling process. A sound economic evaluation of implementing an air intake GT cooling system is quite involving. Such an evaluation should account for the variations in the ambient conditions (temperature and relative humidity) and the fluctuations in the fuel and electricity prices and interest rates. Therefore, the selection of a cooling technology (evaporative or refrigeration) and the sizing out of the equipment should not be based solely on the results of a thermal analysis but should include estimates of the cash flow. Gareta *et al* (2004) has developed a methodology for combined cycle GT that calculated the additional power gain for 12 months and the economic feasibility of the cooling method. From an economical point of view, they provided straight forward information that supported equipment sizing and selection. Chalker *et al* (2003) have studied the economical potential of using evaporative cooling for GTs in USA, while Hasnain (2002) examined the use of ice storage methods for GTs' air cooling in KSA. Yang *et al* (2009) presented an analytical method for evaluating a cooling technology of a combined cycle GT that included parameters such as the interest rate,

payback period and the efficiency ratio for off-design conditions of both the GT and cooling system. Investigations of evaporative cooling and steam absorption machines showed that inlet fogging is superior in efficiency up to intake temperatures of 15-20°C, though it results in a smaller profit than inlet air chilling [Yang *et al* 2009].

In the present study, the performance of a cooling system that consists of a chilled water external loop coupled to the GT entrance is investigated. The analysis accounts for the changes in the thermodynamics parameters (applying the first and second law analysis) as well as the economic variables such as profitability, cash flow and interest rate. An objective of the present study is to assess the importance of using a coupled thermo-economics analysis in the selections of the cooling system and operation parameters. The developed algorithm is applied to an open cycle, HITACH MS-7001B plant in the hot weather of KSA (Latitude 24° 05" N and longitude 38° E) by The result of this case study are presented and discussed.

## 2. GT-air cooling chiller energy analysis

Figure 1.a shows a schematic of a simple open GT "Brayton cycle" coupled to a refrigeration system. The power cycle consists of a compressor, combustion chamber and a turbine. It is presented by states 1-2-3-4 on the T-S diagram, Fig. 1.b. The cooling system consists of a refrigerant compressor, air cooled condenser, throttle valve and water cooled evaporator. The chilled water from the evaporator passes through a cooling coil mounted at the air compressor entrance, Fig. 1.a. The refrigerant cycle is presented on the T-S diagram, Figure 1.c, by states *a*, *b*, *c* and *d*. A fraction of the power produced by the turbine is used to power the refrigerant compressor and the chilled water pumps, as indicated by the dotted lines in Fig. 1.a. To investigate the performance of the coupled GT-cooling system the different involved cycles are analyzed in the following employing the first and second laws of thermodynamics.

### 2.1 Gas turbine cycle

As seen in Figures 1.a and 1.b, processes 1-2<sub>s</sub> and 3-4<sub>s</sub> are isentropic. Assuming the air as an ideal gas, the temperatures and pressures are related to the pressure ratio, *PR*, by:

$$\frac{T_{2s}}{T_1} = \frac{T_3}{T_{4s}} = \left[ \frac{P_2}{P_1} \right]^{\frac{k-1}{k}} = PR^{\frac{k-1}{k}} \quad (1)$$

The net power output of a GT with mechanical cooling system as seen in Fig. 1.a is

$$\dot{W}_{net} = \dot{W}_t - (\dot{W}_{comp} + \dot{W}_{el,ch}) \quad (2)$$

The first term of the RHS is the power produced by the turbine due to expansion of hot gases;

$$\dot{W}_t = \dot{m}_t c_{pg} \eta_t (T_3 - T_{4s}) \quad (3)$$

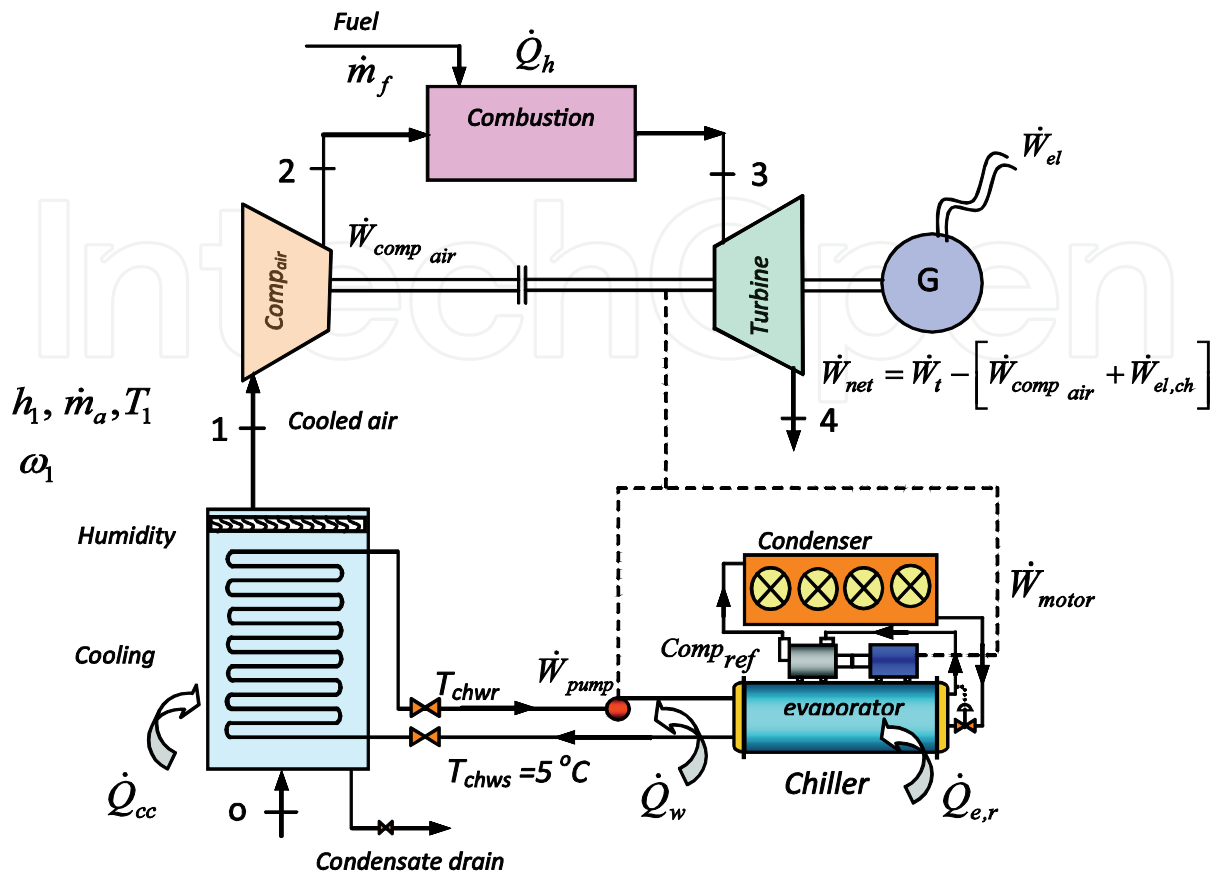

Fig. 1a. Simple open type gas turbine with a chilled air-cooling unit

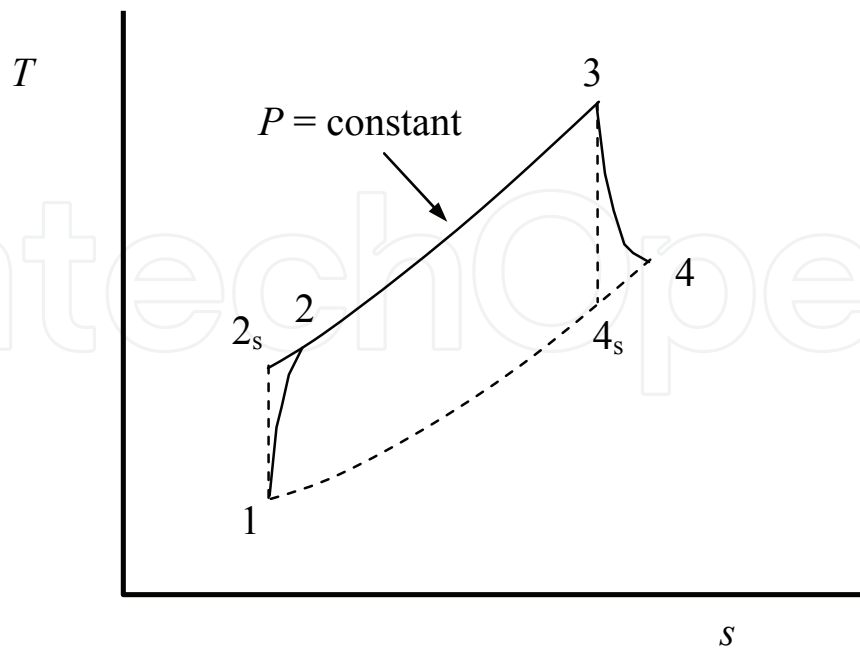

Fig. 1b. T-s diagram of an open type gas turbine cycle

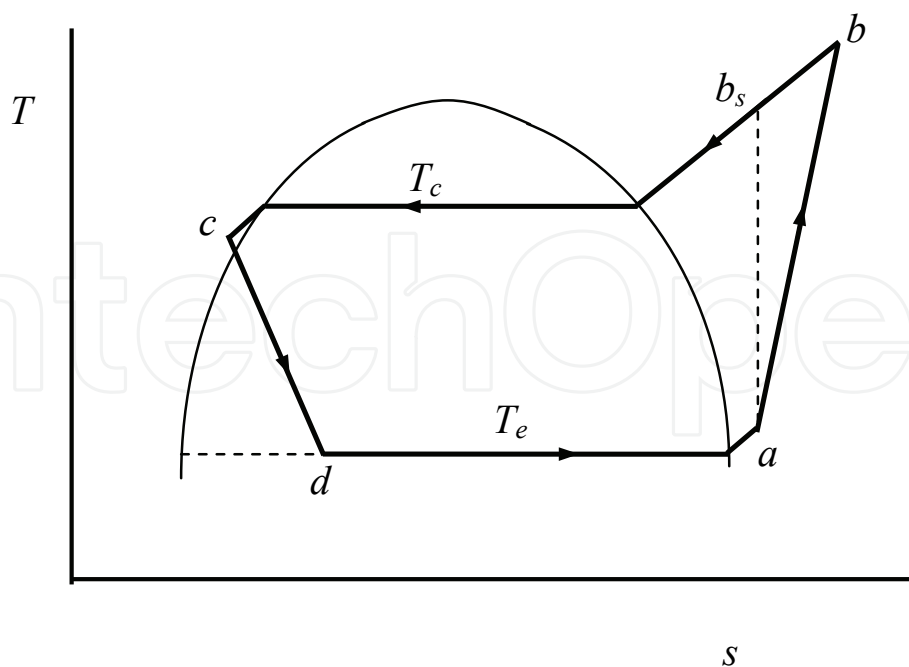

Fig. 1c.  $T$ - $s$  diagram for a refrigeration machine

In Eq.3,  $\dot{m}_t$  is the total gases mass flow rate from the combustion chamber; expressed in terms of the fuel air ratio  $f = \dot{m}_f / \dot{m}_a$ , and the air humidity ratio at the compressor intake  $\omega_1$ , ( $\text{kg}_w / \text{kg}_{dry\ air}$ ) (Fig. 1.a) as;

$$\dot{m}_t = \dot{m}_a + \dot{m}_v + \dot{m}_f = \dot{m}_a(1 + \omega_1 + f) \quad (4)$$

The compression power for humid air between states 1 and 2 is estimated from:

$$\dot{W}_{comp} = \dot{m}_a c_{pa} (T_2 - T_1) + \dot{m}_v (h_{v2} - h_{v1}) \quad (5)$$

where  $h_{v2}$  and  $h_{v1}$  are the enthalpies of saturated water vapor at the compressor exit and inlet states respectively,  $\dot{m}_v$  is the mass of water vapor =  $\dot{m}_a \omega_1$ .

The last term in Eq. 2 ( $\dot{W}_{el,ch}$ ) is the power consumed by the cooling unit for driving the refrigeration machine electric motor, pumps and auxiliaries.

The thermal efficiency of a GT coupled to an air cooling system is then;

$$\eta_{cy} = \frac{\dot{W}_t - (\dot{W}_{comp} + \dot{W}_{el,ch})}{\dot{Q}_h} \quad (6)$$

Substituting for  $T_{4s}$  and  $\dot{m}_t$  from Equations (1) and (4) into Eq. (3) yields:

$$\dot{W}_t = \dot{m}_a(1 + \omega_1 + f)c_{pg} \eta_t T_3 \left( 1 - \frac{1}{PR^{\frac{k-1}{k}}} \right) \quad (7)$$

The turbine isentropic efficiency,  $\eta_t$ , can be estimated using the practical relation recommended by Alhazmy and Najjar (2004):

$$\eta_t = 1 - \left( 0.03 + \frac{PR - 1}{180} \right) \quad (8)$$

Relating the compressor isentropic efficiency to the changes in temperature of the dry air and assuming that the compression of water vapor changes the enthalpy; the actual compressor power becomes;

$$\dot{W}_{compair} = \dot{m}_a \left[ c_{pa} \frac{T_1}{\eta_c} \left( PR^{\frac{k-1}{k}} - 1 \right) + \omega_1 (h_{v2} - h_{v1}) \right] \quad (9)$$

The compression efficiency,  $\eta_c$ , can be evaluated using the following empirical relation, Alhazmy and Najjar (2004);

$$\eta_c = 1 - \left( 0.04 + \frac{PR - 1}{150} \right) \quad (10)$$

The heat balance in the combustion chamber (Fig. 1.a) gives the heat rate supplied to the gas power cycle as:

$$\dot{Q}_h = \dot{m}_f NCV \eta_{comb} = (\dot{m}_a + \dot{m}_f) c_{pg} T_3 - \dot{m}_a c_{pa} T_2 + \dot{m}_v (h_{v3} - h_{v2}) \quad (11)$$

Introducing the fuel air ratio  $f = \dot{m}_f / \dot{m}_a$  and substituting for  $T_2$  in terms of  $T_1$  into Eq.11 yields:

$$\dot{Q}_h = \dot{m}_a T_1 \left[ (1 + f) c_{pg} \frac{T_3}{T_1} - c_{pa} \left( \frac{PR^{\frac{k-1}{k}} - 1}{\eta_c} + 1 \right) + \frac{\omega_1}{T_1} (h_{v3} - h_{v2}) \right] \quad (12)$$

A simple expression for  $f$  is selected here, Alhazmy *et.al* (2006) as:

$$f = \frac{c_{pg} (T_3 - 298) - c_{pa} (T_2 - 298) + \omega_1 (h_{v3} - h_{v2})}{NCV \eta_{comb} - c_{pg} (T_3 - 298)} \quad (13)$$

In equation 13,  $h_{v2}$  and  $h_{v3}$  are the enthalpies of water vapor at the combustion chamber inlet and exit states respectively and can be calculated from Eq. 14, Dossat (1997).

$$h_{v,j} = 2501.3 + 1.8723 T_j \quad j \text{ refers to states 2 or 3} \quad (14)$$

The four terms of the gas turbine net power and efficiency in Eq. (6) ( $\dot{W}_t$ ,  $\dot{W}_{comp}$ ,  $\dot{W}_{el, ch}$  and  $\dot{Q}_h$ ) depend on the air temperature and relative humidity at the compressor inlet whose values are affected by the type and performance of the cooling system. The chillers' electric power,  $\dot{W}_{el, ch}$ , is calculated in the following account.

## 2.2 Refrigeration cooling system analysis

The chilled water from the refrigeration machine is the heat transport fluid to cool the intake air, Fig. 1.a. The chiller's total electrical power can be expressed as the sum of the electric motor power ( $\dot{W}_{motor}$ ), the pumps ( $\dot{W}_p$ ) and auxiliary power for fans and control units, ( $\dot{W}_A$ ) as:

$$\dot{W}_{el,chl} = \dot{W}_{motor} + \dot{W}_p + \dot{W}_A \quad (15)$$

The auxiliary power is estimated as 10% of the compressor power, therefore,  $\dot{W}_A = 0.1 \dot{W}_{motor}$ . The second term in Eq. 15 is the pumping power that is related to the chilled water flow rate and the pressure drop across the cooling coil, so that:

$$\dot{W}_p = \dot{m}_{cw} v_f (\Delta P) / \eta_{pump} \quad (16)$$

The minimum energy utilized by the refrigerant compressor is that for the isentropic compression process ( $a-b_s$ ), Fig 1.c. The actual power includes losses due to mechanical transmission, inefficiency in the drive motor converting electrical to mechanical energy and the volumetric efficiency, Dossat (1997). The compressor electric motor work is related to the refrigerant enthalpy change as

$$\dot{W}_{motor} = \frac{\dot{m}_r (h_b - h_a)_r}{\eta_{eu}} \quad (17)$$

The subscript  $r$  indicates refrigerant and  $\eta_{eu}$  known as the energy use factor;  $\eta_{eu} = \eta_m * \eta_{el} * \eta_{vo}$ . The quantities on the right hand side are the compressor mechanical, electrical and volumetric efficiencies respectively.  $\eta_{eu}$  is usually determined by manufacturers and depends on the type of the compressor, the pressure ratio ( $P_b / P_a$ ) and the motor power. For the present analysis  $\eta_{eu}$  is assumed 85%.

Cleland *et al* (2000) developed a semi-empirical form of Equation 17 to calculate the compressor's motor power usage in terms of the temperatures of the evaporator and condenser in the refrigeration cycle,  $T_e$  and  $T_c$  respectively as;

$$\dot{W}_{motor} = \frac{\dot{m}_r (h_a - h_d)_r}{\frac{T_e}{(T_c - T_e)} (1 - \alpha x)^n \eta_{eu}} \quad (18)$$

In this equation,  $\alpha$  is an empirical constant that depends on the type of refrigerant and  $x$  is the quality at state  $d$ , Fig 1.c. The empirical constant is 0.77 for R-22 and 0.69 for R-134a Cleland *et al* (2000). The constant  $n$  depends on the number of the compression stages; for a simple refrigeration cycle with a single stage compressor  $n = 1$ . The nominator of Eq. 18 is the evaporator capacity,  $\dot{Q}_{e,r}$  and the first term of the denominator is the coefficient of performance of an ideal refrigeration cycle. Equations 2, 5 and 18 could be solved for the power usages by the different components of the coupled GT-refrigeration system to estimate the increase in the power output as function of the air intake conditions. Follows is a thermodynamics second law analysis to estimate the effect of irreversibilities on the power gain and efficiency.



### 3. Exergy analysis

In general, the expression for the exergy destruction, (Kotas 1995), is.

$$\dot{I} = T_o \left[ (\dot{S}_{out} - \dot{S}_{in}) - \sum_{i=1}^n \frac{\dot{Q}_i}{T_i} \right] \geq 0 \quad (19)$$

and the exergy balance for any component of the coupled GT and refrigeration cooling cycle (Fig.1) is expressed as;

$$\dot{E}_{in} + \dot{E}^Q = \dot{E}_{out} + \dot{W} + \dot{I} \quad (20)$$

Various amounts of the exergy destruction terms due to irreversibility for each component in the gas turbine and the proposed air cooling system are given in final expressions, Table 1. Details of derivations can be found in Jassim, *et al* (2005 & 2009) and Khir *et.al* 2007.

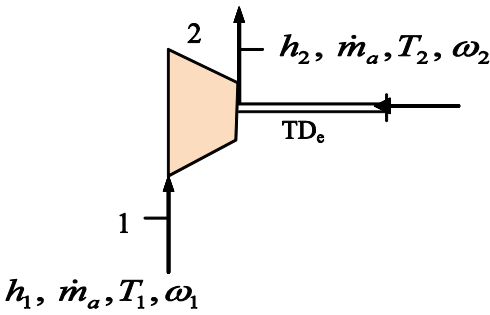
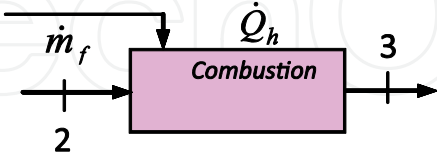
<p><b>Air Compressor</b></p>  <p>Air compressor process 1-2, Fig. 1-b</p>	$\dot{I}_{comp,air} = \dot{m}_a (1 + \omega_1) T_o \left[ c_{pa} \ln \left( \frac{T_2}{T_1} \right) - R_a \ln \left( \frac{P_2}{P_1} \right) \right] \quad (21)$ $\dot{W}_{eff,comp} = \dot{W}_{comp} + \dot{I}_{comp} \quad (22)$
<p><b>Combustion chamber</b></p> 	$\dot{I}_{comb\ chamber} = \dot{m}_a T_o \left\{ \begin{array}{l} (1 + f + \omega_1) \left[ c_{pg} \ln \left( \frac{T_3}{T_o} \right) - R_g \ln \left( \frac{P_3}{P_o} \right) \right] - \\ (1 + \omega_1) \left[ c_{pa} \ln \left( \frac{T_2}{T_o} \right) - R_a \ln \left( \frac{P_2}{P_o} \right) \right] \end{array} \right\} + T_o \Delta S_o \quad (23)$ <p><math>T_o \Delta S_o</math> = rate of exergy loss in combustion or reaction = <math>\dot{m}_a \times f \times NCV (\phi - 1)</math></p>

Typical values of  $\phi$  for some industrial fuels are given by Jassim *et al*, 2009, the effective heat to the combustion chamber

$$\dot{Q}_{eff,comb} = \dot{Q}_{comb} + \dot{I}_{comb} \quad (24)$$

**Gas turbine**

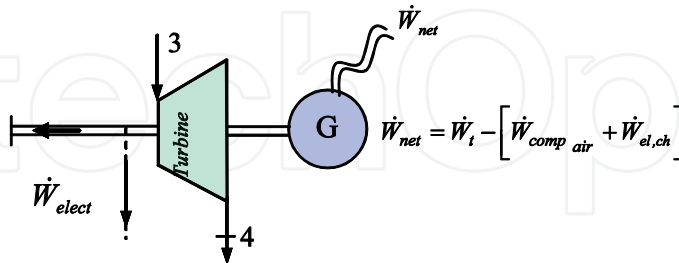

$$\dot{I}_{gasturbine} = \dot{m}_a (1 + f + \omega_1) T_0 \left[ c_{pg} \ln \left( \frac{T_4}{T_3} \right) - R_g \ln \left( \frac{P_4}{P_3} \right) \right] \quad (25)$$

$$\dot{W}_{eff,t} = \dot{W}_t - \dot{I}_t \quad (26)$$

**Chiller compressor**

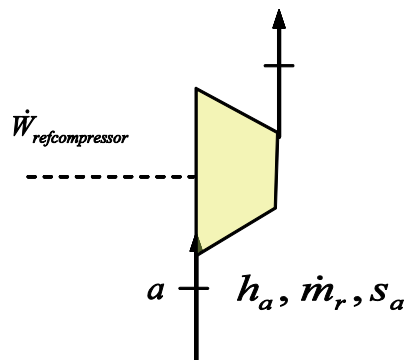

$$\dot{I}_{ref\ comp} = \dot{m}_r T_0 (s_b - s_a) \quad (27)$$

**Chiller Condenser**

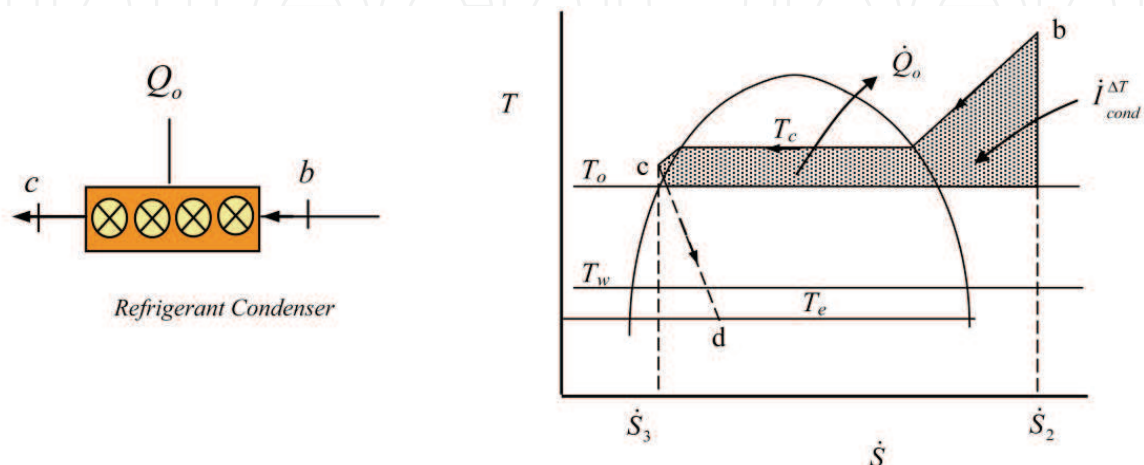

$$\dot{i}_{cond}^{\Delta T} = \dot{m}_r T_o \left[ (s_c - s_b) + \frac{(h_b - h_c)}{T_o} \right] \quad (28)$$

The condenser flow is divided into three regions: superheated vapor region, two phase (saturation) region, and subcooled liquid region for which the exergy destruction due to flow pressure losses in each region are  $\dot{i}_{cond,sup}^{\Delta P}$ ,  $\dot{i}_{cond,sat}^{\Delta P}$  and  $\dot{i}_{cond,sub}^{\Delta P}$ . (Jassim *et al* 2005)

$$\dot{i}_{cond}^{\Delta P} = \dot{i}_{cond,sup}^{\Delta P} + \dot{i}_{cond,sat}^{\Delta P} + \dot{i}_{cond,sub}^{\Delta P} \quad (29)$$

$$\dot{i}_{cond} = \dot{i}_{cond}^{\Delta T} + \dot{i}_{cond}^{\Delta P} \quad (30)$$

**Chiller cooling coil**

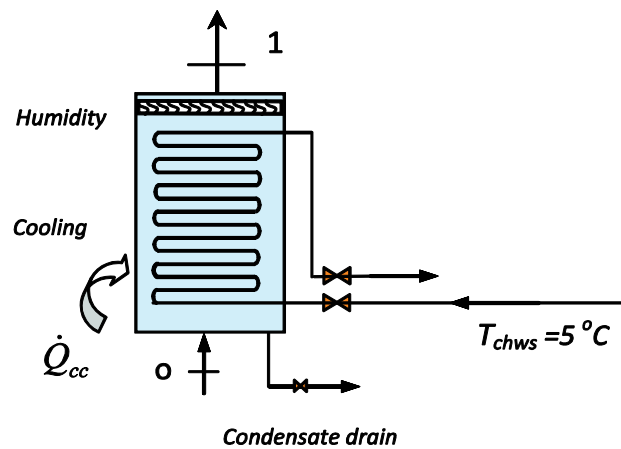

$$\dot{i}_{cooling\ coil} = \dot{m}_a (1 + \omega_1) T_o (s_o - s_1) + \dot{Q}_{out} \quad (31)$$

**Expansion valve**

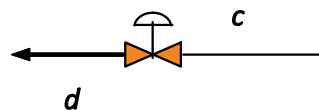

$$\dot{i}_{exp} = \dot{m}_r T_o [(s_d - s_c)] \quad (32)$$

**Refrigerant evaporator**

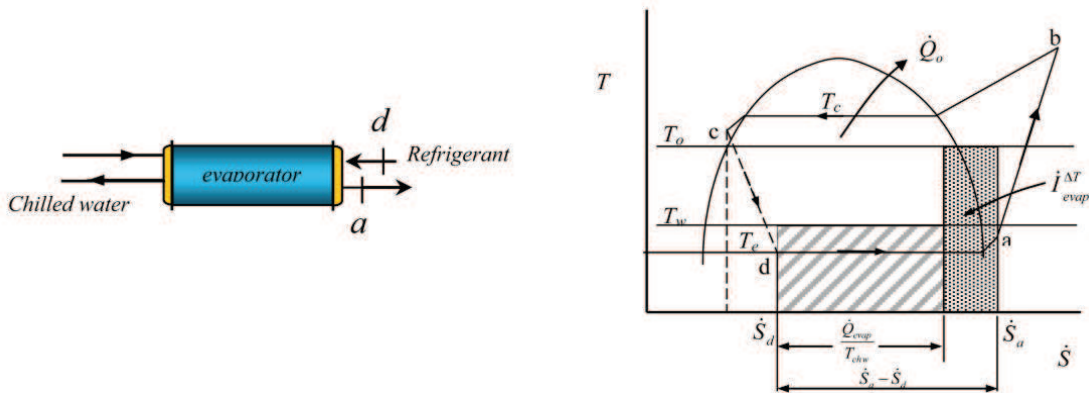

$$\dot{i}_{evap}^{\Delta T} = \dot{m}_r T_o \left[ (s_a - s_d) - \frac{(h_a - h_d)}{T_{sw}} \right] \quad (33)$$

The refrigerant flow in the evaporator is divided into two regimes saturation (two phase) and superheated regions. The two phase (saturation) region, and superheated vapor region for which the exergy destruction due to flow pressure losses in each region are  $\dot{i}_{evap,sat}^{\Delta P}$  and  $\dot{i}_{evap,sup}^{\Delta P}$  see Khir *et al* 2007. The exergy destruction rate is the sum of the thermal and pressure loss terms for both regimes (Eqs. 34 and 35) as,

$$\dot{i}_{evap} = \dot{i}_{evap}^{\Delta T} + \dot{i}_{evap}^{\Delta P} \quad (34)$$

$$\dot{i}_{evap}^{\Delta P} = \dot{i}_{evap,sat}^{\Delta P} + \dot{i}_{evap,sup}^{\Delta P} \quad (35)$$

Table 1. Exergy destruction terms for the individual components of the GT and coupled cooling chilled water unit, see Figs 1.a-1.c

#### 4. Economics analysis

The increase in the power output due to intake air cooling will add to the revenue of the GT plant but will partially offset by the increase of the annual payments associated with the installation, personnel and utility expenditures for the operation of that system. For a cooling unit that includes a water chiller, the increase in expenses include the capital installments for the chiller,  $(C_{ch}^c)$ , and cooling coil,  $(C_{cc}^c)$ . The annual operation expenses is a function of the operation period,  $t_{op}$ , and the electricity rate. If the chiller consumes electrical power  $\dot{W}_{el,ch}$  and the electricity rate is  $C_{el}$  (\$/kWh) then the total annual expenses can be expressed as:

$$C_{total} = a^c [C_{ch}^c + C_{cc}^c] + \int_0^{t_{op}} C_{el} \dot{W}_{el,ch} dt \quad (\$/y) \quad (36)$$

In equation 36, the capital recovery factor  $a^c = \frac{i(1+i)^n}{(1+i)^n - 1}$ , which when multiplied by the total investment gives the annual payment necessary to payback the investment after a specified period ( $n$ ).

The chiller's purchase cost may be estimated from vendors data or mechanical equipment cost index; this cost is related to the chiller's capacity,  $\dot{Q}_{e,r}$  (kW). For a particular chiller size and method of construction and installation; the capital cost is usually given by manufacturers in the following form;

$$C_{ch}^c = \alpha_{ch} \dot{Q}_{e,r} \quad (37)$$

For simplicity, the maintenance expenses are assumed as a fraction,  $\alpha_m$ , of the chiller capital cost, therefore, the total chiller cost is expressed as;

$$C_{ch}^c = \alpha_{ch} (1 + \alpha_m) \dot{Q}_{e,r} \quad (\$) \quad (38)$$

Similarly, the capital cost of a particular cooling coil is given by manufacturers in terms of the cooling capacity that is directly proportional to the total heat transfer surface area ( $A_{cc}$ , m<sup>2</sup>) Kotas (1995) as;

$$C_{cc}^c = \beta_{cc} (A_{cc})^m \quad (\$) \quad (39)$$

In equation 39,  $\beta_{cc}$  and  $m$  depend on the type of the cooling coil and material. For the present study and local Saudi market,  $\beta_{cc} = 30000$  and  $m = 0.582$  are recommended (York Co consultation, 2009). Substituting equations 38 and 39 into Eq. 36, assuming for simplicity that the chiller power is an average constant value and constant electricity rate over the operation period, the annual total expenses for the cooling system become;

$$C_{total} = a^c \left[ \alpha_{ch} (1 + \alpha_m) \dot{Q}_{e,r} + \beta_{cc} (A_{cc})^m \right] + t_{op} C_{el} \dot{W}_{el,ch} \quad (\$/y) \quad (40)$$

In Eq. 40 the heat transfer area  $A_{cc}$  is the parameter used to evaluate the cost of the cooling coil. Energy balance on both the cooling coil and the refrigerant evaporator, taking into account the effectiveness factors for the evaporator,  $\epsilon_{eff,er}$ , and the cooling coil,  $\epsilon_{eff,cc}$ , gives

$$A_{cc} = \frac{\dot{Q}_{cc}}{U \Delta T_m F \epsilon_{eff,cc}} = \frac{\dot{Q}_{e,r} \epsilon_{eff,er}}{U \Delta T_m F} \quad (41)$$

Where,  $U$  is the overall heat transfer coefficient for chilled water-air tube bank heat exchanger. Garetta, *et al* (2004) suggested a moderate value of 64 W/m<sup>2</sup> K and 0.98 for the correction factor  $F$ .

Figure 2, illustrates the temperature variations in the combined refrigerant, water chiller and air cooling system. the mean temperature difference for the cooling coil (air and chilled water fluids) is;

$$\Delta T_m = \frac{(T_o - T_{chwr}) - (T_1 - T_{chws})}{\ln((T_o - T_{chwr}) / (T_1 - T_{chws}))} \quad (42)$$

Equations 39 and 41 give the cooling coil cost as,

$$C_{cc}^c = \beta_{cc} \left( \frac{\dot{Q}_{cc}}{U \Delta T_m F} \right)^m \quad (43)$$

where,  $\dot{Q}_{cc}$  is the thermal capacity of the cooling coil. The atmospheric air enters at  $T_o$  and  $\omega_o$  and leaves the cooling coil to enter the air compressor intake at  $T_1$  and  $\omega_1$ , Fig.1.a. Both  $T_1$  and  $\omega_1$  depend on the chilled water supply temperature ( $T_{chws}$ ) and mass flow rate,  $\dot{m}_{cw}$ . When the outer surface temperature of the cooling coil falls below the dew point (corresponding to the partial pressure of the water vapor) the water vapor condensates and leaves the air stream. This process may be treated as a cooling-dehumidification process as illustrated in Figure 3. Steady state heat balance of the cooling coil gives;

$$\dot{Q}_{cc} = \dot{m}_a (h_o - h_1) - \dot{m}_w h_w = \dot{m}_{cw} c_w \varepsilon_{eff,cc} (T_{chwr} - T_{chws}) \quad (44)$$

where,  $\dot{m}_{cw}$  is the chilled water mass flow rate and  $\dot{m}_w$  is the rate of water extraction from the air,  $\dot{m}_w = \dot{m}_a (\omega_o - \omega_1)$ . The second term in equation 44 is usually a small term when compared to the first and can be neglected, McQuiston *et al* (2005).

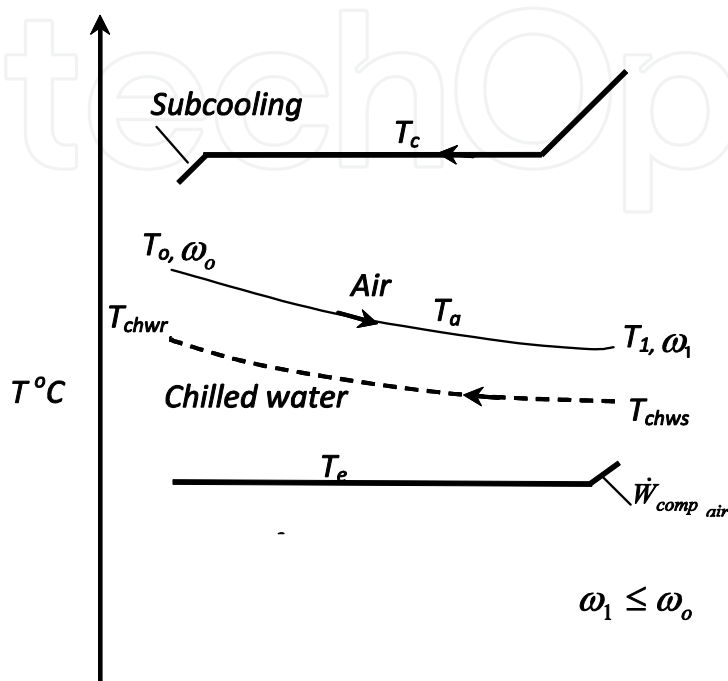

Fig. 2. Temperature levels for the three working fluids, not to scale

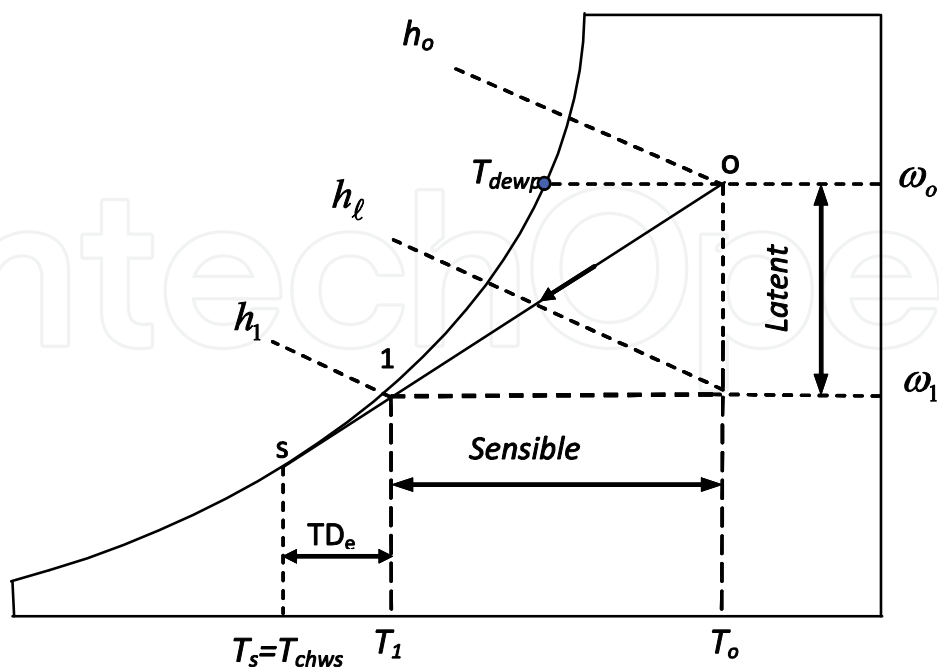

Fig. 3. Moist air cooling process before GT compressor intake

In equation 44 the enthalpy and temperature of the air leaving the cooling coil ( $h_1$  and  $T_1$ ) may be calculated from;

$$h_1 = h_o - CF(h_o - h_s) \quad (45)$$

$$T_1 = T_o - CF(T_o - T_s) \quad (46)$$

The contact factor  $CF$  is defined as the ratio between the actual air temperature drop to the maximum, at which the air theatrically leaves at the coil surface temperature  $T_s = T_{chws}$  and 100% relative humidity. Substituting for  $h_1$  from Eq. 45 into Eq. 44 and use Eq. 41 gives;

$$\dot{Q}_{e,r} = \frac{\dot{m}_a [CF(h_o - h_{chws}) - (\omega_o - \omega_1)h_w]}{\epsilon_{eff,er} \epsilon_{eff,cc}} \quad (47)$$

Equations 40 through 47 give the chiller and cooling coil annual expenses in terms of the air mass flow rate and properties. The total annual cost function is derived from Eq. 40 as follows.

#### 4.1 Annual cost function

Combining equations 40 and 41, substituting for the cooling coil surface area, pump and auxiliary power gives the total annual cost in terms of the evaporator capacity  $\dot{Q}_{er}$ , as,

$$C_{total} = \left\{ a^c \left[ \alpha_{ch} (1 + \alpha_m) \dot{Q}_{er} + \beta_{cc} \left( \frac{\dot{Q}_{er} \epsilon_{eff,er} \epsilon_{eff,cc}}{U \Delta T_m F} \right)^m \right] + t_{op} \dot{Q}_{er} C_{el} \left[ \left( \frac{1.1(T_c - T_e)}{T_e (1 - \alpha x)^n \eta_{eu}} \right) + \left( \frac{\epsilon_{eff,er} v_f (\Delta P)}{c_{p,w} \Delta T_{ch,w} \eta_{pump}} \right) \right] \right\} \quad (48)$$

The first term in Eq. 48 is the annual fixed charges of the refrigeration machine and the surface air cooling coil, while the second term is the operation expenses that depend mainly on the electricity rate. If the water pump's power is considered small compared to the compressor power, the second term of the operation charges can be dropped. If the evaporator capacity  $\dot{Q}_{er}$  is replaced by the expression in Eq. 47, the cost function, in terms of the primary parameters, becomes;

$$C_{total} = \left[ \frac{\dot{m}_a [CF(h_o - h_{chws}) - (\omega_o - \omega_1)h_w]}{\epsilon_{eff,er} \epsilon_{eff,cc}} \right] \left\{ a^c \left[ \alpha_{ch} (1 + \alpha_m) + \beta_{cc} \left( \frac{\epsilon_{eff,er} \epsilon_{eff,cc}}{U \Delta T_m F} \right)^m \times \left( \frac{\dot{m}_a [CF(h_o - h_{chws}) - (\omega_o - \omega_1)h_w]}{\epsilon_{eff,er} \epsilon_{eff,cc}} \right)^{m-1} \right] + t_{op} C_{el} \left[ \left( \frac{1.1(T_c - T_e)}{(T_e)(1 - \alpha x)^n \eta_{eu}} \right) + \left( \frac{\epsilon_{eff,er} v_f (\Delta P)}{c_{p,w} \Delta T_{ch,w} \eta_p} \right) \right] \right\} \quad (49)$$

## 5. Evaluation criteria of GT-cooling system

In order to evaluate the feasibility of a cooling system coupled to a GT plant, the performance of the plant is examined with and without the cooling system. In the present study it is recommended to consider the results of the three procedures (energy, exergy and economics analysis).

### 5.1 First law efficiency

In general, the net power output of a complete system is given in Eq. 2 in terms of  $\dot{W}_t$ ,  $\dot{W}_{comp}$  and  $\dot{W}_{el,ch}$ . The three terms are functions of the air properties at the compressor intake ( $T_1$  and  $\omega_1$ ), which in turn depend on the performance of the cooling system. The present analysis considers the "power gain ratio" (PGR), a broad term suggested by AlHazmy *et al* (2006) that takes into account the operation parameters of the GT and the associated cooling system:

$$PGR = \frac{\dot{W}_{net,withcooling} - \dot{W}_{net,withoutcooling}}{\dot{W}_{net,withoutcooling}} \times 100\% \quad (50)$$

For a stand-alone GT,  $PGR = 0$ . Thus, the  $PGR$  gives the percentage enhancement in power generation by the coupled system. The thermal efficiency of the system is an important parameter to describe the input-output relationship. The *thermal efficiency change factor* (TEC) proposed in AlHazmy *et al* (2006) is defined as

$$TEC = \frac{\eta_{cy,withcooling} - \eta_{cy,withoutcooling}}{\eta_{cy,withoutcooling}} \times 100\% \quad (51)$$

### 5.2 Exergetic efficiency

Exergetic efficiency is a performance criterion for which the output is expressible in terms of exergy. Defining the exergetic efficiency  $\eta_{ex}$ , as a ratio of total rate of exergy output ( $\dot{E}_{out}$ ) to total rate of exergy input ( $\dot{E}_{in}$ ) as;

$$\eta_{ex} = \frac{\dot{E}_{out}}{\dot{E}_{in}} \quad (52)$$

The exergy balance for the gas turbine and the water chiller system, using the effective work and heat terms in Table 1, can be expressed in the following forms,

$$\dot{E}_{out} = \dot{W}_{eff,t} - \dot{W}_{eff,comp} - \dot{W}_{eff,Chiller} \quad (53)$$

and

$$\dot{E}_{in} = \dot{Q}_{eff,comb} - \dot{Q}_{eff,cc} \quad (54)$$

In analogy with the energy efficiency the exergetic efficiency for a GT-refrigeration unit is:



$$\eta_{ex,c} = \frac{\dot{W}_{eff,t} - \dot{W}_{eff,comp} - \dot{W}_{eff,chiller}}{\dot{Q}_{eff,comb} - \dot{Q}_{eff,cc}} \quad (55)$$

For the present analysis let us define dimensionless terms as the *exergetic power gain ratio* ( $PGR_{ex}$ ) and *exergetic thermal efficiency change* ( $TEC_{ex}$ ):

$$PGR_{ex} = \frac{(\dot{E}_{out})_{withcooling} - (\dot{E}_{out})_{withoutcooling}}{(\dot{E}_{out})_{withoutcooling}} \times 100\% \quad (56)$$

and

$$TEC_{ex} = \frac{\eta_{ex,c} - \eta_{ex,nc}}{\eta_{ex,nc}} \times 100\% \quad (57)$$

Equations 50, 51, 56 and 57 can be easily employed to appraise the changes in the system performance, but they are not sufficient for a complete evaluation of the cooling method, the economics assessment of installing a cooling system follows.

### 5.3 System profitability

To investigate the economic feasibility of retrofitting a gas turbine plant with an intake cooling system, the total cost of the cooling system is determined (Eq. 32 or Eq. 33). The increase in the *annual* income cash flow from selling the additional electricity generation is also calculated. The annual exported energy by the coupled power plant system is;

$$E (kWh) = \int_0^{t_{op}} \dot{W}_{net} dt \quad (58)$$

If the gas turbine's annual electricity generation without the cooling system is  $E_{without cooling}$  and the cooling system increases the power generation to  $E_{with cooling}$ , then the net increase in revenue due to the addition of the cooling system is:

$$Net\ revenue = (E_{with\ cooling} - E_{without\ cooling})C_{els} \quad (59)$$

The profitability due to the coupled power plant system is defined as the increase in revenues due to the increase in electricity generation after deducting the expenses for installing and operating the cooling system as:

$$profitability = (E_{with\ cooling} - E_{without\ cooling})C_{els} - C_{total} \quad (60)$$

The first term in Eq. 60 gives the increase in revenue and the second term gives the annual expenses of the cooling system. The profitability could be either positive, which means an economical incentive for adding the cooling system, or negative, meaning that there is no economical advantage, despite the increase in the electricity generation of the plant.

For more accurate evaluation the irreversibility of the different components are taken into consideration and an effective revenue ( $Revenue_{eff}$ ) is defined by;

$$Revenue_{eff} = \int_0^{t_{op}} \left( (\dot{E}_{out})_{with\ cooling} - (\dot{E}_{out})_{without\ cooling} \right) C_{els} dt \quad (61)$$

### 6. Results and discussion

The performance of the GT with water chiller cooler and its economical feasibility are investigated. The selected site is the Industrial City of Yanbu (Latitude 24° 05' N and longitude 38° E) where a HITACH FS-7001B model GT plant is already connected to the main electric grid. Table 2 lists the main specs of the selected GT plant. The water chiller capacity is selected on basis of the maximum annual ambient temperature at the site. On August 18<sup>th</sup>, 2008, the dry bulb temperature (DBT) reached 50°C at 14:00 O'clock and the relative humidity was 84% at dawn time. The recorded hourly variations in the DBT ( $T_o$ ) and  $RH_o$  are shown in Figure 4 and the values are listed in Table 2. Eq. 47 gives the evaporator capacity of the water chiller (Ton Refrigeration) as function of the DBT and  $RH$ . Figure 5 shows that if the chiller is selected based on the maximum DBT = 50°C and RH = 18%, (the data at 14: O'clock), its capacity would be 2200 Ton. Another option is to select the chiller capacity based on the maximum  $RH_o$  ( $RH_o = 0.83$  and  $T_o = 28.5^\circ\text{C}$ , 5:00 data), which gives 3500 Ton. It is more accurate, however, to determine the chiller capacity for the available climatic data of the selected day and determine the maximum required capacity, as seen in Fig. 6; for the weather conditions at Yanbu City, a chiller capacity of 4200 Ton is selected it is the largest chiller capacity ( $\dot{Q}_{e,r}$ ) to handle the worst scenario as shown in Fig. 6.

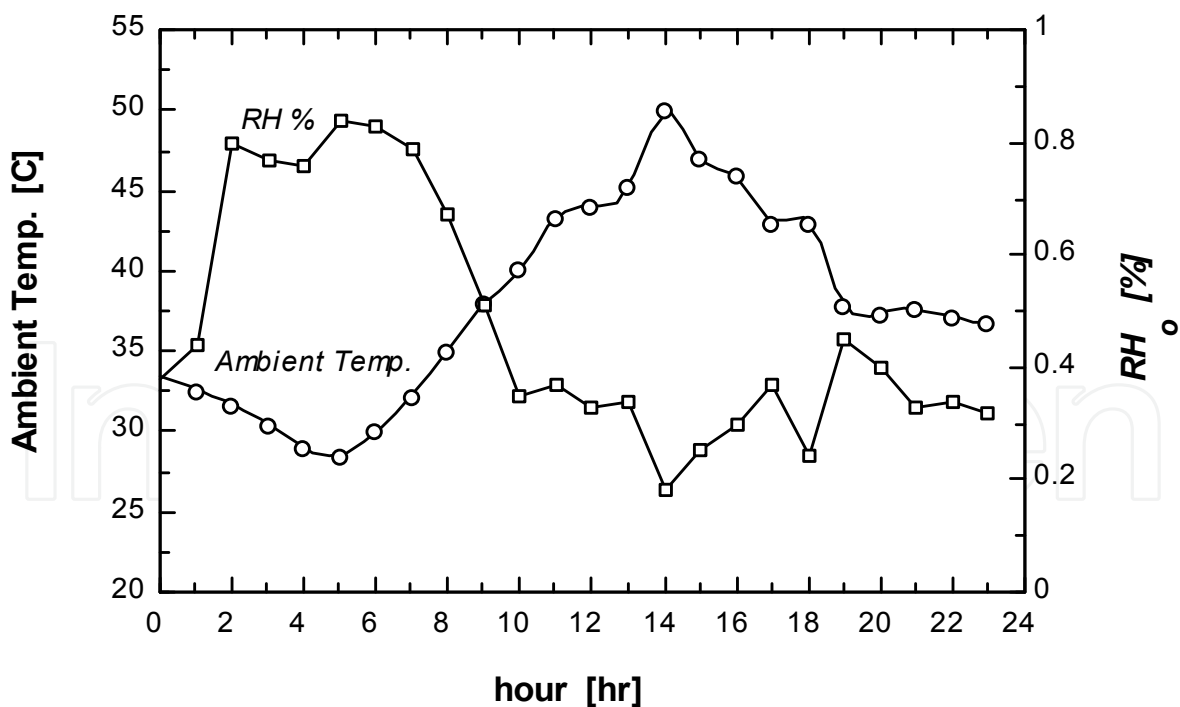

Fig. 4. Ambient temperature variation and RH for 18<sup>th</sup> of August 2008 of Yanbu Industrial City

Equations 45 and 46 are employed to give the air properties leaving the cooling coil, assuming 0.5 contact factor and a chilled water supply temperature of 5°C. All thermo-physical properties are determined to the accuracy of the Engineering Equation Solver (EES)

software [Klein and Alvarado 2004]. The result show that the cooling system decrease the intake air temperature from  $T_o$  to  $T_1$  and increases the relative humidity to  $RH_1$  (Table 3).

Parameter	Range
<i>Ambient air, Fig. 4</i>	
Ambient air temperature, $T_o$	28 – 50 °C
Ambient air relative humidity, $RH_o$	18% → 84%
<i>Gas Turbine, Model HITACH-FS-7001B</i>	
Pressure ratio, $P_2/P_1$	10
Net power, ISO	52.4 MW
Site power	37 MW
Turbine inlet temperature $T_3$	1273.15 K
Volumetric air flow rate	250 m <sup>3</sup> s <sup>-1</sup> at NPT
Fuel net calorific value, $NCV$	46000 kJ kg <sup>-1</sup>
Turbine efficiency, $\eta_t$	0.88
Air Compressor efficiency $\eta_c$	0.82
Combustion efficiency $\eta_{comb}$	0.85
<i>Generator</i>	
Electrical efficiency	95%
Mechanical efficiency	90%
<i>Water Chiller</i>	
Refrigerant	R22
Evaporating temperature, $T_e$	$T_{chws} - TD_e$ °C
Superheat	10 K
Condensing temperature, $T_c$	$T_o + TD_c$ K
Condenser design temperature difference $TD_c$	10 K
Evaporator design temperature difference $TDe$	6 K
Subcooling	3 K
Chilled water supply temperature, $T_{chws}$	5 °C
Chiller evaporator effectiveness, $\epsilon_{eff,er}$	85%
Chiller compressor energy use efficiency, $\eta_{eu}$	85%
$\alpha_{ch}$	172 \$/kW
<i>Cooling Coil</i>	
Cooling coil effectiveness $\epsilon_{eff,cc}$	85%
Contact Factor, CF	50%
<i>Economics analysis</i>	
Interest rate $i$	10%
Period of repayment (Payback period), $n$	3 years
The maintenance cost, $\alpha_m$	10% of $C_{ch}^c$
Electricity rate, $C_{el}$ (Eqs. 33&34)	0.07 \$/kWh
Cost of selling excess electricity, $C_{els}$ (Eqs. 40&41)	0.07-0.15 \$/kWh
Hours of operation per year, $t_{op}$	7240 h/y

Table 2. Range of parameters for the present analysis

Hour	$T_o$ °C	$RH_o$	$T_1$ °C	$RH_1$	Hour	$T_o$ °C	$RH_o$	$T_1$ °C	$RH_1$
0	33.4	0.38	19.2	0.64	12	44.0	0.33	24.5	0.64
1	32.6	0.44	18.8	0.70	13	45.2	0.34	25.1	0.66
2	31.7	0.8	18.35	0.99	14	50.0	0.18	27.5	0.43
3	30.5	0.77	17.75	0.98	15	47.0	0.25	26.0	0.53
4	29.0	0.76	17.0	0.99	16	45.9	0.30	25.45	0.61
5	28.5	0.84	16.75	0.97	17	43.0	0.37	24.0	0.69
6	30.0	0.83	17.5	0.99	18	43.0	0.24	24.0	0.50
7	32.2	0.79	18.6	0.96	19	37.9	0.45	21.45	0.76
8	35.1	0.67	20.05	0.99	20	37.4	0.40	21.2	0.69
9	38.0	0.51	21.5	0.84	21	37.6	0.33	21.3	0.60
10	40.2	0.35	22.6	0.64	22	37.1	0.34	21.05	0.61
11	43.3	0.37	24.15	0.69	23	36.8	0.32	20.90	0.58

Table 3. The ambient conditions and the cooling coil outlet temperature and humidity during 18<sup>th</sup> August 2008 operation

Solution of Equations 50 and 51, using the data in Table 3, gives the daily variation in *PGR* and *TEC*, Figure 7. There is certainly a potential benefit of adding the cooling system where there is an increase in the power output all the time, the calculated average for the design day is 12.25 %. The *PGR* follows the same pattern of the ambient temperature; the increase in power of the GT plant reaches a maximum of 15.46 %, with a little change in the plant thermal efficiency. The practical illustrative application indicates that a maximum decrease in the thermal efficiency change of only 0.391 % occurs at 13:00 PM when the air temperature is 45.2°C, and 34% RH.

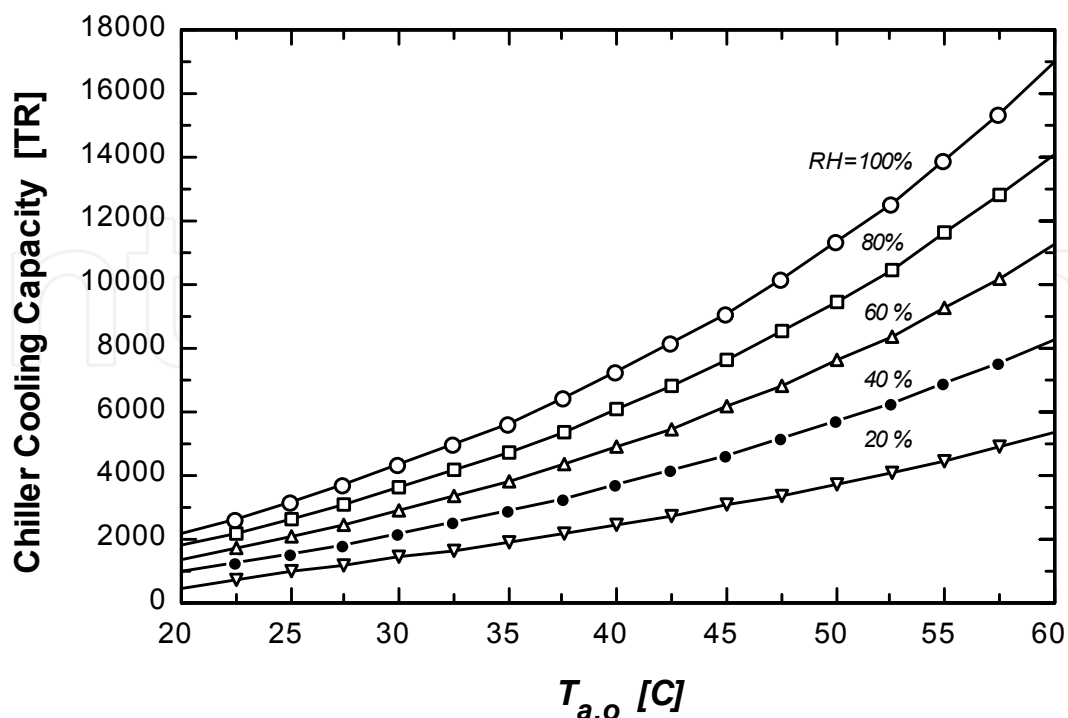

Fig. 5. Dependence of chiller cooling capacity on the climatic conditions

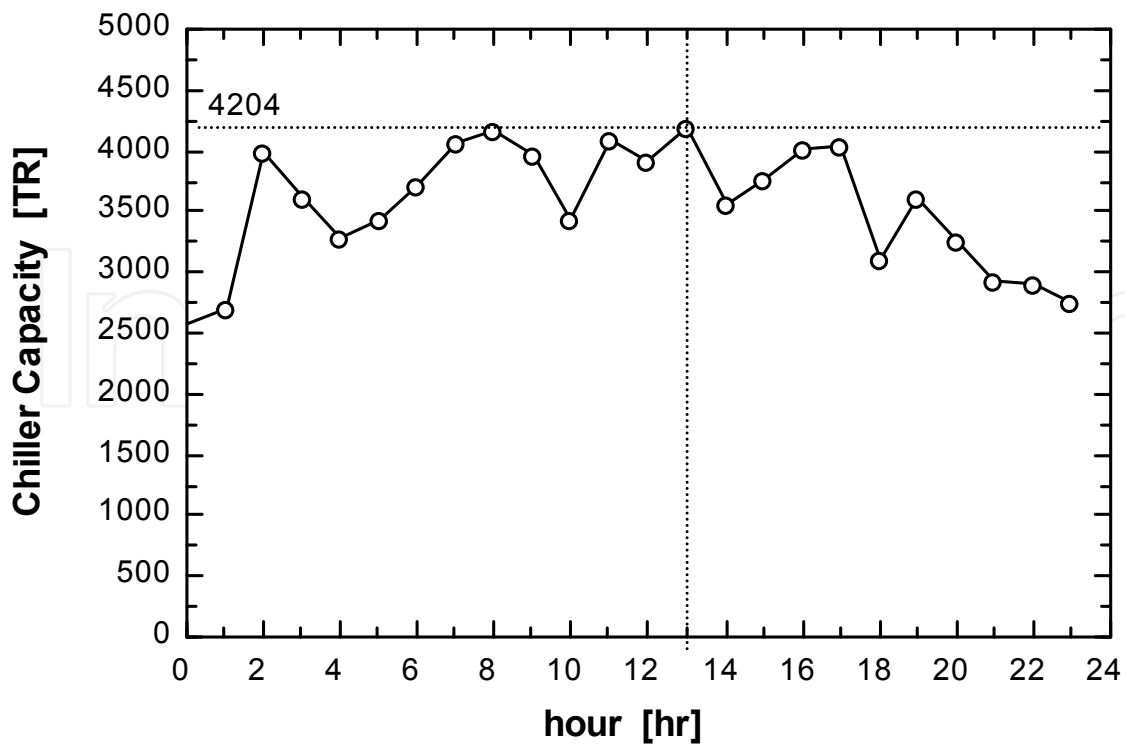

Fig. 6. Chiller capacity variation with the climatic conditions of the selected design day

On basis of the second law analysis the exergetic power gain ratio  $PGR_{ex}$  is still positive meaning that there is increase in output power but at a reduced value than that of the energy analysis.

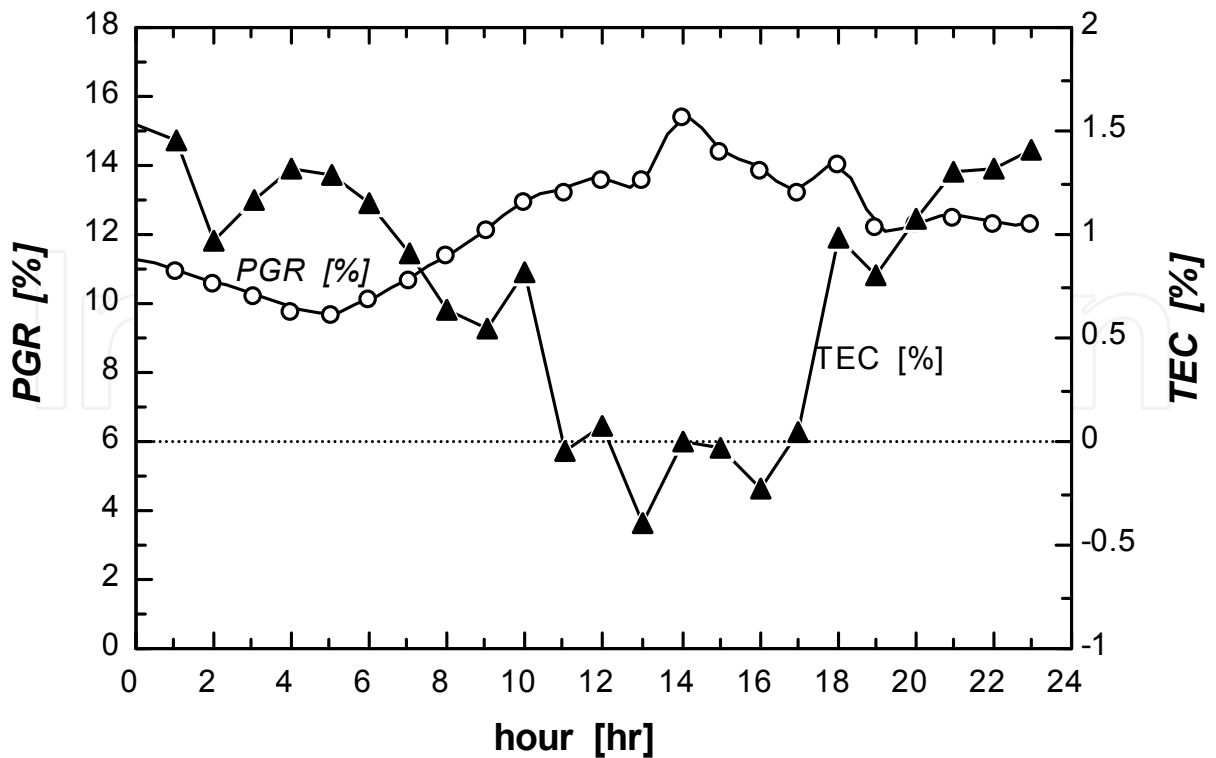

Fig. 7. Variation of gas turbine PGR and TEC during 18<sup>th</sup> August operation

Figure 8. shows that the power increase for the worst day of the year that varies between 7% to 10.4% (average 8.5%) and the thermal efficiency drops by a maximum of 6%. These result indicate the importance of the second law analysis.

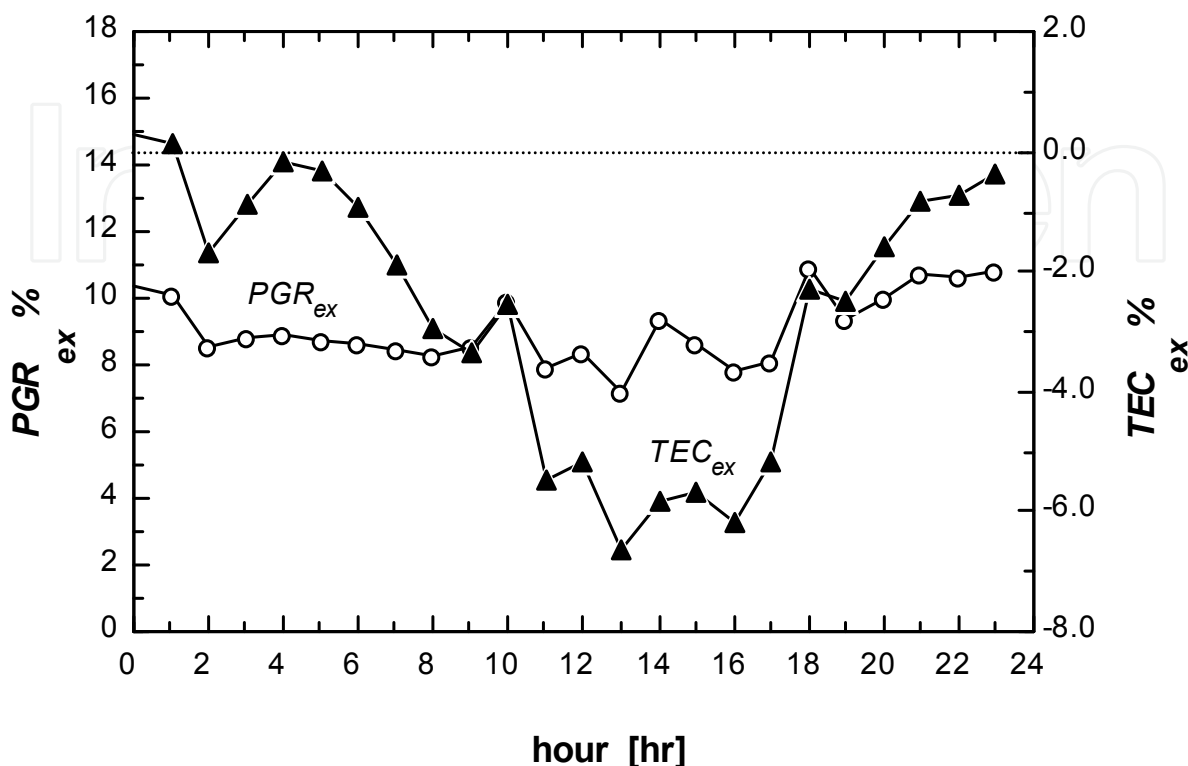

Fig. 8. Variation of gas turbine exergetic  $PGR_{ex}$  and  $TEC_{ex}$  during 18<sup>th</sup> August operation

Based on the daily variation of the ambient conditions on August 18<sup>th</sup>, assuming different values for selling the electricity ( $C_{els}$ ), Eq. 59 gives the hourly revenues needed to payback the investment after a specified operation period (selected by 3 years). The different terms in Equations 49 and 59 are calculated and presented in Figure 9. The effect of the climate changes is quite obvious on both the total expenses (Fig. 9) and the GT net power output (Fig. 7). The variations in  $C_{total}$  are due to the changes in  $\dot{Q}_{cv}$  in Eq. 49 that depends on ( $T_o, T_1, \omega_o$  and  $\omega_1$ ). The revenue from selling additional electricity is also presented in the same figure, which shows clearly the potential of adding the cooling system. Figure 9 indicates that selling the electricity to the consumers at the same base price ( $C_{els} = C_{el} = 0.07$  \$/kWh) makes the cooling system barely profitable. The profit increases directly with the cost of selling the electricity. This result is interesting and encourages the utilities to consider a time-of-use tariff during the high demand periods. The profitability of the system, being the difference between the revenues and the total cost, is appreciable when the selling rate of the excess electricity generation is higher than the base rate of 0.07 \$/kWh.

Economy calculations for one year with 7240 operation hours and for different electricity selling rates are summarized in Table 4. The values show that there is always a net positive profit starting after the payback period for different energy selling prices. During the first 3 years of the cooling system life, there is a net profit when the electricity selling rate increases to 0.15 \$/kWh, nearly double the base tariff.

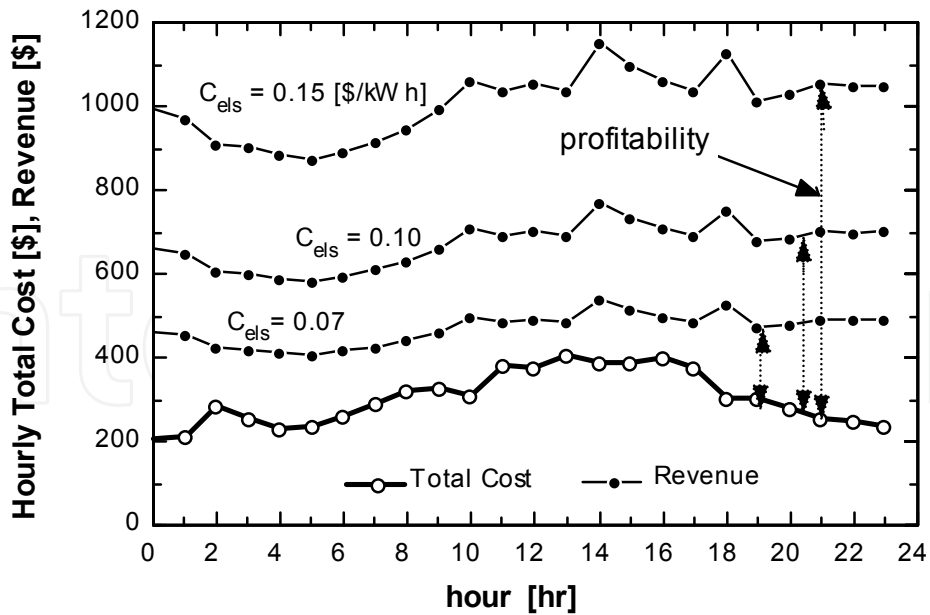

Fig. 9. Variation of hourly total cost and excess revenue at different electricity selling rate

Electricity selling rate $C_{els}$	Annuity-for Chiller, coil and maintenance	Annual operating cost	Annual net profit for the first 3 years	Annual net profit for the fourth year
\$/kWh	\$/y	\$/y	\$/y	\$/y
0.07	1,154,780	1,835,038	-1,013,600	+141180
0.1	1,154,780	1,835,038	-166,821	+ 987,962
0.15	1,154,780	1,835,038	1,244,978	+ 2,399,758

Table 4. Annual net profits out of retrofitting a cooling system to a GT, HITACHI FS-7001B at Yanbu for different product tariff and 3 years payback period

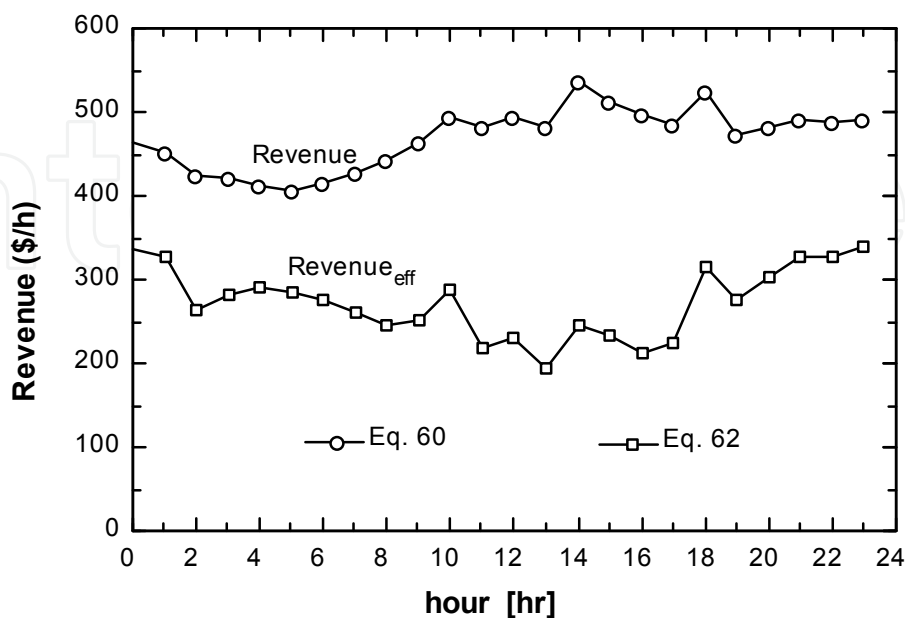

Fig. 10. Effect of irreversibility on the revenue,  $C_{els} = 0.07$  \$/kWh

Figure 10 shows the effect of irreversibilities on the economic feasibility of using an air cooling system for the selected case. The effective revenue Eq. 61 ( $Revenue_{eff}$ ) that can be accumulated from selling the net power output is reduced by 41.8% as a result of irreversibilities. The major contribution comes from the water chiller, where the irreversibility is the highest.

## 7. Conclusions

There are various methods to improve the performance of gas turbine power plants operating under hot ambient temperatures far from the ISO standards. One proven approach is to reduce the compressor intake temperature by installing an external cooling system. In this paper, a simulation model that consists of thermal analysis of a GT and coupled to a refrigeration cooler, exergy analysis and economics evaluation is developed. The performed analysis is based on coupling the thermodynamics parameters of the GT and cooler unit with the other variables as the interest rate, life time, increased revenue and profitability in a single cost function. The augmentation of the GT plant performance is characterized using the power gain ratio (PGR) and the thermal efficiency change term (TEC).

The developed model is applied to a GT power plant (HITACHI FS-7001B) in the city of Yanbu (20° 05' N latitude and 38° E longitude) KSA, where the maximum DBT has reached 50°C on August 18<sup>th</sup>, 2008. The recorded climate conditions on that day are selected for sizing out the chiller and cooling coil capacities. The performance analysis of the GT shows that the intake air temperature decreases by 12 to 22 K, while the PGR increases to a maximum of 15.46%. The average increase in the plant power output power is 12.25%, with insignificant change in plant thermal efficiency. The second law analysis shows that the exergetic power gain ratio drops to an average of 8.5% with 6% maximum decrease in thermal efficiency.

In the present study, the profitability resulting from cooling the intake air is calculated for electricity rates between 0.07 and 0.15 \$/kWh and a payback period of 3 years. Cash flow analysis of the GT power plant in the city of Yanbu shows a potential for increasing the output power of the plant and increased revenues.

## 8. Nomenclatures

$A_{cc}$	Cooling coil heat transfer area, m <sup>2</sup>
$C_{cc}^c$	capital cost of cooling coil (\$)
$C_{ch}^c$	capital cost of chiller (\$)
$C_{el}$	unit cost of electricity, \$/kWh
$c_p$	specific heat of gases, kJ/kg K
$CF$	contact factor
$E$	energy kWh
$EES$	engineering Equation Solver
$h_v$	specific enthalpy of water vapor in the air, kJ/kg
$i$	interest rate on capital



$\dot{i}$	exergy destruction, kW
$k$	specific heats ratio.
$\dot{m}$	mass flow rate, kg s <sup>-1</sup>
$\dot{m}_a$	air mass flow rate, kg/s
$\dot{m}_{cw}$	chilled water mass flow rate, kg/s
$\dot{m}_r$	refrigerant mass flow rate, kg/s
$\dot{m}_w$	condensate water rate, kg/s
NCV	net calorific value, kJ kg <sup>-1</sup>
$P$	pressure, kPa
PGR	power gain ratio
$P_o$	atmospheric pressure, kPa
PR	pressure ratio = $P_2/P_1$
$\dot{Q}_h$	heat rate, kW
$\dot{Q}_{e,r}$	chiller evaporator cooling capacity, kW
$\dot{Q}_{cc}$	cooling coil thermal capacity, kW
$\dot{S}$	entropy, kJ/K
$t$	time, s
$T$	Temperature, K
TEC	thermal efficiency change factor
$U$	overall heat transfer coefficient, kW/m <sup>2</sup> K
$x$	quality.
$\dot{W}$	power, kW

#### Greek symbols

$\eta$	efficiency
$\varepsilon_{eff}$	effectiveness, according to subscripts
$\omega$	specific humidity (also, humidity ratio), according to subscripts, kg/kg <sub>dry air</sub>

#### Subscripts

$a$	dry air
$c$	with cooling
$cc$	cooling coil
$ch$	chiller
$comb$	combustion
$comp$	compressor
$eff$	effective
$el$	electricity
$f$	fuel
$g$	gas
$nc$	no cooling
$o$	ambient
$t$	turbine
$v$	vapor

## 9. References

- Alhazmy MM, Jassim RK, Zaki GM. 2006. Performance enhancement of gas turbines by inlet air-cooling in hot and humid climates. *International Journal of Energy Research* 30:777-797
- Alhazmy MM. and Najjar YS. 2004. Augmentation of gas turbine performance using air coolers, *App. Thermal Engineering*. 24: 415-429.
- Ameri M, Nabati H. Keshtgar A. 2004. Gas turbine power augmentation using fog inlet cooling system. *Proceedings ESDA04 7<sup>th</sup> Biennial conf. engineering systems design and analysis*, Manchester UK. paper ESDA 2004-58101.
- Ameri M, Shahbazian HR, Nabizadeh M. 2007. Comparison of evaporative inlet air cooling systems to enhance the gas turbine generated power. *Int. J. Energy Res.* 31: 483-503
- Chaker M, Meher-Homji CB, Mee III, Nicholson A. 2003. Inlet fogging of gas turbine engines detailed climatic analysis of gas turbine evaporation cooling potential in the USA. *J Eng Gas Turbine Power* 125(1):300-309.
- Chaker M., Meher-Homji, CB, Mee M. 2002. Inlet fogging of gas turbine engines - Part B: Fog droplet sizing analysis, nozzle types, measurement and testing, *ASME Proceedings of Turbo Expo 2002*, 4:429-442.
- Chaker, M, Meher-Homji CB, Mee M. 2002. Inlet fogging of gas turbine engines - part c: fog behavior in inlet ducts, cfd analysis and wind tunnel experiments, *ASME Proceedings of Turbo Expo 2002*, Vol. 4:443-455.
- Cleland AJ, Cleland DJ, White SD. 2000. *Cost-Effective Refrigeration*, Short course notes, Institute of Technology and Engineering, Massey University, New Zealand
- Cortes CPE, Williams D. 2003. Gas turbine inlet cooling techniques: An overview of current technology. *Proceedings Power GEN 2003*, Las Vegas Nevada Dec. 9-11.
- Dossat RJ. 1997. *Principles of Refrigeration*, John Wiley and Sons, NY.
- Elliot J. 2001. Chilled air takes weather out of equation, *Diesel and gas turbine world wide*, Oct: 49-96.
- Erickson DC. 2003. Aqua absorption turbine inlet cooling, *Proceedings of IMEC 03, ASME International Mechanical Engineering Congress & Exposition*, Nov. 16-21, Washington DC
- Erickson DC. 2005. Power fogger cycle. *ASHRAE Transactions* 111, part 2:551-554.
- Farzaneh-Gord M and Deymi-Dashtebayaz M. 2009. A new approach for enhancing performance of a gas turbine (case study: Khangiran refinery). *Applied Energy* 86: 2750-2759
- Gajjar H, Chaker M. 2003. Inlet fogging for a 655 MW combined cycle power plant-design, implementation and operating experience, *ASME Proceedings of Turbo Expo 2003*, Vol. 2:853-860.
- Gareta R, Romeo LM, Gil A. 2004. Methodology for the economic evaluation of gas turbine air cooling systems in combined cycle applications *Energy* 29:1805-1818.
- Hameed Z, Personal communication, Salim York Co. Saudi Arabia
- Hasnain SM, Alawaji SH, Al-Ibrahim AM, Smiai MS. 2000. Prospects of cool thermal storage utilization in Saudi Arabia. *Energy Conversion & Management* 41: 1829-1839.
- Homji-Meher, BC, Mee T, Thomas R. 2002. Inlet fogging of gas turbine engines, part B: Droplet sizing analysis nozzle types, measurement and testing, *Proceedings of the ASME Turbo Expo 2002*, Amsterdam, Netherlands, June 2002 paper No: GT-30563.

- Jassim RK, Zaki GM, Alhazmy MM. 2009, Energy and Exergy Analysis of Reverse Brayton Refrigerator for Gas Turbine Power Boosting, *Int. Journal of Exergy* 6 (2): 143-165.
- Jassim, RK, Khir T, Habeebullah BA and Zaki, GM. 2005. Exergoeconomic Optimization of the Geometry of Continuous Fins on an Array of Tubes of a Refrigeration Air Cooled Condenser, *Int. Journal of Exergy*. 2 (2): 146-171.
- Jonsson M, Yan J. 2005. Humidified gas turbines- A review of proposed and implemented cycles, *Energy* 30: 1013-1078.
- Kakarus E, Doukelis A, Karellas S. 2004. Compressor intake air cooling in gas turbine plants. *Energy* 29:2347-2358.
- Khan JR, Lear WE, Sherif SA, Crittenden JF. 2008. Performance of a novel combined cooling and power gas turbine with water harvesting. *ASME Journal of Engineering for Gas Turbines and Power* 130 (4).
- Khir T, Jassim RK, Zaki, GM. 2007. Application of Exergoeconomic Techniques to the optimization of a refrigeration evaporator coil with continuous fins. *Trans, ASME, Journal of Energy Resources Technology* 129 (3): 266-277.
- Klein KA, Alvarado FL. 2004. EES-Engineering Equation Solver, Version 6.648 ND, F-Chart Software, Middleton, WI.
- Kotas TJ. 1995. *The exergy method of thermal plant analysis*, Krieger, Malabar, Florida, USA.
- McQuiston FC, Parker JD, Spiliter JD. 2005. Heating, Ventilating and Air conditioning: Design and analysis, 6<sup>th</sup> edition, John Wiley, NY.
- Ondrays IS, Wilson DA, Kawamoto N, Haub GL. 1991. Options in gas turbine power augmentation using inlet air chilling. *Eng. Gas Turbine and Power*. 113: 203-211.
- Punwani D, Pierson T, Sanchez C, Ryan W. 1999. Combustion turbine inlet air cooling using absorption chillers some technical and economical analysis and case summaries *ASHRAE Annual Meeting, Seattle, Washington, June, 99*.
- Sanaye S, Tahani M. 2010. Analysis of gas turbine operating parameters with inlet fogging and wet compression processes, *Applied thermal engineering*, 30: 234-244.
- Stewart W, Patrick A. 2000. Air temperature depression and potential icing at the inlet of stationary combustion turbines. *ASHRAE Transactions* 106, pt 2:318-327.
- Tillman TC, Blacklund DW, Penton JD. 2005. Analyzing the potential for condensate carry-over from a gas cooling turbine inlet cooling coil, *ASHRAE Transactions* 111 (Part 2) DE-05-6-3: 555-563.
- Wang T, Li X and Pinniti V. 2009. Simulation of mist transport for gas turbine inlet air-cooling. *ASME Int. Mec. Eng congress*, November 13-19. Anaheim, Ca, USA,
- Yang C, Yang Z, Cai R. 2009. Analytical method for evaluation of gas turbine inlet air cooling in combined cycle power plant, *Applied Energy* 86:848-856
- Zaki GM, Jassim RK, Alhazmy MM. 2007. Brayton refrigeration Cycle for gas turbine inlet air cooling, *International Journal of Energy Research* 31:1292-1306.

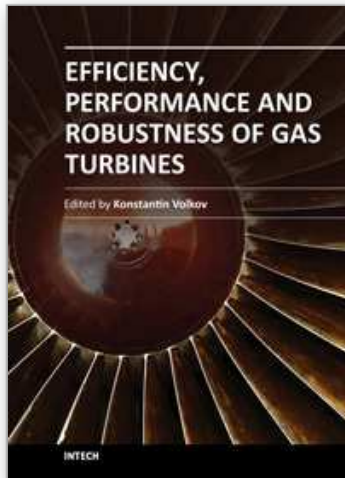

## **Efficiency, Performance and Robustness of Gas Turbines**

Edited by Dr. Volkov Konstantin

ISBN 978-953-51-0464-3

Hard cover, 238 pages

**Publisher** InTech

**Published online** 04, April, 2012

**Published in print edition** April, 2012

A wide range of issues related to analysis of gas turbines and their engineering applications are considered in the book. Analytical and experimental methods are employed to identify failures and quantify operating conditions and efficiency of gas turbines. Gas turbine engine defect diagnostic and condition monitoring systems, operating conditions of open gas turbines, reduction of jet mixing noise, recovery of exhaust heat from gas turbines, appropriate materials and coatings, ultra micro gas turbines and applications of gas turbines are discussed. The open exchange of scientific results and ideas will hopefully lead to improved reliability of gas turbines.

### **How to reference**

In order to correctly reference this scholarly work, feel free to copy and paste the following:

Rahim K. Jassim, Majed M. Alhazmy and Galal M. Zaki (2012). Energy, Exergy and Thermoconomics Analysis of Water Chiller Cooler for Gas Turbines Intake Air Cooling, Efficiency, Performance and Robustness of Gas Turbines, Dr. Volkov Konstantin (Ed.), ISBN: 978-953-51-0464-3, InTech, Available from: <http://www.intechopen.com/books/efficiency-performance-and-robustness-of-gas-turbines/energy-exergy-and-thermoconomics-analysis-of-water-chiller-cooler-for-gas-turbines-intake-air-cooli>

**INTECH**  
open science | open minds

### **InTech Europe**

University Campus STeP Ri  
Slavka Krautzeka 83/A  
51000 Rijeka, Croatia  
Phone: +385 (51) 770 447  
Fax: +385 (51) 686 166  
[www.intechopen.com](http://www.intechopen.com)

### **InTech China**

Unit 405, Office Block, Hotel Equatorial Shanghai  
No.65, Yan An Road (West), Shanghai, 200040, China  
中国上海市延安西路65号上海国际贵都大饭店办公楼405单元  
Phone: +86-21-62489820  
Fax: +86-21-62489821

© 2012 The Author(s). Licensee IntechOpen. This is an open access article distributed under the terms of the [Creative Commons Attribution 3.0 License](#), which permits unrestricted use, distribution, and reproduction in any medium, provided the original work is properly cited.

IntechOpen

IntechOpen