

We are IntechOpen, the world's leading publisher of Open Access books Built by scientists, for scientists

5,300

Open access books available

132,000

International authors and editors

160M

Downloads

Our authors are among the

154

Countries delivered to

TOP 1%

most cited scientists

12.2%

Contributors from top 500 universities



WEB OF SCIENCE™

Selection of our books indexed in the Book Citation Index
in Web of Science™ Core Collection (BKCI)

Interested in publishing with us?
Contact book.department@intechopen.com

Numbers displayed above are based on latest data collected.
For more information visit www.intechopen.com



Chemical Reactor Control

Azzouzi Messaouda¹ and Popescu Dumitru²

¹*Ziane Achour University of Djelfa*

²*Politehnica University of Bucharest*

¹*Algeria*

²*Romania*

1. Introduction

The principal technological element of the industrial plants and the chemical reactions is the chemical reactor. In this chapter, it is considered that the chemical reactor is an apparatus in which the chemical process can be effectuated to obtain certain substances in technological process. The automatic control systems by their dynamic bring those processes to a point where the profile is optimal, a fact which imposes several methods to achieve the desired performances. This chapter proposes a hierarchical configuration of control which treats aspects related to the primary processing of data, processes identification, control and the robustness analysis under some conditions of the operating regime for representative plants in the chemical and petrochemical industry. It is a design of numerical control laws in a pyrolysis reactor in order to achieve an efficient regime of operation that allows as much as possible to optimize the concentration of produced ethylene by the chemical reactions (Popescu et al., 2006a; Landau & Zito, 2006).

2. Technologic overview of the plant

2.1 Technical description and operating conditions

The pyrolysis reactor as shown in figure (1) is planted in petrochemical plants and is intended to obtain ethylene, the combination of a quantity of gas with water under certain operative conditions can produce a chemical reaction, which has the ethylene as a result among the reaction products (Popescu et al., 2006b).

The block diagram shown in figure (1) describes the chemical transformations selected from a petrochemical plant whose pyrolysis took a large space. The kinetic parameters of reactions are determined by the mathematical adjustment to the experimental results obtained in several scientific resources in the combined model in the simplification of the oil and on its derivatives (Mellol, 2004).

2.2 Automation solutions of the reactor

Gas and steam are introduced to the plant of two access roads at a constant flow, but the amount of the necessary heat for the reaction is obtained from a heating system which uses

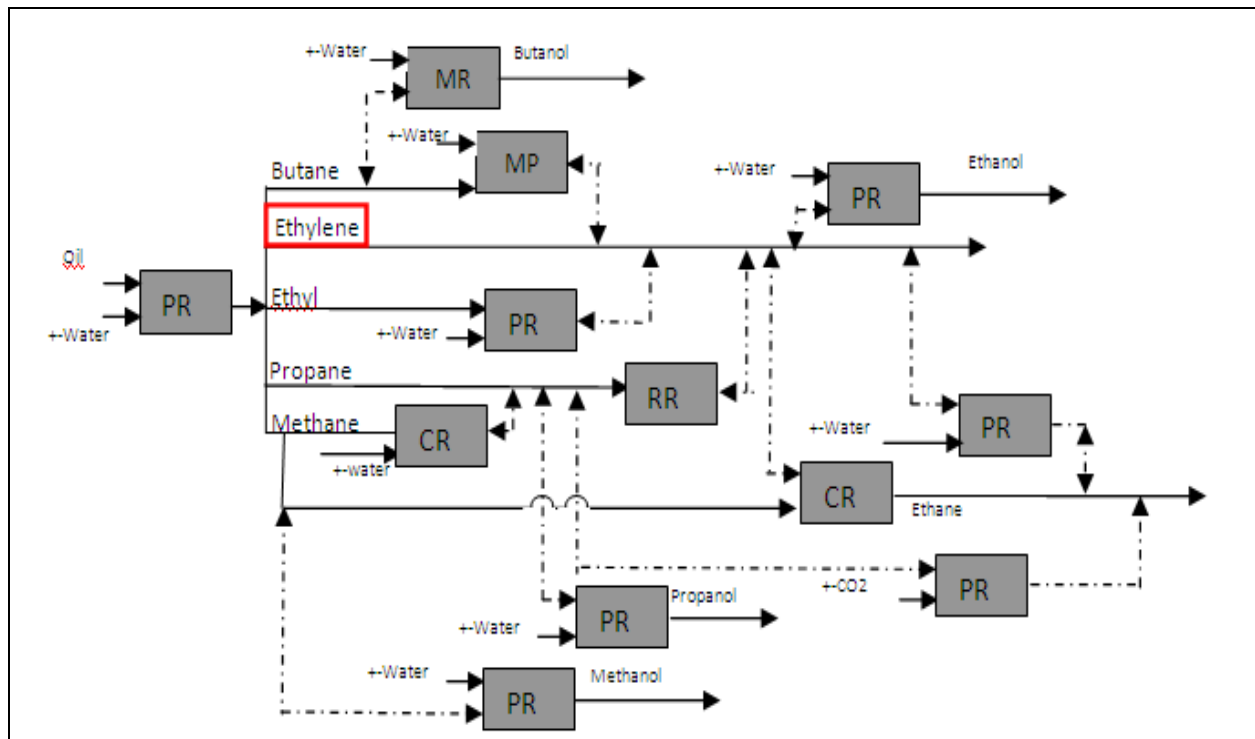

Fig. 1. Integration of Pyrolysis reactor into a petrochemical plant

Where

PR: pyrolysis reactor

MR: Membrane reactor

RR: Reforming reactor

CR: Catalytic reactor

a straight fuel powered methane gas (Harriott, 2002). For the insurance of the desired operation of the reactor, it is necessary to achieve an automation mechanism that provides a measurement system, automatic control and supervision of the parameters I/O, the automation solution is shown in figure (2), which there are implemented the four controllers:

Data were recorded using an acquisition card connected to a computer (Azzouzi, 2008). Variables are limited in technological point of view such as:

x1: flow of primary matter (oil) (1000 to 1600 Nm³/h)

x2: flow of steam (430-540 Nm³/h)

x3: working pressure (3.2-4.5 atm)

x4: working temperature (820-860°C)

y (%): the concentration of the useful product (ethylene) at the reactor output

2.2.1 Flow control

Automatic systems of flow control structure are made of simple adjustment depending on the error, such a structure is used only to maintain a flow to a specified value or as a secondary loop in a control structure that changes in cascade the flow with the level or concentration (Borne et al., 1993).

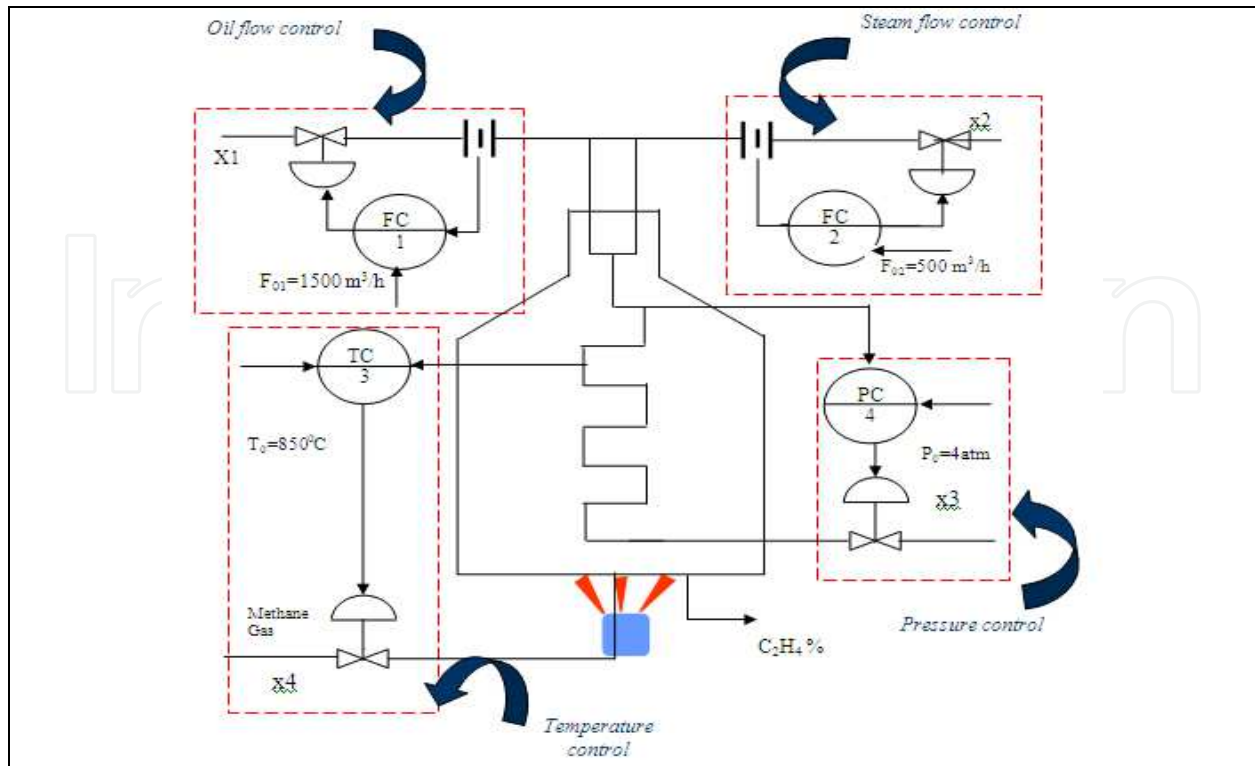

Fig. 2. Controller loops that govern the pyrolysis reactor.

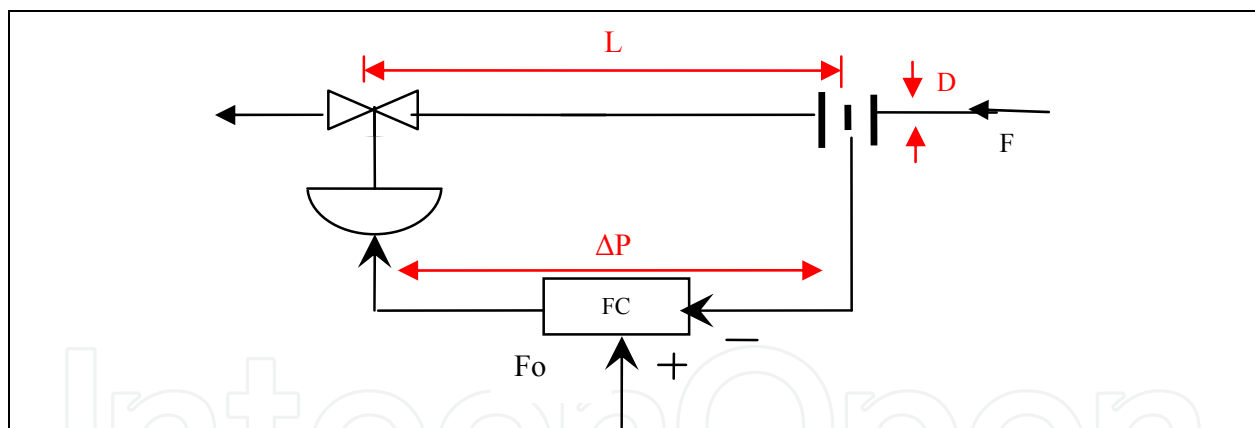

Fig. 3. Flow controller

Where:

R : radius of pipe

L : length de pipe

F : flow of fluid

F_0 : intial value of flow

ΔP : pressure reduction by restriction

α : flow coefficient

ρ : density of fluid

k_p : amplification factor, $k_p=0.5$

τ_{pa} : delay constant of channel, $\tau_{pa} = \chi^2 \frac{V_0}{F_0}$

V_0 : volume of fluid in the pipe in case of steady

M : mass of liquid through the pipe

v : flow rate of liquid through the pipe

For the flow control systems, using the theorem of short lines: pipeion is equivalent to a hydraulic resistance defined by the known relationship:

$$F = \alpha S \sqrt{\frac{2\Delta P}{\rho}} \quad (1)$$

For steady flow, the applied forces into the system are balanced, which implies:

$$\Delta P_0 - \frac{F_0^2 \rho}{2\alpha^2 S} = 0 \quad (2)$$

where:

ΔP_0 : is the active force to push the liquid in the pipe

$\frac{F_0^2 \rho}{2\alpha^2 S}$ is the reaction force by the restriction

In dynamic regime, the deference between these two forces is compensated by the rate of change of pulse time of the system.

$$\Delta P(t)S - \frac{F^2(t)\rho}{2\alpha^2 S} = \frac{d}{dt}(Mv) \quad (3)$$

Which imply that:

$$\Delta P(t)S - \frac{F^2(t)\rho}{2\alpha^2 S} = \rho L S \frac{1}{S} \frac{d}{dt}(F(t)) \quad (4)$$

Values are obtained that depend on t , if the variations of two arbitrary values of steady state are given as:

$$\begin{aligned} \Delta P(t) &= \Delta P_0 + \Delta(\Delta P(t)) = \Delta P_0 + \Delta p(t) \\ F(t) &= F_0 + \Delta F(t) \end{aligned} \quad (5)$$

From (4) and (5):

$$(\Delta P_0 + \Delta p(t))S - \frac{\rho(F_0 + \Delta F(t))^2}{2\alpha^2 S} = \rho L \frac{d}{dt}(F_0 + \Delta F(t)) \quad (6)$$

By extracting (6) and the steady state expressed by (2) and by ignoring the quadratic term $\Delta F^2(t)$, the following equation can be obtained:

$$\Delta p(t)S - \frac{2\rho F_0 \Delta F(t)}{2\alpha^2 S^2} S = \rho L \frac{d}{dt}(\Delta F(t)) \quad (7)$$

By the normativity in the steady state:

$$y(t) = \frac{\Delta F(t)}{F_0} \quad \text{and} \quad M(t) = \frac{\Delta p(t)}{\Delta P_0}$$

Which results lthe linear model with adimensional variables:

$$\alpha^2 \frac{V_0}{F_0} \frac{dy(t)}{dt} + y(t) = \frac{1}{2} m(t) \quad (8)$$

From equation (6), and by applying the Laplace transform, the transfer function of the execution channel can be got easily.

$$H_{pa}(s) = \frac{k_p}{\tau_{pa}s + 1} \quad (9)$$

Control of oil flow

The oil flow controller is shown in figure (4). In this study case of the pyrolysis reactor technology parameters are given by:

The length of the pipe $L = 10 \text{ m}$

The diameter of the pipe is 0.2m which means that $R = 0.1\text{m}$

The flow of rated speed; $F_{10} = 1500\text{m}^3/\text{h} = 0.41\text{m}^3/\text{sec}$

The flow coefficient $\alpha = 0.9$

The amplification factor $k_p = 0.9$

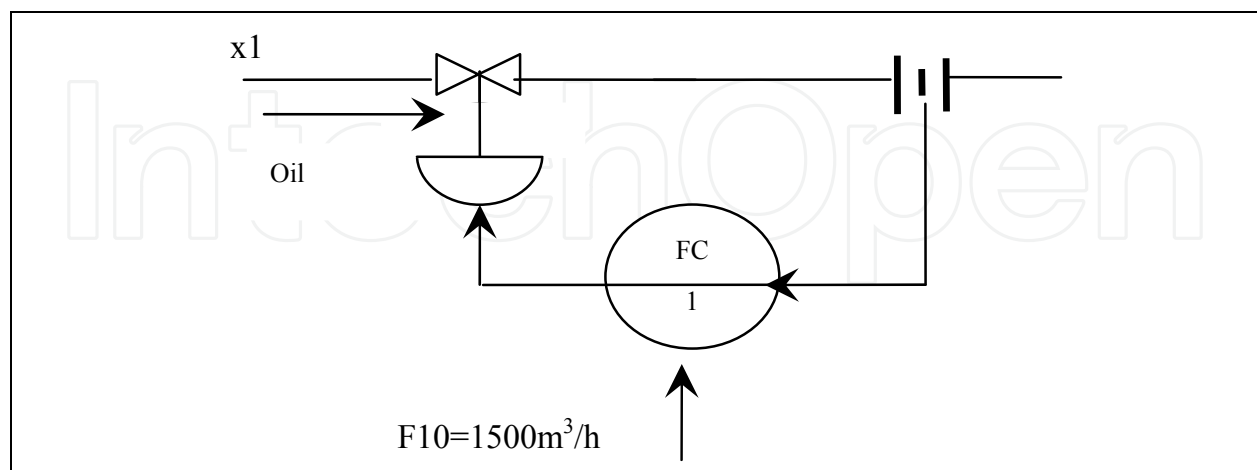

Fig. 4. Oil flow controller.

$$H_p(s) = \frac{0.5}{\alpha^2} \frac{V}{F_{10}s + 1} = \frac{0.5}{0.62s + 1} \quad (10)$$

$$V = \pi * r^2 * L = \pi \left(\frac{0.2}{2} \right)^2 * 10 = 3.14 * (0.01) * (10) = 0.314 \text{m}^3 \quad (11)$$

$$\alpha^2 \frac{V}{F_{10}} = 0.9^2 * \frac{0.314}{0.41} = 0.62 \quad (12)$$

$$H_E(s) = \frac{0.66}{8s + 1} \text{ transfer function of the actuator}$$

$$H_P(s) = \frac{0.5}{0.62s + 1} \text{ transfer function of the process}$$

$$H_T = \frac{\Delta I}{\Delta F_1} * \frac{F_{10}}{I_0} = \frac{16}{2000} * \frac{1500}{16} = 0.75 \text{ transfer function of the sensor}$$

$$\begin{aligned} H_F &= H_E * H_P * H_T = \frac{0.66}{8s + 1} * \frac{0.5}{0.62s + 1} * 0.75 \\ &= \frac{0.24}{(8s + 1)(0.62s + 1)} \end{aligned} \quad (13)$$

The parasite time constant 0.62 can be ignored because is too small compared to the main time constant 8s, so the controller has the following transfer function:

$$H_F(s) = \frac{0.24}{(8s + 1)} = \frac{K_p}{T_p s + 1} \quad (14)$$

It is recommended that a PI controller which has the form $H_R(s) = K_R \cdot \left(1 + \frac{1}{T_i s} \right)$

If $T_i = T_p = 8s$

$$H_d = H_R(s) \cdot H_F(s) = K_R \frac{(1 + T_i s)}{T_i s} \frac{K_p}{T_p s + 1} = \frac{K_R \cdot K_p}{T_p s} \quad (15)$$

$$H_0 = \frac{H_d}{H_d + 1} = \frac{K_R K_p / T_p s}{(K_R K_p / T_p s) + 1} = \frac{1}{\frac{T_p}{K_R K_p} s + 1} \quad (16)$$

$$\Rightarrow T_0 = \frac{T_p}{K_R \cdot K_p} = \frac{8}{0.24 K_R} \Rightarrow K_R = \frac{33.33}{T_0} \quad (17)$$

To set a time of 8s. It is necessary to choose, $T_0 = 2s \Rightarrow K_R \approx 16$ to facilitate the calculation.

$$H = 16 \cdot \frac{8s + 1}{8s} \cdot \frac{0.24}{(8s + 1)(0.62s + 1)} \quad (18)$$

MatLab is used to obtain graphs of the step response of this closed loop system. The transfer function of BF

$$HBF = \frac{30.72s + 3.84}{39.68s^3 + 68.96s^2 + 38.72s + 3.84} \quad (19)$$

From the above equation, the oil flow, the time response, the step response and the robustness diagrams can be plotted as shown in figure (5).

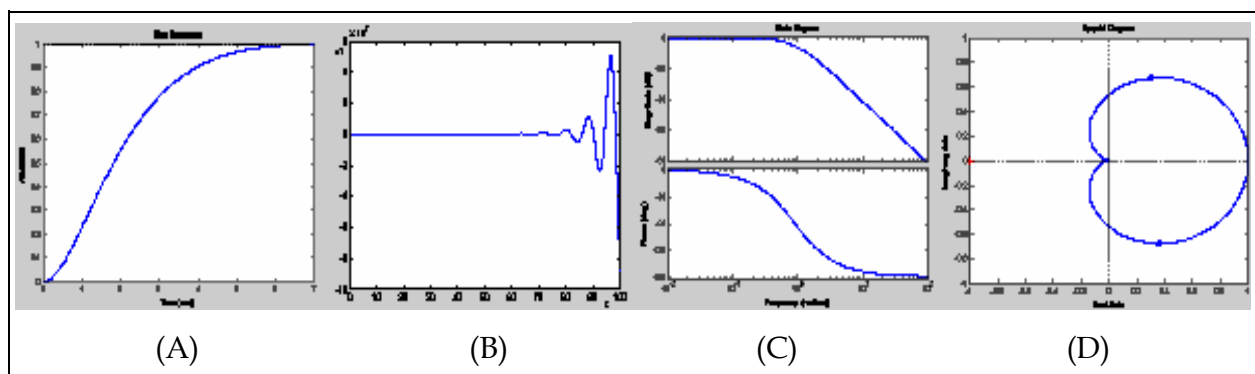

Fig. 5. (A) Step reponse, (B) Time response, (C) Bode diagram and (D) Nyquist diagram.

By the bilinear transformation $s = \frac{2}{T_p} \cdot \frac{1 - q^{-1}}{1 + q^{-1}}$, the deduced formula of the model and its

discrete PI controller is $H_{PI}(q^{-1}) = \frac{k_p}{2T_i} \left(\frac{(2T_i + T_p) + q^{-1}(T_p - 2T_i)}{2T_i(1 - q^{-1})} \right)$, which results:

Model

$$H(q^{-1}) = \frac{0.85q^{-2} + 1.4q^{-1} + 3.45}{q^{-2} + 2q^{-1} + 1} \quad (20)$$

Controller

$$R(q^{-1}) = 3 - q^{-1} \quad (21)$$

$$S(q^{-1}) = 2(1 - q^{-1}) \quad (22)$$

$$T(q^{-1}) = 2 \quad (23)$$

Steam flow control

The controller in case of steam flow is shown in figure (6). Such as the technological parameters which are given by:

The length of the pipe 5 m

The diameter of the pipe is 0.1m which means that $R = 0.05\text{m}$

The flow of nominal regime $F_{20}=500\text{m}^3/\text{h}=0.14\text{m}^3/\text{sec}$

Flow coefficient $\alpha = 0.95$

$$H_p(s) = \frac{0.5}{\alpha^2} \frac{1}{\alpha^2 V/F_{10} s + 1} = \frac{0.5}{0.16s + 1} \quad (24)$$

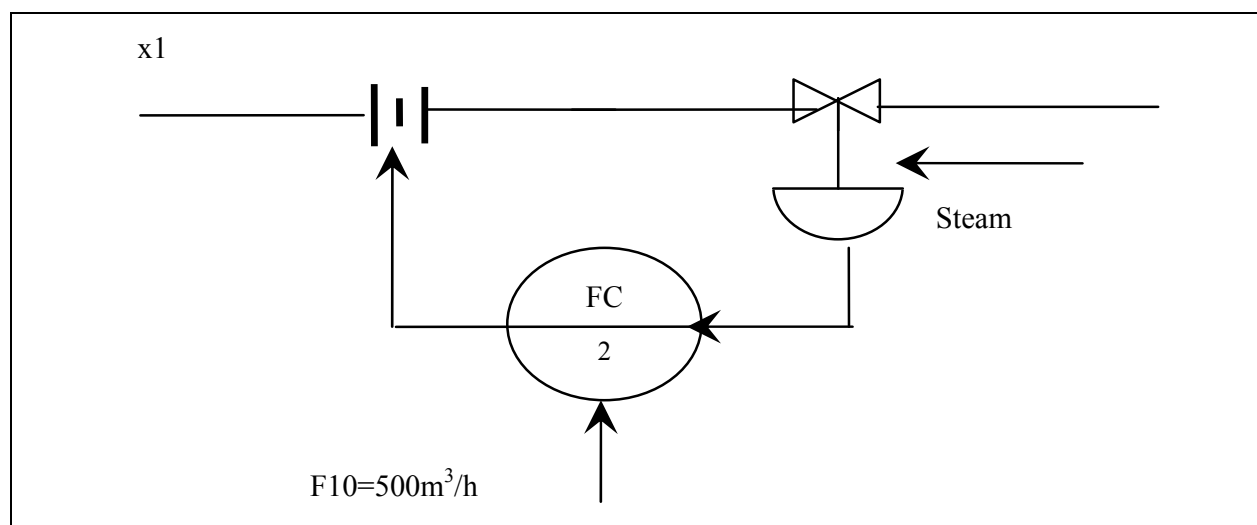

Fig. 6. Control of steam flow.

$$V = \pi * r^2 * L = \pi \left(\frac{0.1}{2} \right)^2 * 5 = 3.14 * (0.05)^2 * (5) = 0.4 \quad (25)$$

$$\alpha^2 \frac{V}{F_{20}} = 0.74^2 * \frac{0.4}{0.14} = 0.16 \quad (26)$$

$$H_E(s) = \frac{0.66}{4s + 1} \text{ transfer function of the actuator}$$

$$H_p(s) = \frac{0.5}{0.16s + 1} \text{ transfer function of the process}$$

$$H_T = \frac{\Delta I}{\Delta F_1} \cdot \frac{F_{10}}{I_0} = \frac{16}{2000} \cdot \frac{500}{12} = 0.66 \text{ transfer function of the sensor}$$

$$H_F = H_E \cdot H_p \cdot H_T = \frac{0.66}{4s + 1} \cdot \frac{0.5}{0.16s + 1} \cdot 0.66 = \frac{0.21}{(4s + 1)(0.16s + 1)} \quad (27)$$

The parasite time constant 0.16s because it is too small compared to the main time constant

4s, then the controller transfer function will be: $H_F(s) = \frac{0.21}{(4s+1)} = \frac{K_p}{T_p s + 1}$

It is recommended the use of PI controller $H_R(s) = K_R \cdot \left(1 + \frac{1}{T_i s}\right)$, when $T_i = T_p = 4s$

$$H_d = H_R(s) \cdot H_F(s) = K_R \frac{(1 + T_i s)}{T_i s} \frac{K_p}{T_p s + 1} = \frac{K_R \cdot K_p}{T_p s} \quad (28)$$

$$H_0 = \frac{H_d}{H_d + 1} = \frac{K_R K_p / T_p s}{(K_R K_p / T_p s) + 1} = \frac{1}{\frac{T_p}{K_R K_p} s + 1} \quad (29)$$

$$\Rightarrow T_0 = \frac{T_p}{K_R \cdot K_p} = \frac{4}{0.21 K_R} \Rightarrow K_R = \frac{19}{T_0} \quad (30)$$

To specify a transient time of 8s, it is necessary to choose

$$T_0 = 2s \Rightarrow K_R \approx 9 \Rightarrow H_R(s) = 9 \left(1 + \frac{1}{8s}\right)$$

The use of MatLab to check the robustness of the closed loop system gives:
The transfer function:

$$HBF = \frac{0.21}{0.84s^2 + 4.16s + 1.21} \quad (31)$$

The time response with the step response and Nyquist and Bode plots are respectively represented in figure (7).

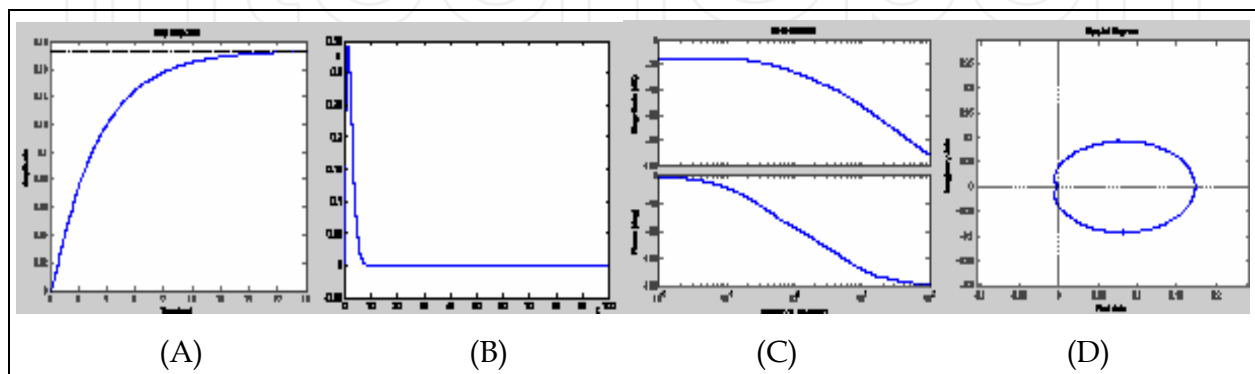

Fig. 7. (A) Step reponse, (B) Time response, (C) Bode diagram and (D) Nyquist diagram.

After the bilinear transformation $s = \frac{2}{T_p} \cdot \frac{1-q^{-1}}{1+q^{-1}}$, so the discrete formula of the controller is

$$\text{PI } H_{\text{PI}}(q^{-1}) = \frac{k_p}{2T_i} \left(\frac{(2T_i + T_p) + q^{-1}(T_p - 2T_i)}{2T_i(1 - q^{-1})} \right) \text{ which results:}$$

Model

$$H(q^{-1}) = \frac{-0.92q^{-2} + 1.68q^{-1} + 3.24}{q^{-2} + 2q^{-1} + 1} \quad (32)$$

Controller

$$R(q^{-1}) = 9(3 - q^{-1}) \quad (33)$$

$$S(q^{-1}) = 16(1 - q^{-1}) \quad (34)$$

$$T(q^{-1}) = 18 \quad (35)$$

2.2.2 Control of the reaction pressure

In systems of pressure control, It is determined for example, a mathematical model for a pneumatic capacity powered by a fluid (gas phase), the structure of a pressure control system, is given in figure (8) (Bozga & Muntean, 2000).

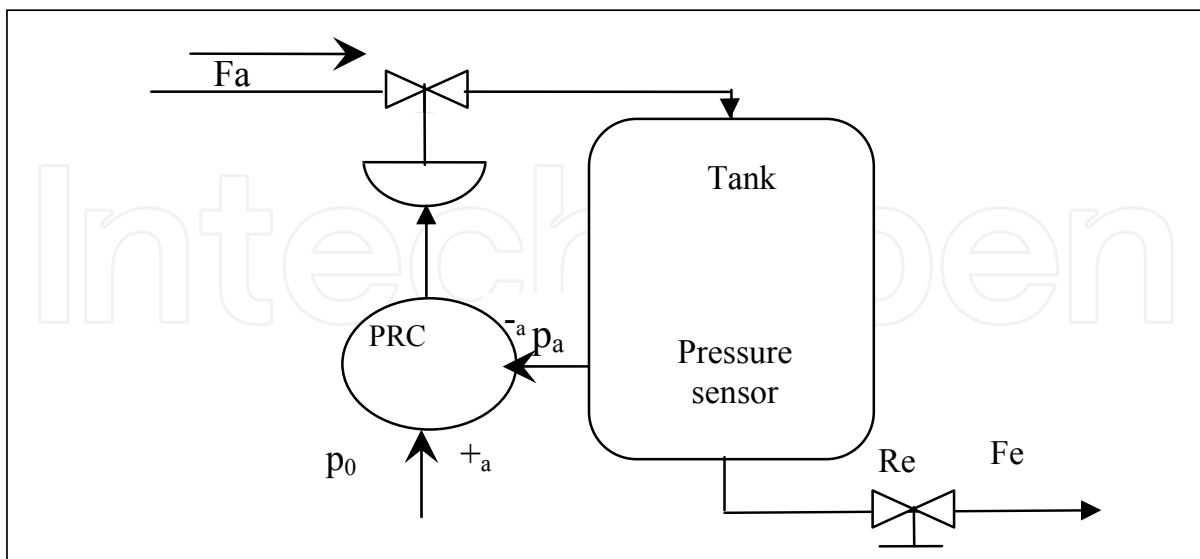

Fig. 8. Pressure control

Where

R: universal gas constant;

F: feed rate;

Fe extraction rate;

p: pressure;

p0: required value for the pressure.

After filtering data recorded previously, and estimated degrees of polynomials by the software WinPim (Azzouzi, 2009b). It was found that the polynomial A is of the second degree, while the polynomial B is of the first degree, the validation test has confirmed the quality of the chosen model, the results of the identification and regulation respectively by using WinPim and WinReg are:

Model

Structure of model of identification system: ARX

Identification method: recursive least squares

Adaptation algorithm parametric decreasing gain

Te=3s

Delay: D=0

$$H(q^{-1}) = \frac{B(q^{-1})}{A(q^{-1})} = \frac{0.0471q^{-1}}{1 - 1.614q^{-1} + 0.653q^{-2}} \quad (36)$$

Controller

Method : poles placement

$$R(q^{-1}) = 43.173 - 45.371q^{-1} + 13.87q^{-2} \quad (37)$$

$$S(q^{-1}) = 1 - q^{-1} \quad (38)$$

$$T(q^{-1}) = 21.227 - 12.35q^{-1} + 2.76q^{-2} \quad (39)$$

Reference model

$$Am(q^{-1}) = 1 - 0.697q^{-1} + 0.151q^{-2} \quad (40)$$

$$Bm(q^{-1}) = 0.297 + 0.157q^{-1} \quad (41)$$

To maximize the natural frequency and the damping factor, it should be considered initially that in tracking $w_0=0.35$ rad/s and $\xi=0.9$ then for the regulation $w_0=0.4$ rad/s and $\xi=0.85$. Figure (9) shows the Nyquist diagram with the shift of the poles from a proposed system P1 to a robust P4 after the change of the tracking and control polynomials.

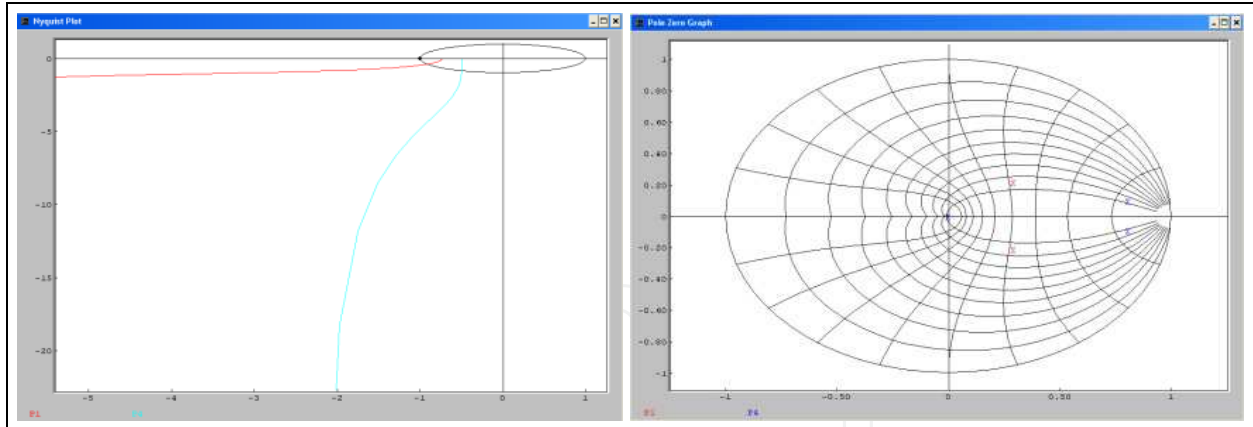

Fig. 9. Nyquist diagram and poles in closed loop.

Robustness margins are respectively shown in table (1), the goal here is to approach the margins from known robustness margins. A slow change in parameter values and further regulation and tracking may increase the system robustness in closed loop (Oustaloup, 1994).

Nr	Tracking		Regulation		ΔG (dB)	$\Delta\Phi$ (°)	$\Delta\tau$ (s)	ΔM (dB)
	Double		Double					
	w_0	ξ	w_0	ξ				
1	0.35	0.9	0.4	0.85	2.64	22.8	0.69	11.64
2	0.1	0.65	0.2	0.5	4.94	41.4	1.84	-7.25
3	0.08	0.7	0.1	0.6	6.16	61.0	3.23	-5.88
4	0.075	0.88	0.08	0.87	6.03	59.9	3.02	-6.01

Table 1. Robustness margins in function of tracking and control parameters.

The robustness test is important to identify the operating factors which are not necessarily considered in the development phase of the method, but could influence the results, and therefore to anticipate problems that may occur during the application of the chosen method. A series of curves to the robust sensitivity function analyzed by using WinReg is shown in figure (10). The new polynomials of the controller and the reference model are given as follows:

Controller

$$R(q^{-1}) = 21.274 - 34.150q^{-1} + 13.87q^{-2} \quad (42)$$

$$S(q^{-1}) = 1 - q^{-1} \quad (43)$$

$$T(q^{-1}) = 21.227 - 34.213q^{-1} + 13.98q^{-2} \quad (44)$$

Reference model

$$Am(q^{-1}) = 1 - 1.631q^{-1} + 0.673q^{-2} \quad (45)$$

$$Bm(q^{-1}) = 0.022 + 0.019q^{-1} \quad (46)$$

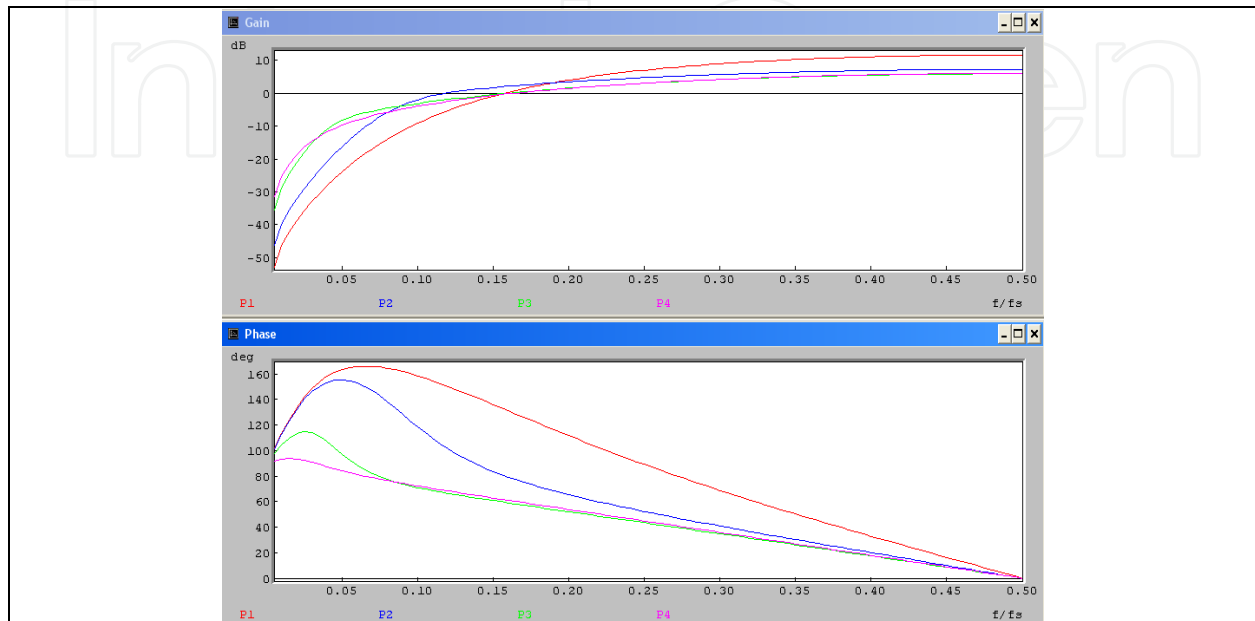

Fig. 10. Sensitivity function for the system robustification.

The introduction of an input signal step type in closed-loop system, with a delay of 10s and an amplitude of 1%, by adding a perturbation amplitude of $3.5 \cdot 10^{-3}\%$ applied at time 40s, results in a small attenuation of response at the same time of its application. Figure (11), shows the step response and the effect of disturbance on this response, which demonstrates that the tracking and control performances are provided (Azzouzi & Popescu, 2008).

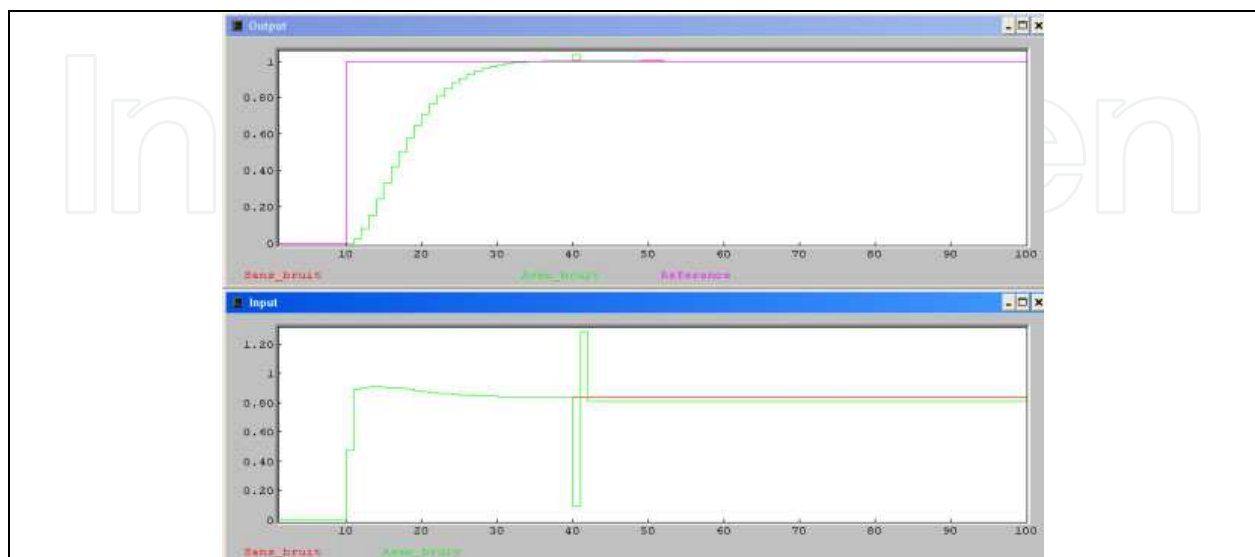

Fig. 11. Step response under and without disturbance.

2.2.3 Reaction temperature control

The temperature is a parameter representative for the chemical and petrochemical processes, with the transfer of heat, in temperature control systems, the mathematical model will be calculated for heat transfer of the product which will be heated or cooled, the structure of an SRA for temperature is given in figure (12) (Ben Abdennour, 2001).

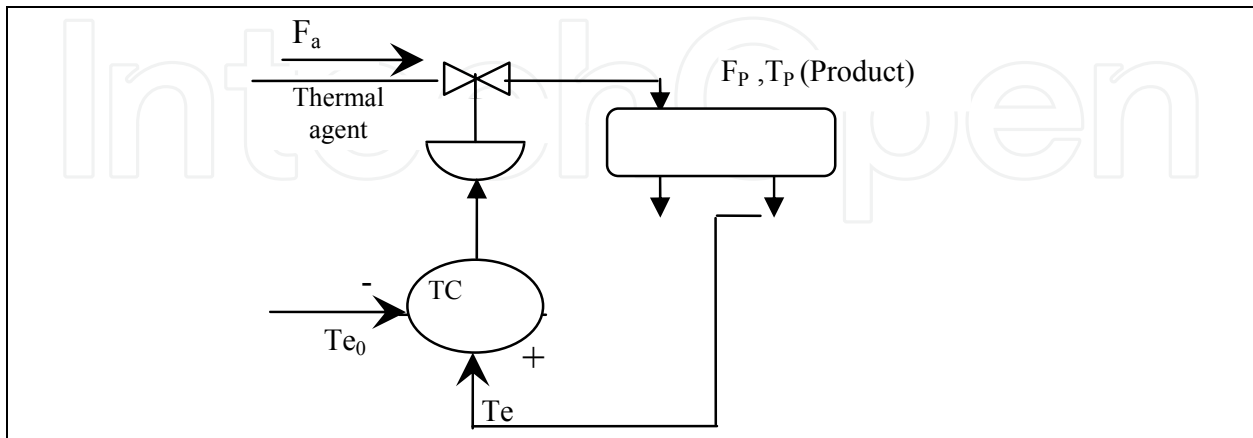

Fig. 12. Temperature control

Where

F: flow of heating agent

Ta: temperature of heating agent

Fp: product flow

Tp: temperature of product

Te: temperature alloy

TE0: required value for the temperature

According to the estimation of polynomial degrees, one could deduct that A is a second degree polynomial and B is of the first degree, the results of the identification and control by WinPim and WinReg respectively are:

Model

Structure of model of identification system: ARX

Identification method: recursive least squares

Adaptation algorithm parametric decreasing gain

Te=5s

Delay: D=0

$$H(q^{-1}) = \frac{B(q^{-1})}{A(q^{-1})} = \frac{0.00597q^{-1}}{1 - 1.683q^{-1} + 0.707q^{-2}} \quad (47)$$

Controller

Control method: Poles placement

$$R(q^{-1}) = 160.81q^{-1} - 276.03q^{-2} + 118.475q^{-3} \quad (48)$$

$$S(q^{-1}) = 1 - q^{-1} \tag{49}$$

$$T(q^{-1}) = 167.504 - 288.712q^{-1} + 124.463q^{-2} \tag{50}$$

Reference model

$$A_m(q^{-1}) = 1 - 0.446q^{-1} + 0.05q^{-2} \tag{51}$$

$$B_m(q^{-1}) = 0.442 + 0.161q^{-1} \tag{52}$$

The Nyquist diagram with the location of poles in closed loop of figure (13) are taken in two different cases of treatment, they show the difference between a controller without pre-specification of performance given above, and a robust controller that is given later by adding a few performances (Ogata, 2001).

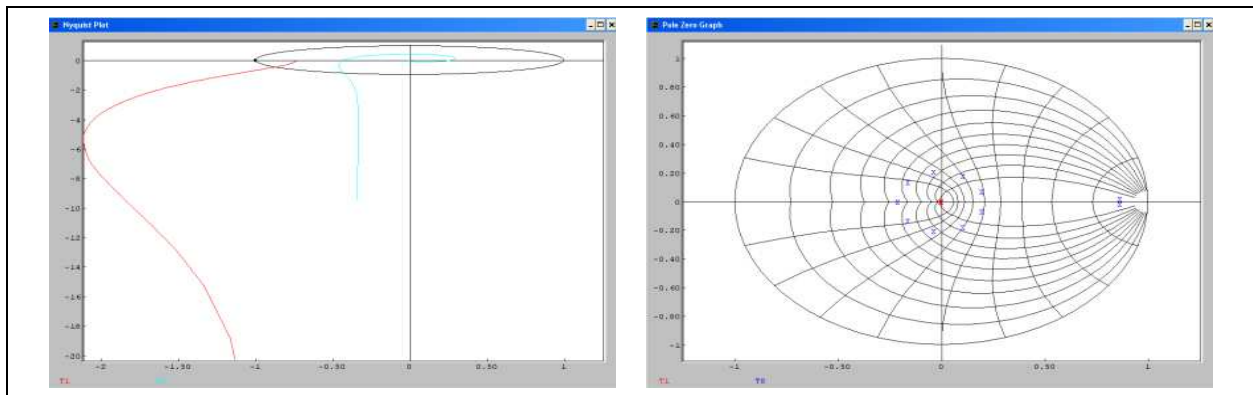

Fig. 13. Nyquist diagram and closed-loop poles.

The performances specification in tracking and further control to clarify the dominant auxiliary poles of the closed loop are successively represented in table (2).

Nr	Traking		Regulation		HR		HS			
	Double		Double		Simple		Double		Simple	
	w ₀	xi	w ₀	xi	T	n	w ₀	xi	T	n
1	0.3	1	0.3	0.99						
2	0.3	1	0.3	0.99			0.4	0.7	5	2
3	0.3	1	0.3	0.99						
4	0.3	1	0.3	0.99	6	1	0.5	0.1	5	1
5	0.3	1	0.3	0.99			0.5	0.5		
6							0.5	0.55	5	1
7	0.3	1	0.3	0.99			0.5	0.6	5	2
							0.5	0.65		
8	0.3	1	0.3	0.99			0.45	0.9	1	1
							0.45	1		
							0.45	1		

Table 2. Performances specification.

Robustness margins which correspond to the previously specified performances are reported in table (3), the goal here is to change the performance so that the obtained margins can be maintained in the range of the known robustness margins.

Nr	ΔG (dB)	$\Delta\Phi$ (°)	$\Delta\tau$ (s)	ΔM (dB)
1	6.22	63.0	5.42	-5.83
2	4.37	55.6	5.75	-8.06
3	6.22	63.0	2.33	-7.50
4	6.71	32.0	4.05	-7.76
5	5.5	30.2	2.55	-7.30
6	7.99	61.8	8.37	-4.80
7	6.85	60.7	10.66	-5.45
8	6.04	54.8	12.12	-6.13

Table 3. Successive improvement of robustness margins.

The new polynomial of the controller with the reference model are given as follows:

Controller

$$R(q^{-1}) = 187.56q^{-1} - 256.13q^{-2} - 30.06q^{-3} + 87.18q^{-4} + 77.22q^{-5} - 78.80q^{-6} + 1629q^{-7} \quad (53)$$

$$S(q^{-1}) = 1 - 1.16q^{-1} - 0.39q^{-2} + 0.35q^{-3} + 0.34q^{-4} - 0.14q^{-5} \quad (54)$$

$$T(q^{-1}) = 167.504 - 288.712q^{-1} + 124.463q^{-2} \quad (55)$$

Reference model

$$Am(q^{-1}) = 1 + 1.06q^{-1} + 0.35q^{-2} \quad (56)$$

$$Bm(q^{-1}) = 0.32 + 0.71q^{-1} \quad (57)$$

To simulate the behavior of the controller, the given step response of the reference model must be used by considering the existence of a disturbance step type, with amplitude of $2.5 \cdot 10^{-3}\%$, applied at time 40s, a graphical representation of the step response with and without disturbance is shown in figure (14), in which the assurance of performance in tracking and control can be observed.

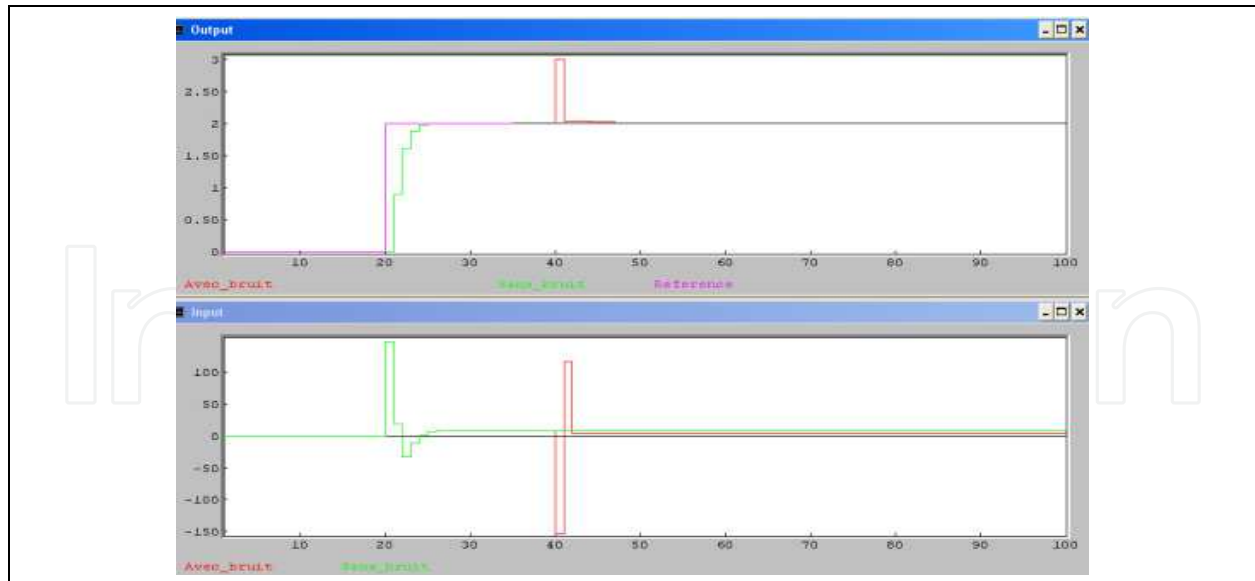

Fig. 14. Step response under and without disturbance.

3. Conclusion

The realized study case on the pyrolysis reactor validates the research developed in this chapter and provides a guarantee for the successful implementation of the control solutions proposed for such plants (Azzouzi, 2009a). On one hand, there are analyzed the theoretical and practical resources offered by modern Automatic Control in order to achieve the effective solutions for the control of this chemical process, and on the other hand, there are presented mechanisms related to the design and to the implementation of systems for data acquisition, identification, control and robustness (Azzouzi, 2008).

4. References

- Azzouzi, M. & Popescu, D. (2008). Optimisation d'un réacteur de pyrolyse par SiSCon, *Conférence Internationale Francophone d'Automatique CIFA'2008*, Bucharest, June 2008
- Azzouzi, M. (2008). Systèmes numériques pour la commande avancée des installations pétrolières et pétrochimique, PhD Thesis, Politehnica University of Bucharest, Bucharest
- Azzouzi, M. (2009a). Medium optimization approach on petrochemical plant, *The 17th Conference on Control Systems and Computer Science, CSCS-17*, Vol. 2, pp159-163, Bucharest, May 2009
- Azzouzi, M. (2009b). Comparative study between SisCon and MatLab in pyrolysis reactor identification, *Journal of Applied Functional Analysis (JAFA)*, pp255-261
- Ben Abdennour, R. (2001). *Identification et commande numérique des procédés industriels*, pp. 210-240, Technip, Paris
- Borne, P., Tanguy, G. D., Richard, J. P., Rotelle, F. & Zambittakis, C. (1993). *Analyse et régulation des processus industriels; tome 2: Régulation numérique*, pp. 267-275, Technip, Paris
- Bozga, G. & Muntean, O. (2000). *Reactoare chimice (reactoare omogene)*, vol. I, pp470-480. Tehnica, Bucharest

- Harriott, P. (2002). *Chemical reactor design*, pp. 131-142. CRC First Edition, New York
- Landau, Y. D. & Zito, Gianluca. (2006). *Digital Control Systems: Design, Identification and Implementation*, pp. 267-291, First Edition of Springer, Paris
- Ogata. K. (2001). *Modern control engineering*, pp. 310-431. Prentice Hall fourth Edition, New York
- Oustaloup, A. (1994). *La robustesse: Analyse et synthèse des commandes robustes*, pp. 150-102, Hermes, Paris
- Popescu, D., Lupu, C., Petrescu, C. & Matescu, M. (2006b). *Sisteme de Conducere a proceselor industriale*, pp. 24-29, Printech, Bucharest
- Popescu, D., Stefanoiu, D., Lupu, C., Petrescu, C., Ciubotaru, B. & Dimon, C. (2006a). *Industrial Automation*, Agir, Bucharest

IntechOpen

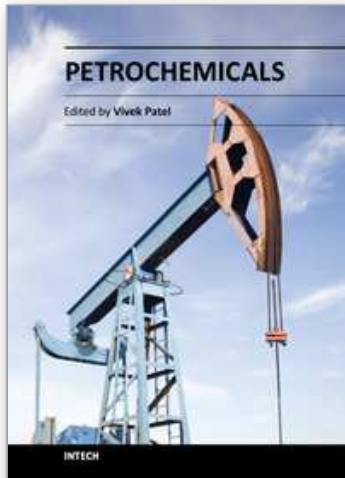

Petrochemicals

Edited by Dr Vivek Patel

ISBN 978-953-51-0411-7

Hard cover, 318 pages

Publisher InTech

Published online 28, March, 2012

Published in print edition March, 2012

The petrochemical industry is an important constituent in our pursuit of economic growth, employment generation and basic needs. It is a huge field that encompasses many commercial chemicals and polymers. This book is designed to help the reader, particularly students and researchers of petroleum science and engineering, understand the mechanics and techniques. The selection of topics addressed and the examples, tables and graphs used to illustrate them are governed, to a large extent, by the fact that this book is aimed primarily at the petroleum science and engineering technologist. This book is must-read material for students, engineers, and researchers working in the petrochemical and petroleum area. It gives a valuable and cost-effective insight into the relevant mechanisms and chemical reactions. The book aims to be concise, self-explanatory and informative.

How to reference

In order to correctly reference this scholarly work, feel free to copy and paste the following:

Azzouzi Messaouda and Popescu Dumitru (2012). Chemical Reactor Control, Petrochemicals, Dr Vivek Patel (Ed.), ISBN: 978-953-51-0411-7, InTech, Available from:

<http://www.intechopen.com/books/petrochemicals/chemical-reactor-control>

INTECH
open science | open minds

InTech Europe

University Campus STeP Ri
Slavka Krautzeka 83/A
51000 Rijeka, Croatia
Phone: +385 (51) 770 447
Fax: +385 (51) 686 166
www.intechopen.com

InTech China

Unit 405, Office Block, Hotel Equatorial Shanghai
No.65, Yan An Road (West), Shanghai, 200040, China
中国上海市延安西路65号上海国际贵都大饭店办公楼405单元
Phone: +86-21-62489820
Fax: +86-21-62489821

© 2012 The Author(s). Licensee IntechOpen. This is an open access article distributed under the terms of the [Creative Commons Attribution 3.0 License](#), which permits unrestricted use, distribution, and reproduction in any medium, provided the original work is properly cited.

IntechOpen

IntechOpen