

We are IntechOpen, the world's leading publisher of Open Access books Built by scientists, for scientists

5,500

Open access books available

135,000

International authors and editors

165M

Downloads

Our authors are among the

154

Countries delivered to

TOP 1%

most cited scientists

12.2%

Contributors from top 500 universities



WEB OF SCIENCE™

Selection of our books indexed in the Book Citation Index
in Web of Science™ Core Collection (BKCI)

Interested in publishing with us?
Contact book.department@intechopen.com

Numbers displayed above are based on latest data collected.
For more information visit www.intechopen.com



Realization of HDWDM Transmission System with the Minimum Allowable Channel Interval

Jurgis Porins, Vjaceslavs Bobrovs and Girts Ivanovs
*Riga Technical University, Institute of Telecommunications
 Latvia*

1. Introduction

Nowadays, a skyrocketing growth is observed worldwide in the bit rates of transmitted information, which is associated with development of broadband information transmission types. The annual global internet protocol (IP) traffic will exceed half a Zettabyte in four years. At just under 44 Exabytes per month, the annual run rate of traffic in the late 2012 will be 522 Exabytes per year. Driven by high-definition video and high-speed broadband penetration, the consumer of IP traffic will bolster the overall IP growth rate so that it sustains a steady growth rate through 2012, growing at a compound annual growth rate (CAGR) of 46 percent (see Fig. 1) [Cisco Systems, 2008].

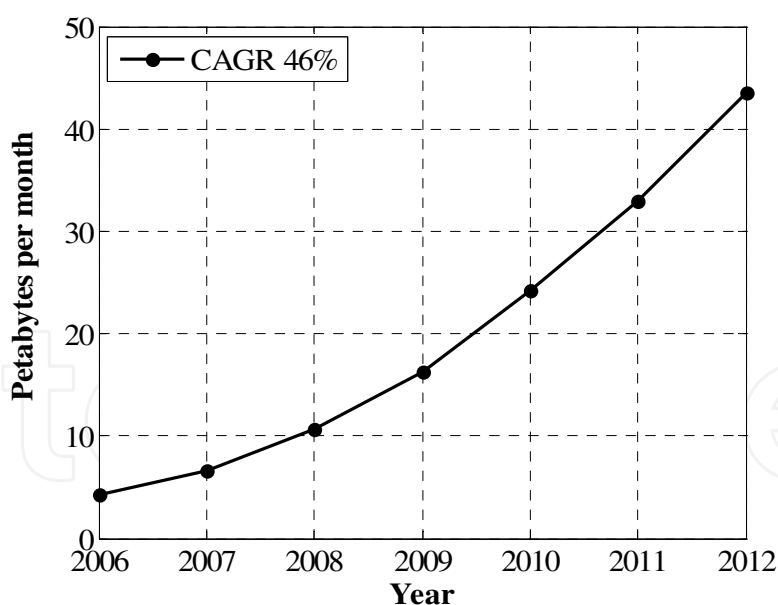

Fig. 1. Global IP Traffic Forecast (2006–2012) [Cisco Systems, 2008].

In turn, to provide high-quality transmission it is necessary to develop the next generation optical networks (NGONs) that would transmit properly huge volumes of information. The optical transmission systems from the very outset have been able to offer new possibilities for solving problems of ever increasing urgency that are dictated by the need for frequency bands and transmission speed. Such networks have become one of the most important

components in the telecommunication hierarchy, whose integration with standard network services and applications promotes rapid evolution of fiber optics and its wide implementation into all telecommunication branches (see Table 1 [McGloin & Reid., 2010]).

Transmission Network	CORE	METRO	ACCESS	CROSS CONNECTIONS
Length	> 100 km	10 km	Approx. 20 km (ITU recommendation), normally < 10 km	< 100 m
Laser type	DFB	DFB, VCSEL	DFB or Fabry-Perot	VCSEL
Wavelength	1550 nm central \pm 30 nm	1310 nm; 1550 nm	1310 nm; 1490 nm; 1550 nm	850 nm; 1310 nm
Modulation scheme	External	External or internal	Internal	Internal
Bit rate	10 Gbit/s	10 Gbit/s	< 2.5 Gbit/s	Depending on protocol type
Multiplexing scheme	DWDM or CWDM	CWDM	WDM	Depending on protocol type

Table 1. Evolution of fiber optics and its wide implementation into all telecommunication branches

Currently, many research topics in the field of optical transmission systems (mostly grounded on novel modulation techniques) are focused on increasing the total data transmission speed of an individual optical fiber [Abbou et al., 2008, Bhamber et al., 2007, Bobrovs et al., 2008]. An alternative – but equally valid – approach to increasing the data transmission is to decrease the wavelength division multiplexing (WDM) channel spacing to high-dense dimensions while keeping the existing data transmission speed for an exact channel [Ozoliņš et al., 2011, Bobrovs et al., 2009].

High performance optical filters make the groundwork for realization of high-speed high-density WDM (HDWDM) transmission systems [Pfennigbauer & Winzer, 2006]. High channel spacing and data transmission rate set strict requirements for HDWDM filter characteristics, so any imperfections in their parameters, such as amplitude and phase responses, could become critical. The low channel separation from adjacent channels is one of these imperfections in optical filter parameters [Agrawal, 2001, Ozoliņš et al., 2009].

2. Implementation of HDWDM transmission system

Due to these rapidly growing capacity requirements for long-haul transmission, the optical wavelength division multiplexing systems are advancing into high data transmission rate and dense channel spacing to utilize the available bandwidth more effectively. In order to maximize the system capacity and to minimize the performance degradation caused by transmission impairments the system investigation and optimization are very important. To increase the spectral efficiency is important for building efficient HDWDM transmission systems, since this allows the optical infrastructure to be shared among many wavelengths. This approach reduces the cost per transmitted information bit in a fully loaded and optimized transmission system.

2.1 Selection of HDWDM main components

The complexity of a system's design in optical communications can be seen as the result of a large number of components with different parameters and operational states. The description of the interaction between the optical signal and transmission disturbances is a multi-dimensional issue, whose solution depends on the relation between different system parameters. The right approach to the optimization of system settings and derivation of design rules must take into account the interaction of effects which take place in each component. In this section, the system components needed for realization of an HDWDM transmission system are described.

The role and realization of an optical transmitter become important with increased channel data rates in the system. While the optical transmitters at lower channel data rates are less complex and easier to realize by direct modulation of a laser diode, the realization becomes more complex with the increasing channel data rate, thus raising the requirements on electrical and optical components of the optical transmitter. The conventional optical transmitter employs the amplitude/intensity modulation (AM, IM) of the laser light (better known as on-off keying (OOK)), because different signal levels for marks and spaces are characterized by the presence of optical power. The amplitude modulation can be realized by direct or external modulation of the laser diode. For the realization of transmission systems with channel data rates larger than 2.5 Gbit/s, the external modulation presents a better solution, because the impact of laser internal chirp on optical signal can be reduced efficiently, but, on the other hand, the complexity of optical transmitters increases.

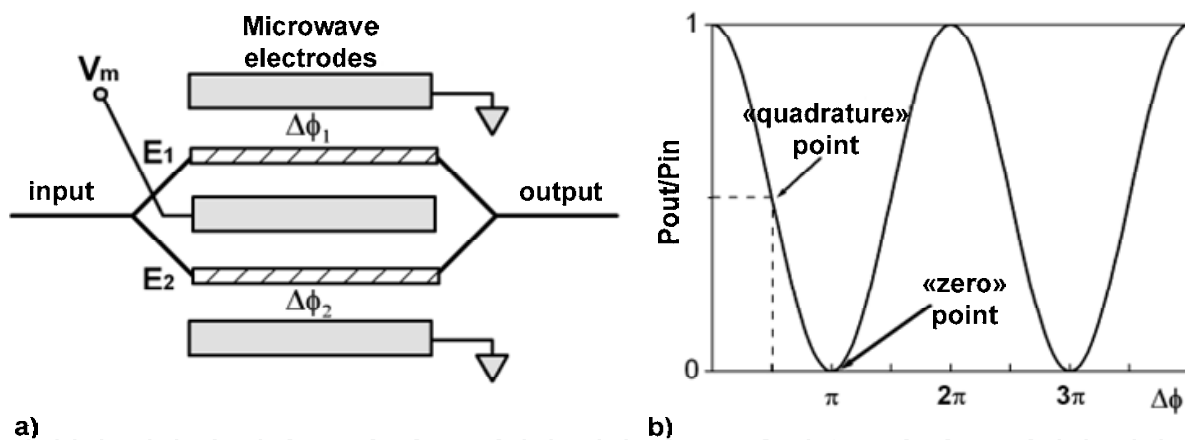

Fig. 2. Mach-Zehnder Modulator (MZM) principles: a) structure b) transmission function [Kaminow et al., 2009].

External modulation can be realized with a LiNbO_3 -based Mach-Zehnder modulator (MZM) (see Fig. 2) [Kaminow et al., 2009]. The operational principles of MZMs are based on the electro-optic effect, which is characterized by variation in the applied electrical field causing changes of the refractive index in the modulator arms. The variation of the refractive index in the modulator arms induces a change of material propagation constant β , resulting in different phases in both modulator arms. The input optical signal is divided by a 3-dB coupler into two equal parts - in lower and upper arm of the MZM. The external modulator is driven by an electrical signal with corresponding data rate. Depending on the electrical driving signal,

different transmission speeds can be realized. If no electrical field is applied, both signals arrive at the same time (in-phase) at the MZM output and interfere constructively. If an electrical field is applied, signals in different arms are shifted in phase relative to each other. Depending on the phase difference between the MZM arms, the signals can interfere constructively or destructively, resulting in an amplitude modulation of the modulator input signal. In this signal generation method, the laser source acts as a continuous wave (CW) pump. In conventional systems, the CW pumps are realized with distributed feedback laser (DFB) (the most important and widely used single mode laser type for the 1550 nm region). DFB lasers are realized by the implementation of through a Bragg's grating structure inside the cavity between the reflecting surfaces of a laser [Voges & Petermann, 2002]. The main characteristics of the DFB lasers are high side-mode suppression ratios (> 50 dB) enabling stable single-mode operation, a small spectral line width (0.8...50 MHz) and large output optical power (10...40 mW) (see Fig. 3) [Funabashi, 2001].

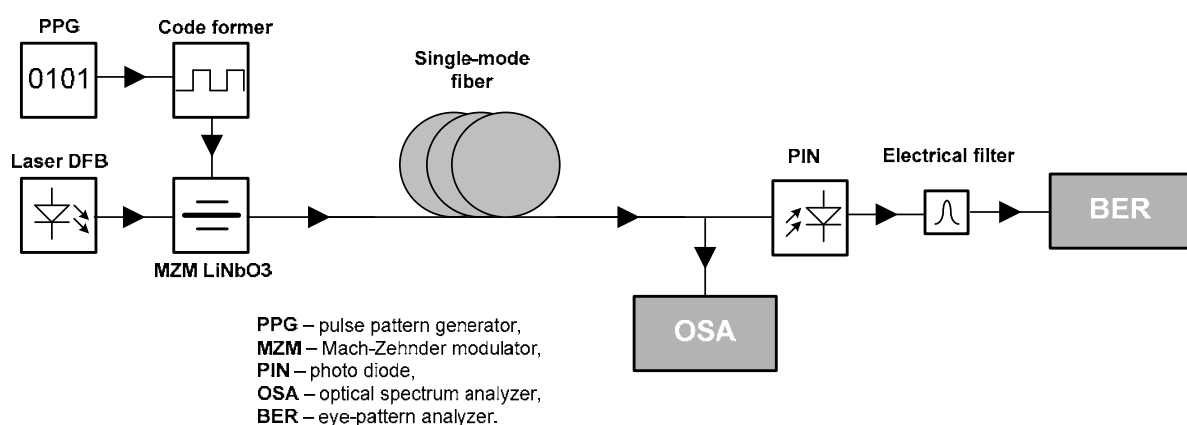

Fig. 3. Simplified fiber optical transmission system.

After the MZM, such a signal is sent directly to a transmission medium, where optical pulses are propagating over different distances of a single-mode fiber (SMF). For compensation of losses in the fiber and in optical components it is necessary to use the technique for amplifying optical signals. The optical amplifiers represent one of the crucial components in an optical transmission system. Despite the minimum attenuation at 1550 nm, fiber losses significantly limit the transmission performance with increased transmission distance. Optical amplification can be realized using different amplifier concepts and mechanisms, e.g. semiconductor optical amplifiers (SOA), rare-earth (erbium, holmium, thulium, and samarium) doped fiber amplifiers, or, more recently, Raman amplifiers [Kaminow et al., 2008, Binh, 2008]. All these amplifier types are based upon different physical mechanisms resulting in different device characteristics and application areas. The rare-earth-doped fiber amplifiers provide optical amplification in the wavelength region from 500 to 3500 nm. The most important representative of these amplifier types is the erbium-doped fiber amplifier (EDFA), which is widely used today in optical transmission systems since it provides efficient optical amplification in the 1550 nm region. The EDFAs present the state-of-the-art technology in conventional optical transmission systems, and they can be used as in-line amplifiers (placed every 30-80 km), power boosters (amplifiers at the transmitter side) or pre-amplifiers (amplifiers in front of the receiver) independently of the channel bit rate in the system [Thyagarajan & Ghatak, 2007].

After transmission through the optical fiber, a multiwavelength optical signal needs to be separated in individual channels. This is realized through implementation of band-pass filters (BPFs), which transmit optical power within a definite wavelength window only, and reflect or absorb the rest. In the case of a single-channel transmission the function of an optical BPF is to separate the channel information from the noise which has been added, e.g., by optical amplifiers. This noise is generally broadband, and can often be described as quasi-white: it has a constant level in the power spectrum [Kashyap, 2010, Venghaus, 2006]. By applying a BPF to select the wavelength channel, the useful information is retained and most of the noise is filtered resulting in an improvement of the optical-signal-to-noise ratio (OSNR). Such a filter can also be used to select a particular channel in a HDWDM application from several channels that are transmitted in a common HDWDM transmission system [Azadeh, 2009, Venghaus, 2006]. The role of an optical receiver is to detect the transmitted signal by the opto-electrical transformation of the signal received by a photodiode (e.g. PIN or APD). Furthermore, additional electrical equalization is performed together with electrical signal amplification enabling further signal-processing (e.g. clock-recovery) and performance evaluation (e.g. quality measurements).

In fiber optical transmission systems, the degradation effects can be categorized by the random noise and waveform distortion. For long-span HDWDM systems, signal waveform distortion can be generated by linear chromatic dispersion, polarization mode dispersion (PMD), nonlinear optical effects (NOE) in optical fibers, or their combination [Chen et al., 2006, Pan et al., 2010]. In high-speed (more than 2.5 Gbit/s) time division multiplexing (TDM) optical systems having short optical pulses and wide optical spectrum the effect of complex dispersion dominates in the system performance degradation. In multiwavelength WDM optical systems the inter-channel crosstalk originated by fiber nonlinearity, such as cross-phase modulation (XPM) and four-wave mixing (FWM), is a limiting factor. To maximize the WDM network capacity, the system's design and optimization have to take into account all the contributing factors - such as the channel data rate, transmission distance, signal optical power, fiber linear and nonlinear optical effects and, of course, the channel interval [Venghaus, 2006]. In a HDWDM system the last factor is the most important for a high-quality solution which depends directly on the optical filters.

2.2 Optical filters for HDWDM systems

The wavelength filters in optical transmission systems are a special subgroup of physical components defined in such a way that they select or modify parts of the signal spectrum. In fact, the optical wavelength filters are defined as referred to the modifications that they induce in the frequency spectrum. In electronic systems, relevant filters play a crucial role in numerous signal processing applications. Similarly, optical filters play an equally crucial role in the optical domain [Venghaus, 2006, Kaminow et al., 2008].

Multiplexing and de-multiplexing functions are performed by narrowband filters, cascaded and combined in various ways to achieve the desired result. The filters in optical HDWDM transmission systems are classified into the following types: notch filters, power equalization filters, all-pass filters and band-pass filters [Szodenyi, 2004].

As was said above in sub-section 2.1, band-pass filters (BPFs) transmit optical power within a definite wavelength window only, and reflect or absorb the rest. The bandwidth of an optical

BPF typically depends on the optical transmission system type [Venghaus, 2006]. For example, in HDWDM the sharpness of the optical BPF amplitude transfer function is of great importance, while in the coarse wavelength division multiplexing (CWDM) it is a minor factor because of a wide frequency interval between the adjacent channels. In these systems the major role is played only by the optical BPF bandwidth, and in the DWDM systems also the shape of the amplitude and phase transfer function should be taken into account. Although different kinds of filters are necessary in a HDWDM transmission system, BPFs are by far the most important, since they are prerequisite for add and drop, multiplex, interleave and routing functionalities which are essentials for a HDWDM transmission system realization [Agrawal, 2001].

Travelling through a multiple optical BPF, the optical signal experiences spectral narrowing due to temperature instability of filtering devices and to central frequency fluctuations of light sources, which could be the main factor of degradation in future transmission systems. Therefore, it is necessary to find out the minimal filter's full width half maximum (FWHM) which ensures appropriate quality of transmitted data signals. Still, the filter bandwidth is not the exclusive parameter of which we need to be aware: the phase transfer function of optical band-pass filters is also of great importance for transmitting information via HDWDM transmission systems.

It is possible to employ three different transfer functions of the optical filter (see Fig. 4) for realization of HDWDM system schemes. These functions were chosen because with the Lorentzian optical filter's transfer function we can approximate: Fabry Perrot filters, micro-ring resonators; raised cosine filters: arrayed waveguide gratings with flat tops, diffraction gratings, and particular cases of thin film filters and fiber Bragg gratings (with apodization); supergaussian filters: arrayed waveguide gratings with supergaussian transfer function, and thin film filters with low refractive index modulation [Venghaus, 2006].

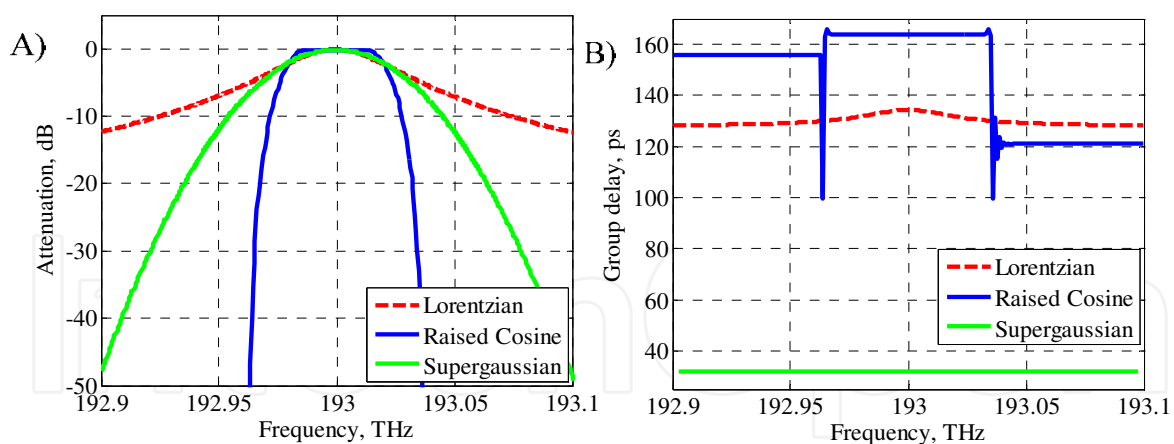

Fig. 4. First-order amplitude transfer (a) and group delay (b) functions of different optical filters shown in the inset (with FWHM bandwidth 0.4 nm or 50 GHz).

The graphs are obtained by/using OptSim simulation software.

As is seen from Fig. 4b, the greater group delay is for the Raised Cosine optical band-pass filter whose amplitude characteristics are the closest to an ideal filter's amplitude parameters. The ideal amplitude transfer function of a band-pass filter has an almost rectangular shape, providing a perfect transmission (without distortion) of the whole signal within the filter bandwidth, and cutting undesired signals out of the band [Venghaus, 2006].

3. Performance evaluation criteria

The right choice of the performance evaluation criteria for characterizing the optical transmission lines is one of the key issues in designing efficient high-speed systems. The evaluation criteria should provide precise determination and separation of dominant system limitations, which is crucial for suppressing the propagation disturbances. They should also provide comparison of experimental and numerical data to verify the numerical models applied.

3.1 Evaluation of bit error ratio (BER)

The bit error ratio (BER) evaluation is a straightforward and relatively simple method for performance evaluation based on counting the errors in the received bit streams. The error counting in a practical system with a transmission speed greater than 1 Gbit/s can be a long process, especially for realistically low BER values ($< 10^{-9}$). For investigation of performance of an optical transmission system by simulation, several effective statistical methods have been developed [Binh, 2009].

Conventional methods of Q-factor and hence BER calculation are based on the assumption of Gaussian noise distribution. However, new methods relying upon statistical processes with account for the distortion dynamics of optical fibers are necessary in order to include the common patterning effects.

The former statistical technique employs the expected maximization theory in which the *pdf* of the detected electrical signal is approximated as a mixture of multiple Gaussian distributions.

The latter technique is based on the generalized extreme values (GEV) theorem [Bierlaire et al., 2007, Markose & Alentorn, 2007]. Although this theorem is well-known in other fields (financial forecasting, meteorology, material engineering, see e.g. [Kotz & Nadarajah, 2000]) to predict the probability of occurrence of extreme values, it has not yet been applied in optical communications.

Exactly as the BER set used in experimental transmission, the BER in the simulation of a particular HDWDM system configuration is calculated. In this case the BER is the ratio of the occurrence of errors (N_{error}) to the total number of transmitted bits (N_{total}) and given as:

$$BER = \frac{N_{\text{error}}}{N_{\text{total}}} \quad (1)$$

The Monte-Carlo method offers a precise picture via the BER metric for all modulation formats and receiver types. The optical system configuration under a simulation test must include all the sources of impairments imposing on signal waveforms, including fiber impairments and amplified spontaneous emission (ASE) [Binh, 2009].

3.2 Optical signal-to-noise ration (OSNR)

The optical signal-to-noise ratio (OSNR) is a widely used evaluation criterion for characterizing the system performance in already deployed transmission lines. The optical noise created by transmission media and devices around an optical signal reduces

the receiver's ability to correctly detect the signal. This effect can be suppressed by an optical filter placed before the optical receiver. Depending on the amplifier infrastructure used in a transmission system, the OSNR is proportional to the number of optical amplifiers and to the gain flatness of a single amplifier. This latter can be an especially critical issue in HDWDM systems, because of the gain non-uniformity in multi-span transmissions.

In practice, the OSNR can be found by measuring the signal power as the difference between the total power of the signal peak and the background noise; this latter, in turn, is determined by measuring the noise contributions on either side of the signal peak. However, it is difficult to separate measurements of the signal and noise power, because the latter in an optical channel is included in the signal power. The determination of this parameter in a HDWDM system can be made by interpolating it between the adjacent channels [Binh, 2009].

For a single EDFA with output power, P_{out} , the OSNR is given by [Jacobsen, 1994]:

$$OSNR = \frac{P_{out}}{N_{ASE}} = \frac{P_{out}}{(NF G_{op} - 1) h \nu B_o}, \quad (2)$$

where NF is the amplifier noise figure, G_{op} is the optical amplifier gain, $h\nu$ is the photon energy, and B_o is the optical bandwidth found by measurement. However, OSNR does not provide good estimation to the system performance when the main degrading sources involve the dynamic propagation effects such as dispersion and Kerr nonlinearity effects.

When addressing the value of an OSNR, it is important to define the optical measurement bandwidth over which the OSNR is calculated. To obtain this value, the signal power and noise power are derived by integrating all the frequency components over the bandwidth [Rongqing & O'Sullivan, 2009].

In practice, the signal and noise power values are usually measured directly, using the optical spectrum analyzer (OSA), which does the mathematics for the users and displays the resultant OSNR versus wavelength or frequency over a fixed resolution bandwidth. The value of $\Delta\lambda = 0.1$ nm at 1550 nm, is widely used as a typical value for calculation of the OSNR.

4. HDWDM system experimental and simulation models

Our experimental transmission system (see Fig. 5) employs two optical channels with external intensity modulation (IM), and non-return-to-zero (NRZ) pulse shapes. The laser is always switched on and its light waves are modulated via the electro-optic MZM by output of data pulse sequence of a pulse pattern generator (PPG), using the principles of interferometer constructive and destructive interference to achieve ON and OFF of the light waves. After the MZ modulator the signal is sent to a single-mode fibre (SMF), where optical pulses are propagating over a 40 km distance. The utilized fiber has a large core effective area of $80 \mu\text{m}^2$, attenuation $a = 0.2$ dB/km, nonlinear refractive coefficient $n_k = 2.5 \cdot 10^{-20}$ cm/W and dispersion 16 ps/nm/km at the reference wavelength $\lambda = 1550$ nm [Kaminow et al., 2009].

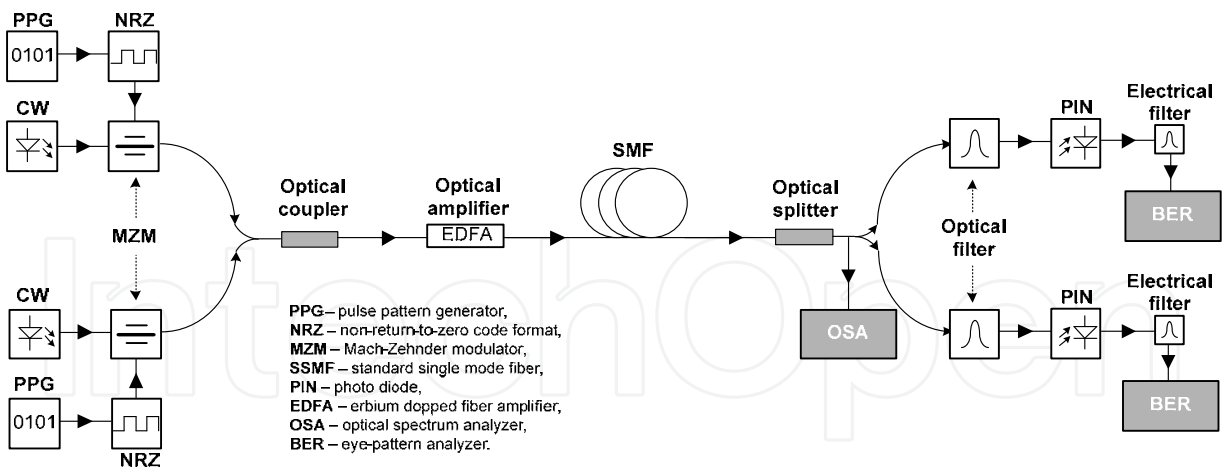

Fig. 5. The setup used for investigation of HDWDM transmission [Bobrovs et al., 2010].

At the fibre end each channel is optically filtered with an Anritsu Xtract tunable optical filter (see Fig. 6). An essential parameter of such a filter is its centering on the signal to be extracted. Its position has to be adjusted regarding the signal harmonics [Ivanovs et al., 2010].

The Anritsu Xtract tunable optical band-pass filter covers all transmission bands of a standard single mode optical fiber. The filter operates in the range of 1450-1650 nm, covering the E, S, C and L bands and, partially, the U band. The main drawback of this BPF is 6 dB insertion losses, which is a limiting factor in realization of high-speed HDWDM transmission systems for moderate distances without optical amplifiers.

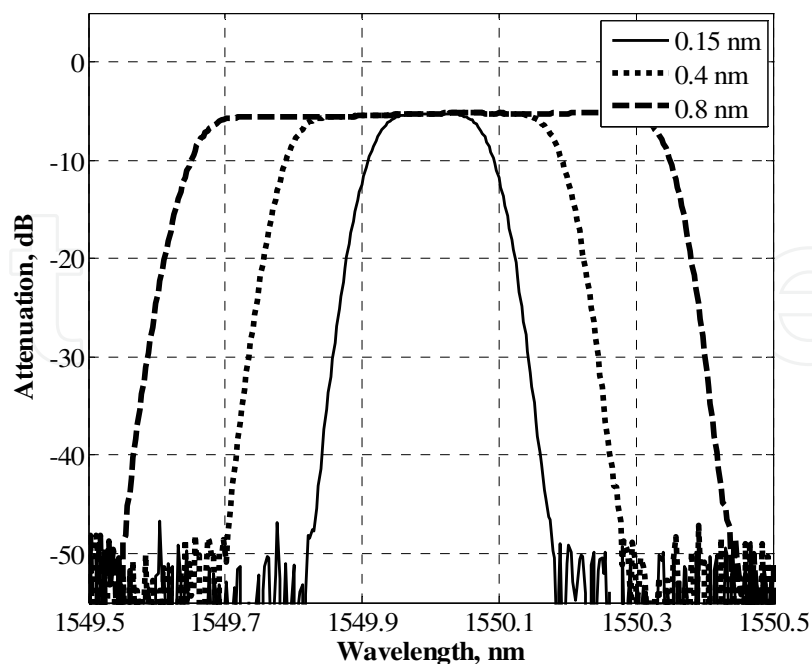

Fig. 6. The measured amplitude responses of the Anritsu Xtract tunable optical band-pass filter at different FWHM values.

To evaluate the output signal characteristics, an optical direct-detection receiver was used, with an electrical fourth-order Bessel–Thomson electrical filter having a 3 db bandwidth of 7.5 GHz. In practice, a 40 km span is preferred by most network providers since it allows a compromise between the system’s costs and its performance [Binh, 2009].

For the performance evaluation and optimization of the experimental HDWDM system it is necessary to analyze the optical and electrical signal quality before MZM, after MZM and after SMF. The choice of arbitrary units on the Y-axis in the eye diagrams was purposeful – to make them more general in the cases when the plotted electrical quantity is current or voltage.

As a result, we have designed a HDWDM transmission system with a variable data transmission speed up to 12.5 Gbit/s, the channel interval up to 12.5 GHz and optical power up to 23 dBm. In Fig. 7 one can see 2.5 Gbit/s HDWDM transmission systems with 18.75 GHz and 25 GHz channel interval. As follows from the results, reducing the channel interval to 18.75 GHz gives rise to Kerr’s effect, which degrades the 2.5 Gbit/s signal quality. The signal eye-pattern overlaps with the mask (see Fig. 7c), which means that the signal quality does not ensure the BER=10⁻⁹ value. To obtain a system with an appropriate BER we should reduce the data transmission speed or increase the channel interval. As can be seen from Fig. 5, the 25 GHz channel interval ensures a good signal quality, and the signal eye-pattern in this case does not overlap with the mask.

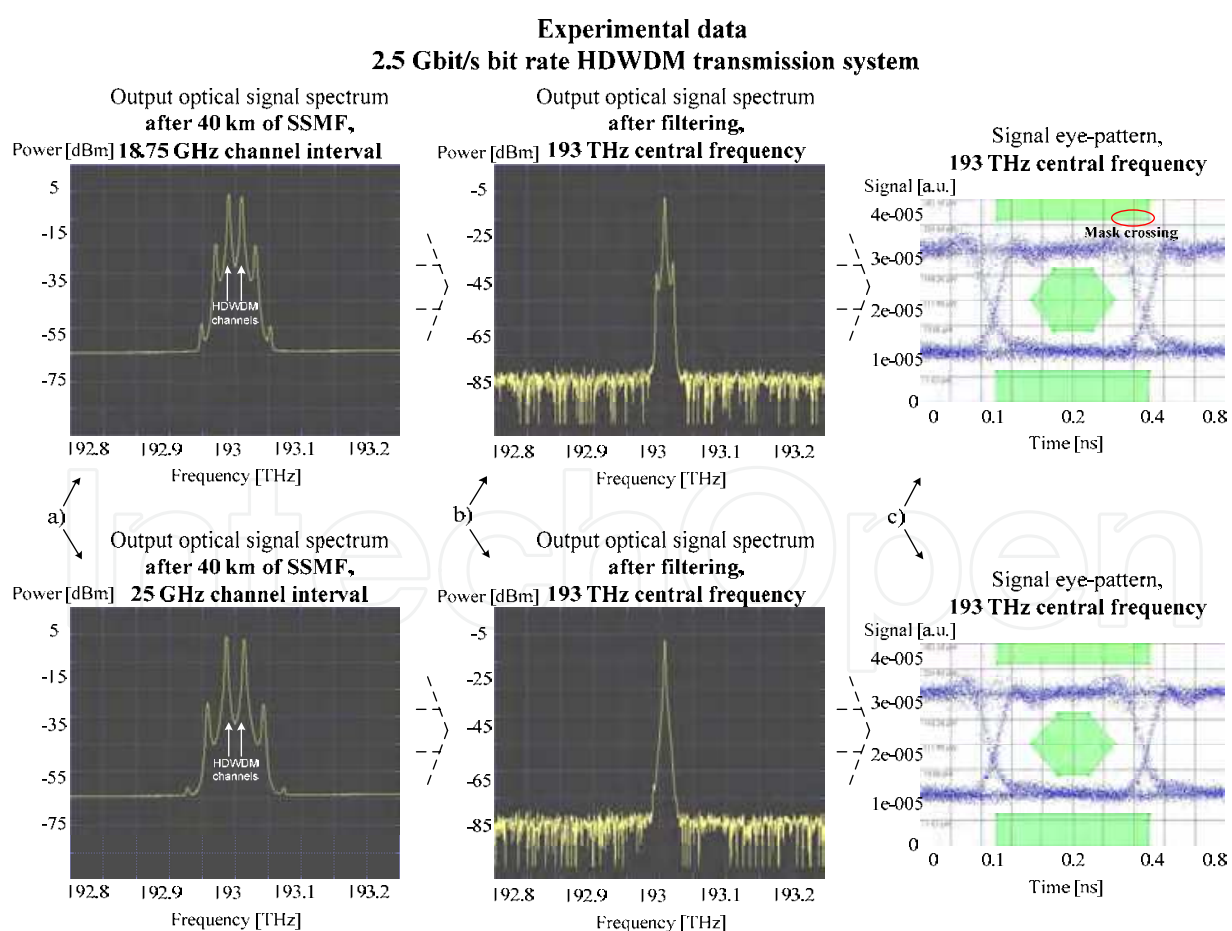

Fig. 7. Output optical signal spectra and eye-patterns with defined masks for 2.5 Gbit/s system: a) common optical spectra, b) signal optical spectrum after filtering, c) eye-pattern.

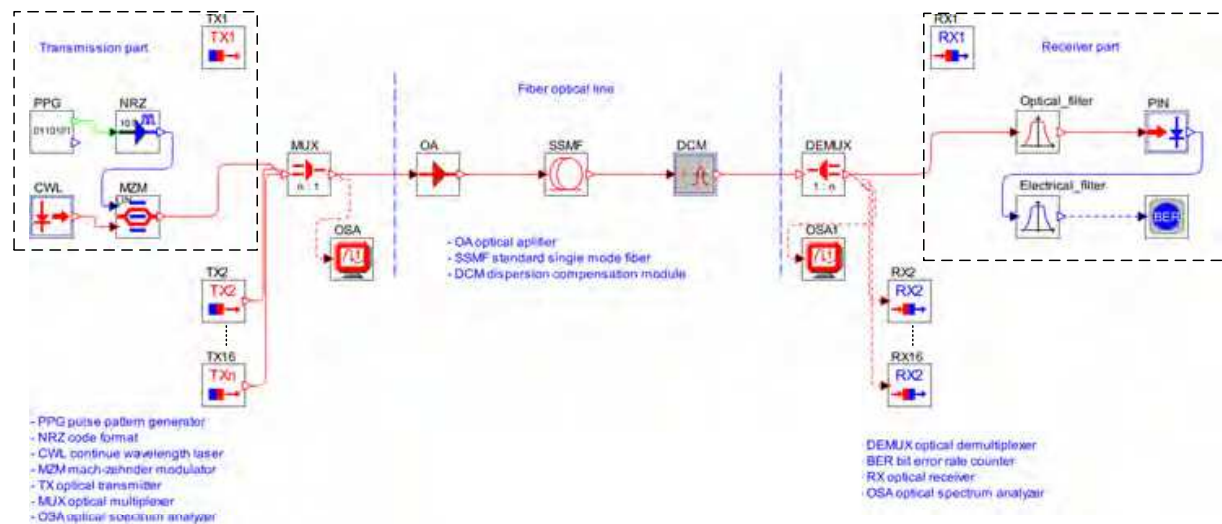

Fig. 8. Simulation model of HDWDM system.

In compliance with the experimental model we have created a simulation scheme (see Fig. 8) using OptSim software with the real parameters of all experimental devices. The accepted method of calculation is based on solving of a complex set of differential equations, taking into account optical and electrical noise as well as linear and nonlinear effects. We have used a model where signals are propagating as time domain samples over a selectable bandwidth (in our case, a bandwidth that contains all channels).

The Time Domain Split Step (TDSS) method was employed to simulate linear and nonlinear behavior for both optical and electrical components. The split step method is now used in all commercial simulation tools to perform the integration of a fiber propagation equation that can be written as [Binh, 2009]:

$$\frac{\partial A(t, z)}{\partial z} = \{L + N\} A(t, z) \quad (3)$$

Here $A(t, z)$ is the optical field, L is the linear operator that stands for dispersion and other linear effects, and N is the operator that is responsible for all nonlinear effects. The idea is to calculate the equation over small spans Δz of fiber by including either a linear or a nonlinear operator [Belai et al., 2006]. For instance, on the first span only linear effects are considered, on the second – only nonlinear, on the third – again only linear ones, and so on. Two ways of calculation are possible: frequency domain split step (FDSS) and the above-mentioned time domain split step (TDSS) method. These methods differ in how linear operator L is calculated: FDSS does it in a frequency domain, whereas TDSS – in the time domain, by calculating the convolution product in sampled time. The first method is easy to fulfill, but it may produce severe errors during computation. In our simulation we have employed the second method, TDSS, which, despite its complexity, ensures an effective and time-saving solution.

5. Results and discussions

Fig. 9 shows the spectral and eye diagrams in a simulative HDWDM communication system with 2.5 Gbit/s transmission speed per channel after a signal's detection. It is seen there that in

the four-channel case the allowed interval is 12.5 GHz or 0.1 nm, with BER meeting the standard ($< 10^{-9}$). If we raise the number of channels to 8, the output signal quality worsens; therefore, the channel interval should be raised up to 18.75 GHz (see Fig. 9). In turn, in the 16-channel case a successful transmission is possible only using 25 GHz (or 0.2 nm) channel spacing. This is the optimal channel interval, which allows multiplexing the signals in a HDWDM system with a channel number exceeding 16. Further increase in the channel number would not change the chosen frequency interval (see Fig. 9). Considering the 25 GHz frequency interval as the chosen one, it is possible to upgrade the existing WDM communication systems with a 2.5 Gbit/s transmission speed per channel without increasing this speed while decreasing the channel interval down to the estimated value and adding signals to the freed frequency range, thus realizing an HDWDM transmission system.

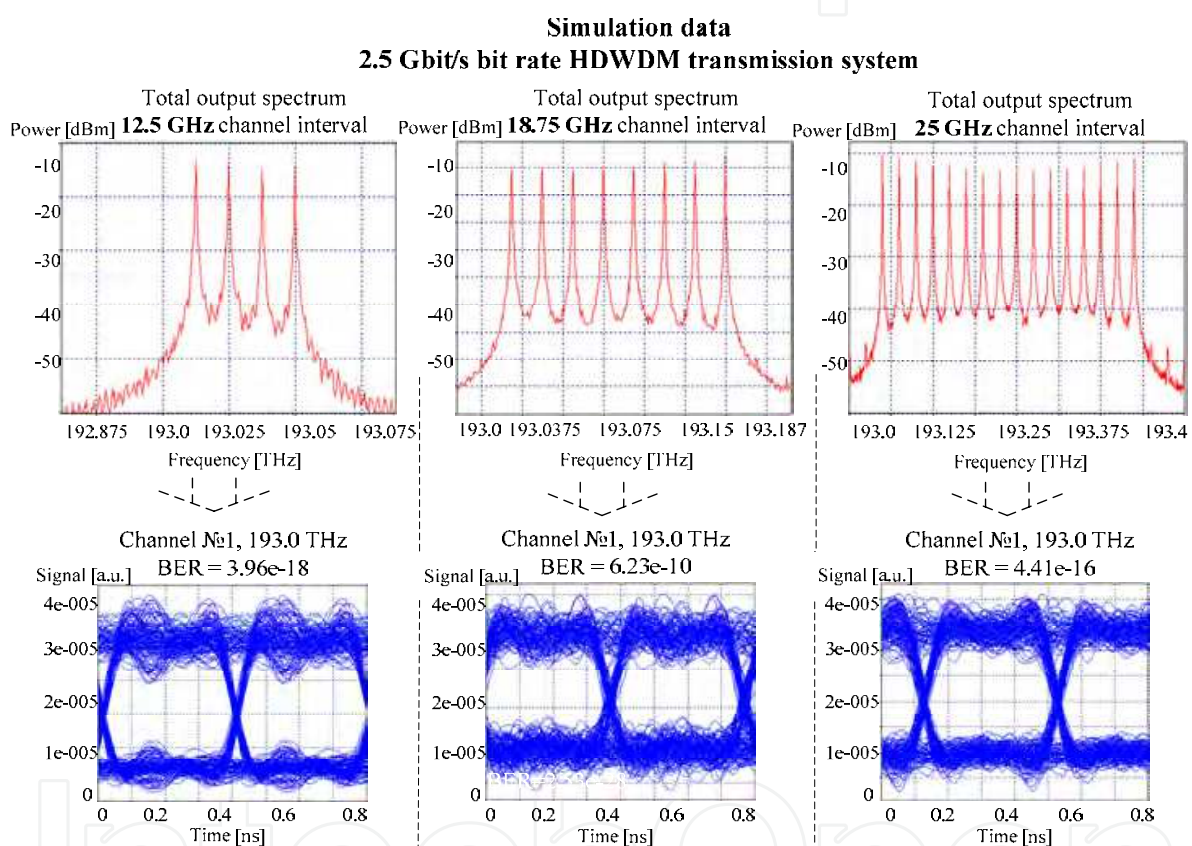

Fig. 9. 22.5 Gbit/s HDWDM communication system with 4/8/16 channels and 12.5/18.75/25 GHz frequency intervals. The output spectrum of optical signal is shown after a 40 km SSMF line

The fundamental limitation in the high-speed (over 2.5 Gbit/s per channel) systems is set by the total dispersion in the fiber optical transmission (FOTS) lines. Without managing the dispersion, the FOTS operation with a 10 Gbit/s transmission speed per channel is limited to the line length from 40 km to 50 km. Fig. 10 shows the eye diagrams and output signal spectra in HDWDM communication systems with 10 Gbit/s transmission speed for different frequency intervals.

From Fig. 10 it is seen that a WDM communication system with a 10 Gbit/s transmission speed per channel and a frequency interval of 50 GHz could be optimized. In the four-channel case a decrease in the frequency interval to 31.25 GHz ensures a satisfactory BER value.

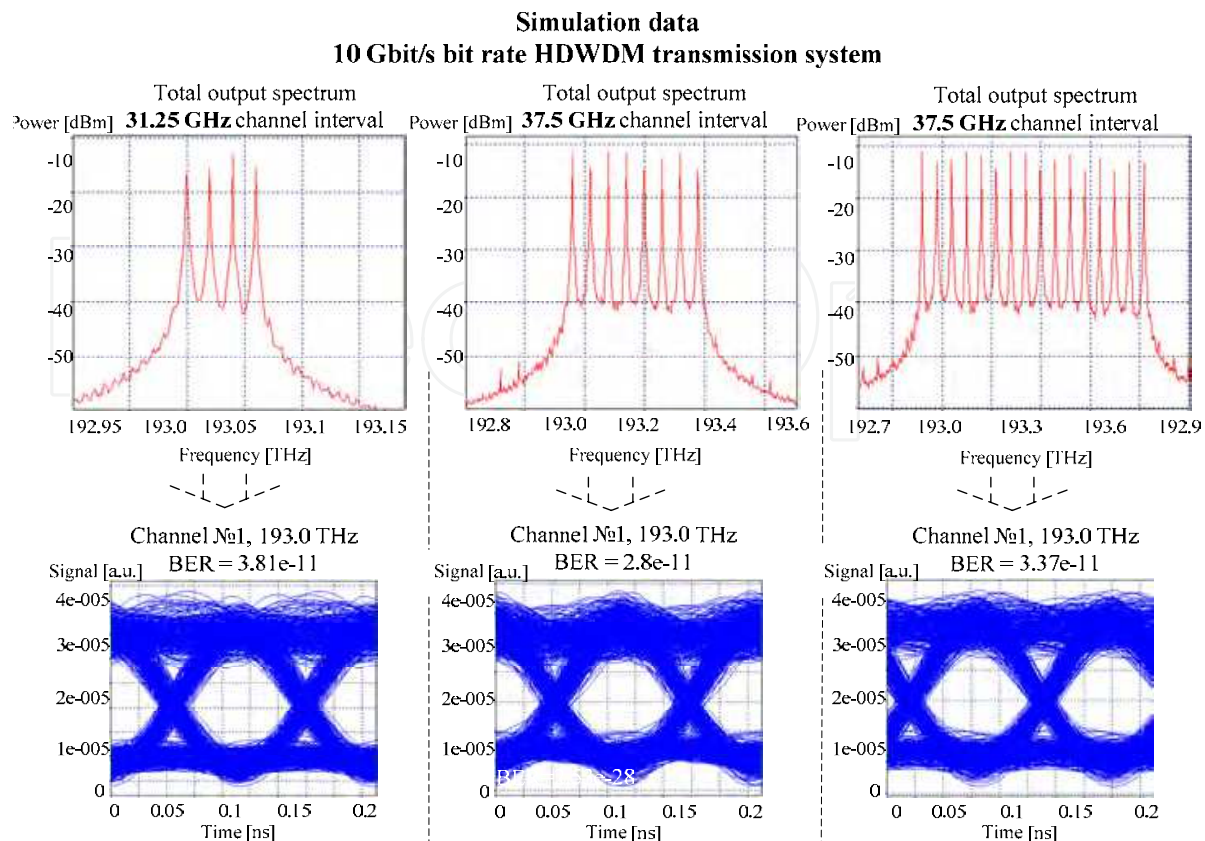

Fig. 10. 10 Gbit/s HDWDM communication system with 4/8/16 channels and 31.25/37.5/37.5 GHz frequency intervals. The output spectrum of the optical signal and eye diagrams are shown for the end of a 40 km SMF line.

With the number of channels increasing this value also increases. As a result, the optimal channel spacing in WDM systems with a 10 Gbit/s transmission speed per channel is 37.5 GHz; the possibility exists to provide a high-quality transmission of signals over 40 - 50 km (see Fig. 11).

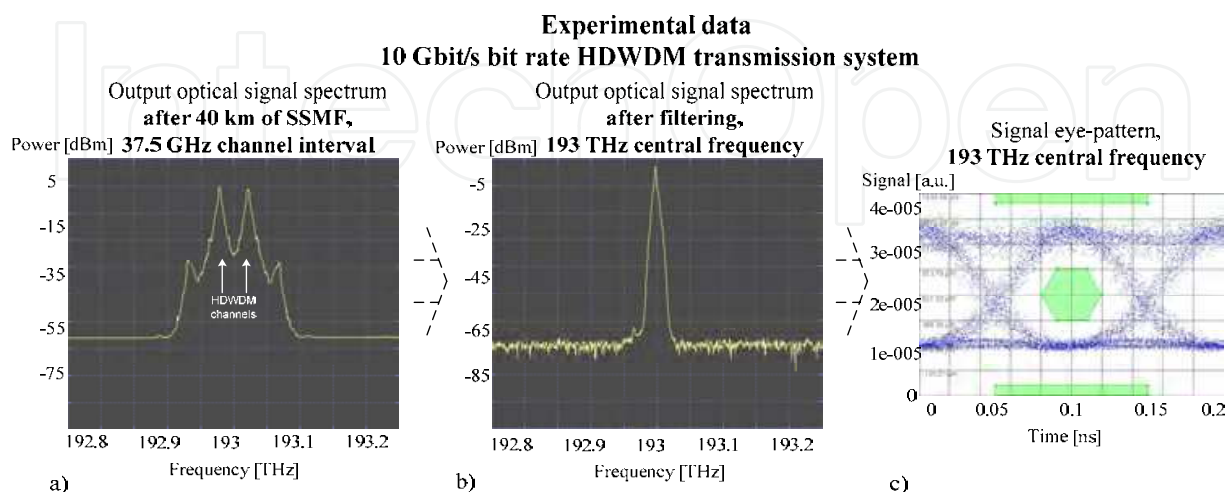

Fig. 11. Output optical signal spectra and eye-patterns with defined masks for 10 Gbit/s system: a) common optical spectra, b) signal optical spectrum after filtering, c) eye-pattern.

In the process of investigation it has been established that the operators of telecommunication networks when using a WDM communication system's facilities are raising its total transmission speed gradually, depending on the requested information volume, adding new channels with different transmission speeds (2.5 Gbit/s or 10 Gbit/s), different coding formats (NRZ, RZ or Duobinary) and variable frequency intervals (12.5 GHz, 25 GHz, 50 GHz, or 100 GHz); all this can result in the spectral overlapping and increased BER of the signal. We therefore have estimated the possibilities of a mixed HDWDM communication system applying different signal coding techniques (NRZ, RZ and Duo) in each channel (see Fig. 12).

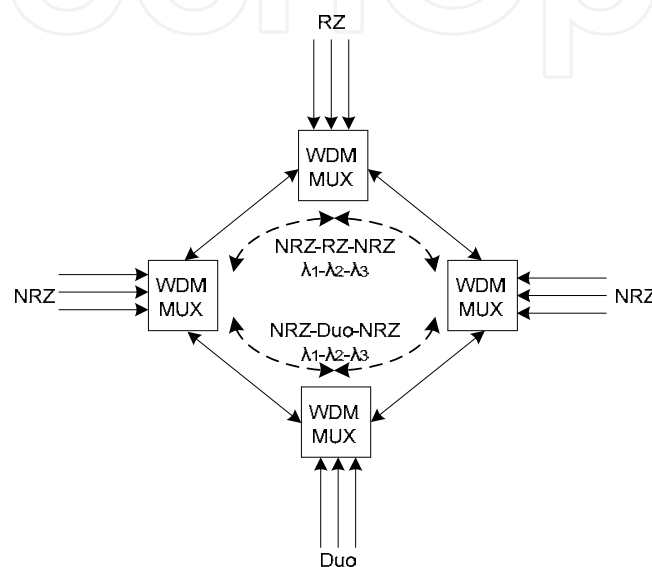

Fig. 12. A mixed scheme of the WDM communication system. The NRZ, RZ and Duobinary (Duo) intensity modulation formats are applied for the 2.5 Gbit/s and 10 Gbit/s signal transmission

The design with a transmitter unit containing three combined channels is the simplest model, in which between two NRZ signals the RZ or Duo signals are located. The NRZ signal format is chosen as a base, since it is the format preferred by the majority of telecommunication operators. Further, the operation of a mixed HDWDM communication system was subjected to scrutiny, changing the transmission speed from 2.5 Gbit/s to 10 Gbit/s per channel and the channel interval in a wide range – from 12.5 GHz to 100 GHz. Fig. 13 shows the potential of NRZ-RZ-NRZ mixed HDWDM systems (with only successful signal transmission displayed). The transmission speed used for each signal is 2.5 Gbit/s. In such a case the minimum channel interval is to be equal to or greater than 25 GHz. Only under such conditions a successful realization (i.e. with $BER < 10^{-9}$) is possible for a mixed HDWDM communication system with NRZ-RZ-NRZ signals.

When creating a mixed HDWDM communication system based on NRZ-RZ-NRZ formats of signals with a 10 Gbit/s transmission speed per channel it is possible to multiplex the signals with a 50 GHz frequency interval, since the quality of the output signal meets in this case the BER standard (see Fig. 14). Reducing the channel interval still further would impair the signal's characteristics. This means that the least frequency interval for the mixed NRZ-RZ-NRZ HDWDM communication system under consideration is 50 GHz.

2.5 Gbit/s bit rate NRZ-RZ-NRZ mixed HDWDM system

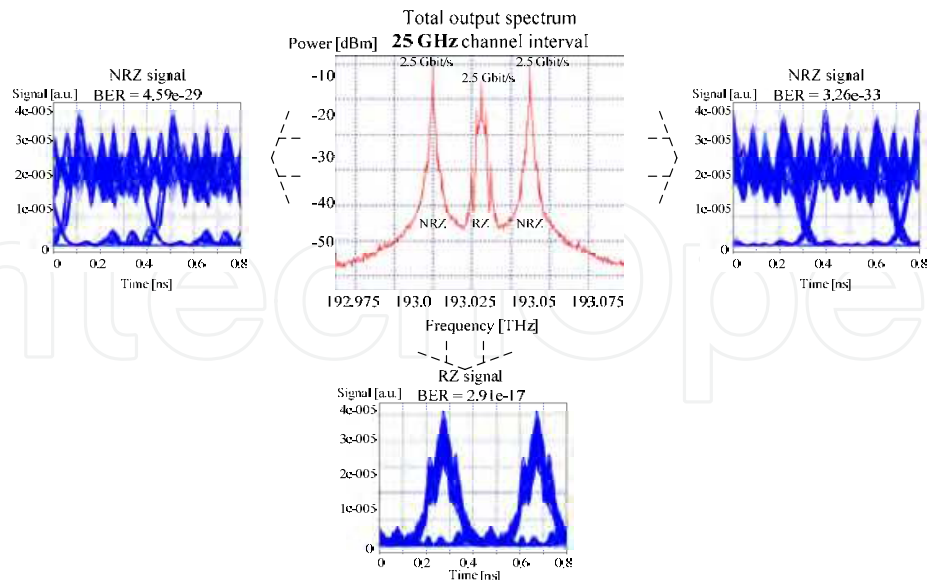

Fig. 13. A 2.5 Gbit/s mixed HDWDM communication system with NRZ-RZ-NRZ signals and a 25 GHz frequency interval. The output spectrum of the optical signal and the eye diagrams of the received electrical signal are shown

This done, the operation of a mixed HDWDM communication system with NRZ-Duobinary-NRZ signal formats was studied for a 2.5 Gbit/s transmission speed per channel. The conclusion was that it is possible to compact the signals with a 12.5 GHz frequency interval and a proper BER ($< 10^{-9}$); this is two times more compact than in the NRZ-RZ-NRZ case, which would provide a highly efficient use of the spectrum (see Fig. 15).

10 Gbit/s bit rate NRZ-RZ-NRZ mixed HDWDM system

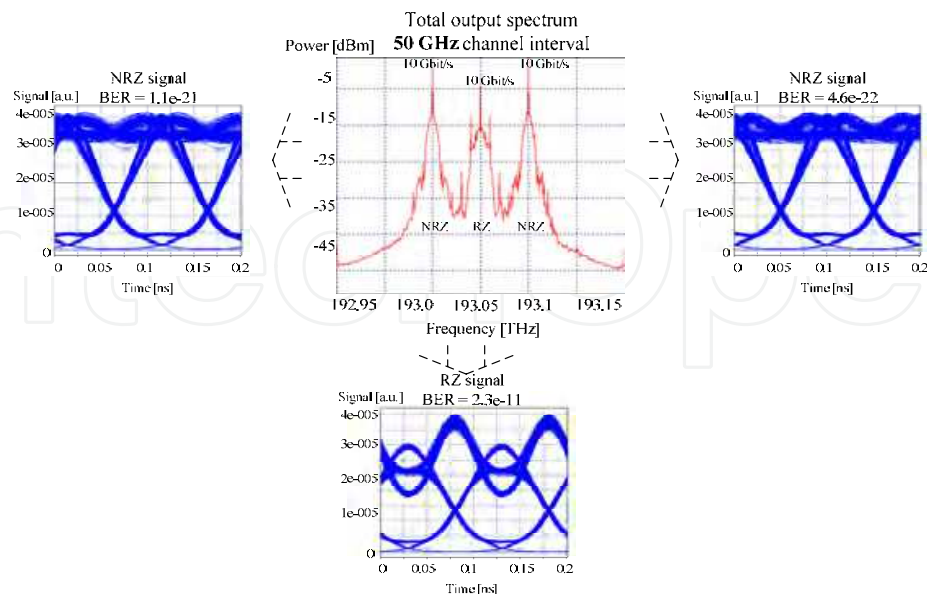
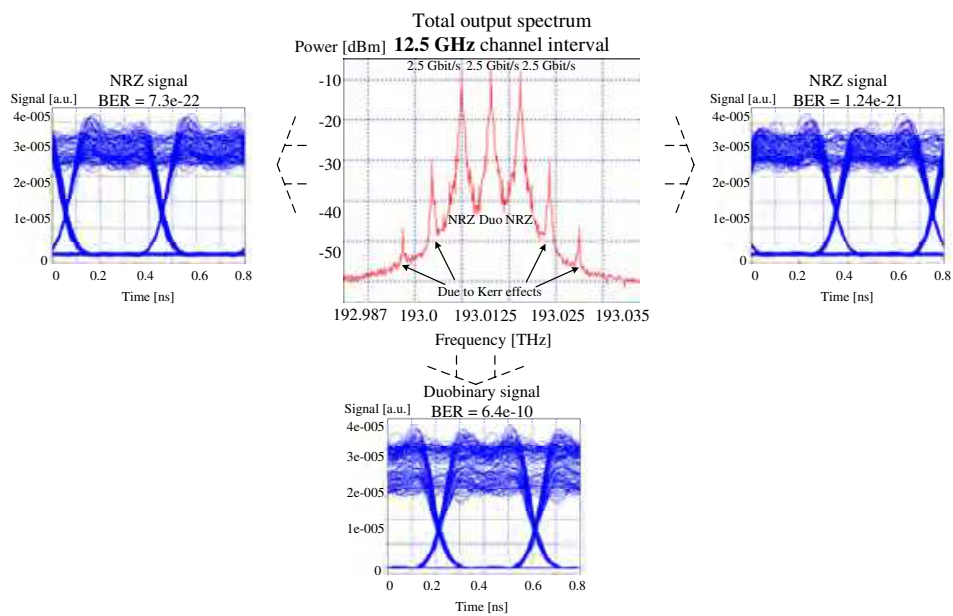

Fig. 14. A 10 Gbit/s mixed HDWDM communication system with NRZ-RZ-NRZ signals and a 50 GHz frequency interval. The output spectrum of the optical signal and the eye diagrams of the received electrical signal are shown.

IntechOpen

2.5 Gbit/s bit rate NRZ-Duobinary-NRZ mixed HDWDM system



IntechOpen

Fig. 15. A 2.5 Gbit/s mixed HDWDM communication system with NRZ-Duobinary-NRZ signals and a 12.5 GHz frequency interval. The output spectrum of the optical signal and the eye diagrams of the received electrical signal are shown.

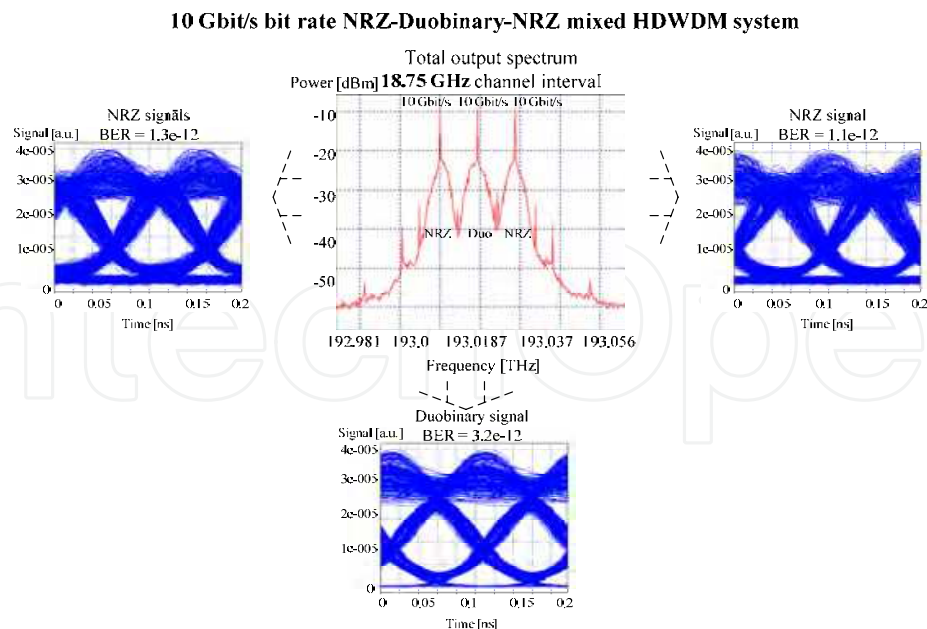

Fig. 16. A 10 Gbit/s mixed HDWDM communication system with NRZ-Duobinary-NRZ signals and an 18.75 GHz frequency interval. The output spectrum of the optical signal and the eye diagrams of the received electrical signal are shown

At the same time, the increase in the transmission speed from 2.5 Gbit/s to 10 Gbit/s in a mixed NRZ-Duo-NRZ HDWDM communication system leads to frequency interval rising up to 18.75 GHz, which, as compared with the results for a NRZ-RZ-NRZ system provides a highly efficient exploitation of the spectrum (see Fig. 16).

6. Conclusions

Our results have proved once more that HDWDM is a powerful technique for increasing the capacity of fiber optics transmission systems. It may be crucial for enabling technology of ultra-high capacity on-chip optical interconnects, as well as chip-to-chip optical interconnects in massively parallel different optical systems. It has been shown that the BER and eye-diagram technique is a good means for evaluating the system performance that allows HDWDM system to be optimized for different parameters.

In contrast to the conventional high speed approach of increasing WDM transmission capacity, we have demonstrated the minimal allowed channel spacing in HDWDM systems, and provided we are able to provide recommendations for future HDWDM solutions.

In the measurements, different optical filter FWHM values (from 0.15 nm to 0.7 nm) were used. The best results were obtained for 0.15 nm, when the eye pattern was opened wider. For evaluation of the signal quality a visual method was employed, in which the eye pattern was evaluated visually in the electric signal analyser varying the quasi-rectangular optical filter FWHM value.

At reducing the channel interval to 18.75 GHz the Kerr effects (self-phase modulation, cross-phase modulation, and four-wave mixing) degrades the 2.5 Gbit/s HDWDM system. The signal eye-pattern overlaps with the mask, which means that the signal quality does not

ensure in this case the BER value of 10^{-9} . From the measurement results it follows that the 25 GHz channel interval ensures a good signal quality and that the signal eye-pattern does not overlap with the mask.

At 10 Gbit/s HDWDM transmission the channel interval should be 37.5 GHz to ensure the signal quality with the BER value of 10^{-9} , which fits well the previous simulation results.

It is established that the operators of telecommunication networks, when creating the HDWDM communication systems, raise the total transmission speed step-by-step in response to the increased request for the data volume. As a result, a mixed HDWDM system is formed, with different transmission speeds (2.5 Gbit/s or 10 Gbit/s), coding formats (NRZ, RZ or Duobinary) and frequency intervals (12.5 GHz, 25 GHz, 50 GHz, 100 GHz). Therefore, in order to ensure stable functioning (i.e. $BER < 10^{-9}$ for each signal) of a mixed HDWDM system the channel interval should exceed 25 GHz at a 2.5 Gbit/s transmission speed per channel. In turn, for stable operation of a mixed 10 Gbit/s WDM system the frequency interval should be raised to 50 GHz.

The Duobinary technique for signal coding ensures a better protection of the transmitted signals against Kerr effects as compared with the RZ coding. This allows a highly compact NRZ-Duobinary-NRZ system to be formed with the 12.5 GHz frequency interval and 2.5 Gbit/s transmission speed per channel. In turn, in the case of a 10 Gbit/s transmission speed per channel it is possible to use an 18.75 GHz frequency interval.

7. References

- Abbou, F., Chuah, T., Hiew, C. and Abid, A., (2008), Comparison of RZ-OOK and RZ-DPSK in Dense OTDM-WDM Systems Using Q Factor Models, *Journal of Russian Laser Research*, Vol.29, pp. 133-141.
- Agrawal, G.P. (2001), *Nonlinear Fiber Optics*, 3rd edition, Academic Press, California.
- Azadeh, M. (2009), *Fiber Optics Engineering*. Springer, New York.
- Belai, O. V., Shapiro, D. A. and Shapiro, E. G., (2006), Optimisation of a High-Bit-Rate Optical Communication Link with a Non ideal Quasi-Rectangular Filter. *Quantum Electronics*. Vol.36(9), pp. 879-882.
- Bhamber, R., Turitsyn, K., Mezentsev, V., (2007), Effect of carrier reshaping and narrow MUX-DEMUX filtering in 0.8 bit/s/Hz WDM RZ-DPSK transmission, *Optical Quantum Electronics*, Vol.39. pp. 687-692.
- Bierlaire, M., Bolduc, D. and McFadden, D., (2007), Characteristics of generalized extreme value distributions. *Technical report*.
- Binh, Le Nguyen, (2008), *Photonic Signal Processing: Techniques and Applications*, CRC Press, Boca Raton.
- Binh, Le Nguyen, (2009), *Digital Optical Communications*, CRC Press, Boca Raton.
- Bobrovs, V., Ivanovs, G., (2008), Comparison of different modulation formats and their compatibility with WDM transmission system, *Latvian Journal of Physics and Technical Sciences*, Vol.2, pp. 6-21.
- Bobrovs, V., Ivanovs, G., (2009) Investigation of Minimal Channel Spacing in HDWDM Systems, *Electronics and Electrical Engineering*, Vol.4(92), pp. 53-56.

- Bobrovs., V., Ozolins., O., Ivanovs., G., (2010), Investigation into the potentialities of quasi-rectangular optical filters in HDWDM systems, *Latvian Journal of Physics and Technical Sciences*, Vol.1, pp. 13-25.
- Cisco Systems, (2008), Cisco Visual Networking Index – Forecast and Methodology 2007-2012., *White paper*, pp. 1-15.
- Chen, L., Zhang, Z. and Bao, X., (2006), Polarization dependent loss vector measurement in a system with polarization mode dispersion, *Optical Fiber Technology*, Vol.12, pp. 251-254.
- Funabashi, M., Hiraiwa, K., Koizumi, S., Yamanaka, N., and Kusakawa, A., (2001), Low operating current 40 mW PM fiber coupled DFB laser modules for externally modulated 1550 nm WDM sources, *European Conference on Optical Communication*, 2(Tu.B.1.3), pp. 122-123.
- Ivanovs., G., Bobrovs., V., Ozolins, O. and Porins., J., (2010), Realization of HDWDM transmission system, *International Journal of the Physical Sciences*, Vol.5(5), pp. 452-458.
- Jacobsen., G., (1994) *Noise in digital optical transmission systems*, Artech House, Boston.
- Kaminow, I., Tingye, L. and Willner., A., (2008), *Optical Fiber Telecommunications V A Components and Subsystems*, Elsevier Academic Press, Burlington & San Diego.
- Kaminow, I., Tingye, L., and Willner., A., (2008), *Optical Fiber Telecommunications V B Systems and Networks*, Elsevier Academic Press, Burlington & San Diego.
- Kashyap, R., (2010), *Fiber Bragg gratings*: Academic Press, London.
- Kotz, S. and Nadarajah, S., (2000), *Extreme value distributions: theory and applications*. ICP Imperial College Press, London.
- Markose, S. and Alentorn, A., (2007), *The generalized extreme value distribution, implied tail index and option pricing*, University of Essex, Colchester.
- McGloin, D. and Reid, J.P., (2010), 40 Years of Optical Manipulation, *Optics and Photonics News*, Vol. 20, Iss. 3, pp. 20-26.
- Ozoliņš, O., & Ivanovs, G., (2009), Realization of Optimal FBG Band-Pass Filters for High Speed HDWDM, *Electronics and Electrical Engineering*, 4(92), pp. 41-44.
- Ozoliņš, O., Bobrovs, V., Ivanovs, G. (2011), DWDM Transmission Based on the Thin-Film Filter Technology, *Latvian Journal of Physics and Technical Sciences*, Vol.3, pp. 55.-65.
- Pan, Z., Yu, C. and Willner, A. E., (2010), Optical performance monitoring for the next generation optical communication networks, *Optical Fiber Technology*, Vol.16 (1), pp. 20-45.
- Pfennigbauer, M., and Winzer, P.J., (2006), Choice of MUX/DEMUX filters characteristics for NRZ, RZ, and CSRZ DWDM systems, *Lightwave Technology*, 24(4), pp. 1689-1696.
- Rongqing, H. and O'Sullivan, M., (2009), *Fiber Optics Measurement Techniques*. Elsevier Academic Press, Burlington & San Diego.
- Szodenyi, A., (2004), Optical filter type influence on transparent WDM network's size, *Hiradastechnika*, Vol.12, pp. 55-58.
- Thyagarajan, K. and Ghatak, A., (2007), *Fiber Optics Essentials*, IEEE press: Willey Interscience.

Venghaus, H., (2006), *Wavelength Filters in Fibre Optics*, Springer, Berlin.

Voges, E. and Petermann, K., (2002), *Optische Kommunikationstechnik - Handbuch für Wissenschaft un Industrie* Springer-Verlag, Berlin.

IntechOpen

IntechOpen

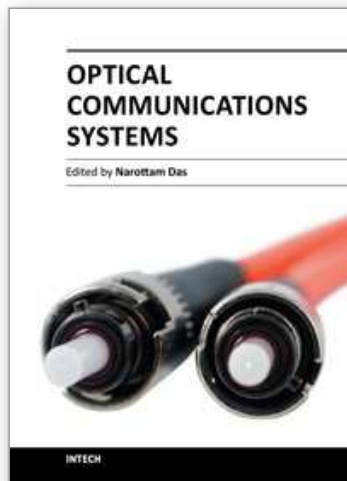

Optical Communications Systems

Edited by Dr. Narottam Das

ISBN 978-953-51-0170-3

Hard cover, 262 pages

Publisher InTech

Published online 07, March, 2012

Published in print edition March, 2012

Optical communications systems are very important for all types of telecommunications and networks. They consist of a transmitter that encodes a message into an optical signal, a channel that carries the signal to its destination, and a receiver that reproduces the message from the received optical signal. This book presents up to date results on communication systems, along with the explanations of their relevance, from leading researchers in this field. Its chapters cover general concepts of optical and wireless optical communication systems, optical amplifiers and networks, optical multiplexing and demultiplexing for optical communication systems, and network traffic engineering. Recently, wavelength conversion and other enhanced signal processing functions are also considered in depth for optical communications systems. The researcher has also concentrated on wavelength conversion, switching, demultiplexing in the time domain and other enhanced functions for optical communications systems. This book is targeted at research, development and design engineers from the teams in manufacturing industry; academia and telecommunications service operators/providers.

How to reference

In order to correctly reference this scholarly work, feel free to copy and paste the following:

Jurgis Porins, Vjaceslavs Bobrovs and Girts Ivanovs (2012). Realization of HDWDM Transmission System with the Minimum Allowable Channel Interval, *Optical Communications Systems*, Dr. Narottam Das (Ed.), ISBN: 978-953-51-0170-3, InTech, Available from: <http://www.intechopen.com/books/optical-communications-systems/realization-of-hdwdm-transmission-system-with-the-minimum-allowable-channel-interval>

INTECH
open science | open minds

InTech Europe

University Campus STeP Ri
Slavka Krautzeka 83/A
51000 Rijeka, Croatia
Phone: +385 (51) 770 447
Fax: +385 (51) 686 166
www.intechopen.com

InTech China

Unit 405, Office Block, Hotel Equatorial Shanghai
No.65, Yan An Road (West), Shanghai, 200040, China
中国上海市延安西路65号上海国际贵都大饭店办公楼405单元
Phone: +86-21-62489820
Fax: +86-21-62489821

© 2012 The Author(s). Licensee IntechOpen. This is an open access article distributed under the terms of the [Creative Commons Attribution 3.0 License](#), which permits unrestricted use, distribution, and reproduction in any medium, provided the original work is properly cited.

IntechOpen

IntechOpen