

We are IntechOpen, the world's leading publisher of Open Access books Built by scientists, for scientists

5,400

Open access books available

133,000

International authors and editors

165M

Downloads

Our authors are among the

154

Countries delivered to

TOP 1%

most cited scientists

12.2%

Contributors from top 500 universities



WEB OF SCIENCE™

Selection of our books indexed in the Book Citation Index
in Web of Science™ Core Collection (BKCI)

Interested in publishing with us?
Contact book.department@intechopen.com

Numbers displayed above are based on latest data collected.
For more information visit www.intechopen.com



Atopic Dermatitis and Skin Fungal Microorganisms

Takashi Sugita¹, Enshi Zhang³, Takafumi Tanaka¹, Mami Tajima³,
Ryoji Tsuboi³, Yoshio Ishibashi², Akemi Nishikawa²

¹Department of Microbiology, Meiji Pharmaceutical University, Kiyose, Tokyo

²Department of Immunobiology, Meiji Pharmaceutical University, Kiyose, Tokyo

³Department of Dermatology, Tokyo Medical University, Shinjuku, Tokyo
Japan

1. Introduction

A wide variety of bacteria and fungi are found on the human skin. Although some skin microorganisms produce antibacterial peptides that inhibit invasion by pathogens or promote the integrity of cutaneous defenses by eliciting host immune responses, the normal microbiome can also cause several skin diseases.

Atopic dermatitis (AD) is a chronic disease that causes pruritus and involves cycles of remission and deterioration. AD is the result of dry hypersensitive skin. When the skin is dry, the protective barrier function of the cutaneous surface horny layer is compromised, and the skin readily develops dermatitis in response to various external stimuli, including skin microorganisms. Serum from almost all AD patients contains IgE antibodies against some skin microorganisms. For example, staphylococcal superantigen-specific IgE is present in the serum of AD patients, but not in the serum of healthy individuals. Normally, the weakly acidic condition of healthy skin prevents colonization by *Staphylococcus aureus*. However, in patients with AD, the skin pH is shifted toward neutrality, allowing *S. aureus* to grow and exacerbate AD.

In the cutaneous fungal microbiome, lipophilic yeasts of the genus *Malassezia* are the predominant species on human skin. As *Malassezia* species require lipids for growth, they preferentially colonize sebum-rich areas such as the head, face, and neck, as opposed to the limbs or trunk. Specific IgE antibody against *Malassezia* species is found in the serum of AD patients. Antifungal therapy improves the symptoms of AD by decreasing the level of *Malassezia* colonization, suggesting that these microorganisms also exacerbate AD. *Malassezia* species, unlike *S. aureus*, colonize both AD patients and healthy subjects. Currently, the genus *Malassezia* consists of 14 species. Of these, *M. globosa* and *M. restricta* have been detected in almost all AD patients, suggesting that these two *Malassezia* species play a significant role in AD. The level of specific IgE antibody against both species is greater than that against other *Malassezia* species.

This chapter discusses cutaneous fungi as an exacerbating factor in AD, focusing on:

- the fungal microbiome in patients with AD.
- immunological aspects of fungal colonization, and
- treatment with antifungal agents.

2. The fungal microbiome in patients with atopic dermatitis

2.1 Colonization by the fungus *Malassezia* in patients with atopic dermatitis

The lipophilic yeast *Malassezia* is the predominant fungus on human skin. Morphologically, these microorganisms are ovoid, elongate, and cylindrical (Fig. 1). Their genome is smaller than that of other fungi (Xu *et al.* 2007). As *Malassezia* species require lipids for growth, they preferentially colonize sebum-rich areas such as the head, face, or neck, rather than the limbs or trunk. Specific IgE antibodies against *Malassezia* are present in the serum of patients with AD, and antifungal therapy can improve the symptoms of AD by decreasing the degree of colonization by *Malassezia*; thus, this fungus is believed to be an exacerbating factor in AD (more details are provided in a later chapter). In contrast to *S. aureus*, *Malassezia* species colonize both AD patients and healthy individuals. In addition to AD, *Malassezia* species are responsible for seborrheic dermatitis, folliculitis, and pityriasis versicolor (Gupta *et al.* 2004; Ashbee 2007). Currently, 14 species are recognized within the genus *Malassezia* (Table 1), and five of these (*M. caprae*, *M. cuniculi*, *M. equina*, *M. nana*, and *M. pachydermatis*) show affinity for nonhuman animals.

Host	Species	Species implicated in skin disease in human
Human associated species	<i>Malassezia dermatis</i>	AD
	<i>Malassezia furfur</i>	SI
	<i>Malassezia globosa</i>	AD, SD, PV
	<i>Malassezia japonica</i>	
	<i>Malassezia obtusa</i>	
	<i>Malassezia slooffiae</i>	
	<i>Malassezia sympodialis</i>	AD, SD
	<i>Malassezia restricta</i>	AD, SD, PV
	<i>Malassezia yamatoensis</i>	
Nonhuman animal associated species	<i>Malassezia caprae</i>	
	<i>Malassezia cuniculi</i>	
	<i>Malassezia equina</i>	
	<i>Malassezia nana</i>	
	<i>Malassezia pachydermatis</i>	

AD, atopic dermatitis; SD, seborrheic dermatitis; SI, systemic infection; PV, pityriasis versicolor

Table 1. Currently accepted *Malassezia* species

A number of epidemiological studies have been conducted during the past decade to elucidate the role of *Malassezia* as an exacerbating factor in AD. The first was carried out by Nakabayashi *et al.* (2000) in Japan and detected *M. furfur*, *M. globosa*, *M. sympodialis*, and *M.*

slooffiae in 21.4, 14.3, 7.1, and 3.6% of samples from Japanese AD patients, respectively. A study conducted in Sweden in 2005 produced similar results (Sandström *et al.* 2005). However, a Canadian study by Gupta *et al.* (2001) reported the predominant species to be *M. sympodialis*, which was detected in 51.3% of the samples from AD patients. All of these studies were performed using culture-dependent methods. In all cases, scale samples were collected by an appropriate method, e.g., swabbing, scratching, or stripping, and were incubated in medium containing several types of fatty acids. The recovered microorganisms were identified based on biochemical or physiological characteristics, including assimilation of Tween compounds and esculin, catalase reaction, and maximum growth temperature (Guého-Kellermann 2010; Kaneko *et al.* 2007). However, culture-dependent methods may not provide accurate and reliable results for *Malassezia*. The efficiency of culturing *Malassezia* strains depends on the isolation medium used, and the growth of some species, such as *M. obtusa* and *M. restricta*, is slower than that of others.

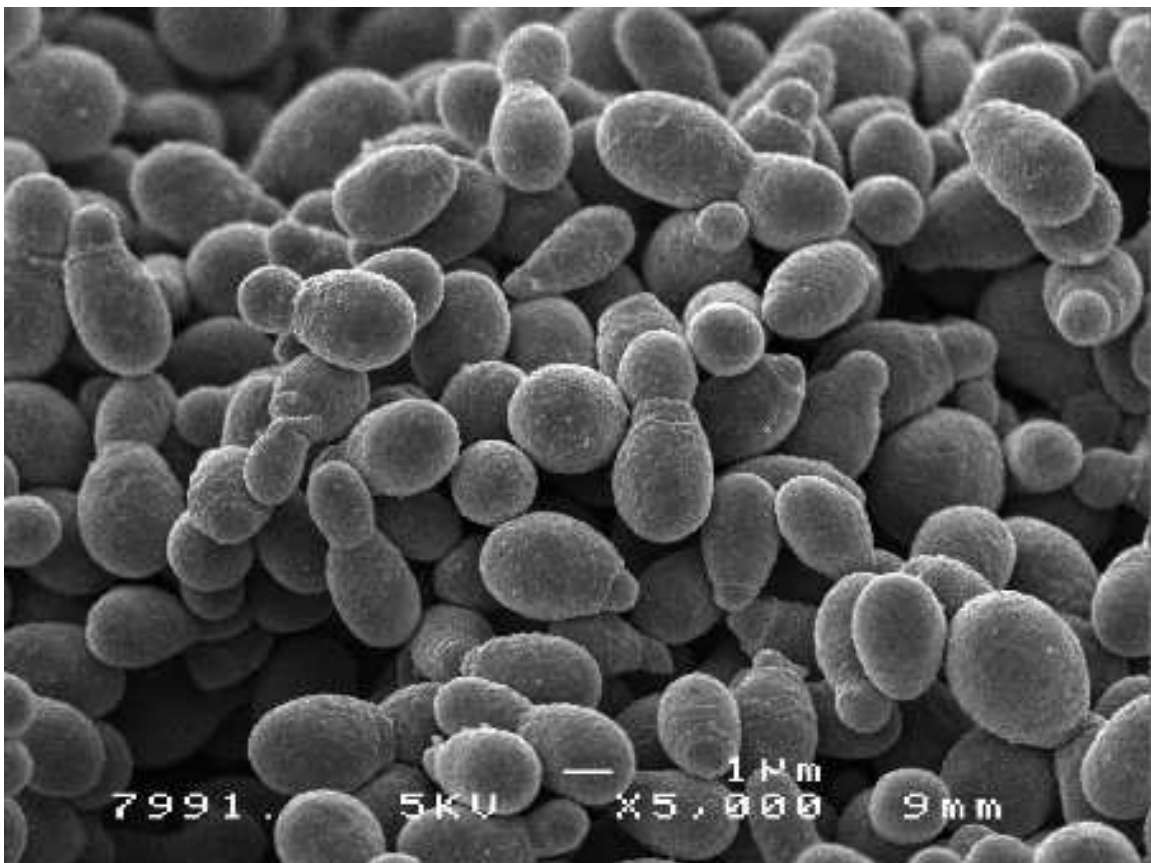

Magnification is x5,000.

Fig. 1. Morphology of *Malassezia restricta* by scanning electron microscope

To overcome the difficulties of culture-dependent methods, including scale sampling methods, culturing conditions, and isolation techniques, Sugita *et al.* (2001) developed the first molecular analytical method for *Malassezia*. For this method, scale samples are collected by stripping with medical transparent dressing, and skin *Malassezia* DNA is directly extracted from the dressing. The *Malassezia* microbiota is then analyzed by real-time PCR, specific detection by PCR with a species-specific primer, or an rRNA clone method (Sugita *et al.* 2011). Although more expensive than culture-dependent methods, a

molecular-based, non-culture approach appears to be the most reliable and appropriate for analysis of the skin *Malassezia* microbiota (Sugita *et al.* 2001; Morishita *et al.* 2006; Takahata *et al.* 2007a, 2007b; Tajima *et al.* 2008; Amaya *et al.* 2007). In all scale samples from AD patients, both *M. globosa* and *M. restricta* were detected by the molecular-based method, with the level of colonization by *M. restricta* being approximately 1.6 times that of *M. globosa* (Sugita *et al.* 2006a). *Malassezia sympodialis* was the second most predominant species (detected in 58% of the cases), and *M. dermatitis*, *M. furfur*, *M. obtusa*, and *M. slooffiae* were detected in less than 30% of the cases (Fig. 2). These results suggest that both *M. globosa* and *M. restricta* may significantly exacerbate AD.

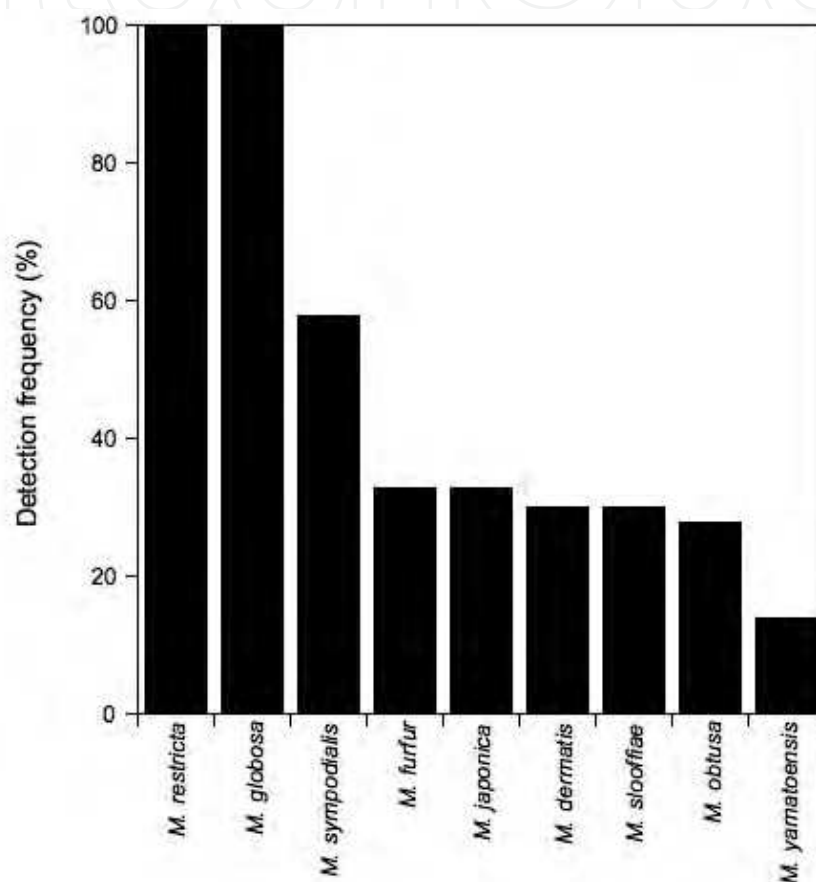

Malassezia DNA was detected by nested PCR assay with species-specific primers

Fig. 2. Colonization frequency of *Malassezia* in the scale of patient with atopic dermatitis

Given that *M. globosa* and *M. restricta* commonly colonize both AD patients and healthy individuals, specific genotypes of these microorganisms may play a role in AD (Sugita *et al.* 2003, 2004, 2010). The fungal rRNA gene consists of four subunits: 5S, 5.8S, 18S (small), and 26S (large). Located between the subunits are an internal transcribed spacer (ITS) and an intergenic spacer (IGS). In *M. globosa*, the IGS is 444 to 454 bp long and has four short sequence repeats (SSRs), $(CT)_n$, $(CT)_n$, $(CT)_n$, and $(GT)_n$ which occur at positions 29–49, 278–291, 380–485, and 242–267, respectively, in the IGS sequence of *M. globosa* strain CBS 7996. Alignments of IGS 1 sequences of two *M. globosa* strains are shown in Fig. 3. The number of $(CT)_n$ SSRs in the IGS 1 region is more variable in samples from healthy individuals than in those from AD patients. In samples from AD patients, the number of sequence repeats in the IGS 1 region

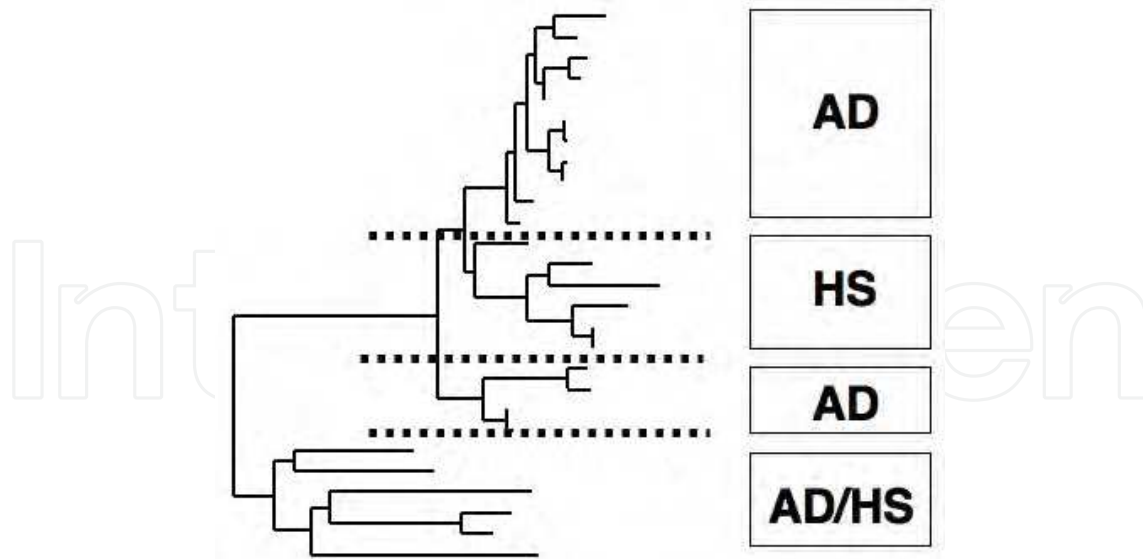

AD, patients with atopic dermatitis; HS, healthy subjects.

Fig. 4. Phylogenetic tree of *M. globosa* colonizing the skin surface of AD patients and healthy subjects based on DNA sequences of the IGS 1 region

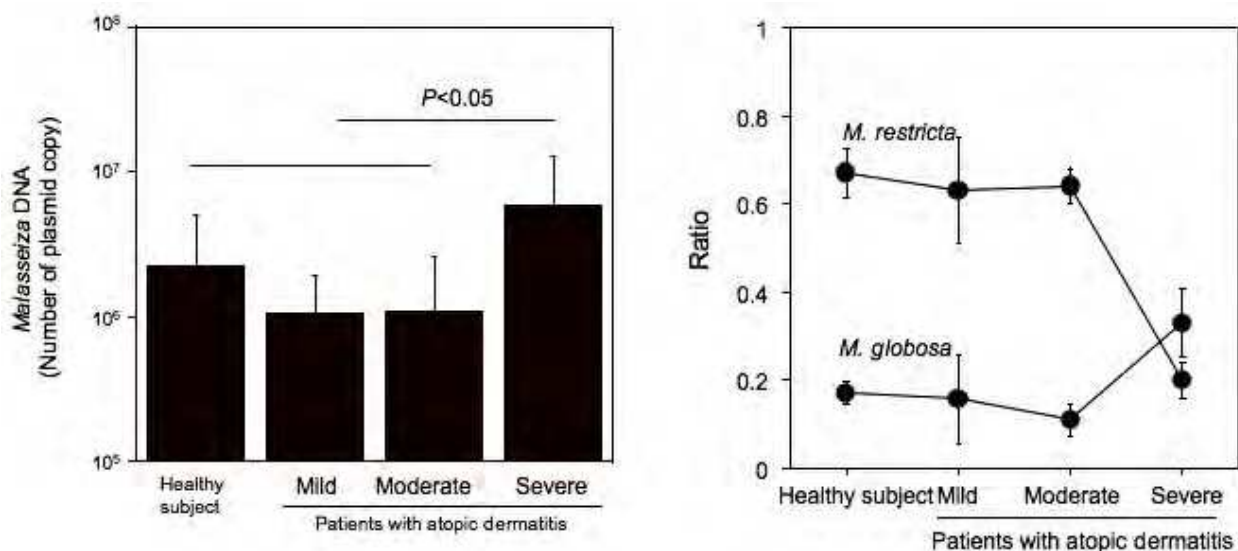
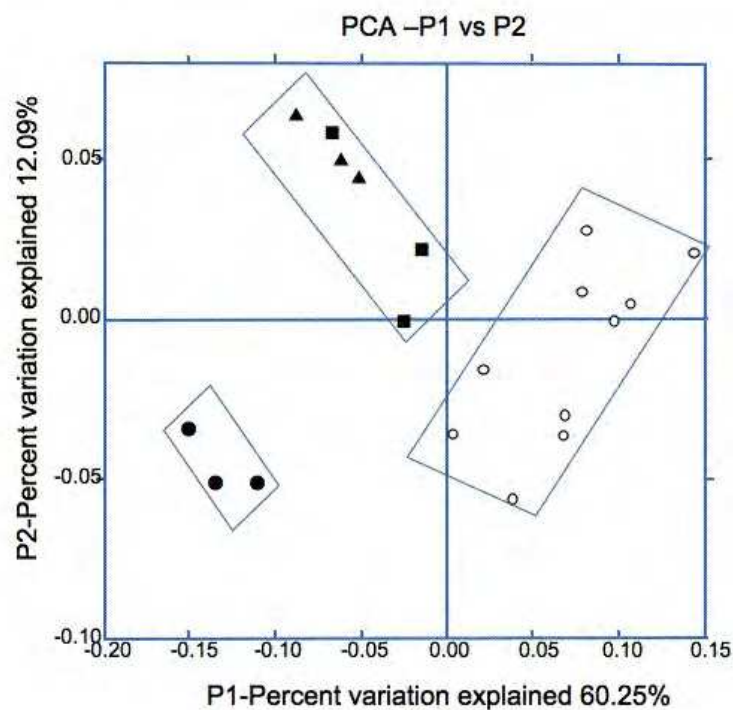

Fig. 5. Level of *Malassezia* colonization in patients with atopic dermatitis and in healthy individuals (A). Ratio of the two major *Malassezia* species, *M. globosa* and *M. restricta*, in patients with atopic dermatitis and in healthy individuals (B)

In a comprehensive analysis using an rRNA gene clone library method, Zhang *et al.* (2011) found that not only *Malassezia* but also the overall fungal microbiota differed according to AD severity. Their analysis of 3,647 clones of the fungal rRNA gene in scale samples from nine AD patients (3 mild, 3 moderate, and 3 severe cases) and 10 healthy individuals revealed 58 fungi and seven unknown phylotypes. *Malassezia* predominated, representing 63–86% of the clones identified from each subject. The number of clones had no noticeable relationship to disease severity, with the mild, moderate, and severe cases accounting for 67.8 ± 2.2 , 70.7 ± 2.8 , and $64.9 \pm 1.8\%$ of the clones, respectively. The study also confirmed

that both *M. globosa* and *M. restricta* were the predominant species regardless of disease severity, with a detection rate of 57.5–70.4% in all clones analyzed. However, the ratio of *M. globosa* to *M. restricta* in the mild and moderate cases (*M. restricta*/*M. globosa*: 3.1–3.4 in mild and 2.1–4.1 in moderate cases) differed from that in the severe cases (1.1–1.4). Figure 6 shows the phylogenetic distribution between AD patients and healthy individuals, based on principal coordinates analysis. Patients with mild or moderate symptoms of AD constituted a single cluster, and patients with severe disease formed a separate cluster. Similarly, the healthy individuals clustered independently.



Closed triangle, patients with mild symptoms; closed square, patient with moderate symptoms; closed circle, patients with severe symptoms; open circle, healthy individuals

Fig. 6. Principal coordinates analysis (PCA) score plot of the sequence profiles for the predominant skin fungi

Differences in microbiota are thought to be attributable to differences in the physiological condition of the skin between patients with AD and healthy subjects. For example, skin pH may change skin microbiota (Seidenari and Giusti, 1995). *Staphylococcus epidermidis* is present in the skin microbiota of healthy individuals, whereas *S. aureus* is not. The level of colonization by *S. aureus* increases according to the severity of AD. In contrast, the level of colonization by *S. epidermidis* decreases gradually with increasing AD severity. Healthy skin is weakly acidic, whereas the skin pH in patients with AD is near neutral, which facilitates invasion by exogenous microorganisms, including *S. aureus* (Higaki *et al.* 1999; Hoeger *et al.* 1992). The expression levels of antimicrobial peptides may also affect the fungal microbiota (Howell 2007). The antimicrobial peptides known as defensins and cathelicidins are deficient in the skin of AD patients, and thus the fungal microbiota should be different between AD patients and healthy individuals. Sebum is a growth medium for skin microorganisms and consists of squalene, cholesterol esters, wax esters, triglycerides, free fatty acids, cholesterol, ceramides, cholesterol sulfate, and phospholipids. Of these, the

proportion of ceramide 1, which is a carrier of linoleate and responsible for the water-barrier function of the skin, is significantly lower in patients with AD (Yamamoto *et al.* 1991). Therefore, the composition of sebum may also affect the fungal microbiota.

3. Immunological aspects of *Malassezia* colonization

3.1 *Malassezia* specific IgE antibody

Specific IgE antibodies against skin *Malassezia* are present in the serum of AD patients whereas no anti-*Malassezia* specific IgE antibody is found in the serum of healthy individuals (Sugita *et al.* 2001). Many studies have reported on anti-*Malassezia* specific IgE antibodies in AD patients (Zargari *et al.* 2003; Kato *et al.* 2006). Using an enzyme-linked immunosorbent assay (ELISA), Kato *et al.* (2006) quantified specific IgE antibodies against soluble proteins of eight *Malassezia* species in mechanically disrupted extracts of serum samples from AD patients. The level of IgE specific for *M. restricta* was greater than that against other *Malassezia* species (*M. dermatis*, *M. furfur*, *M. globosa*, *M. obtusa*, *M. pachydermatis*, *M. slooffiae*, and *M. sympodialis*) (Fig. 7); however, a competitive inhibition ELISA revealed that *M. restricta* contained species-specific as well as shared antigens.

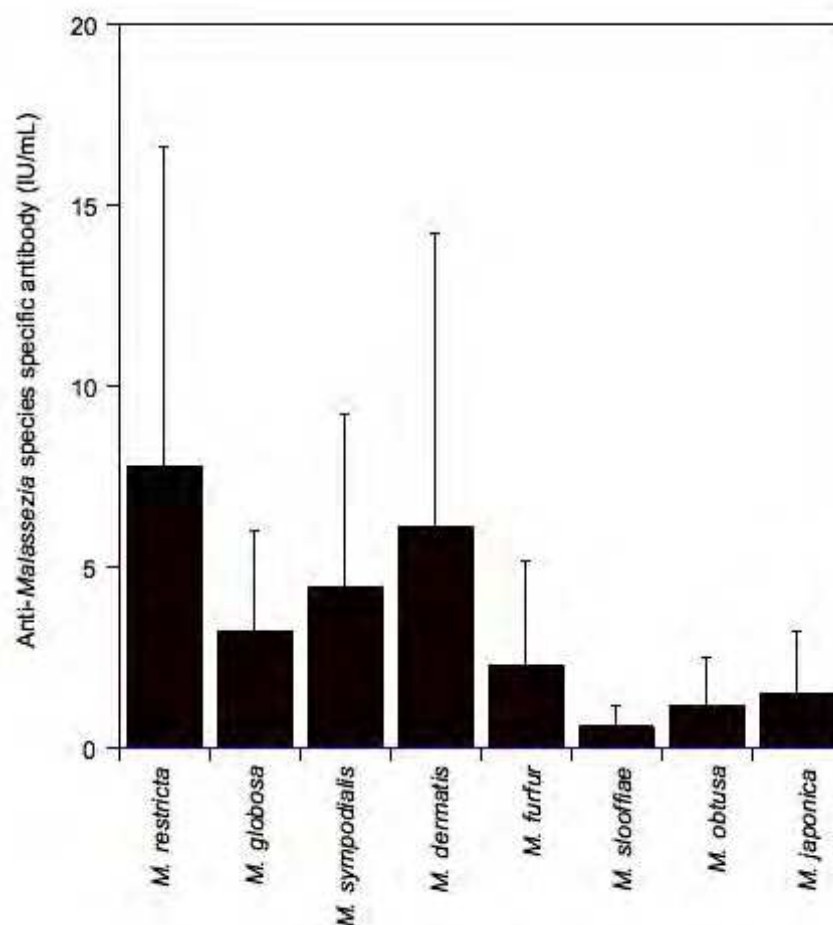

N=24

Fig. 7. The species-specific IgE values of eight *Malassezia* species in sera from patients with atopic dermatitis determined using an ELISA.

The precise mechanisms by which *Malassezia* colonization induces IgE antibody production and the inflammatory cascades that lead to AD remain unclear. The presence of IgE antibodies has been implicated in the production of Th2-type cytokines such as interleukins (IL)-4, -5, -6, -10, and -13, the promotion of IgE antibody production, the differentiation of mast cells, and the growth, migration, and activation of eosinophils (Hamid *et al.* 1994; Leung *et al.* 2000; Chen *et al.* 2004). Keratinocytes, the major cell type in the epidermis, have roles in both skin structural and immunological defense (Esche *et al.* 2004; Albanesi *et al.* 2005). Keratinocytes produce a range of proinflammatory and immune cytokines in response to microorganisms and/or skin damage (Grone *et al.* 2002; Watanabe *et al.* 2001). A recent study has demonstrated that keratinocytes secrete several Th2-type cytokines that are critical in the pathogenesis of AD (Ishibashi *et al.* 2006). Cytokine secretion profiling by antibody array analysis has revealed that *M. globosa* and *M. restricta* induce the secretion of distinct Th2-type cytokines by human keratinocytes: *M. globosa* induces IL-5, IL-10, and IL-13 secretion, while *M. restricta* induces IL-4 secretion. These findings have been confirmed by cDNA microarray analysis showing that *M. globosa* and *M. restricta* upregulate the transcription of the *IL-5* and *IL-4* genes, respectively, in keratinocytes. These observations provide evidence of a possible relationship between *Malassezia* colonization and increased IgE production in AD. It is possible that *M. globosa* and *M. restricta* play a synergistic role in triggering a Th2-shifted humoral immune response in AD. Another important connection between *Malassezia* colonization and AD relates to the increased secretion of granulocyte-macrophage colony-stimulating factor (GM-CSF) and cutaneous T-cell-attracting chemokine (CTACK) by keratinocytes (Ishibashi *et al.* 2006). *Malassezia globosa* is capable of stimulating keratinocytes to secrete GM-CSF, which primarily contributes to the maintenance of the chronic inflammatory process in AD by enhancing the antigen-presenting capacity of Langerhans cells and dendritic cells (Witmer-Pack *et al.* 1987). *Malassezia restricta* induces the secretion of CTACK by keratinocytes. CTACK selectively attracts cutaneous lymphocyte antigen-positive memory T cells to inflammatory sites (Morales *et al.* 1999) and is upregulated in AD patients (Kakinuma *et al.* 2003). The above findings suggest the following possible mechanism by which *Malassezia* species induce an IgE-immune response in patients with AD: a skin barrier dysfunction facilitates skin penetration by colonized *Malassezia*, allowing interactions between *Malassezia* and epidermal Langerhans cells, dendritic cells, and keratinocytes, which subsequently present *Malassezia* antigens, thereby inducing an immune response. This may be augmented by keratinocyte-derived GM-CSF. *Malassezia*-stimulated keratinocytes produce Th2 cytokines, including IL-4 and IL-13, which may in turn stimulate B cells to undergo IgE class switching and produce *Malassezia*-specific IgE. In addition, keratinocyte-derived IL-5 may attract and locally activate eosinophils in lesions of AD.

3.2 *Malassezia* allergens

Many *Malassezia* allergens have been identified, including Mala f2-4, Mala s1, and Mala s5-13. Several researchers have attempted to produce recombinant *Malassezia* allergens (rMala s1 and rMala s5-11) for diagnostic purposes (Schmidt *et al.* 1997; Schmid-Grendelmeier *et al.* 2005, 2006; Limacher *et al.* 2007) (Table 2). Recently, proteomics analysis has been applied to identify major allergens of *M. globosa* (Ishibashi *et al.* 2009). The IgE-reactive component of *M. globosa*, with a molecular mass of 42 kDa and designated as MGp42, has been identified by two-dimensional immunoblotting and partially sequenced by matrix-assisted laser desorption ionization time of flight mass spectrometry with post-source decay of the peptide digest. The

full-length cDNA encoding MGp42 has been cloned and sequenced by the rapid amplification of cDNA ends method. MGp42 exhibits properties similar to those of heat shock protein (hsp) family members, and evidence indicates that MGp42 may be a cleavage product of intact HSP70. However, no IgE cross-reactivity has been observed between MGp42 and recombinant human HSP70, suggesting that the epitopes of MGp42 recognized by serum IgE of AD patients are masked by steric hindrance in the presence of intact HSP70 and become exposed as a result of conformational changes during HSP70 cleavage.

Allergens	Function	Species	Reference
Mala s1	Unknown	<i>M. sympodialis</i>	Schmidt et al. 1997
Mala f2	peroxisomal protein	<i>M. furfur</i>	Yasueda et al. 1998
Mala f3	peroxisomal protein	<i>M. furfur</i>	Yasueda et al. 1998
Mala f4	Malate dehydrogenase	<i>M. furfur</i>	Onishi et al. 1999
Mala s5	peroxisomal protein	<i>M. sympodialis</i>	Hemmann et al. 1997
Mala s6	Cyclophilin	<i>M. sympodialis</i>	Hemmann et al. 1997
Mala s7	Unknown	<i>M. sympodialis</i>	Weichel et al. 2002
Mala s8	Unknown	<i>M. sympodialis</i>	Weichel et al. 2002
Mala s9	Unknown	<i>M. sympodialis</i>	Weichel et al. 2002
Mala s10	Heat shock protein	<i>M. sympodialis</i>	Lindborg et al. 1999
Mala s11	MnSOD	<i>M. sympodialis</i>	Lindborg et al. 1999
Mala s12	GMC oxidoreductase	<i>M. sympodialis</i>	Rasool et al. 2000
Mala s13	Thioredoxin	<i>M. sympodialis</i>	Limacher et al. 2007
MGp42	Heat shock protein	<i>M. globosa</i>	Ishibashi et al. 2009

Table 2. *Malassezia* allergens

4. Treatment with antifungal agents

4.1 Anti-*Malassezia* IgE in the serum of AD patients

Skin prick tests positive for *Malassezia* antigen and specific IgE antibodies have been demonstrated in head and neck AD (HANAD) patients. A delayed-type hypersensitivity to *Malassezia* antigen also seems to play a role. Of 33 HANAD patients, 79% were prick-test positive for *Malassezia* antigen, but only 44% of 22 AD patients without head and neck involvement were prick-test positive (Kieffer *et al.* 1990). Rokugo *et al.* (1990) found that 71% of 35 AD patients who were prick-test positive for *Malassezia* antigen also demonstrated delayed hypersensitivity to *Malassezia* antigen in 64% of 118 AD patients. The presence of anti-*Malassezia* IgE antibody has been demonstrated in several studies (Table 3). The frequency of *Malassezia* specific IgE antibody in serum was higher in AD patients with head and neck dermatitis than without. For example, Bayrou *et al.* (2005) found IgE antibodies against *Malassezia* antigen in 100% of 106 HANAD patients, but in only 28% of 25 AD patients without head and neck involvement. Total IgE levels were also significantly higher in the AD group with head and neck dermatitis (mean, 2,823 kU/L) than without (546 kU/L).

Authors	Patients	Production of anti- <i>Malassezia</i> specific IgE antibodies
Devos and Valk, 2000	HANAD	100% (n=22)
	Non-HANAD	14% (n=22)
Johansson et al. 2003	HANAD	55% (n=98)
	Non-HANAD	19% (n=33)
Jensen-Jarolim et al. 1992	HANAD	68% (n=80)

Table 3. *Malassezia* IgE antibodies in sera of patient with atopic dermatitis

There was also a significant correlation between the level of *Malassezia* specific IgE antibody and clinical severity criteria, as reflected by the SCORAD index ($p < 0.0001$, $r^2 = 0.55$), whereas total IgE showed only a slight correlation with severity criteria ($p < 0.001$, $r^2=0.29$). No correlation was found between age or gender, and specific or total IgE. Based on prick-test results and specific IgE antibody levels, treatment of HANAD patients with antifungal agents has been recommended for the previous two decades.

4.2 Susceptibility of *Malassezia* to drug treatment

Compared with the plethora of antibacterial agents, only a small number of antifungal agents are available, which limits the treatment options for HANAD. Ketoconazole and itraconazole are highly effective *in vitro* (Sugita *et al.* 2005, Miranda *et al.* 2007, Sancak *et al.* 2005, Velegraki *et al.* 2004). In a large-scale study using 125 strains of 11 *Malassezia* species, all of the *Malassezia* species were highly susceptible to both itraconazole and ketoconazole, with minimum inhibitory concentrations (MICs) ranging from 0.016 to 0.25 mg/ml; approximately 80% of the strains had a MIC of ≤ 0.03 mg/ml (Sugita *et al.* (2005). This efficacy is not specific to these species, but applies to all members of the genus *Malassezia*. To our knowledge, no resistant strain has been detected. Ketoconazole and itraconazole are chemically classified as azole compounds, but other azole agents, fluconazole, voriconazole, and terbinafine, cannot inhibit the growth of *Malassezia*.

A calcineurin inhibitor, topical tacrolimus, is widely used to treat AD. This compound had antifungal activity against half of the known *Malassezia* strains, with MICs of 16–32 mg/mL (Sugita *et al.* 2005). The immunosuppressive drugs cyclosporine and tacrolimus target calcineurin and are also toxic to *Candida albicans* and *Cryptococcus neoformans* (Cruz *et al.* 2001). A combination of either ketoconazole or itraconazole and tacrolimus had a synergistic effect against *Malassezia* strains, based on a fractional inhibitory index of 0.245 to 0.378. These observations follow earlier reports on the effectiveness of a combination of tacrolimus and fluconazole against *C. albicans* and *C. neoformans* strains. The combination of topical tacrolimus and an azole agent can simultaneously treat AD and reduce the number of exacerbating *Malassezia* cells colonizing the skin surface. Although the synergistic mechanism of this combination is not known, Maesaki *et al.* (1998) demonstrated that tacrolimus increases the intracellular concentration of the azole agent in *C. albicans*. This observation may provide the basis for future clinical trials of these agents aimed at reducing the number of *Malassezia* cells colonizing the skin of AD patients (more details are provided in the following section).

Authors	Drug	Study design	Number of patients	Dosage
Bäck et al. 1995	Ketoconazole	Open-label study	20 AD patients with positive RAST to <i>Malassezia</i>	200 mg daily for 2 months and 200 mg twice weekly for further 3 months.
Broberg and Faergemann, 1995	Ketoconazole shampoo	Randomized double-blind placebo-controlled study	53 HANAD patients	Group A: miconazole-hydrocortisone cream and ketoconazole shampoo for 6 weeks
				Group B: hydrocortisone cream and placebo shampoo for 6 weeks
Bäck and Bartosik, 2001	Ketoconazole	Randomized double-blind placebo-controlled study	29 HANAD patients with specific IgE antibodies to <i>Malassezia</i>	Group A: 200 mg ketoconazole daily for 3 months
				Group B: placebo for 3 months
Ikezawa et al. 2004	Itraconazole	Randomized double-blind crossover study	34 AD patients with positive RAST to <i>Malassezia</i>	Group A: 100 mg daily of itraconazole and lactobacillus preparation for 8 weeks and lactobacillus preparation alone for further 8 weeks
				Group B: Lactobacillus preparation alone for 8 weeks and 100 mg daily of itraconazole and lactobacillus preparation for additionally 8 weeks
Svejgaard et al. 2005	Itraconazole	Randomized double-blind placebo-controlled study	53 HANAD patients	Group A: 200 mg itraconazole for 7 days
				Group B: 400 mg itraconazole for 7 days
				Group C: placebo

Table 4. Treatment for ketoconazole or itraconazole in HANAD patients

4.3 Ketoconazole and itraconazole in AD treatment (Table 4)

A relationship between *Malassezia* and AD was first suggested by Clemmensen and Hjorth (1983), who demonstrated that oral ketoconazole was efficacious in adult HANAD patients with positive prick tests for *Malassezia*. A study of 20 AD patients with positive radioallergosorbent test results for *Malassezia* showed that treatment with oral ketoconazole

improved clinical scores and reduced the levels of *Malassezia* specific IgE, particularly in the head and neck area (Bäck *et al.* 1995). However, in a double-blind study with 53 HANAD patients, no difference in the clinical score was detected between those treated with miconazole-hydrocortisone cream and ketoconazole shampoo and those treated with hydrocortisone cream and placebo shampoo, although the ketoconazole group showed decreased *Malassezia* colonization (Broberg and Faergemann 1995). In another randomized double-blind placebo-controlled study comparing treatment with 200 mg ketoconazole daily *versus* placebo for 3 months in 29 HANAD patients with specific IgE antibodies to *Malassezia*, the clinical score decreased in both groups, and the improvement was correlated with the use of topical steroids in the control group, but not in the ketoconazole group (Bäck and Bartosik 2001).

A number of studies have also been conducted with itraconazole. In one study, 53 HANAD patients were divided into three groups that received 200 mg itraconazole, 400 mg itraconazole, or placebo daily (Svejgaard *et al.* 2004). The study included a 7-day treatment period and a follow-up period of 105 days. At days 7 and 14, a significant improvement was observed in the SCORAD of the head and neck area in the groups given 400 and 200 mg itraconazole daily. At day 14, a comparison among all three groups showed a significant improvement in the SCORAD of the head and neck area in the 200 mg itraconazole group compared with the placebo group. A randomized double-blind crossover study was also conducted (Ikezawa *et al.* 2004). One group was treated with a combination of itraconazole (100 mg daily) plus a conventional *Lactobacillus* preparation for 8 weeks, followed by the *Lactobacillus* preparation alone for 8 weeks. The other group received the *Lactobacillus* preparation alone for 8 weeks, followed by itraconazole (100 mg daily) plus *Lactobacillus* for 8 weeks. In both groups, a decrease in the dose or strength of concomitant topical steroids was observed at the end of the treatment course with itraconazole, and improvements in the eosinophil count, serum IgE, and fungi-specific IgE were found after the administration of itraconazole.

Itraconazole appears to be a promising treatment option for HANAD patients who do not respond to conventional therapeutic approaches. To optimize the selection of patients most likely to respond to itraconazole treatment, the levels of *Malassezia* colonization of the skin and specific IgE antibody should be evaluated.

5. Acknowledgment

This study was supported in part by a research grant from the Japan Society for the Promotion of Science (TS), a research grant for "High-Tech Research Center Project" from the Ministry of Education, Culture, Sports, Science, and Technology (TS).

6. References

- Albanesi C, Scarponi C, Giustizieri ML, Girolomoni G. 2005, Keratinocytes in inflammatory skin diseases. *Curr Drug Targets Inflamm Allergy*. 4, 329-334.
- Amaya M, Tajima M, Okubo Y, Sugita T, Nishikawa A, Tsuboi R. 2007, Molecular analysis of *Malassezia* microflora in the lesional skin of psoriasis patients. *J Dermatol*. 34, 619-624.
- Ashbee HR. 2007, Update on the genus *Malassezia*. *Med Mycol*. 45, 287-303.

- Bäck O, Scheynius A, Johansson SG. 1995, Ketoconazole in atopic dermatitis: therapeutic response is correlated with decrease in serum IgE. *Arch Dermatol Res.* 287, 448-451.
- Bäck O, Bartosik J. 2001, Systemic ketoconazole for yeast allergic patients with atopic dermatitis. *J Eur Acad Dermatol Venereol* 15, 34-38.
- Bayrou O, Pecquet C, Flahault A, Artigou C, Abuaf N, Leynadier F. 2005, Head and neck atopic dermatitis and malassezia-furfur-specific IgE antibodies. *Dermatology* 211, 107-113.
- Broberg A, Faergemann J. 1995, Topical antimycotic treatment of atopic dermatitis in the head/neck area. A double-blind randomised study. *Acta Derm Venereol.* 75, 46-49.
- Chen L, Martinez O, Overbergh L, Mathieu C, Prabhakar BS, Chan LS. 2004, Early up-regulation of Th2 cytokines and late surge of Th1 cytokines in an atopic dermatitis model. *Clin Exp Immunol.* 138, 375-387.
- Clemmensen OJ, Hjorth N. 1983, Treatment of dermatitis of head and neck with ketoconazole in patients with type 1 sensitivity to *Pityrosporum orbiculare*. *Semin. Dermatol.* 2, 26-29.
- Cruz M C, A L Goldstein, J Blankenship, M Del Poeta, J R Perfect, J H McCusker, Y L Bennani, M E Cardenas, J Heitman. 2001. Rapamycin and less immunosuppressive analogs are toxic to *Candida albicans* and *Cryptococcus neoformans* via FKBP12-dependent inhibition of TOR. *Antimicrob. Agents Chemother.* 45, 3162-3170.
- Devos SA, van der Valk PG. 2000, The relevance of skin prick tests for *Pityrosporum ovale* in patients with head and neck dermatitis. *Allergy.* 55, 1056-1058.
- Esche C, de Benedetto A, Beck LA. 2004, Keratinocytes in atopic dermatitis. inflammatory signals. *Curr Allergy Asthma Rep.* 4, 276-284.
- Grone, A. 2002, Keratinocytes and cytokines. *Vet Immunol Immunopathol.* 88, 1-12.
- Guého-Kellermann E, Boekhout T, Begerow D. 2010, Biodiversity, Phylogeny and Ultrastructure. In *Malassezia* and the skin. Edited by Boekhout, Guého-Kellermann E, Mayser P, and Velegaki A, pp. 17-64, Springer, 2010.
- Gupta AK, Kohli Y, Summerbell RC, Faergemann J. 2001, Quantitative culture of *Malassezia* species from different body sites of individuals with or without dermatoses. *Med Mycol.* 39, 243-251.
- Gupta AK, Batra R, Bluhm R, Boekhout T, Dawson TL Jr. 2004, Skin diseases associated with *Malassezia* species. *J Am Acad Dermatol.* 51, 785-798.
- Hamid Q, Boguniewicz M, Leung DY. 1994, Differential *in situ* cytokine gene expression in acute versus chronic atopic dermatitis. *J Clin Invest.* 94, 870-876.
- Hemmann S, Blaser K, Cramer R. 1997, Allergens of *Aspergillus fumigatus* and *Candida boidinii* share IgE-binding epitopes. *Am J Respir Crit Care Med.* 156, 1956-1962.
- Higaki S, Morohashi M, Yamagishi T, Hasegawa Y. 1999, Comparative study of staphylococci from the skin of atopic dermatitis patients and from healthy subjects. *Int J Dermatol.* 38, 265-269.
- Hoeger PH, Lenz W, Boutonnier A, Fournier JM. 1992, Staphylococcal skin colonization in children with atopic dermatitis: prevalence, persistence, and transmission of toxigenic and nontoxigenic strains. *J Infect Dis.* 165, 1064-1068.
- Howell MD. 2007, The role of human beta defensins and cathelicidins in atopic dermatitis. *Curr Opin Allergy Clin Immunol.* 7, 413-417.

- Ikezawa Z, Kondo M, Okajima M, Nishimura Y, Kono M. 2004, Clinical usefulness of oral itraconazole, an antimycotic drug, for refractory atopic dermatitis. *Eur J Dermatol.* 14, 400-406.
- Ishibashi Y, Sugita T, Nishikawa A. 2006, Cytokine secretion profile of human keratinocytes exposed to *Malassezia* yeasts. *FEMS Immunol Med Microbiol.* 48, 400-409.
- Ishibashi Y, Kato H, Asahi Y, Sugita T, Nishikawa A. 2009, Identification of the major allergen of *Malassezia globosa* relevant for atopic dermatitis. *J Dermatol. Sci.* 55, 185-192.
- Jensen-Jarolim E, Poulsen LK, With H, Kieffer M, Ottevanger V, Stahl Skov P. 1992, Atopic dermatitis of the face, scalp, and neck: type I reaction to the yeast *Pityrosporum ovale*? *J Allergy Clin Immunol.* 89, 44-51.
- Johansson C, Sandström MH, Bartosik J, Särnhult T, Christiansen J, Zargari A, Bäck O, Wahlgren CF, Faergemann J, Scheynius A, Tengvall Linder M. 2003, Atopy patch test reactions to *Malassezia* allergens differentiate subgroups of atopic dermatitis patients. *Br J Dermatol* 148, 479-488.
- Kaga M, Sugita T, Nishikawa A, Wada Y, Hiruma M, Ikeda S. 2011, Molecular analysis of the cutaneous *Malassezia* microbiota from the skin of patients with atopic dermatitis of different severities. *Mycoses* 54, e24-28.
- Kakinuma T, Saeki H, Tsunemi Y, Fujita H, Asano N, Mitsui H, Tada Y, Wakugawa M, Watanabe T, Torii H, Komine M, Asahina A, Nakamura K, Tamaki K. 2003, Increased serum cutaneous T cell-attracting chemokine (CCL27) levels in patients with atopic dermatitis and psoriasis vulgaris. *J Allergy Clin Immunol.* 111, 592-597.
- Kaneko T, Makimura K, Abe M, Shiota R, Nakamura Y, Kano R, Hasegawa A, Sugita T, Shibuya S, Watanabe S, Yamaguchi H, Abe S, Okamura N. 2007, Revised culture-based system for identification of *Malassezia* species. *J Clin Microbiol.* 45, 3737-3742.
- Kato H, Sugita T, Ishibashi Y, Nishikawa A. 2006, Detection and quantification of specific IgE antibodies against eight *Malassezia* species in sera of patients with atopic dermatitis by using an enzyme-linked immunosorbent assay. *Microbiol Immunol.* 50, 851-856.
- Kieffer M, Bergbrant I-M, Faergeman J, Jemec GBE, Ottevanger V, Skov PS, Svejgaard E. 1990, Immune reactions to *Pityrosporum ovale* in adult patients with atopic and seborrhoeic dermatitis. *J. Am. Acad. Dermatol.* 22, 739-742.
- Leung DY. 2000, Atopic dermatitis. new insights and opportunities for therapeutic intervention. *J Allergy Clin Immunol.* 105, 860-876.
- Limacher A, Glaser AG, Meier C, Schmid-Grendelmeier P, Zeller S, Scapozza L, Cramer R. 2007, Cross-reactivity and 1.4-Å crystal structure of *Malassezia sympodialis* thioredoxin (Mala s 13), a member of a new pan-allergen family. *J Immunol* 178, 389-396.
- Lindborg M, Magnusson CG, Zargari A, Schmidt M, Scheynius A, Cramer R, Whitley P. 1999, Selective cloning of allergens from the skin colonizing yeast *Malassezia furfur* by phage surface display technology. *J Invest Dermatol* 113, 156-161.
- Maesaki S, P Marichal, M A Hossain, D Sanglard, H Vanden Bossche, S Kohno. 1998, Synergic effects of tacrolimus and azole antifungal agents against azole-resistant *Candida albican* strains. *J. Antimicrob. Chemother.* 42, 747-753.
- Miranda KC, de Araujo CR, Costa CR, Passos XS, de Fátima Lisboa Fernandes O, do Rosário Rodrigues Silva M. 2007, Antifungal activities of azole agents against the *Malassezia* species. *Int J Antimicrob Agents.* 29, 281-284.

- Morales J, Homey B, Vicari AP, Hudak S, Oldham E, Hedrick J, Orozco R, Copeland NG, Jenkins NA, McEvoy LM, Zlotnik A. 1999, CTACK, a skin-associated chemokine that preferentially attracts skin-homing memory T cells. *Proc Natl Acad Sci USA* 96, 14470-14475.
- Morishita N, Sei Y, Sugita T. 2006, Molecular analysis of malassezia microflora from patients with pityriasis versicolor. *Mycopathologia* 161, 61-65.
- Nakabayashi A, Sei Y, Guillot J. 2000, Identification of *Malassezia* species isolated from patients with seborrhoeic dermatitis, atopic dermatitis, pityriasis versicolor and normal subjects. *Med Mycol.* 38, 337-341.
- Onishi Y, Kuroda M, Yasueda H, Saito A, Sono-Koyama E, Tunasawa S, Hashida-Okado T, Yagihara T, Uchida K, Yamaguchi H, Akiyama K, Kato I, Takesako K. 1999, Two-dimensional electrophoresis of *Malassezia* allergens for atopic dermatitis and isolation of Mal f 4 homologs with mitochondrial malate dehydrogenase. *Eur J Biochem.* 261, 148-154.
- Rasool O, Zargari A, Almqvist J, Eshaghi H, Whitley P, Scheynius A. 2000, Cloning, characterization and expression of complete coding sequences of three IgE binding *Malassezia furfur* allergens, Mal f 7, Mal f 8 and Mal f 9. *Eur J Biochem* 267, 4355-4361.
- Rokugo M, Tagami H, Usuba Y, Tomita Y. 1990, Contact sensitivity to *Pityrosporum ovale* in patients with an atopic dermatitis. *Arch. Dermatol.* 126, 627-634.
- Sancak B, Ayhan M, Karaduman A, Arikan S. 2005, In vitro activity of ketoconazole, itraconazole and terbinafine against *Malassezia* strains isolated from neonates. *Mikrobiyol Bul.* 39, 301-308. Turkish.
- Sandström Falk MH, Tengvall Linder M, Johansson C, Bartosik J, Bäck O, Särnhult T, Wahlgren CF, Scheynius A, Faergemann J. 2005, The prevalence of *Malassezia* yeasts in patients with atopic dermatitis, seborrhoeic dermatitis and healthy controls. *Acta Derm Venereol.* 85, 17-23.
- Schmidt M, Zargari A, Holt P, Lindbom L, Hellman U, Whitley P, van der Ploeg I, Härfast B, Scheynius A. 1997, The complete cDNA sequence and expression of the first major allergenic protein of *Malassezia furfur*, Mal f 1. *Eur J Biochem* 246, 181-185.
- Schmid-Grendelmeier P, Flückiger S, Disch R, Trautmann A, Wüthrich B, Blaser K, Scheynius A, Cramer R. 2005, IgE-mediated and T cell-mediated autoimmunity against manganese superoxide dismutase in atopic dermatitis. *J Allergy Clin Immunol* 115, 1068-1075.
- Schmid-Grendelmeier P, Scheynius A, Cramer R. 2006, The role of sensitization to *Malassezia sympodialis* in atopic eczema. *Chem Immunol Allergy* 91, 98-109.
- Seidenari S, Giusti G. 1995, Objective assessment of the skin of children affected by atopic dermatitis: a study of pH, capacitance and TEWL in eczematous and clinically uninvolved skin. *Acta Derm Venereol.* 75, 429-433.
- Sugita T, Suto H, Unno T, Tsuboi R, Ogawa H, Shinoda T, Nishikawa A. 2001, Molecular analysis of *Malassezia* microflora on the skin of atopic dermatitis patients and healthy subjects. *J Clin Microbiol.* 39, 3486-3490.
- Sugita T, Kodama M, Saito M, Ito T, Kato Y, Tsuboi R, Nishikawa A. 2003, Sequence diversity of the intergenic spacer region of the rRNA gene of *Malassezia globosa* colonizing the skin of patients with atopic dermatitis and healthy individuals. *J Clin Microbiol.* 41, 3022-3027.

- Sugita T, Tajima M, Amaya M, Tsuboi R, Nishikawa A. 2004, Genotype analysis of *Malassezia restricta* as the major cutaneous flora in patients with atopic dermatitis and healthy subjects. *Microbiol Immunol.* 48, 755-759.
- Sugita T, Tajima M, Ito T, Saito M, Tsuboi R, Nishikawa A. 2005, Antifungal activities of tacrolimus and azole agents against the eleven currently accepted *Malassezia* species. *J Clin Microbiol.* 43, 2824-2829.
- Sugita T, Tajima M, Tsuboku H, Tsuboi R, Nishikawa A. 2006a, Quantitative analysis of cutaneous *Malassezia* in atopic dermatitis patients using real-time PCR. *Microbiol Immunol.* 50, 549-552.
- Sugita T, Boekhout T, Velegraki A, Guillot J, Hadina S, Cabanes FJ. 2010, Epidemiology of *Malassezia*-related skin diseases. In *Malassezia and the skin*. Edited by Boekhout, Guého-Kellermann E, Mayser P, and Velegraki A, pp. 65-120, Springer, 2010.
- Sugita T, Zhang E, Miyamoto M, Tajima M, Tsuboi R, Nishikawa A. 2011, Chapter 73 *Malassezia*, In *Molecular Detection of Human Fungal Pathogens*. Edited by Dongyou Liu, Taylor & Francis Group. 631-638.
- Svejgaard E, Larsen PØ, Deleuran M, Ternowitz T, Roed-Petersen J, Nilsson J. 2004, Treatment of head and neck dermatitis comparing itraconazole 200 mg and 400 mg daily for 1 week with placebo. *J Eur Acad Dermatol Venereol.* 18, 445-449.
- Tajima M, Sugita T, Nishikawa A, Tsuboi R. 2008, Molecular analysis of *Malassezia* microflora in seborrheic dermatitis patients: comparison with other diseases and healthy subjects. *J Invest Dermatol.* 128, 345-351.
- Takahata Y, Sugita T, Hiruma M, Muto M. 2007a, Quantitative analysis of *Malassezia* in the scale of patients with psoriasis using a real-time polymerase chain reaction assay. *Br J Dermatol.* 157, 670-673.
- Takahata Y, Sugita T, Kato H, Nishikawa A, Hiruma M, Muto M. 2007b, Cutaneous *Malassezia* flora in atopic dermatitis differs between adults and children. *Br J Dermatol.* 157, 1178-1182.
- Velegraki A, Alexopoulos EC, Kritikou S, Gaitanis G. 2004, Use of fatty acid RPMI 1640 media for testing susceptibilities of eight *Malassezia* species to the new triazole posaconazole and to six established antifungal agents by a modified NCCLS M27-A2 microdilution method and Etest. *J Clin Microbiol.* 42, 3589-3593.
- Watanabe S, Kano R, Sato H, Nakamura Y, Hasegawa A. 2001, The effects of *Malassezia* yeasts on cytokine production by human keratinocytes. *J Invest Dermatol.* 116, 769-773.
- Weichel M, Fluckiger S, Cramer R. 2002. Molecular characterization of mould allergens involved in respiratory complications. *Rencet Res devel Resp Critical Care Med.* 2, 29-45.
- Witmer-Pack MD, Olivier W, Vaiinsky J. 1987, Granulocyte-macrophage colony-stimulating factor is essential for the viability and function of cultured murine epidermal Langerhans cells. *J Exp Med.* 166, 1484-1498.
- Xu J, Saunders CW, Hu P, Grant RA, Boekhout T, Kuramae EE, Kronstad JW, Deangelis YM, Reeder NL, Johnstone KR, Leland M, Fieno AM, Begley WM, Sun Y, Lacey MP, Chaudhary T, Keough T, Chu L, Sears R, Yuan B, Dawson TL Jr. 2007, Dandruff-associated *Malassezia* genomes reveal convergent and divergent virulence traits shared with plant and human fungal pathogens. *Proc Natl Acad Sci U S A.* 104, 18730-18735.

- Yamamoto A, Serizawa S, Ito M, Sato Y. 1991, Stratum corneum lipid abnormalities in atopic dermatitis. *Arch Dermatol Res.* 283, 219-223.
- Yasueda H, Hashida-Okado T, Saito A, Uchida K, Kuroda M, Onishi Y, Takahashi K, Yamaguchi H, Takesako K, Akiyama K. 1998. Identification and cloning of two novel allergens from the lipophilic yeast, *Malassezia furfur*. *Biochem Biophys Res Commun.* 248, 240-244.
- Zargari A, Midgley G, Bäck O, Johansson SG, Scheynius A. 2003, IgE-reactivity to seven *Malassezia* species. *Allergy* 58, 306-311.
- Zhang E, Tanaka T, Tajima M, Tsuboi R, Nishikawa A, Sugita T. 2011, Characterization of the skin fungal microbiota in patients with atopic dermatitis and healthy subjects. *Microbiol Immunol* Jun 24. doi: 10.1111/j.1348-0421.2011.00364.x. [Epub ahead of print]

IntechOpen

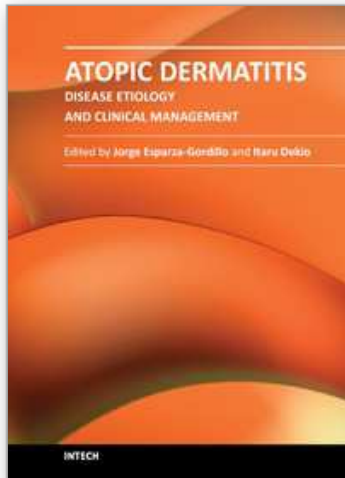

Atopic Dermatitis - Disease Etiology and Clinical Management

Edited by Dr. Jorge Esparza-Gordillo

ISBN 978-953-51-0110-9

Hard cover, 414 pages

Publisher InTech

Published online 22, February, 2012

Published in print edition February, 2012

Atopic Dermatitis is a common disease characterized by inflamed, itching and dry skin. This relapsing allergic disorder has complex etiology and shows a remarkably high clinical heterogeneity which complicates the diagnosis and clinical management. This book is divided into 4 sections. The first section (Disease Etiology) describes some of the physiological mechanisms underlying Atopic Dermatitis, including alterations in the immune system and the skin-barrier function. The important role of host-microorganism interactions on the pathophysiology of Atopic Dermatitis is discussed in the second section (Microorganisms in Atopic Dermatitis). An overview of the clinical diagnostic criteria and the disease management protocols commonly used is given in the third section (Diagnosis and Clinical Management). The last section (New Treatments) describes new therapeutic approaches that are not widely used but are currently being studied due to preliminary evidence showing a clinical benefit for Atopic Dermatitis.

How to reference

In order to correctly reference this scholarly work, feel free to copy and paste the following:

Takashi Sugita, Enshi Zhang, Takafumi Tanaka, Mami Tajima, Ryoji Tsuboi, Yoshio Ishibashi, Akemi Nishikawa (2012). Atopic Dermatitis and Skin Fungal Microorganisms, Atopic Dermatitis - Disease Etiology and Clinical Management, Dr. Jorge Esparza-Gordillo (Ed.), ISBN: 978-953-51-0110-9, InTech, Available from: <http://www.intechopen.com/books/atopic-dermatitis-disease-etiology-and-clinical-management/atopic-dermatitis-and-skin-fungal-microorganisms>

INTECH
open science | open minds

InTech Europe

University Campus STeP Ri
Slavka Krautzeka 83/A
51000 Rijeka, Croatia
Phone: +385 (51) 770 447
Fax: +385 (51) 686 166
www.intechopen.com

InTech China

Unit 405, Office Block, Hotel Equatorial Shanghai
No.65, Yan An Road (West), Shanghai, 200040, China
中国上海市延安西路65号上海国际贵都大饭店办公楼405单元
Phone: +86-21-62489820
Fax: +86-21-62489821

© 2012 The Author(s). Licensee IntechOpen. This is an open access article distributed under the terms of the [Creative Commons Attribution 3.0 License](#), which permits unrestricted use, distribution, and reproduction in any medium, provided the original work is properly cited.

IntechOpen

IntechOpen