

We are IntechOpen, the world's leading publisher of Open Access books Built by scientists, for scientists

4,400

Open access books available

117,000

International authors and editors

130M

Downloads

Our authors are among the

154

Countries delivered to

TOP 1%

most cited scientists

12.2%

Contributors from top 500 universities



WEB OF SCIENCE™

Selection of our books indexed in the Book Citation Index
in Web of Science™ Core Collection (BKCI)

Interested in publishing with us?
Contact book.department@intechopen.com

Numbers displayed above are based on latest data collected.
For more information visit www.intechopen.com



A Mobile WiMAX Architecture with QoE Support for Future Multimedia Networks

José Jailton¹, Tássio Carvalho¹, Warley Valente¹, Renato Frânces¹,
Antônio Abelém¹, Eduardo Cerqueira¹ and Kelvin Dias²

¹*Federal University of Pará,*

²*Federal University of Pernambuco,
Brazil*

1. Introduction

The permanent evolution of future wireless network technologies together with demand for new multimedia applications, has driven a need to create new wireless, mobile and multimedia-awareness systems. In this context, the IEEE 802.16 Standard (IEEE 802.16e, 2005), also known as WiMAX (WorldWide Interoperability for Microwave Access) is an attractive solution for last mile Future Multimedia Internet (Sollner, 2008) , particularly because of its wide coverage range and throughput support.

The IEEE 802.16e extension, also known as Mobile WiMAX, supports mobility management with the Mobile Internet Protocol version 6 (MIPv6). This provides service connectivity in handover scenarios, by coordinating layer 2 (MAC layer) and layer 3 (IP layer) mobility mechanisms (Neves, 2009) . In addition to mobility control issues, an end-to-end quality level support for multimedia applications is required to satisfy the growing demands of fixed and mobile users, while increasing the profits of the content providers.

With regard to Quality of Service (QoS) control, the WiMAX system provides service differentiation based on the combination of a set of communication service classes supported by both wired IP-based and wireless IEEE 802.16-based links. In the case of the former, network elements with IP standard QoS models, such as Differentiated Services (DiffServ) and Integrated Services (IntServ), Multiprotocol Label Switching (MPLS) can be configured to guarantee QoS support for applications crossing wired links. In the latter, several IEEE 802.16 QoS services can be defined to provide service differentiation in the wireless interface (IEEE 802.16e, 2005).

Four services designed to support different type of data flows can be defined as follows: (i) Unsolicited Granted Service (UGS) for Constant Bit Rate (CBR) traffic, such as Voice over IP (VoIP). (ii) The Real Time Polling Service (rtPS) for video-alike traffic. (iii) The Non-Real Time Polling Service for an application with minimum bandwidth guarantees, such as File Transfer Protocol (FTP). Finally, (iv) the Best Effort (BE) service which does not have QoS guarantees (e.g., web and e-mail traffic) (Neves, 2009) (Ahmet et Al, 2009).

Existing QoS metrics, such as packet loss rate, packet delay rate and throughput, are generally used to measure the impact on the quality level of multimedia streaming from the

perspective of the network, but do not reflect the user's experience. As a result, these QoS parameters fail to reflect subjective factors associated with human perception. In order to overcome the limitations of current QoS-aware multimedia networking schemes with respect to human perception and subjective factors, recent advances in multimedia-aware systems, called Quality of Experience (QoE) approaches, have been introduced. Hence, new challenges in emerging networks involve the study, creation and the validation of QoE measurements and optimization mechanisms to improve the overall quality level of multimedia streaming content, while relying on limited wireless network resources (Winkler, 2005).

In this chapter, there will be an overview of the most recent advances and challenges in WiMAX and multimedia systems, which will address the key issues of seamless mobility, heterogeneity, QoS and QoE. Simulation experiments were carried out to demonstrate the benefits and efficiency of a Mobile WiMAX environment in controlling the quality level of ongoing multimedia applications during handovers. These were conducted, by using the Network Simulator 2 (ns-2, 2010) and the Video Quality Evaluation Tool-set Evalvid. Moreover, well-known QoE metrics, including Peak Signal-to-Noise Ratio (PSNR), Video Quality Metric (VQM), Structural Similarity Index (SSIM) and Mean Opinion Score (MOS), are used to analyze the quality level of real video sequences in a wireless system and offer support for our proposed mechanisms.

2. WiMAX network infrastructure

A number of WiMAX schemes, such as mobility management for the handover and user authentication, require the coordination of a wide range of elements in a networking system. The implementation of these features is far beyond the definition of IEEE 802.16, since this only adds to the physical layer components that are needed for modulation settings and the air interface between the base stations and customer, together with the definitions of what comprises the Medium Access Control (MAC) layer.

With the WiMAX Forum, it was possible to standardize all the main elements of a WiMAX network, including mobile devices and network infrastructure components. In this way, interoperability between the networks was ensured even when they had different manufacturers. However, there are several outstanding issues related to QoS, QoE, seamless handover and multimedia approaches that must be addressed before the overall performance of the Multimedia Mobile WiMAX system can be improved.

2.1 General architecture

The development of a WiMAX architecture follows several principles, most of which are applicable to general issues in IP networks. Figure 1 illustrates a generic Heterogeneous Mobile WiMAX scenario.

The WiMAX architecture should provide connectivity support, QoS, QoE and seamless mobility, independently of the underlying network technologies, QoS models and available service classes. The system should also enable the network resources to be shared, by allowing a clear distinction to be drawn between the Network Access Provider (NAP), an organization that provides access to the network and the Network Service Provider (NSP),

an entity that deals with customer service and offers access to broadband applications and large Service Providers (ASP).

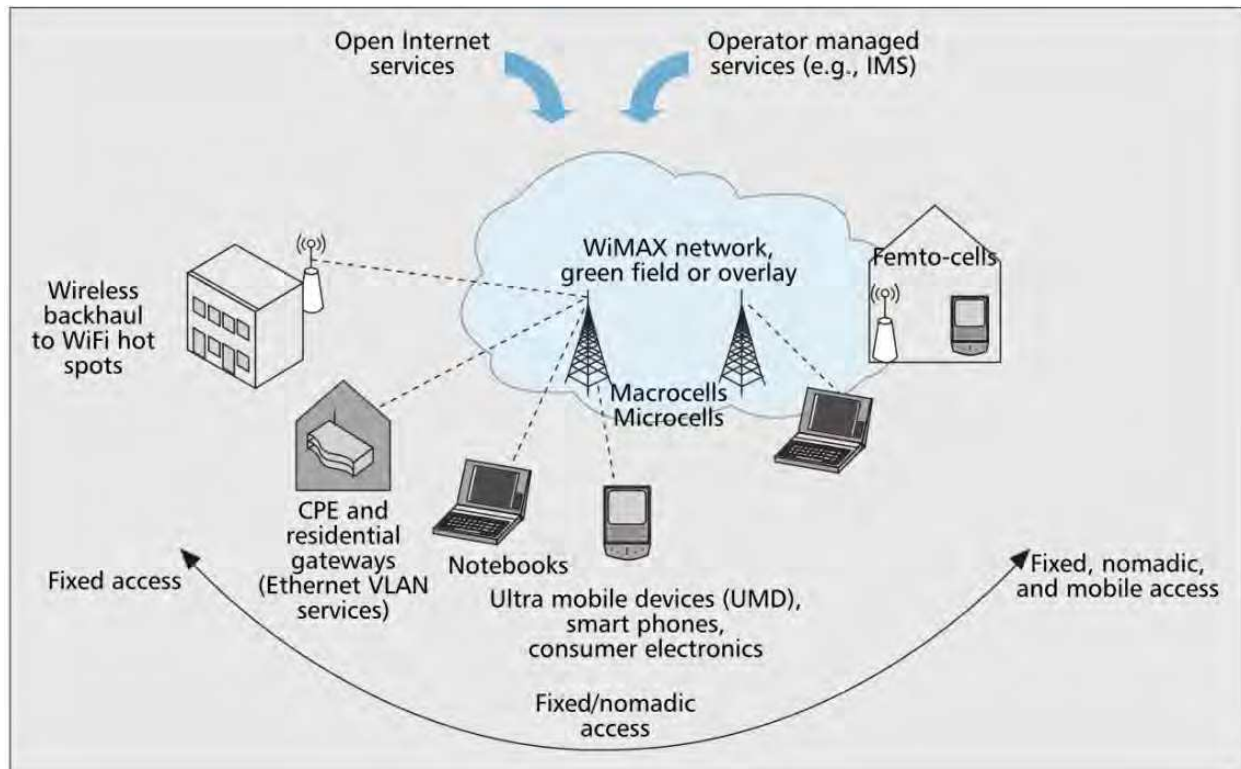

Fig. 1. Heterogeneous Mobile WiMAX System (Eteamed ,2008).

This section addresses the end-to-end network system architecture of WiMAX, based on the WiMAX Forum's Network Working Group (NWG), which includes issues related to and beyond the scope of (IEEE 802.16-2009). The Network Reference Model (NRM) with the WiMAX Architecture will also be introduced and various functional entities and their respective connections and responsibilities explained.

2.2 Network architecture

The WiMAX network architecture is usually represented by a NRM in most modern research papers and technical reports. This model describes the functional entities and reference points for an interoperable system based on the WiMAX Forum. The NRM usually has some Subscriber Stations (MS) (clients, customers, subscriber stations, etc), Access Service Network (ASN) and Connectivity Service Network (CSN) with their interactions which are expected to continue through the reference points. Figure 2 shows the defined reference points R1 to R8 which represent the communications between the network elements.

The WiMAX NRM differentiates between NAPs and NSPs, where the former are business entities that provide the infrastructure and access to the WiMAX network that contains one or more ASNs. At a high level, these NAPs are the service providers and their infrastructure with a shared wireless access. The NSPs are business entities that provide IP connectivity and WiMAX services to the subscriber stations in accordance with service level agreements or other agreements. The NSP can have control over the CSN (Iyer, 2008).

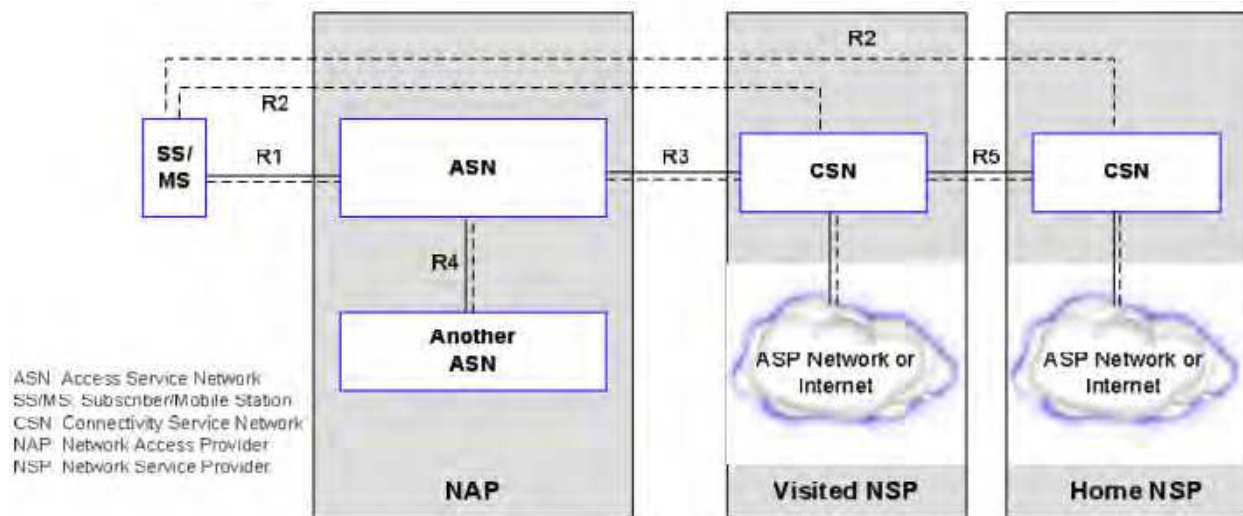

Fig. 2. Network Reference Model (Iyer, 2008)

The Network Reference Model divides the system into three distinct parts: (i) the Mobile Stations used by customers to access the network, (ii) the ASN which is owned by a NAP and has one or more base stations and one or more ASN gateways and (iii) the CSN which is owned by a NSP and provides IP connectivity and all IP core network functionalities.

The SS are used by customers, subscriber stations and any mobile equipment with a wireless interface linked to one or more hosts of a WiMAX network. These devices can initiate a new connection once the presence of a new base in an ASN has been verified.

The ASN is the ingress point of a WiMAX network, where the MS must be connected. Hence, the MS has to follow a set of steps and corresponding functions for authentication and boot process to request and receive access to the network and, thus establish, the connectivity (Ahmadi, 2009) (Vaidehi & Poorani, 2010). The ASN can have one or more Base Stations (BS) and one or more ASN-GW (Access Service Network - Gateway). All the ASNs have the following mandatory functions:

- IEEE 802.16-2009 layer 2 connectivity with the Mobile Station;
- AAA (Authentication, Authorization and Accounting) Proxy: messages to client's home network with authentication, authorization and accounting to the mobile station;
- Radio Resource Management and the QoS policy;
- Network discovery and selection;
- Relay functionality for establishing IP connectivity with WiMAX MS;
- Mobile functions such as handover (support for mobile IP), location control, etc.

The CSN supports a set of network functions that provide IP connectivity to the WiMAX clients and customers. A CSN usually has many network elements such as routers, database, AAA servers, DHCP servers, gateways, providers, etc. The CSN can provide the following functions:

- IP address allocation to the mobile station;
- Policy, admission control and QoS managements based on service level agreements (SLA)/a contract with the user;

- Support for roaming between NSPs;
- Mobility management and mobile IP home agent functionality;
- Connectivity, infrastructure and policy control;
- Interoperability and billing solution;
- AAA proxy for devices, clients and services such as IP multimedia services (IMS).

The combination of these three elements form the WiMAX network reference model defined by the WiMAX Forum, together with the IEEE Standard 802.16-2009. Each function requires interaction between two or more functional entities and may operate one or more physical devices.

2.3 QoS architecture

WiMAX is one of the most recent broadband technologies for Wireless Metropolitan Area Networks (WMANs). To allow users to access, share and create multimedia content with different QoS requirements, WiMAX implements a set of QoS Class of Services (CoS) at the MAC layer as discussed earlier, (UGS, rtPS, ertPS, nrtPS and BE).

The UGS is designed to support real-time and delay/loss sensitive applications, such as voice. It is characterized by fixed-size data packets, requiring fixed bandwidth allocation and a low delay rate. The rtPS is similar to UGS regarding real-time requirements, but it is suitable for delay-tolerant with variable packet sizes, such as Moving Pictures Experts Group (MPEG) video transmission and interactive gaming.

The ertPS was recently defined by the IEEE 802.16 standard to support real-time content with a QoS/QoE requirement between UGS and rtPS. The BS provides grants in an unsolicited manner (as in UGS), with dynamic bandwidth allocation which is needed for some voice applications with silence suppression.

The nrtPS is associated with non real-time traffic with high throughput requirements, such as FTP transmission. The BS performs individual polling for SSs bandwidth requests. The BE is designed for applications without guarantees in terms of delay, loss or bit-rate. An example is web browsing and e-mail (Chrost & Brachman, 2010) (Ahson & Ilyas, 2007).

Each CoS has a mandatory set of QoS parameters that must be included in the service flow definition when the class of service is adapted to a service flow. The main parameters are the following: traffic priority, maximum latency, jitter, maximum and minimum data rate and maximum delay. Table 1 provides an overview of the five WiMAX class of services, typical applications and corresponding QoS parameters.

The MAC layer of the IEEE 802.16 standard is connection-oriented. Signaling messages between BS and SS must be exchanged so that a service flow can be established between them. A Service Flow (SF) is a MAC transport service that provides unidirectional transport of packets on the uplink or on the downlink. Each service flow is characterized by a set of QoS parameters that indicate the latency and jitter that is necessary and ensures throughput. In addition, each service flow receives a unique Service Flow Identifier (SFID) from the BS, a long integer of 32 bits, to allow each individual service flow to be identified. For any active service flow, a connection is discovered by a Connection Identifier (CID), a piece of information coded in 16 bits. A connection is a unidirectional mapping between a BS and a

SS MAC peers for the purpose of transporting the traffic of a service flow. Thus, a CID will be assigned for each connection between BS and SS associated with a service flow.

Scheduling service	Corresponding data delivery service	Typical applications	QoS specifications
Unsolicited Grant Service (UGS)	Unsolicited grant service (UGS)	Voice (VoIP) without silence suppression	Maximum sustained rate Maximum latency tolerance Jitter tolerance
Extended Real-Time Polling Service (ertPS)	Extended realtime variable-rate service (ERT-VR)	VoIP with silence suppression	Maximum sustained rate Minimum reserved rate Maximum latency tolerance Jitter tolerance Traffic priority
Real-Time Polling Service (rtPS)	Real-time variable-rate service (RT-VR)	Streaming audio or video	Maximum sustained rate Minimum reserved rate Maximum latency tolerance Traffic priority
Non-Real-Time Polling Service (nrtPS)	Non-real-time variable rate service (NRT-VR)	File Transfers Protocol (FTP)	Maximum sustained rate Minimum reserved rate Traffic priority
Best-Effort Service (BE)	Best-effort service (BE)	Web browsing, e-mail	Maximum sustained rate Traffic priority

Table 1. WiMAX scheduling and data delivery service classes, including applications and QoS parameters.

Figure 3 outlines the WiMAX QoS architecture as defined by the IEEE 802.16 standard. It can be observed that schedulers, QoS parameters and classifiers are present in the MAC layer of both the Base Station (BS) and Subscriber Station (SS). The BS is responsible for managing and maintaining the QoS for all of the packet transmissions. The BS manages this by actively distributing usage time to subscriber stations through information embedded in the transmitted management frames, as illustrated in Figure 4.

Communication between BS and SS can be initiated by the BS (mandatory condition) or by the SS (optional condition). In both cases, it is necessary for there to be a connection request to the Connection Admission Control (CAC) located in the BS. The CAC is responsible for accepting or rejecting a connectivity request. Its decisions are based on the QoS parameters contained in the request messages - Dynamic Service Addition Request (DSA-REQ). If the QoS parameters are within the limits of the available resources, and this is the case, the BS then replies with an acceptance message - Dynamic Service Addition Response (DSA-RSP) - and assigns a unique SFID for the new service flow.

The service flow is then classified and mapped into a particular connection for transmission between the MAC peers. The mapping process associates a data packet with a connection, which also creates a link with the service flow characteristics of this connection.

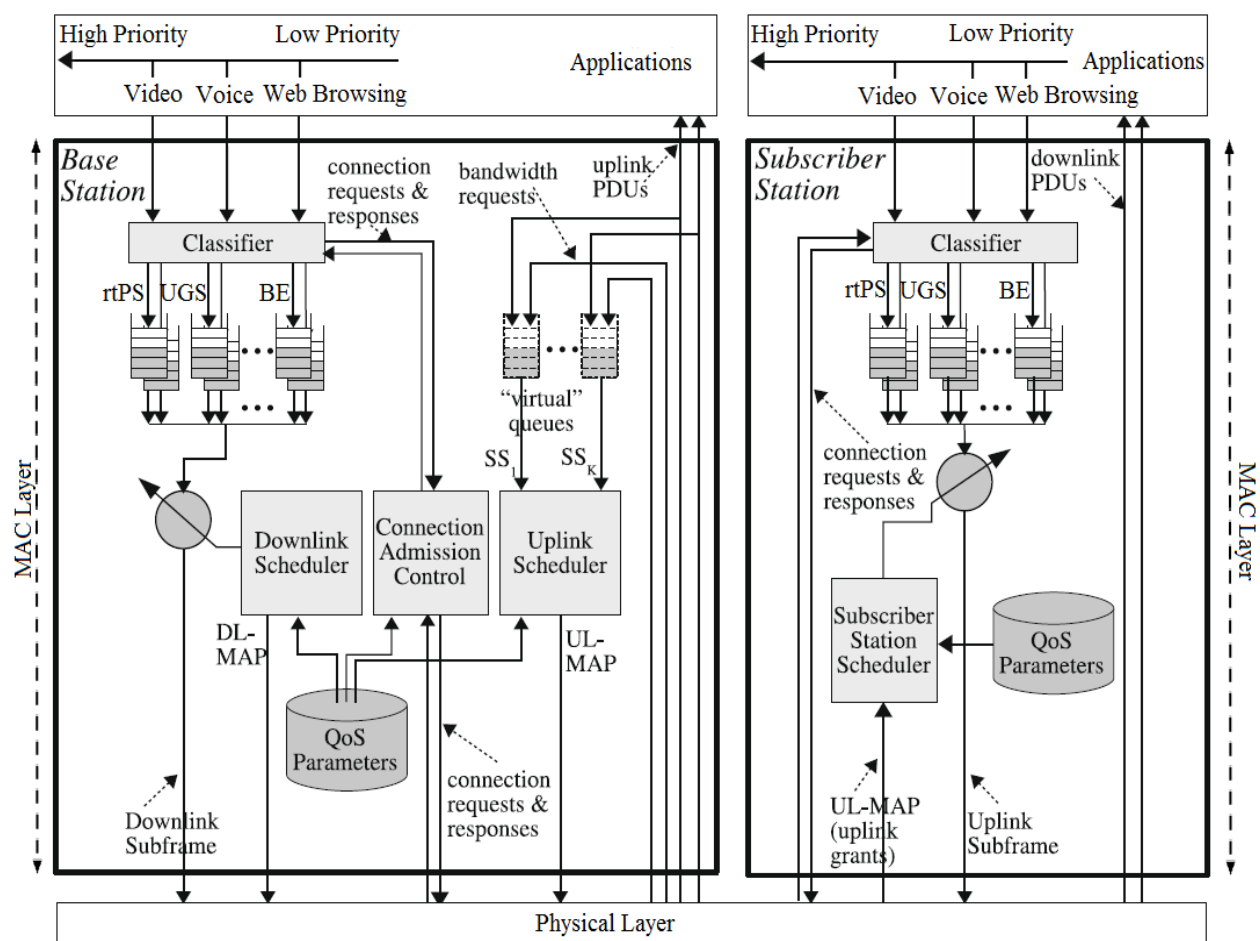

Fig. 3. Overall Architecture of WiMAX QoS.

After the process of classification has been completed,, the most complex aspect of the provision of QoS to individual packets is performed by the three schedulers: downlink and uplink schedulers located at BS, and responsible for managing the flows in the downlink and uplink respectively, and subscriber station schedulers, which together manage flows in the uplink or the SS-to-BS flows.

The aim of a scheduler is generally to determine the burst profile and the transmission periods for each connection, while taking into account the QoS parameters associated with the service flow, the bandwidth requirements of the subscriber stations and the parameters for coding and modulation.

The Downlink Scheduler's task is relatively simple compared to that of the Uplink Scheduler, since all the downlink queues reside in the BS and their state is locally accessible to the scheduler. The decisions regarding the time allocation of bandwidth usage are transmitted to the SSs through the DL-MAP (Downlink Bandwidth Allocation Map) MAC management message, located in the downlink sub-frame, as shown in Figure 4. This field notifies the SSs of the timetable and physical layer properties for transmitting subsequent bursts of packets.

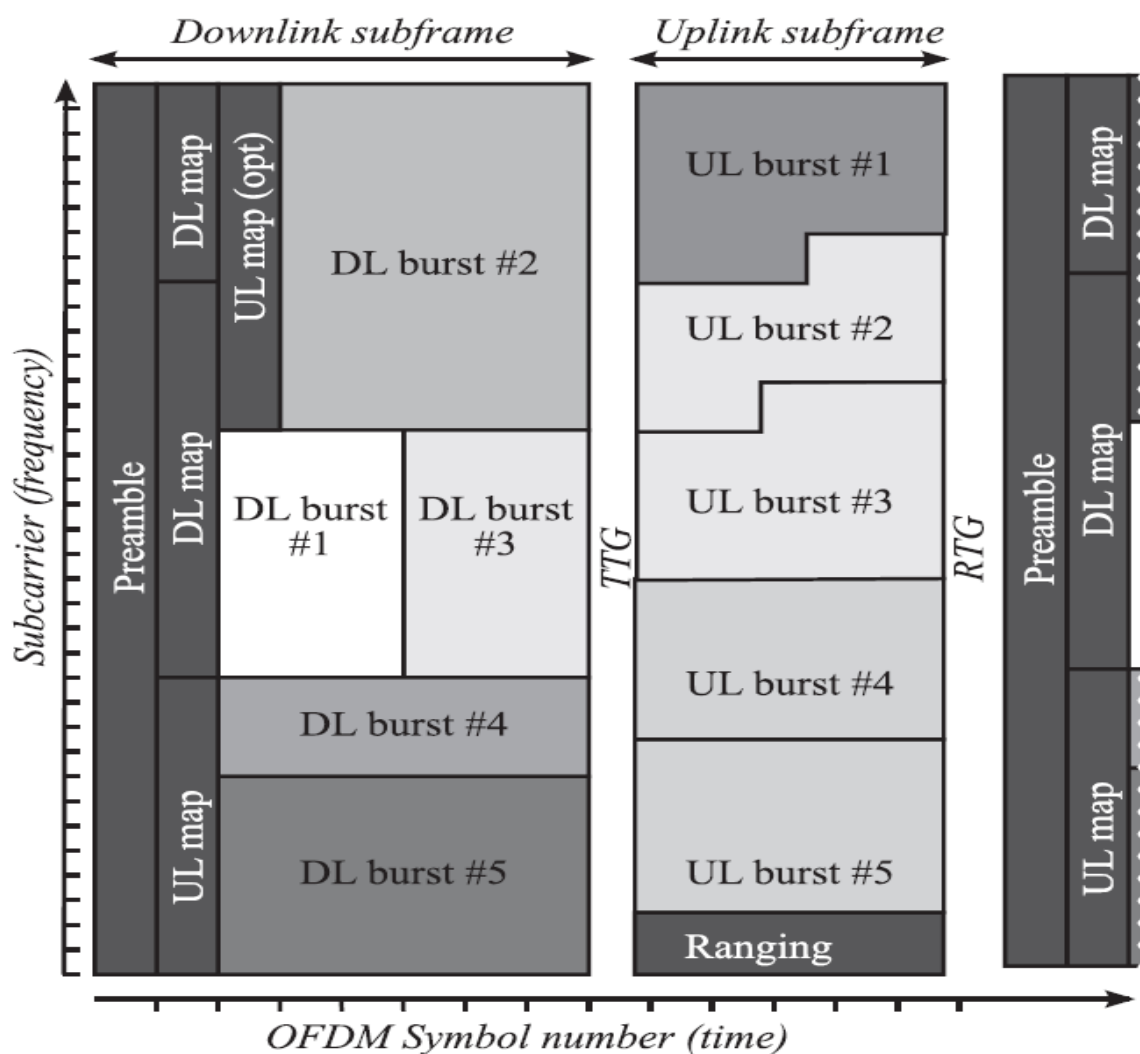

Fig. 4. WiMAX frame structure.

The task of the Uplink Scheduler is much more complex. Since queues of uplink packet flows are distributed among the SSs, their states and QoS requirements have to be obtained through bandwidth requests. The information gathered from the remote queues, forms the operational basis of the uplink scheduler and is displayed as “virtual queues”, as can be seen in Figure 1. The uplink scheduler will select uplink allocations based on the bandwidth requests, QoS parameters and priorities of the service classes. These decisions are transmitted to the SSs through the UL-MAP (Uplink Bandwidth Allocation Map) which is the MAC management message for regulating the uplink transmission rights of each SS. Thus, the UL-MAP controls the amount of time that each SS is provided with access to the channel in the immediately following or the next uplink sub-frame(s) (Sekercioglu, 2009).

The uplink sub-frame of the WiMAX management frame should also be mentioned.. This sub-frame basically contains three fields: initial ranging (Ranging), bandwidth requests (BW-REQ) and specific slots.

Initial ranging is used by SSs to discover the optimum transmission power, as well as the timing and frequency offset needed to communicate with the BS. The bandwidth requests contention slot is used by the SSs for transmitting bandwidth request MAC messages. These are the slots that are specifically allocated to the individual SSs for transmitting data.

The scheduler of an SS visits the queues and selects packets for transmission. The selected packets are transmitted to the BS in the allocated time slots as defined in the UL-MAP, which is constructed by the BS Uplink Scheduler and broadcast by the BS to the SSs (Nuaymi, 2007).

The WiMAX does not define the scheduling algorithm that must be implemented. Any of the known scheduling algorithms can be used: Round Robin (RR) (Ball et Al, 2006), Weighted Round Robin (WRR), Weighted Fair Queuing (WFQ), maximum Signal-to-Interference Ratio (mSIR) (Chen et Al, 2005), and Temporary Removal Scheduler (TRS) (Ball et Al, 2005).

3. WiMAX mobility

The IEEE 802.16e controls the handover, when an SS changes its current BS to a new BS within a continuous ongoing session. There are two types of handover. When the SS moves to a new BS, it stops the connection with the current BS before establishing the connection with the new BS; this procedure is also known as hard handover or break – before – make. When the SS establishes the connection with the new BS, before it stops the connection with the current BS, this procedure is called seamless handover or make – before – break (Manner, 2004).

When the SS enters the coverage area of a BS, the association process begins by obtaining the downlink parameters. The BS sends two messages to the SS (when it is inside the cell): the DL-MAP (Downlink MAP) and DCD (Downlink Channel Description). The DL-MAP message contains three elements, the physical specifications, the DCD value and the id BS. The DCD message describes the physical characteristics of the downlink channel. The next step corresponds to obtaining the uplink UCD (Uplink Channel Description) messages and UL-MAP (Uplink MAP). The UCD describes the physical characteristics of the uplink channel and the UL-MAP contains the physical specifications and also the time allocation of

resources. After the downlink and uplink parameters, the SS sends the Ranging Request (RNG-REQ) to BS to discover the link quality (signal strength, modulation), and the BS replies with the Ranging Response (RNG -RSP). Finally, the last step is the registration between SS and BS to acquire an IP address. The SS sends a Registration Request (REG-REQ) and BS replies with a Registration Response (REG-RSP).

Another important feature of the IEEE 802.16e standard is the exchange of information between neighboring BSs. The BS sends the same information to another BS in the UCD / DCD messages transmitted. The Information is exchanged on the backbone through the Mobility Neighbor Advertisement (MOB_NBH_ADV) message.

Figure 5 illustrates the handover signaling for a WiMAX network. In this scenario, the SS is initially served by/connected to the WiMAX network, but periodically the SS listens and tries out other connectivity opportunities.

1. The SS detects a new link connectivity to the WiMAX Network.
2. The Current BS sends the downlink and uplink parameter messages to the SS.
3. The SS requests information about the network by Ranging Messages
4. The SS registers in current BS by means of Registrations Messages .
5. The current BS supports the QoS flow Services.
6. The Current BS communicates with the Target BS about network information by means of Mobility Neighbor Advertisement (MOB_NBR_ADV)
7. A new link connectivity is detected and the current link goes down. The SS initiates the handover to Target BS.
8. The SS repeats steps 2, 3, 4, 5 and 6 with the Target BS

3.1 Handover policy

It is necessary to create seamless mobility schemes for Mobile WiMAX Systems to improve the handover process, while ensuring QoS and QoE support for ongoing applications. . To achieve this, an algorithm for handover policy should use two metrics: WiMAX Link failure probability and SS speed. The link failure probability means the possibility of a “break” SS connection with current BS; this value represents the signal strength obtained from the physical layer. The link failure probability P is shown in Equation 1.

$$P = \frac{(Factor \times Rxthreshold) - Avg}{(Factor \times Rxthreshold) - Rxthreshold} \quad (1)$$

Where:

Avg = average signal strength

$Factor$ = connectivity factor

$Rxthreshold$ = clear signal strength

A GPS module installed at mobile nodes is required to improve the accuracy of the system with regard to the position and speed of the mobile users, as was the case with current smart phones and laptops. As a result, it will be possible to inform the BS about position and speed issues affecting the mobile user. This involves defining three mobility profiles: high, medium and low. Each mobility profile will be associated with the precise period of time

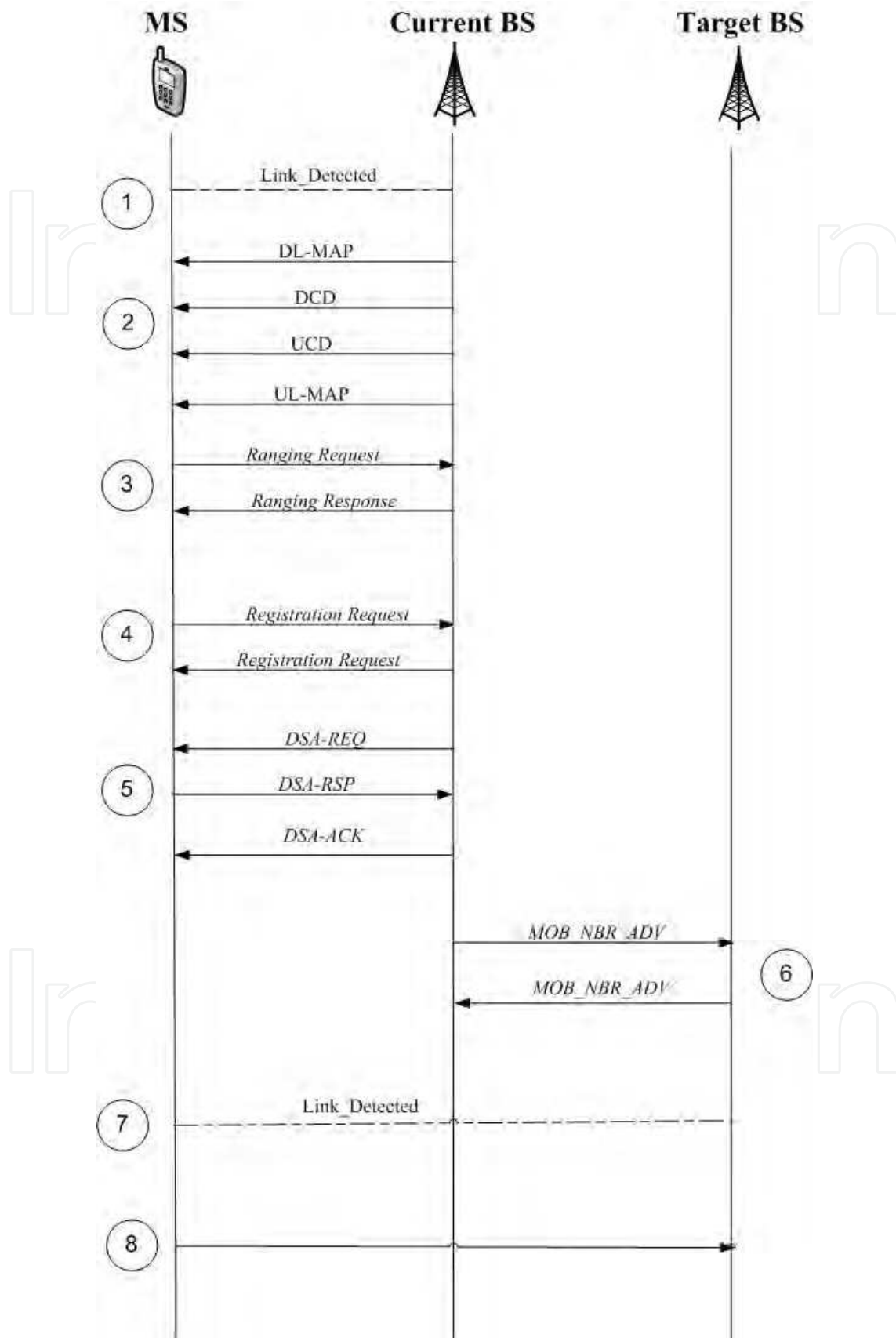

Fig. 5. The handover signaling for a WiMAX network

needed to initiate the handover. The high mobile node will remain the shortest time inside the cell, in this situation, and the handover process will be triggered before the other mobile nodes. The mobility information and link failure probability are the two components used as metrics to start the process of making a handover decision in the Mobile WiMAX architecture (Dial et Al, 2008).

1. Low mobility users (down to 7 m/s) - the handover process is initiated when the link failure probability is equal to 90%.
2. Medium mobility user (from 7 m/s and equal to 15 m/s) - the handover process is initiated when the link failure probability is equal to 70%.
3. High mobility users (from 15m/s) - the handover process is initiated when the link failure probability is equal to 50%.

When the handover process is triggered (Figure 6), the new BS sends the uplink and downlink (DL-MAP, DCD, UL-MAP, and UCD) messages to the SS. Then the SS receives a notification of the new BS with "better physical conditions" than the current BS. When the SS is in the intersection coverage (in the current and new BS), the SS can still receive packets from the current BS once it has carried out the connection process with the new BS. The SS establishes a connection with the new BS before it breaks the connection with the current BS.

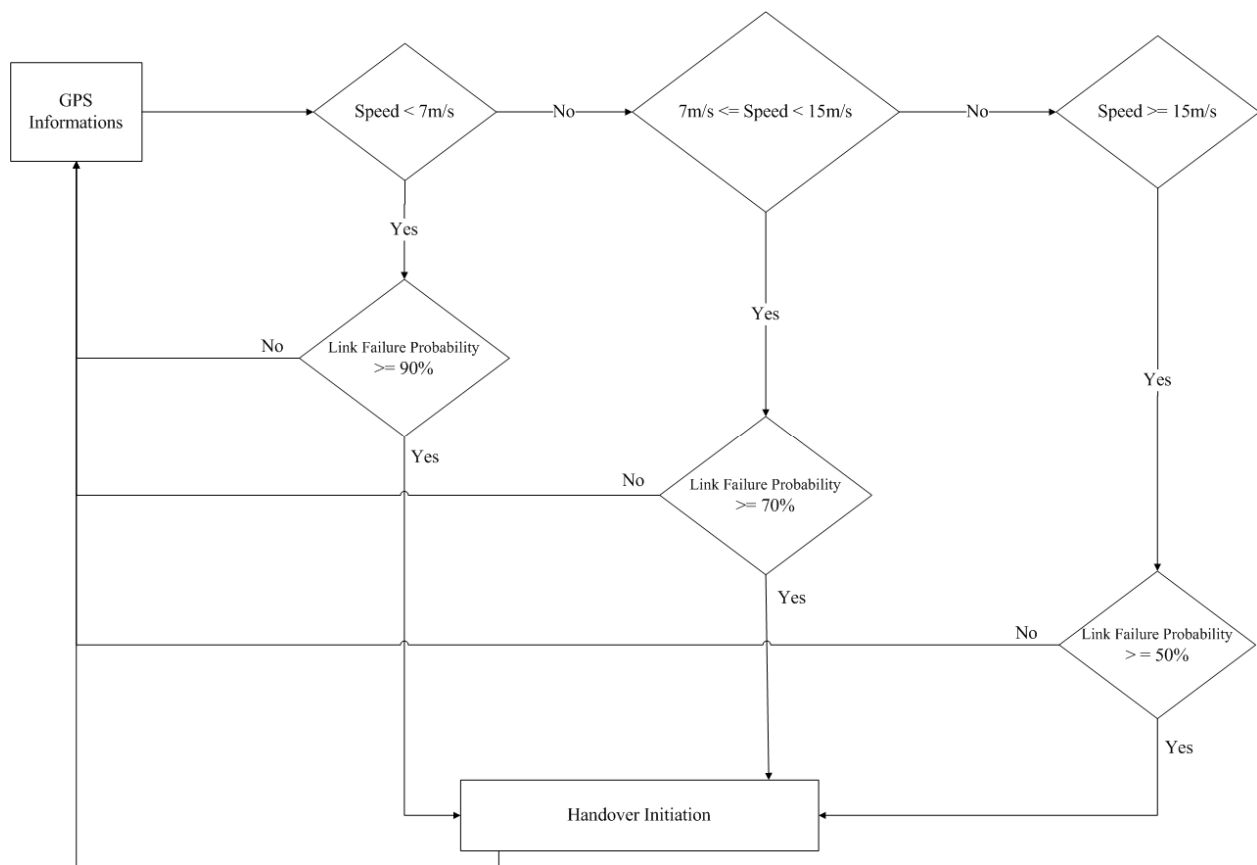

Fig. 6. Handover Policy Scheme

4. Evaluation of performance

The Simulations experiments were carried out with the aid of Network Simulator 2 to show the benefits and impact of the proposed Mobile WiMAX system in a simulated environment with all the handover policies. For the WiMAX simulations it was used a module developed by The National Institute of Standards and Technology (NIST, 2007), the module was based on the IEEE 802.16e with mobility support (Nist WiMAX, 2007). The results demonstrate the effectiveness of the architecture in supporting a seamless handover, QoS and QoE assurance. Figure 7 and Table 2 below show the topology used for the tests.

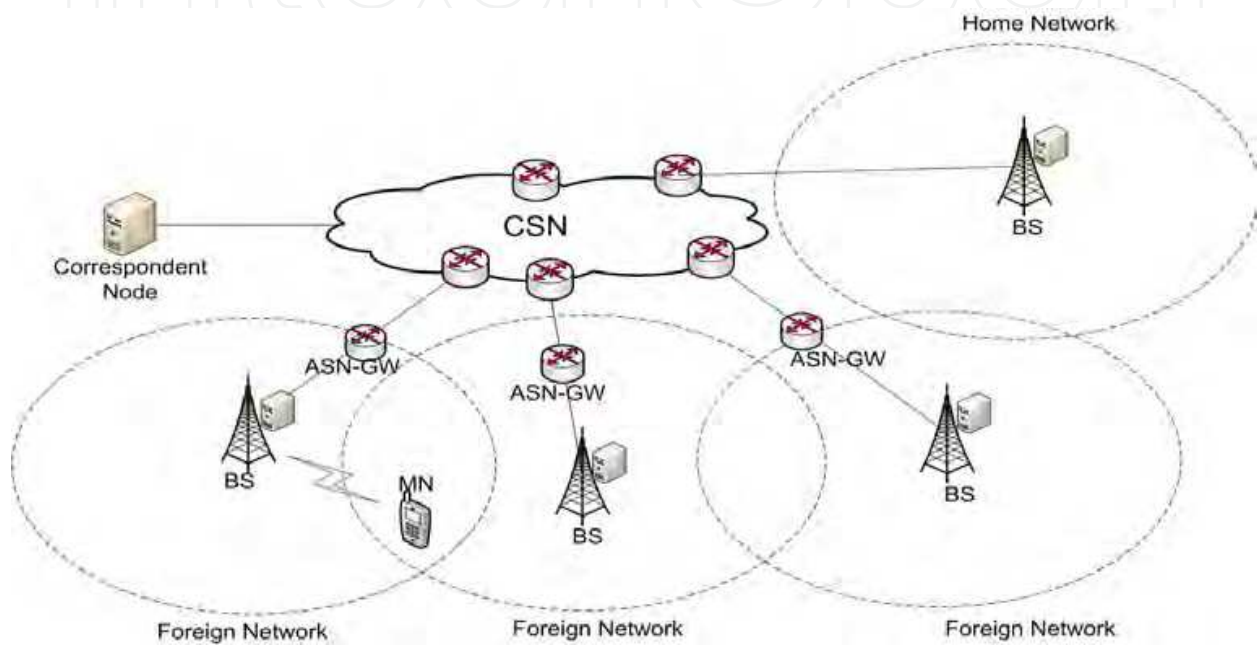

Fig. 7. Simulated Topology

Parameters		Value
Wired	Link Capacity	4 Mbps
	Link Delay	50 ms
	Buffer	50
	Queue	CBQ
WiMAX	Cover Area	1km
	Frequency	3,5GHz
	Standard	IEEE 802.16e
	Modulation	OFDM

Table 2. Simulated Parameters

4.1 CBR traffic

In the first experiment, the simulations were conducted with three mobile nodes with different mobility (low, medium and high). Due to the high mobility, the SS remains a short time inside the cell and will make three handovers. The SS with medium mobility will make two handovers and the SS with low mobility will make just one handover. The simulations were performed with CBR applications. In these simulations, the network/packet information that was measured, comprised the throughput and sequence number of packets received by each SS. Although the CBR application uses UDP as a transport protocol, we include a sequence number field to determine the losses during the handover process. For each mobility partner, a different CBR rate is used (Table 3)

Mobility	CBR application
Low	200Kbps
Medium	400Kbps
High	600Kbps

Table 3. CBR Traffic

In the first case, the simulations were performed without a handover policy. All the mobile nodes are disconnected when they change their BSs; in other words, during the handover process they break the connection with the current BSs, and after taking this step, they (re)connect with the new BS (Break - Before - Make). When the mobile nodes change their BSs, they do not receive a CBR packet application. Figure 8 and 9 below confirm this information.

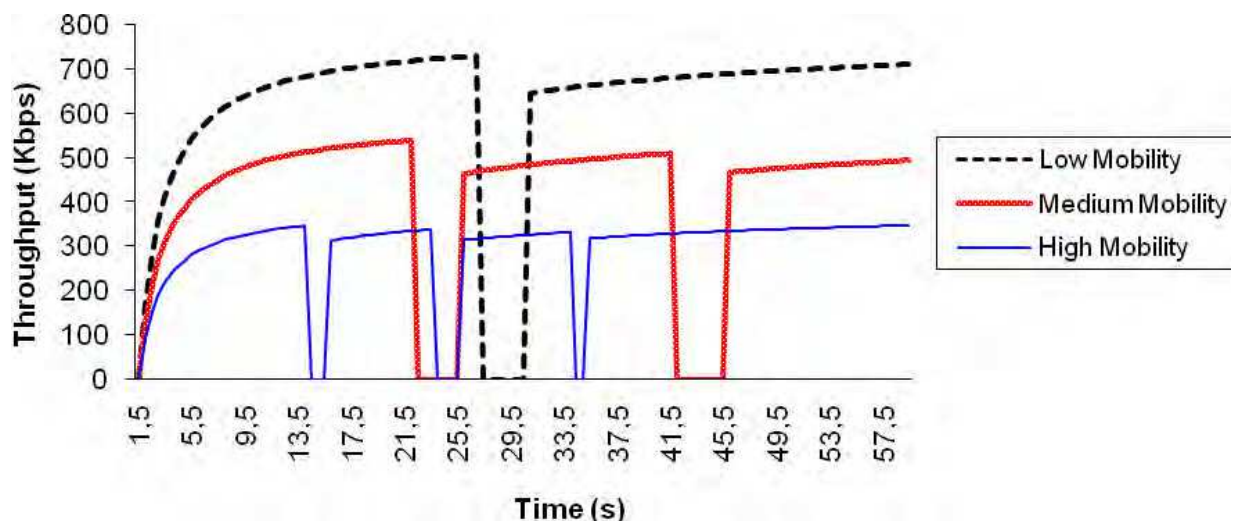

Fig. 8. Throughput without a handover policy

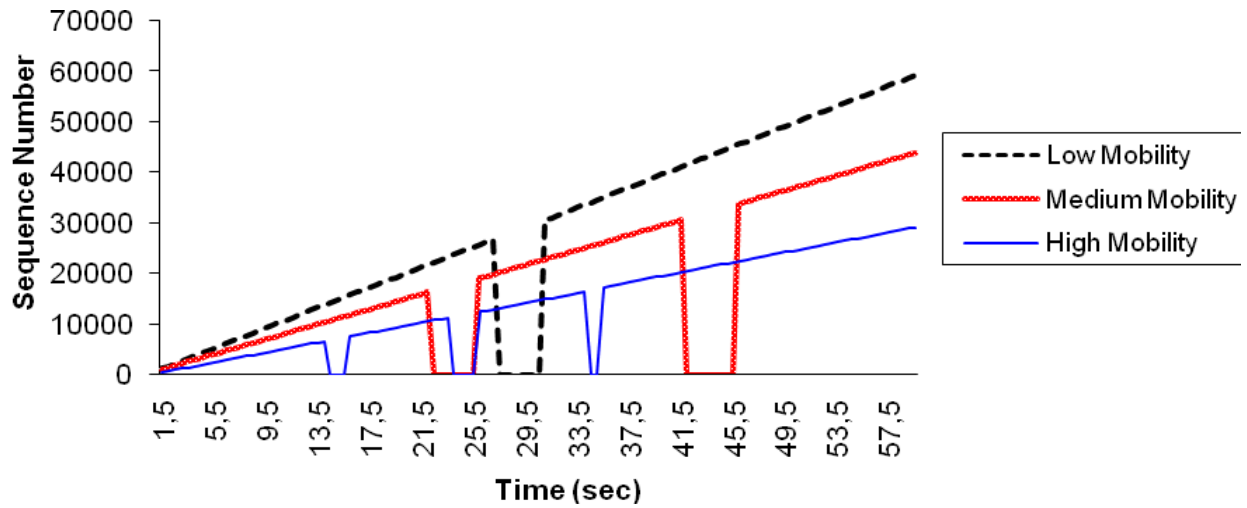

Fig. 9. Sequence Number without a handover policy

In the second case, the simulations were accomplished with the proposed handover policies. All the mobile nodes still continuously connected when they changed their BSs; in other words, during the handover process they did not break the connection with their current BSs so that they could connect with the new BS (Make - Before - Break). This meant that, the mobile nodes still received CBR packets applications during the handover. Graphs 10 and 11 below confirm this information.

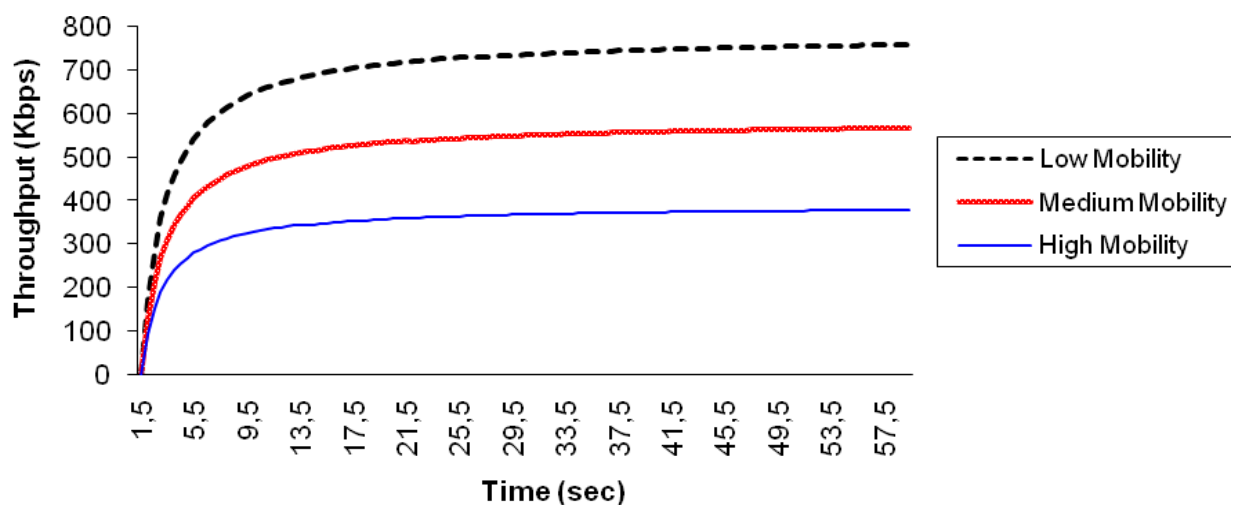

Fig. 10. Throughput with a handover policy

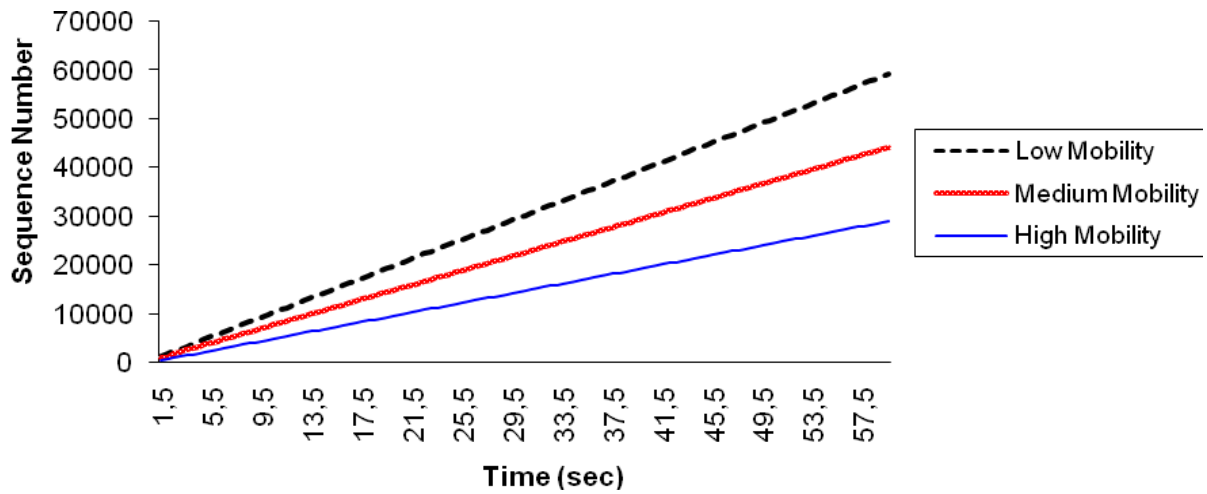

Fig. 11. Sequence Number with a handover policy

In the same scenario, by means of the Random Waypoint Mobility Model, 90 simulations were performed with the CBR application with 600kbps rate for different mobility and positions. Figure 12 shows the average throughput for each specific situation with and without a handover policy. The SSs with high speed did more handovers than others, and thus, more time should be spent without connection during the handover. In other SSs, the handover process damages the CBR application. With a handover policy, the throughput is almost constant, because the mobile nodes make a seamless handover.

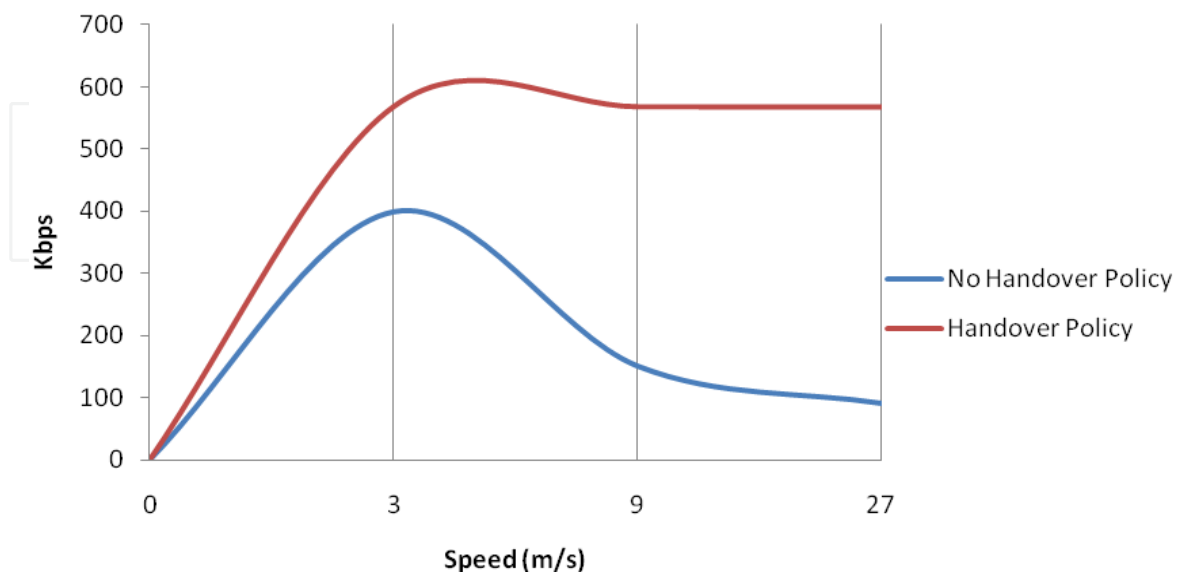

Fig. 12. Throughput x Mobility

In the simulations without the proposed handover policies, the average throughput for low, medium and high mobility were equal to 400kbps, 151kbps and 91kbps, respectively. In simulations using the handover policies, the average throughput for low, medium and high mobility were equal to 569kbps, 567kbps and 568kbps, respectively. The growth in throughput for the low mobility of the SS was 49.25 %, for its medium mobility the growth was 250% and for its high mobility was 517%. Table 4 shows the comparative values of the throughput between simulations with and without the handover policy.

Mobility	No Handover Policies	With Handover Policies	Growth
Low	400,17	569,96	49,25%
Medium	151,44	567,91	250%
High	91,7	568,04	517%

Table 4. Average Throughput

4.2 Video traffic

The simulations with video have durations of 70 seconds and during this period, the video traffic was generated by the CN and sent to the SSs in an uninterrupted form. Table 5 shows the parameters set for the video simulations.

Parameters	Value
Resolution	352 x 288
Frame Rate	30 Frame/sec
Color Scale	Y, U, V
Packet Length	1052
Packet Fragmentation	1024

Table 5. Simulation of Video Parameters

First, the simulations were performed without the handover policy. In the simulations conducted in this way, suggest that SSs are not connected during the corresponding time of the handover process and resulted in lost packets. Following this, the simulations were performed with the handover policy in the same scenarios and in the same circumstances as those of previous simulations. The SSs experienced a seamless handover, when the video

quality was maintained during the change of BS. The SS that experienced a hard handover did not receive 5% of the packets, and as a result, there was, a reduction in the quality of the video. Figure 13 compares the number of frames received for each situation.

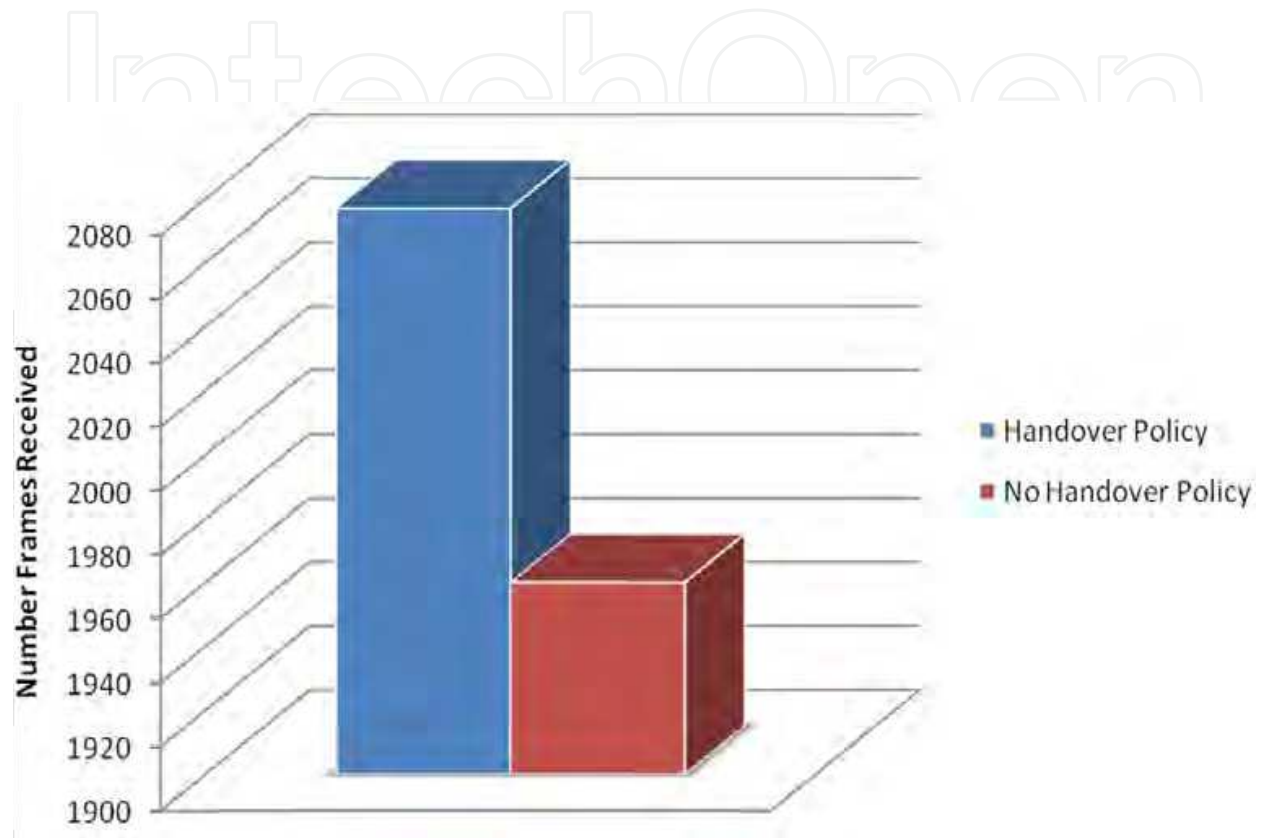

Fig. 13. Number of Decoded Frames

As well as the QoS analysis of the handover in the network architecture, we also investigated the impact of the handover on user perceptions. This was carried out by using the Evalvid tool (Evalvid, 2011) that allows control of real video quality called "Bridge (far)" or (Bridge (far) in simulations.

The benefits of the proposed solution are clear when we look at the frames in Figures 14, 15, 16 and 17. Figures 15 e 17 show frames of video received by the SS during the seamless handover. It was possible to ensure the highest video quality throughout the transmission. However, when the hard handover is experienced, the video quality is noticeably degraded. In addition, some objects in the picture are not received, as shown in Figure 14. Due to user mobility, the object containing the "bird" was not received and, thus has, not been decoded.



Fig. 14. Frame without a handover policy



Fig. 15. Frame with a handover policy

When Figure 16 and 17 are compared, it is clear that there is degradation in the quality of the frame without a handover policy.



Fig. 16. Frame degraded without a handover policy



Fig. 17. Frame with a handover policy

The QoE metrics confirm the previous statement; the video with a handover policy has 32dB PSNR. This value describes the video as "good", while the video without a handover policy has 29dB PSNR. This value describes the video as "acceptable." Figures 18 below show the similarities between the videos.

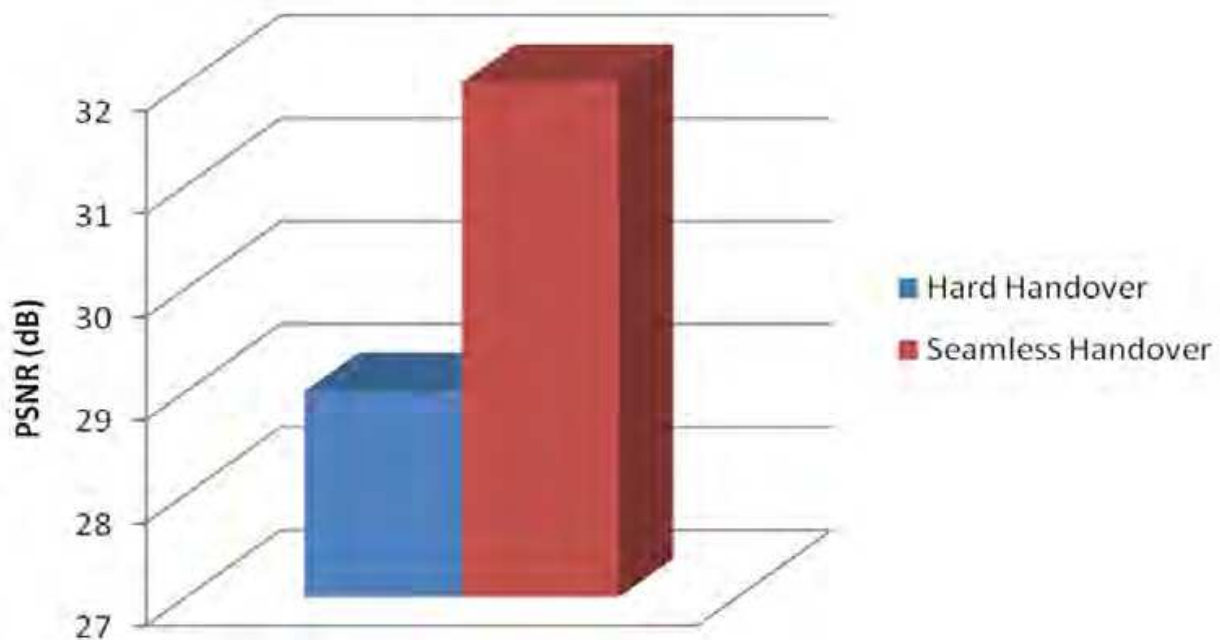

Fig. 18. Video PSNR without a handover policy x Video PSNR with a handover policy

Apart from PSNR, another metric that confirms the superiority of the video with a handover policy over the video without it, is SSIM. The value 1 means the exact same video. The SSIM for the video with seamless handover was 0.9. For the video with hard handover, the SSIM was equal to 0.7. Figures 19 below display the SSIM video.

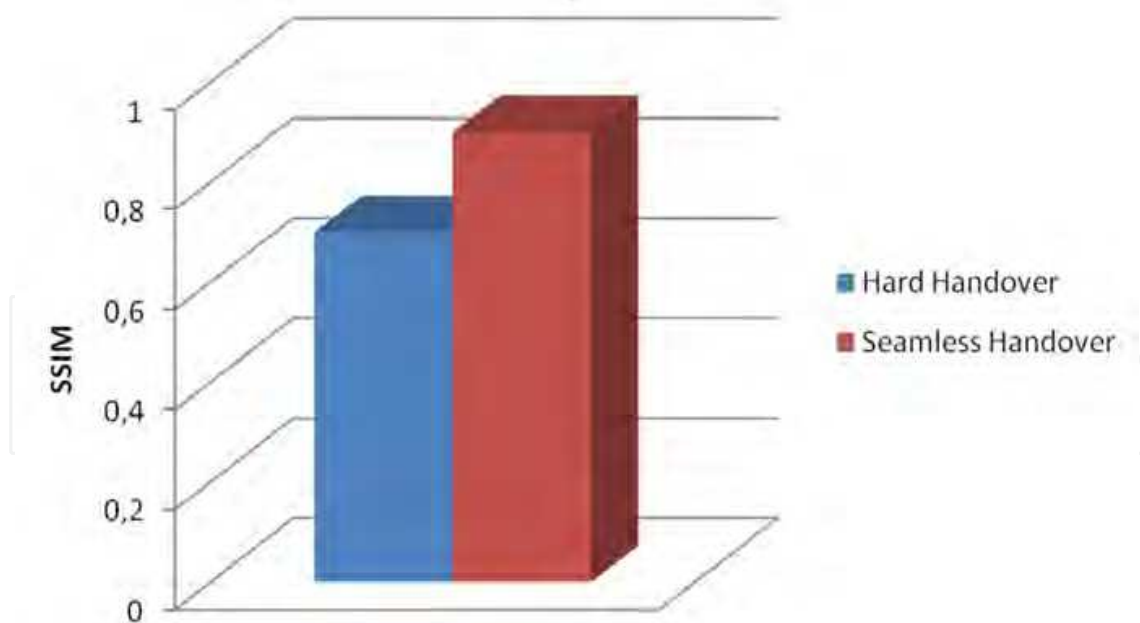

Fig. 19. Video SSIM without a handover policy x Video SSIM with a handover policy

The Video Quality Metrics are considered the most complete metrics because compare the following aspects: noise, distortion and color. In this situation, the value 0 means the exact same video. The VQM for the video with seamless handover was 1.4. For the video with hard handover, the VQM was equal to 2.6. Figures 20 below display the VQM video.

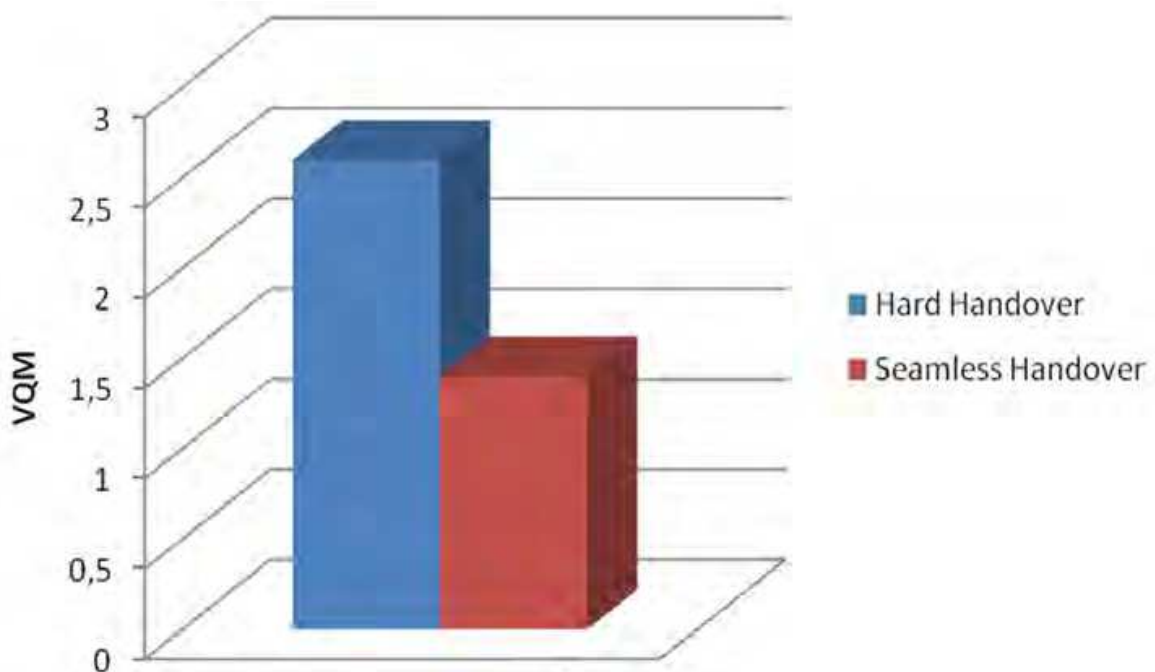

Fig. 20. Video VQM without a handover policy x Video VQM with a handover policy

5. Conclusion

In this chapter, a new architecture has been outlined that integrates the IEEE 802.16e, or as it is popularly known, the mobile WiMAX. This architecture draws on new technology and helps the handover process to provide the maximum QoS and QoE for the SS. It also includes a mobility prediction algorithm to avoid losses during the exchange of the BS. The algorithm takes account of the link quality between a mobile user and the current BS and the information about the SS received by GPS, which determines the moment when the handover should be triggered. Future work is recommended including new metrics in the algorithm, the performance of load balancing and and a plan to integrate other wireless technologies and thus form a heterogeneous architecture (e.g. the integration of WiMAX with UMTS and / or IEEE 802.11).

6. References

- IEEE 802.16e (2005) Part 16: Air Interface for Fixed and Mobile Broadband Wireless Access Systems Amendment 2: Physical and Medium Access Control Layers for Combined Fixed and Mobile Operation in Licensed Bands.
- M. Sollner, C. Gorg, K. Pentikousis, J. M. Cabero Lopez, M. Ponce de Leon, and P. Bertin (2008), "Mobility scenarios for the Future Internet: The 4WARD approach", in Proc. 11th International Symposium on Wireless Personal Multimedia Communications (WPMC), Saariselkä, Finland, September.
- Neves, P.; Matos, R.; Sousa, B.; Landi, G.; Sargento, S.; Pentikousis, K.; Curado, M.; Piri, E.; (2009), "Mobility management for NGN WiMAX: Specification and implementation," *World of Wireless, Mobile and Multimedia Networks & Workshops*,

2009. *WoWMoM 2009. IEEE International Symposium on a*, vol., no., pp.1-10, 15-19 June 2009
- Winkler S. (2005), Perceptual video quality metrics - a review, *Digital Video Image Quality and Perceptual Coding*, eds. H. R. Wu, K. R. Rao, chap. 5, CRC Press.
- ns-2 (2010) *The Network Simulator (2009)* <http://www.isi.edu/nsnam/ns/>
- Ahmet et Al (2009), "A Survey of MAC based QoS implementations for WiMAX Networks".
- Etemad, Kamran (2008). "Overview of Mobile WiMAX Technology and Evolution". *WiMAX, A Technology Update*. Intel Corporation. *IEEE Wireless Communications Magazine*, Volume 46, Pages 31-40.
- Iyer, Prakash; Natarajan, Nat; Venkatachalam, Muthaiah; Bedekar, Anand; Gonen, Eren; Etemad, Kamran; Taaghjol, Pouya; (2007) "All-IP Network Architecture for Mobile WiMAX". *IEEE Mobile WiMAX Symposium*, Digital Object Identifier: 10.1109/WiMAX.2007.348700, Pages 54-59.
- Ahmadi, Sassan. (2009) "An overview of next-generation mobile WiMAX technology". Intel Corporation. *IEEE Wireless Communications Magazine*, Volume 47, Digital Object Identifier: 10.1109/MCOM.2009.5116805, Pages 84-98, 2009.
- Vaidehi, V. Poorani, M. (2010) "Study of Handoff Performance in a Mobile WiMAX Network". *11th International Conference on Control, Automation Robotics & Vision (ICARCV)*, Digital Object Identifier: 10.1109/ICARCV.2010.5707316, Pages 2319-2324.
- L. Chrost and A. Brachman, (2010) "Towards a common benchmark in WiMAX environment", *Elsevier Computer Communications*, July.
- S.A. Ahson, M. Ilyas, (2007) "WiMAX: Standards and Security", CRC Press, Inc., Boca Raton, FL, USA.
- Y. A. Sekercioglu, M. Ivanovich and A. Yegin, (2009) "A Survey of MAC based QoS implementation for WiMAX networks", *Elsevier Computer Networks*, May.
- L. Nuaymi, (2007) "WiMAX Technology for Broadband wireless Access" John Wiley & Sons Ltd, the atrium, Southern gate, Chichester, West Sussex PO198SQ, England.
- C. F. Ball, F. Trembl, K. Ivanov, and E. Humberg. (2006) "Performance evaluation of IEEE 802.16 WiMAX with fixed and mobile subscribers in tight reuse". *European Transactions on Telecommunications*, March.
- J. Chen, W. Jiao, and Q. Guo. (2005) "An integrated QoS control architecture for IEEE 802.16 broadband wireless access systems". *Global Telecommunications Conference*, November.
- C. F. Ball, F. Trembl, X. Gaube, and A. Klein. (2005) Performance analysis of temporary removal scheduling applied to mobile WiMAX scenarios in tight frequency reuse. *European Transactions on Telecommunications*, September.
- Manner, K; (2004) "RFC 3753 - Mobility Related Terminology". June.
- Dias et al., (2008) "Approaches to Resource Reservation for Migrating Real-Time Sessions in Future Mobile Wireless Networks". Accepted for Publication in *Springer Wireless Networks (WINET) Journal*.
- Evalvid. (2011) "<http://www.tkn.tu-berlin.de/research/evalvid/>"

NIST (2007) "<http://www.nist.gov>"

NIST WiMAX (2007) "http://www.nist.gov/itl/antd/emntg/ssm_tools.cfm"

IntechOpen

IntechOpen

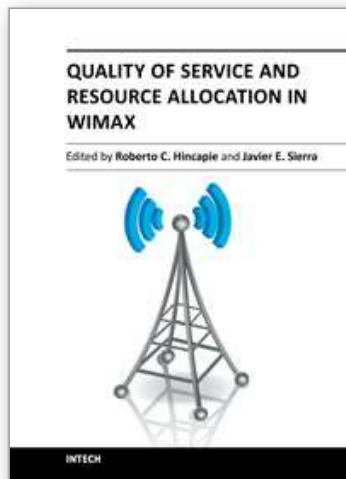

Quality of Service and Resource Allocation in WiMAX

Edited by Dr. Roberto Hincapie

ISBN 978-953-307-956-1

Hard cover, 376 pages

Publisher InTech

Published online 03, February, 2012

Published in print edition February, 2012

This book has been prepared to present state of the art on WiMAX Technology. It has been constructed with the support of many researchers around the world, working on resource allocation, quality of service and WiMAX applications. Such many different works on WiMAX, show the great worldwide importance of WiMAX as a wireless broadband access technology. This book is intended for readers interested in resource allocation and quality of service in wireless environments, which is known to be a complex problem. All chapters include both theoretical and technical information, which provides an in depth review of the most recent advances in the field for engineers and researchers, and other readers interested in WiMAX.

How to reference

In order to correctly reference this scholarly work, feel free to copy and paste the following:

José Jailton, Tássio Carvalho, Warley Valente, Renato Frânces, Antônio Abelém, Eduardo Cerqueira and Kelvin Dias (2012). A Mobile WiMAX Architecture with QoE Support for Future Multimedia Networks, Quality of Service and Resource Allocation in WiMAX, Dr. Roberto Hincapie (Ed.), ISBN: 978-953-307-956-1, InTech, Available from: <http://www.intechopen.com/books/quality-of-service-and-resource-allocation-in-wimax/a-mobile-wimax-architecture-with-qoe-support-for-the-future-multimedia-internet>

INTECH
open science | open minds

InTech Europe

University Campus STeP Ri
Slavka Krautzeka 83/A
51000 Rijeka, Croatia
Phone: +385 (51) 770 447
Fax: +385 (51) 686 166
www.intechopen.com

InTech China

Unit 405, Office Block, Hotel Equatorial Shanghai
No.65, Yan An Road (West), Shanghai, 200040, China
中国上海市延安西路65号上海国际贵都大饭店办公楼405单元
Phone: +86-21-62489820
Fax: +86-21-62489821

© 2012 The Author(s). Licensee IntechOpen. This is an open access article distributed under the terms of the [Creative Commons Attribution 3.0 License](#), which permits unrestricted use, distribution, and reproduction in any medium, provided the original work is properly cited.

IntechOpen

IntechOpen