

We are IntechOpen, the world's leading publisher of Open Access books Built by scientists, for scientists

5,500

Open access books available

134,000

International authors and editors

165M

Downloads

Our authors are among the

154

Countries delivered to

TOP 1%

most cited scientists

12.2%

Contributors from top 500 universities



WEB OF SCIENCE™

Selection of our books indexed in the Book Citation Index
in Web of Science™ Core Collection (BKCI)

Interested in publishing with us?
Contact book.department@intechopen.com

Numbers displayed above are based on latest data collected.
For more information visit www.intechopen.com



The Usefulness of Wavelet Transform to Reduce Noise in the sEMG Signal

Angkoon Phinyomark, Pornchai Phukpattaranont and Chusak Limsakul
Department of Electrical Engineering, Prince of Songkla University, Songkhla, Thailand

1. Introduction

This chapter presents a usefulness of wavelet transform (WT) algorithm in pre-processing stage of surface electromyography (sEMG) signal analysis particularly in application of noise reduction. The successful pre-processing stage based on wavelet decomposition and denoising algorithm is proposed in this chapter together with the principle, theory, up-to-date literature review and experimental results of the wavelet denoising algorithms. Main application of this algorithm is sEMG control systems, notably prosthetic devices or computers.

sEMG signal is one of the useful electrophysiological signals. It is measured by surface electrodes that are placed on the skin superimposed on the muscle. Rich useful information has occurred in the muscles subjacent to the skin as a mixture of the whole motor unit action potentials (MUAPs). Such information is also useful in a wide class of clinical and engineering researches which may lead to providing the diagnosis tools of neuromuscular and neurological problems and to providing the control systems of assistive robots and rehabilitation devices (Merletti & Parker, 2004). Generally, in order to use the sEMG as a diagnosis signal or a control signal, a feature is often extracted before performing classification stage due to a lot of information obtained from raw sEMG data and a low computational complexity required in the embedded devices (Boostani & Moradi, 2003). However, the sEMG signals that originate in a wide class of human muscles and activities are definitely contaminated by different types of noise (De Luca, 2002; Reaz et al., 2006). This becomes a main problem to extract certain features and thus the reach to high accurate classification. In the last decade, many research works have been interested in developing better algorithms and improving the existing methods to reduce noises and to estimate the useful sEMG information (De Luca et al., 2010; Mewett et al., 2004; Phinyomark et al., 2011). Generally, noises contaminated in the sEMG signal can be categorized into four major types: ambient noise, motion artifact, inherent instability of the sEMG signal, and inherence in electronic components in the detection and recording equipment (De Luca, 2002). The first three types have specific frequency band and do not fall in the energy band of the sEMG signal. For instance, power-line interference has the frequency component at 50 Hz (or 60 Hz), and motion artifact and instability in nature of sEMG signal have most of their energy in the frequency range of 0 to 20 Hz. Usage of conventional filters, i.e. band-pass filter and band-stop filter, can reduce noises in these types (De Luca et al., 2010). However, the last noise type is a central concern in analysis of the sEMG signal. It is an inherent noise that is

generated by electronic equipment. The frequency components of this noise are random in nature and range in the usable energy of sEMG frequency band from 0 to several thousand Hz. It causes difficulty in elimination using the conventional filters. Moreover, using high-quality electronic components, intelligent circuit design and construction techniques, noises can be only reduced but it cannot be entirely eliminated (De Luca, 2002). Hence, it may cause a problem in extracting the robust features (Phinyomark et al., 2008; Zardoshti-Kermani, 1995).

Wavelet transform and adaptive filter are used in advanced filtering methods that are commonly used as a powerful tool to remove random noise in non-stationary signals. Nonetheless, the drawback of adaptive filter is the complexity of devising an automatic procedure. Its performance depends on a reference input signal which is difficult to apply in the real-world applications. On the other hand, wavelet transform method does not require any reference signals. The pre-processing stage based on wavelet denoising algorithm for sEMG upper- and lower- limb movement recognitions have been a huge success over the past few years (Hussain et al., 2007, 2009; Khezri & Jahed, 2008; Phinyomark et al., 2010a, 2011; Ren et al., 2006). To achieve the best performance in wavelet denoising algorithm, five wavelet parameters must be addressed. Hence, in this chapter, we have evaluated all wavelet denoising parameters for improving the classification performance of sEMG control systems. As a result, the improvement of classification accuracy of the sEMG recognition system has been presented and a robustness of the system has also been improved.

The rest of this chapter is as follows: Section 2 presents various types of electrical noises in sEMG signals and discusses how to simulate these artificial noises. In Section 3, principle and theory of wavelet transform algorithm in both general and denoising viewpoints are described. Extensive review and careful survey of up-to-date wavelet denoising methods in numerous biomedical signals and applications are summarized in Section 4 and recent trend of wavelet denoising algorithms in the sEMG signal analysis is discussed in Section 5. In Section 6, the experimental results of using wavelet denoising algorithms with real sEMG signals are presented and discussed. Lastly, conclusion and future trends of using wavelet transform to reduce noise in the sEMG signal are proposed in Section 7.

2. Electrical noises in the SEMG signal

2.1 Different types of the noises

Noises contaminated in the sEMG signal can be categorized into four main types: ambient noise, motion artifact, sEMG signal inherent instability, and inherence in electronic components in the detection and recording equipments (De Luca, 2002; Kale & Dudul, 2009; Reaz et al., 2006). More details about source and characteristics of each noise type are explained in the following discussion:

1. Ambient noise: This kind of noise originates from electromagnetic radiation sources such as electrical-power wires, light bulbs, fluorescent lamps, radio and television transmission, computers, etc. Essentially any electromagnetic device or device that is plugged into the A/C power supply generates and may contribute ambient noises. Moreover, our body surfaces are persistently flooded with electric-magnetic radiation and it is practically impossible to avoid exposure to it on the surface of the earth. The dominant frequency of the ambient noise arises from the 50 Hz (or 60 Hz) radiation from power sources. Generally, the main concern noise in this type is also called "Power-line noise or 50 Hz interference". The amplitude of the ambient noise is one to

three orders of magnitude greater than the sEMG signal. Therefore, in analysis of the sEMG signal in various research works have implemented a notch filter (band-stop filter) at this frequency (Mewett et al., 2004). Theoretically, this type of filter would only remove the unwanted power-line frequency; however, practical implementations also remove portions of the adjacent frequency components. Because the dominant energy of the sEMG signal is located in the 50-100 Hz range, the use of notch filter is not advisable (De Luca, 2002). One of our previous studies (Phinyomark et al., 2009a), the effect of this kind of noises with the sEMG feature extraction was investigated. The robust features for this kind of noise, notably Willison amplitude, have been found in order to avoid the implementing a notch-filter.

2. Motion artifact: This kind of noise causes irregularities in the signal. When motion artifact is putted into the data, the sEMG information may be skewed. There are two main sources of motion artifact: 1) the interface between the detection surface of electrode and skin 2) the movement of the cable connecting electrode to the amplifier. The dominant energy of the electrode motion artifact has been concerned in the frequency range from 0 to 20 Hz. The second type of noise source, cable motion artifact typically has a frequency range of 1 to 50 Hz. However, both of these sources can be essentially reduced by proper design of the electronics circuitry and set-up. Moreover, some research works suggest implementing a high-pass filter into the measurement instrumentation with a corner frequency of 10 Hz (Clancy et al., 2002) or 20 Hz (De Luca et al., 2010).
3. sEMG signal inherent instability: Amplitude of the sEMG signal is quasi-random in nature. This kind of noise is affected by the random in nature of the firing rate of the motor units which, in most conditions, fire in the frequency components between 0 and 20 Hz. Because of the unstable nature of these components of the sEMG signal, it is advisable to consider them as unwanted noise and remove them from the sEMG signal. Nevertheless, it can be removed using a high-pass filter with a cut-off frequency of 20 Hz which has already been implemented in the removing of motion artifact.
4. Inherence in electronic components in the detection and recording equipments: All electronics equipments generate electrical noise. This noise has the frequency components that range from 0 Hz to several thousand Hz. The problem is that this kind of noise cannot be eliminated. It can only be reduced by using high-quality electronic components, intelligent circuit design and construction techniques. Therefore, this kind of noise is becoming a major problem in analysis of the sEMG signal. Our previous studies, we have paid more interest in reducing the effect of noise in this group (Phinyomark et al., 2008, 2009b, 2009c, 2009d, 2009e, 2009f, 2009g, 2009h, 2010a, 2010b, 2010c, 2011).

Note that during the recording of the sEMG signal, the subject is generally instructed to relax. However, regardless of relaxation, muscles always show a basic level of electrical activity. It has been suggested that this residual sEMG activity may establish a significant part of the total noise level (Huigen et al., 2002). All of these noises also mentioned to the background noise.

2.2 Simulation of noises in sEMG signal analysis

From the above explanation, we can notice that first three types of noises have the specific frequency band and do not fall in the dominant energy band of the sEMG signal. Thus

usage of the conventional filters such as band-pass filter, high-pass filter and notch filter can eliminate noises in this group (De Luca et al., 2010). However, noise of the last type is a main concern in analysis of the sEMG signal. It ranges in the usable energy of sEMG frequency band from 0 to several thousand Hz; therefore, it causes difficulty in elimination using the conventional filters. Moreover, using high-quality electronic components, intelligent circuit design and construction techniques, noise in this group can be only reduced but it cannot be entirely eliminated (De Luca, 2002; Kale & Dudul, 2009; Reaz et al., 2006).

To prepare the noisy sEMG signals, random noise is considered to be used as a representative noise, an agent of the fourth noise type. Usually, white Gaussian noise (WGN) is used as a representative random noise in the sEMG signal analysis (Boostani & Moradi, 2003; Kale & Dudul, 2009; Laterza & Olmo, 1997; Law et al., 2011; Wellig & Moschytz, 1998; Zardoshti-Kermani et al., 1995). This noise is also called artificial random noise or simulated random noise. The WGN is a random signal with a flat power spectral density and a normal amplitude distribution. To more clearly understand, the flat power spectral density means that the signal contains equal power within a fixed bandwidth at any center frequency and the normal amplitude distribution means that the signal contains random values that tend to cluster around a single mean value. Usually the WGN is set to a zero mean and a unit standard deviation (Kale & Dudul, 2009; Phinyomark et al., 2009c, 2010a, 2011). In order to evaluate performance of the denoising algorithms, different levels of the WGN are used in the preparation of noisy environment. Zardoshti-Kermani et al. (1995) estimated the WGN with root-mean-square (RMS) amplitude on each muscle position varying from 0% to 50% of the overall average RMS amplitude of the whole muscle activities. The estimated signal-to-noise ratios (SNRs) were varied from 1:3 to 7:1 which depended on level of muscle contraction. Subsequently, Andrade et al. (2006) and Law et al. (2011) estimated the WGN with amplitude ranging from 20% to 100% and from 2% to 40% of the absolute maximum amplitude, respectively. On the other hand, Boostani and Moradi (2003) estimated the WGN with one tenth of the peak-to-peak amplitude range of the sEMG signal. In our previous studies, noisy sEMG signals were simulated by adding synthetic WGNs which resulted in different SNRs. The SNRs ranged from 20 dB (low noise level) to 0 dB (high noise level) with the increasing step of 5 dB SNR (Phinyomark et al., 2009c, 2010a, 2011). In addition, some research studies have used our criterion for simulated noisy EMG environments; for instance, Huang et al. (2010) designed a robust EMG sensing interface for pattern classification by using the simulated WGN in range of 20-0 dB SNRs.

Other three important types of noises that normally are used and considered in the simulated noisy EMG environment are power-line noise, movement artifact, and baseline noise. Firstly, power-line interference is used to evaluate ability of both denoising algorithms and robust sEMG features (Boostani & Moradi, 2003; Phinyomark et al., 2009a). This kind of noise is easy to simulate because its frequency component appears at only one frequency point, 50 or 60 Hz. Secondly, movement artifact can be estimated by the volunteer movement which can be monitored by using an accelerometer sensor (De Luca et al., 2010). The accelerometers were attached in the proximity of the sEMG sensors, such as on the top or the distal. When the subjects move their muscles and a movement at the electrode-skin interface is occurred, the g value from the accelerometer can be shown that event (De Luca et al., 2010). Thirdly, noise that is considered in analysis of the sEMG signal is baseline noise. However, this kind of noise can be problematic only when the sEMG signal is very low SNR (Clancy et al., 2002) such as in the assessment of antagonist muscle co-activation or in the classification of low-level muscle contraction (Baratta et al., 1998; Law et al., 2011).

3. Principle and theory of wavelet transform in denoising viewpoint

3.1 Wavelet decomposition

Wavelet transform (WT) is a time-scale representation technique, which expresses a signal into a two-dimensional function of time and scale (pseudo-frequency). The WT uses the correlation with translation and dilation of a wavelet function to yield this transformation. It represents a signal as a sum of wavelets with different locations and scales that allows to use long time intervals for low-frequency information and to use shorter regions for high-frequency information. The WT can be categorized into two main types: continuous wavelet transform (CWT) and discrete wavelet transform (DWT). Calculating wavelet coefficients at every possible scale as implemented in CWT is a fair amount work and it generates an awful lot of data. Usually in denoising viewpoint, the researchers obtain such an analysis from DWT. The definition of DWT is given by:

$$C(a,b) = \sum_{n \in \mathbb{Z}} x(n)g_{j,k}(n) \quad (1)$$

where $C(a,b)$ are dyadic wavelet coefficients, a is dilation or scale ($a=2^j$), b is translation ($b=k \times 2^j$), $x(n)$ is the input signal, and $g_{j,k}(n)$ is discrete wavelet ($g_{j,k}(n)=2^{j/2} \times g(2^j n - k)$ where $j \in \mathbb{N}$ and $k \in \mathbb{Z}$). When the input signal is decomposed to a certain level using the DWT, a set of wavelet coefficients is correlated to the high-frequency components (low-scale) while the other wavelet coefficients are correlated to low-frequency components (high-scale). In details, as shown in Fig. 1, in the first step, the original signal (S) is passed through two complementary filters, a low-pass filter and a high-pass filter, and emerges as two signals, approximations and details. The first-level approximation coefficient array (cA1) is obtained from a low-pass filter which includes down-sampling and the first-level detail coefficient array (cD1) is passed through a high-pass filter with down-sampling. The low-pass and high-pass filtering processes are similar to convolving the signal with a scaling function and a wavelet function, respectively. For many signals, generally, the low-frequency content (cA) is the most important part and the high-frequency content (cD), on the other hand, impacts flavor or nuance (noises). Hence, the second-level approximation coefficient array (cA2) and the second-level detail coefficient array (cD2) are obtained by inputting the cA1 into the filters. This is similar to dilating the original scaling function and wavelet function prior to convolving with the cA1. The process is repeated until the desired final level approximation and detail coefficient arrays are obtained. As shown in Fig. 1, it has 3 decomposition levels. When the decomposition is taken as a whole, the denoising process can be employed. If any modification process is not required, the reconstruction process will be instantaneously done. The reconstructed signal (S'), final level approximation and all level details, are true components of the original signal. This is called the perfect reconstruction. The reconstruction process is performed by up-sampling each coefficient array prior to refiltering.

The DWT provides a great advantage over the Fourier analysis and the short-time Fourier transform (STFT) analysis. Although the traditional Fourier analysis performs greatly for the stationary signals, it has a serious drawback if the interesting signals contain non-stationary or transitory characteristics. The STFT and the DWT, on the other hand, map a signal into a two-dimensional function of time and frequency by using a windowing technique. Both of them thus perform greatly for the non-stationary signals. The DWT shares some similarities to the STFT as we described above, except that the fixed window size in the STFT is no more flexible for many signals.

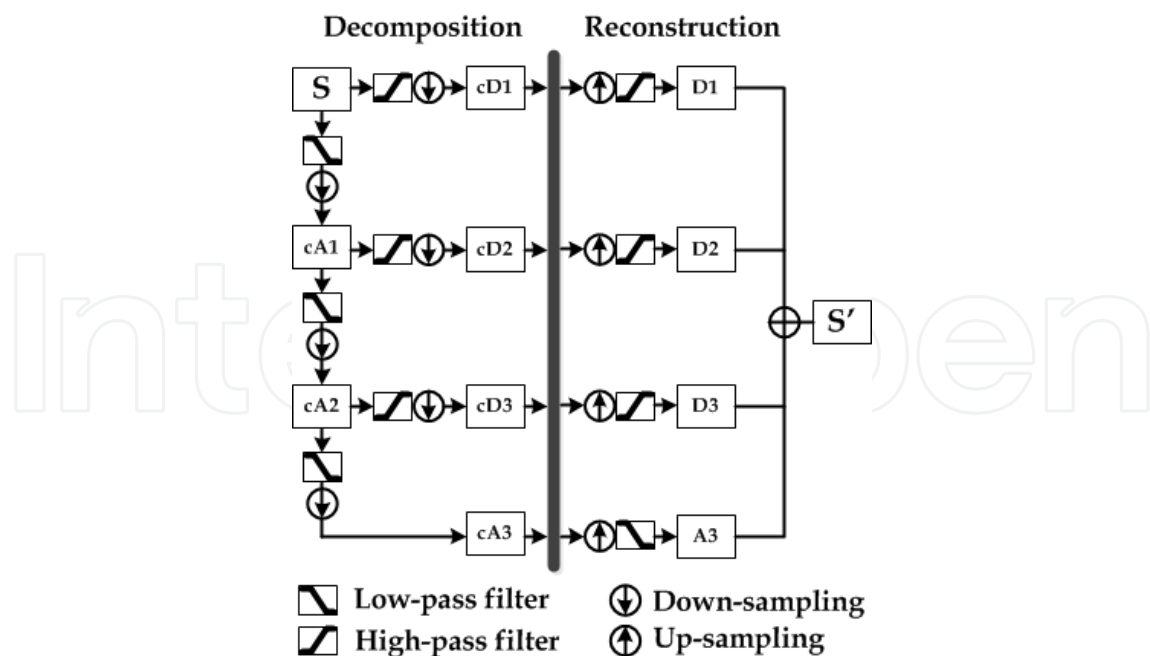

Fig. 1. Wavelet decomposition and reconstruction process.

3.2 Wavelet denoising

The undesired wavelet coefficients containing random noise can be discarded before performing the reconstruction process. The cleaner signal will be obtained from that process. To grab this outcome, thresholding is used in wavelet domain to remove or to shrink some coefficients of DWT detail sub-signals of the measured signal. Usually, the denoising method that applies thresholding in wavelet domain has been proposed by Donoho (1995). The Donoho's method for noise reduction works well for a wide class of one-dimensional and two-dimensional signals. The basic idea of wavelet-based denoising procedure is illustrated in Fig. 2. It consists of three main steps: decomposition, modification of detail coefficients and reconstruction. The first and the last main steps are the general DWT procedure as we described in the Section 3.1. The middle main step is added into the general DWT procedure that involves three parameters: threshold selection rule, threshold rescaling method and thresholding function. In other words, two main points must be addressed: how to choose the threshold value and how to perform the thresholding. In addition, two parameters in decomposition step must be evaluated that are wavelet function and decomposition level.

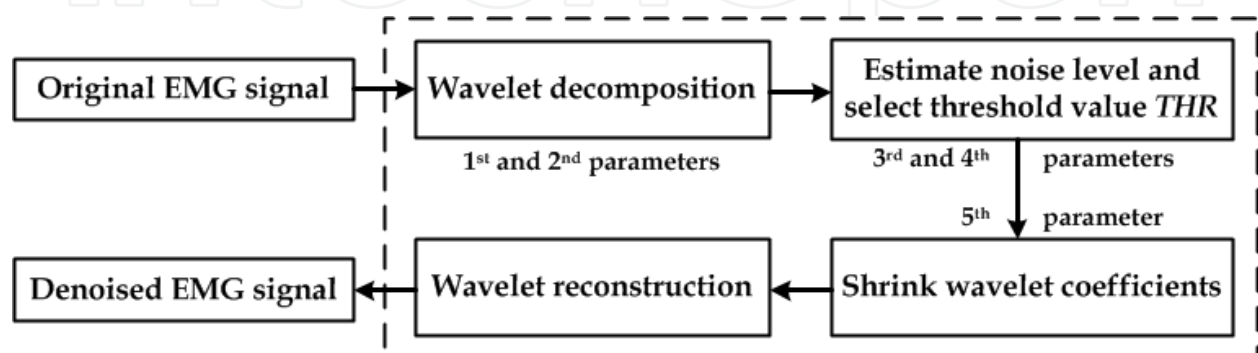

Fig. 2. Wavelet denoising procedure.

In details, the first step in producing a wavelet denoising is to choose a wavelet function (first parameter) to be used in signal decomposition. Different types of wavelet are available which each type has different sub-types. The second step, the selection of a suitable decomposition level (second parameter) must be selected with a candidate wavelet function. The third step, the threshold value THR (third parameter) to be applied in the wavelet domain is calculated by the product of the standard deviation of the noise energy σ and the small factor that depends on the length N of the data sample (Donoho and Johnstone, 1994). There are many modified versions of threshold selection rule. In order to rescale the threshold value THR obtained from the third step; the estimation of the noise energy σ (fourth parameter) is specified in this step. The fifth step, after threshold THR is smoothed, the thresholding is based on a threshold value THR which is used to compare with all the detailed coefficients. Ordinarily, two types of thresholding functions (fifth parameter) are often used: hard thresholding and soft thresholding (Donoho and Johnstone, 1994). The choice of threshold values and thresholding functions plays an important role in the global performance of a wavelet processor for noise reduction. Wavelet-based denoising algorithm is based on the underlying model. It is basically of the following form:

$$s(n) = x(n) + \sigma e(n), \quad (2)$$

where $s(n)$ is the measured or noisy signal, $x(n)$ is the original or clean signal and $e(n)$ is a Gaussian white noise $N(0,1)$, σ is the strength of the noise, and time n is equally spaced.

4. Review and theory of modified wavelet denoising methods

From the last section, the application of wavelet-based denoising algorithm requires the selection of five processing parameters named “wavelet denoising parameters”, including: (1) the type of wavelet basis function, (2) the decomposition level, (3) threshold selection rule (4) threshold rescaling method, and (5) thresholding function. Throughout the extensive review and careful survey of up-to-date wavelet denoising methods in a wide class of biomedical signals and applications, theory and definition of all methods are summarized in the following.

4.1 Wavelet basis functions

Wavelet function or mother wavelet can be categorised into two main types: orthogonal and biorthogonal wavelets. Orthogonal wavelet is entirely defined by the scaling filter (a low-pass finite impulse response (FIR) filter). For analysis with this wavelet, the high-pass filters are calculated as the quadrature mirror filter of the low-pass filters and reconstruction filters are defined as the time reverse of the decomposition filters. In biorthogonal wavelet, decomposition and reconstruction filters are defined as the separate filters. Commonly, there are 6 wavelet families: Daubechies wavelets (10 sub-types), Symlets wavelets (7 sub-types), Coiflet wavelets (5 sub-types), BiorSplines wavelets (15 sub-types), ReverseBior wavelets (15 sub-types) and Discrete Meyer wavelet. All of wavelet functions are presented in Table I. It is important for choosing the right wavelet function (Kania et al., 2007; Tan et al., 2007). The right filter determines perfect reconstruction and performs better analysis.

Wavelet family	Wavelet subtypes
Daubechies	db1 or haar, db2, db3, db4, db5, db6, db7, db8, db9, db10
Symlets	sym2, sym3, sym4, sym5, sym6, sym7, sym8
Coiflet	coif1, coif2, coif3, coif4, coif5
BiorSplines	bior1.1, bior1.3, bior1.5, bior2.2, bior2.4, bior2.6, bior2.8, bior3.1, bior3.3, bior3.5, bior3.7, bior3.9, bior4.4, bior5.5, bior6.8
ReverseBior	rbio1.1, rbio1.3, rbio1.5, rbio2.2, rbio2.4, rbio2.6, rbio2.8, rbio3.1, rbio3.3, rbio3.5, rbio3.7, rbio3.9, rbio4.4, rbio5.5, rbio6.8
Discrete Meyer	dmey

Table 1. List of 53 wavelet functions from 6 wavelet families.

4.2 Decomposition levels

Next step is the selection of the number of decomposition level of the signal. The decomposition level can be varied from 1 (the first level of decomposition) to $J=\log_2N$ (the maximum depth of decomposition) where N is the length in samples of time-domain signal.

4.3 Threshold selection rules

Threshold selection rule refers to “how to choose the threshold value”. Generally, most of research works have used universal threshold selection rule proposed by Donoho. It has been shown that its denoising capability is better than other classical methods such as SURE method, Hybrid method, and minimax method (Phinyomark et al., 2009f). The definition and description of four mainly threshold selection rules are summarized in Table 2. Hence, in our studies, we have interested in numerous modified versions of universal rule (rule 1 in Table 2). Six modified universal rules have been proposed as described in the following. In this chapter, we provide the specific name to each rule as follows.

Thresholding rule	Description
Rule 1: Universal	It uses a fixed form threshold (Donoho & Johnstone, 1994) which can be defined as $THR_{UNI} = \sigma\sqrt{2\log(N)}$, where N is the length in samples of time-domain signal and σ is standard deviation of noise. The parameter σ can be estimated using median parameter which can be calculated as $\sigma = \text{median}(cD_j)/0.6745$ where cD_j is the detail wavelet coefficients at scale level j and 0.6745 is a normalization factor.
Rule 2: SURE	Threshold is selected using the rule of Stein’s Unbiased Estimate of Risk (SURE). It gets an estimate of the risk for a particular threshold THR , where risk is defined by SURE (Stein, 1981). Minimizing the risk in THR gives a selection of the threshold.
Rule 3: Hybrid	This rule attempts to overcome limitation of SURE. It is a mixture of the universal and the SURE rules. The exact conditions of this algorithm are described in Donoho and Johnstone (1995).
Rule 4: Minimax	This method was also proposed in Stein (1981) work. It used a fixed threshold chosen to yield minimax performance for mean square error against an ideal procedure.

Table 2. Four main threshold selection rules.

1) Length Modified Universal rule (LMU): It was modified by Donoho to be used with soft-thresholding function (Donoho, 1995). It is defined as

$$THR_{LMU} = \frac{\sigma\sqrt{2\log(N)}}{\sqrt{N}}. \quad (3)$$

2) Scale Modified Universal rule (SMU): It was modified by Donoho to be used with level dependent method (Donoho, 1992). It can be expressed as

$$THR_{SMU} = \sigma\sqrt{2\log(N)} \cdot 2^{\frac{j-J}{2}}, \quad (4)$$

where j is scale level from 1 to J and J is the maximum level.

3) Global Scale Modified Universal rule (GSMU): It was modified by Zhong and Cherkassky (2000) to be used in denoising of image. It is given by

$$THR_{GSMU} = \sigma\sqrt{2\log(N)} \cdot 2^{\frac{-j}{2}}. \quad (5)$$

4) Scale Length Modified Universal rule (SLMU): It was modified by Donoho (1992). It is a combination between LMU and SMU rules. It is shown as

$$THR_{SLMU} = \frac{2\sigma\sqrt{2\log(N)}}{\sqrt{N} \cdot 2^{\frac{J-j}{2}}}. \quad (6)$$

5) Log Scale Modified Universal rule (LSMU): It was modified by Song and Zhao (2001). It takes the different thresholds at different scales. It can be defined as

$$THR_{LSMU} = \frac{\sigma\sqrt{2\log(N)}}{\log(j+1)}. \quad (7)$$

6) Log Variable Modified Universal rule (LVMU): It was modified by Zhang and Luo (2006). It uses the constant d to adapt the value of threshold THR . Experiment of Zhang and Luo (2006) showed that the constant d is associated to the wavelet function and the SNR. It should be ranging between 0 and 3. In our study, we used $d = 3$. The equation can be defined as

$$THR_{LVMU} = \frac{\sigma\sqrt{2\log(N)}}{\log[e + (j-1)^d]}. \quad (8)$$

4.4 Threshold rescaling methods

All threshold selection rules can be smoothing their thresholds by using rescaling methods. In threshold rescaling, three categories can be identified: global (GL), first-level (FL) and level dependent (LD) (Elena et al., 2006; Johnstone & Silverman, 1997). In the first one, standard deviation of noise (σ) can be adapted to three categories (GL, FL and LD). While the second one, length of wavelet coefficients (N) can be adapted to only GL and LD

thresholding. To identify the threshold rescaling methods, GL defines σ as the estimated standard deviation of all wavelet coefficients and N as the length of the total wavelet coefficients. FL defines σ_1 as the estimated standard deviation of the first-level detail coefficients (cD_1). LD defines σ_j as the estimated standard deviation for every possible decomposition levels and N_j as the length of the wavelet coefficients at decomposition level j .

4.5 Thresholding functions

After threshold values are determined, shrinking can be done using wavelet thresholding functions. In this chapter, after extensive review of the available literatures, fifteen wavelet thresholding functions were described in the following.

1) Hard function (HAD): It is the simplest function. All wavelet's detail coefficients whose absolute values are lower than threshold are set to be zero and other wavelet's detail coefficients are kept (Donoho & Johnstone, 1994). It is defined as

$$cD_j = \begin{cases} cD_j, & \text{if } |cD_j| > THR_j \\ 0, & \text{otherwise} \end{cases} \quad (9)$$

2) Soft function (SOF): It is an expanded version of HAD (Donoho & Johnstone, 1994). It can be done by first zeroing all wavelet's detail coefficients whose absolute values are lower than threshold same as HAD. Then, non-zero coefficients are shrunk towards zero. SOF function is determined by

$$cD_j = \begin{cases} \text{sgn}(cD_j)(|cD_j| - THR_j), & \text{if } |cD_j| > THR_j \\ 0, & \text{otherwise} \end{cases} \quad (10)$$

where $\text{sgn}(x)$ is a sign function that extracts the sign of a real number x .

3) Mid function (MID): It is an extension of SOF (Percival & Walden, 2000), small wavelet's coefficients are zeroed, and then large wavelet's coefficients are not affected. However, intermediate wavelet's coefficients are reduced. MID function can be expressed as

$$cD_j = \begin{cases} cD_j, & |cD_j| > 2THR_j \\ 2\text{sgn}(cD_j)(|cD_j| - THR_j), & THR_j < |cD_j| \leq 2THR_j \\ 0, & \text{otherwise} \end{cases} \quad (11)$$

4) Hyperbolic function (HYP): It is attempted to address the limitation of SOF. It is described in Vidakovic (1999) work and its equation is defined same as modulus squared function (Guoxiang & Ruizhen, 2001) that is given by

$$cD_j = \begin{cases} \text{sgn}(cD_j)\sqrt{(cD_j^2 - THR^2)}, & \text{if } |cD_j| > THR \\ 0, & \text{otherwise} \end{cases} \quad (12)$$

5) Modified hyperbolic function (MHP): It combines the advantage of HAD and SOF functions. It resembles the variance pattern of HAD and the removing of bias problem of SOF. It is modified by Poornachandra et al. (2005) and is shown as

$$cD_j = \begin{cases} (k \cdot cD_j) \left[1 + \left(\frac{cD_j^2}{6} \right) \right], & \text{if } |cD_j| > THR_j \\ 0, & \text{otherwise} \end{cases}, \quad (13)$$

where k is the scaling function and, in our studies, we used 1 for the constant k .

6) Non-negative Garrote function (NNG): It combines Donoho and Johnstone's thresholding function with Breiman's NNG. The equation is modified by Gao (1998) as

$$cD_j = \begin{cases} cD_j - \frac{THR_j^2}{cD_j}, & \text{if } |cD_j| > THR_j \\ 0, & \text{otherwise} \end{cases}. \quad (14)$$

7) Compromising of HAD and SOF function (CHS): It estimates wavelet's coefficients by weighted average of HAD and SOF (Guoxiang & Ruizhen, 2001). For $0 < a < 1$, when a is 0, it changed into HAD and when a is 1, it changed into SOF. In our study, we used 0.5 for the constant a . It can be expressed as

$$cD_j = \begin{cases} \text{sgn}(cD_j)(|cD_j| - \alpha THR_j), & \text{if } |cD_j| > THR_j \\ 0, & \text{otherwise} \end{cases}. \quad (15)$$

8) Weighted Averaging function (WAV): It estimates coefficients by weighted average of HYP and HAD (Zhang & Luo, 2006). It is given by

$$cD_j = \begin{cases} (1 - \alpha) \text{sgn}(cD_j) \sqrt{(cD_j^2 - THR_j^2)} + \alpha(cD_j), & \text{if } |cD_j| > THR_j \\ 0, & \text{otherwise} \end{cases}, \quad (16)$$

where $0 < a < 1$. If a is 0, Eq. (16) will change to HYP and Eq. (16) will change to HAD, if a is 1. We used 0.5 for the constant a .

9) Adaptive Denoising function (ADP): It is modified based on SOF (Tianshu et al., 2002). It is given by

$$cD_j = cD_j - THR_j + \frac{2THR_j}{1 + e^{2.1cD_j/THR_j}}. \quad (17)$$

10) Improved function (IMP): It is attempted to address the deficiency of HAD and SOF (Su & Zhao, 2005). It can be defined as

$$cD_j = \begin{cases} \text{sgn}(cD_j)(|cD_j| - \beta^{(THR_j - |cD_j|)} \cdot THR_j), & \text{if } |cD_j| > THR_j \\ 0, & \text{otherwise} \end{cases}, \quad (18)$$

where $\beta \in \mathbb{R}^+$ and $\beta > 1$. In our study, we used 15 from the suggestion of Su and Zhao work (2005).

11) Custom function (CUT): Idea of this function is similar to that of NNG function, in the sense that CUT and NNG are continuous and can adapt to the signal characteristics. Denote $0 < \gamma < THR_j$ and $0 < a < 1$. In our studies, we used the same threshold as in Yoon and Vaidyanathan (2004) work with $a = 1$ and $\gamma = THR_j/2$. The equation can be expressed as

$$cD_j = \begin{cases} cD_j + \text{sgn}(cD_j)(1 - \alpha)THR_j, & \text{if } |cD_j| \geq THR_j \\ 0, & \text{if } |cD_j| \leq \gamma, \\ \alpha \cdot THR_j \left(\frac{|cD_j| - \gamma}{THR_j - \gamma} \right)^2 \left\{ (\alpha - 3) \left(\frac{|cD_j| - \gamma}{THR_j - \gamma} \right) + 4 - \alpha \right\}, & \text{otherwise} \end{cases} \quad (19)$$

12) Firm function (FIM): It remedies the drawbacks of HAD and SOF functions. Gao and Bruce (1997) generalize a general FIM function using double threshold values. The THR_2 is defined by universal rule but THR_1 is scoped to range between 0 and THR_2 . According to the previous experiments, Gao and Bruce (1997) suggested that when THR_1 equals $2/3THR_2$, the denoised results would be better. FIM can be expressed as follows

$$cD_j = \begin{cases} 0, & \text{if } |cD_j| \leq THR_1 \\ \text{sgn}(cD_j) \left[\frac{THR_2 (|cD_j| - THR_1)}{(THR_2 - THR_1)} \right], & \text{if } THR_1 < |cD_j| < THR_2 \\ cD_j, & \text{if } |cD_j| > THR_2 \end{cases} \quad (20)$$

13) Modified firm function (MFM): It is a modified version of general FIM function. A higher order polynomial is used to replace the linear function in the interval $[THR_1, THR_2]$. This modification enables to get a differentiable thresholding function. The expression (Gao & Bruce, 1997) can be defined as

$$cD_j = \begin{cases} 0, & \text{if } |cD_j| \leq THR_1 \\ \text{sgn}(cD_j) (r_2 - r_1 |cD_j|) (|cD_j| - THR_1)^2, & \text{if } THR_1 < |cD_j| < THR_2 \\ cD_j, & \text{if } |cD_j| > THR_2 \end{cases} \quad (21)$$

$$\text{where } r_1 = \frac{(THR_1 + THR_2)}{(THR_2 - THR_1)^3} \text{ and } r_2 = \frac{2THR_2^2}{(THR_2 - THR_1)^3}.$$

14) Qian function (QIN): It is a compromise shrinkage between HAD and SOF by constant parameter Q . Where Q is 1, it is equivalent to SOF and it is equivalent to HAD, when Q is ∞ . QIN with $Q = 2$ is suggested from the experiments in (Qian, 2001). It is given by

$$cD_j = \begin{cases} cD_j \frac{\|cD_j\|^Q - THR^Q}{\|cD_j\|^Q}, & \text{if } |cD_j| > THR \\ 0, & \text{otherwise} \end{cases} \quad (22)$$

15) Yasser function (YAS): YAS shrinks the wavelet's detail coefficients which are lower than threshold value instead of set to be zero. Moreover, it has a constant parameter γ in

order to apply a nonlinear function to the threshold value. When γ is 3, the good results in speech signal are obtained (Ghanbari & Karami-Mollaei, 2006), which can be expressed as

$$cD_j = \begin{cases} cD_j, & \text{if } |cD_j| > THR \\ \text{sgn}(cD_j) \frac{|cD_j|^\gamma}{THR^{\gamma-1}}, & \text{otherwise} \end{cases} \quad (23)$$

5. Review of wavelet denoising in sEMG signal analysis

Selection of suitable wavelet denoising parameters is critical for the success of sEMG signal filtration in wavelet domain, because there is currently no known method to calculate the combination of the above wavelet denoising parameters that gives the best results. Therefore, many works have tried to find the optimal wavelet denoising parameters which lead to maximum filtration performance. All research studies about wavelet denoising parameters in analysis of the sEMG signals have been discussed in this section (Guo et al., 2004a, 2004b, 2005; Hussain et al., 2007, 2009; Jiang & Kuo, 2007; Khezri & Jahed, 2008; Li et al., 2010; Liu & Luo, 2008; Luo et al., 2007; Moshou et al., 2000; Ren et al., 2006; Yang & Luo, 2004; Zhang & Luo, 2006; Zhang et al., 2010) as summarized in Table 3.

In details, the sEMG signal analysis based on WT has been firstly proposed in 2000 by Moshou et al. (2000). Wavelet-based denoising is used to separate coordinated muscle activity of the shoulder of a driver related to certain movements that appear during driving a car. The denoised signals show clearly the real muscle activity bursts that mean the small activity peaks covered by the screen of noises are now observable. In Moshou et al. (2000) work, the simplest thresholding function, HAD, is used with a decomposition using db5 at 5 decomposition levels. Afterwards, Guo et al. (2004a, 2004b, 2005) compared four classical threshold selection rules: Universal, SURE, Hybrid and Minimax, and two classical thresholding functions: HAD and SOF, with real sEMG signal acquired from normal walking on the flat. They used the sym5 at 3 decomposition levels in their application. Evaluation criterion of both Moshou et al. (2000) and Guo et al. (2004a, 2004b, 2005) works is based on the observation of the sEMG waveforms between noisy sEMG signal and denoised sEMG signal. Jiang and Kuo (2007) compare the similar wavelet denoising parameters as Guo et al. (2004a, 2004b, 2005), but the acquired sEMG signals are changed from the normal walking activity to the mouse clicking activity; in addition, the simulated signals at 16-dB SNR have also been deployed. In Jiang and Kuo (2007) work a new evaluating function is proposed which is called signal-to-noise estimator (SNE). They prove that this evaluating function works well for the simulated signals but it does not work for the real sEMG signals. Subsequently, Jiang and Kuo concluded that the denoised sEMG signal is insensitive to the selection of wavelet denoising parameters. Furthermore, the db2 at 6 decomposition levels is used in their work due to the suggestion of previous study (Wellig & Moschytz, 1998). Zhang and Luo (2006) pay attention to apply wavelet denoising technique with control of the upper-limb prostheses. Some classical threshold selection rules and thresholding functions are employed (Liu & Luo, 2008; Luo et al., 2007; Yang & Luo, 2004). In addition, in one of their works, Zhang and Luo (2006) propose the new modified threshold selection rule and thresholding function. The sym8 at 4 decomposition levels is performed in denoising and extracting procedures. However, the results in Zhang, Luo and Liu works (Liu & Luo, 2008; Luo et al., 2007; Yang & Luo, 2004; Zhang & Luo, 2006) are also only observed from the

figures as same as employed in Moshou et al. (2000) and Guo et al. (2004a, 2004b, 2005) works.

Reference	Application	Wavelet denoising parameters				
		1	2	3	4	5
Moshou et al. (2000)	Identifying car driver fatigue and movement	db5	5	-	-	HAD, SOF
Guo et al. (2004a, 2004b, 2005)	Lower limb prosthesis control	sym5	3	Universal, SURE, Hybrid, Minimax	-	HAD, SOF
Jiang & Kuo (2007)	MUAP detection	db2	6	Universal, SURE, Hybrid, Minimax	-	HAD, SOF
Zhang & Luo (2006)	Upper limb prosthesis control	sym8	4	LVMU	-	HAD, SOF, WAV
Yang & Luo (2004)	Upper limb prosthesis control	sym8	4	Hybrid	-	SOF
Khezri & Jahed (2008)	Upper limb prosthesis control	Daubechies Symlets Coiflet Biorthogonal	6	Hybrid Bayes Shrink	-	SOF
Hussain et al. (2007)	Detecting muscle fatigue	db2, db6, db8, dmey	4	-	-	HAD
Hussain et al. (2009)	Determining muscle contraction (walking speed)	db2, db4, db5, db6, db8, sym4, sym5, dmey	4	Universal	-	HAD
Li et al. (2010)	Upper limb prosthesis control	-	4	-	-	SOF
Zhang et al. (2010)	-	sym2	5	Minimax	-	SOF

Table 3. Applications of wavelet denoising algorithms with the sEMG signal. Note that wavelet denoising parameters: (1) the type of wavelet basis function, (2) the decomposition level, (3) threshold selection rule (4) threshold rescaling method, and (5) thresholding function.

Later, Khezri and Jahed (2008) proposed a usefulness of classical threshold selection rule, called Hybrid, to estimate the denoised upper-limb sEMG signals. It improved the accuracy of the sEMG classification compared with the one without denoising pre-processing stage and Bayes Shrink threshold selection rule. Following that, in one of our works (Phinyomark et al., 2009f), we compared Hybrid with three other classical threshold selection rules. The results showed that Universal yields better denoising performance than the others including Hybrid. Moreover, Hussain et al. (2007, 2009) suggested that pre-processing stage using the

Universal threshold selection rule and HAD thresholding function was able to improve the classification of the lower- and upper- limb activities, respectively. All of these introduced literatures work well for the surface EMG signal. On the other hand, for the intramuscular EMG signal, Ren et al. (2006) developed a technique for extracting and classifying motor unit action potentials (MUAPs) for needle EMG signal decomposition. In that technique, noise reduction based on threshold estimation calculated in the WT was proposed. The needle EMG signal is decomposed by the WT at ninth level with the db5. HAD thresholding is implemented with the semi-automatic threshold estimator, which is defined as $THR = \sigma \cdot \lambda$ where λ is set to be between 8 and 15 by the user in accordance with the SNR and σ is the noise energy estimated from the minimum value of the second moment feature in time domain. However, this threshold estimator is not suitable for surface EMG signal because in the MUAP detection, useful MUAP components have most of their energy in low-frequency components. Therefore, threshold obtained by this estimator has a large value (most high frequency components could be set to zeros). On the contrary, some high frequency components are still important for surface EMG signal, thus proposed technique in Ren et al. work (2006) is not included in our study. However, even though the results from most of previous works are not presented using the quantitative results, the improving ability in those applications based on wavelet denoising algorithm has been definitely established (Hussain et al., 2009; Khezri & Jahed, 2008; Ren et al., 2006; Zhang et al., 2010). In order to more clearly understand the effectiveness of wavelet denoising algorithm over conventional filters, discussion and illustration have been presented in review of Zhang et al. (2010).

6. Experimental results with real sEMG signals

The sEMG data that are used to demonstrate and evaluate the wavelet denoising parameters in our study were recorded from two forearm muscles and six upper-limb movements. Two forearm muscles are flexor carpi radialis muscle and extensor carpi radialis longus muscle and six upper-limb movements are hand open, hand close, wrist extension, wrist flexion, pronation, and supination. The sEMG signals were recorded by two pairs of surface electrodes (3M red dot 25 mm. foam solid gel). Each electrode was separated from the other by 20 mm. A band-pass filter of 10-450 Hz bandwidth and an amplifier with 60 dB gain were used. Sampling rate was set at 1000 samples per second using a 16 bit A/D converter board (IN BNC-2110, National Instruments Corporation). The sample size of each EMG data is 256 ms for the real-time constraint that the response time should be less than 300 ms (Englehart et al., 2001).

To evaluate the ability of wavelet denoising algorithm, two criteria are usually used based on: (1) the difference between signal values implied by a wavelet denoising method and the original signal values; and (2) the difference between classification accuracy obtained from the denoised signal and classification accuracy obtained from the raw signal (Phinyomark et al., 2010b). However, most studies have focused to evaluate the quality of wavelet denoising method based on the first criterion. In this chapter, we have evaluated the ability of wavelet denoising methods with only the first criterion; however, the relationship between the first criterion and the second criterion has been discussed.

The first criterion is error measure. One of the most popular methods is mean square error (MSE) that is also employed in our study. However, there are a lot of error measures; for instances, mean absolute error (MAE), mean absolute percentage error (MAPE), mean error (ME), mean percentage error (MPE), root mean square error (RMSE), percentage root-mean-

square difference (PRD), signal-to-noise ratio output (SNR_{out}), and improved signal-to-noise ratio (ISNR). Due to the similarity of these measured indices, normally only one of these indices is selected to use in evaluating study. Definition of the MSE can be expressed as

$$MSE = \frac{\sum_{i=1}^N (f_i - fe_i)^2}{N}, \quad (24)$$

where f_i represents the estimated sEMG signal from the original signal and fe_i is estimated sEMG signal from the noisy signal. The performance of wavelet denoising method is better when these indices including MSE are smaller. It means that useful information in the sEMG signal is remained and undesirable parts of the sEMG signal are removed. To guarantee the best wavelet denoising method achieved and optimized for estimating of useful sEMG signals, more than one times of additional noises should be done and in each time the level of noises should be varied from low noise level to high noise level; for example, 20-0 dB SNRs. The effect of different noise levels could be observed through this procedure. Example of the original sEMG signal and the sEMG signal with the WGN at 5 dB SNR are shown in Fig. 3. The SNR can be calculated by

$$SNR = 10 \log \frac{P_{clean}}{P_{noise}}, \quad (25)$$

where P_{clean} is power of the original sEMG signal and P_{noise} is power of the WGN.

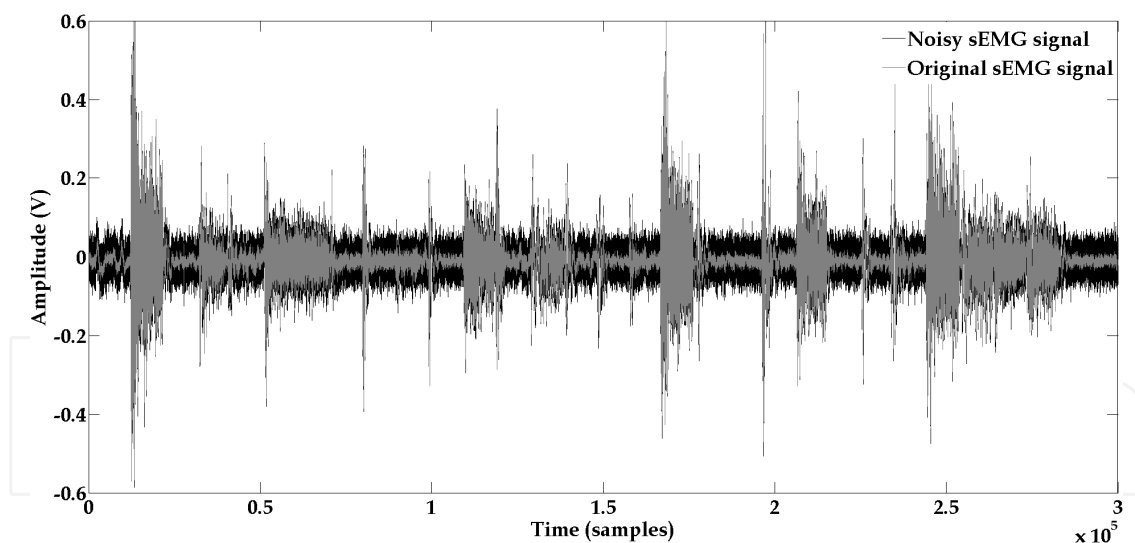

Fig. 3. Original sEMG signal (gray line) and noisy sEMG signal at 5 dB SNR (black line) with random and repeatable six upper-limb movements.

6.1 Wavelet basis functions

Firstly, the selection of an optimal wavelet function was done. The MSE calculated from 53 wavelet functions (in Table 1) were employed. The results are respectively shown in Fig. 4(a) and Fig. 4(b) at two levels of noises, low and high noise levels. The figure is plotted in log-lin type of a semi-log graph, defined by a logarithmic scale on the y axis, and a linear scale on the x axis. From the figure, the results of wavelet functions in high and low levels of

noises have the similar trend. As SNR increases, the MSE of each wavelet function also increases. The smallest MSE is db1, bior1.1 and rbio1.1. Their MSEs are 0.00407, 0.01242, 0.04090, 0.12739 and 0.41242 at SNR value of 20, 15, 10, 5 and 0 dB, respectively. It produces the best denoising wavelets. The db2, db7, sym2, bior5.5 and rbio2.2 provide marginally better performance than the rest candidates. Furthermore, the various orders of Daubechies (db1-db10), Symlets (sym2-sym8), BiorSplines (bior1.1-bior1.5, bior4.4, bior5.5, and bior6.8), Coiflet (coif1-coif2), and ReverseBior (rbio1.1-rbio3.9, rbio6.8) can be used to reduce noises. The most terrible wavelet function is bior3.1. Its MSE is as much as seven of the minimum MSE. The third order of decomposition of BiorSplines (Bior3.3, bior3.5, bior3.7, and bior3.9) and Discrete Meyer (dmey) are worse performance. Its MSE is as much as two of the minimum MSE. Moreover, in high noise, the second order of decomposition of BiorSplines (bior2.2-bior2.8) and the fifth order of decomposition of ReverseBior (rbio5.5) are not good. Therefore, these functions are not recommended to use for denoising sEMG signal.

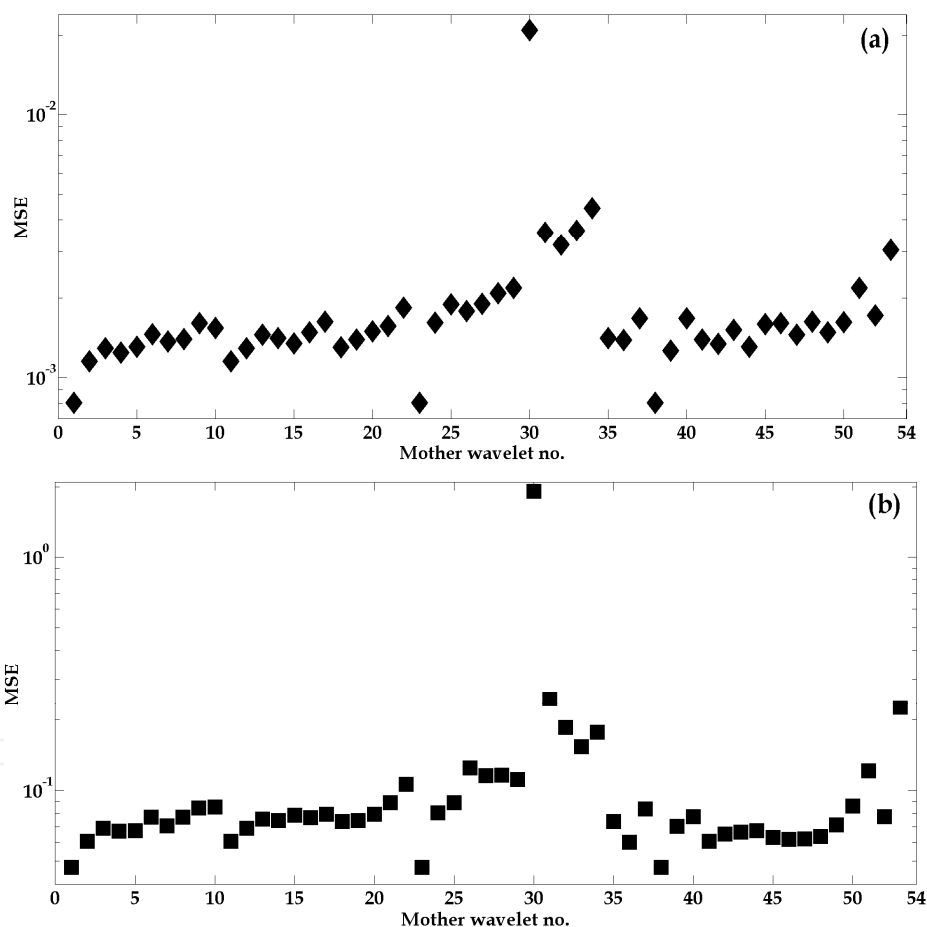

Fig. 4. MSE calculated from all wavelet functions (mother wavelet no. refer to the wavelets in Table I, i.e. #1-Daubechies order 1, #2-Daubechies order 2, ..., #11-Symlets order 2, ..., #18-Coiflet order 1, ..., #53-Discrete Meyer) (a) at 20 dB SNR (b) at 0 dB SNR. Note that decomposition level is 4, threshold selection rule is Universal, threshold rescaling method is GL for N parameter and LD for σ parameter, and thresholding function is SOF.

If we consider only optimal wavelets for denoising, we can conclude that db1, bior1.1 and rbio1.1 are the best ones. However, the ability of these functions in classification viewpoint is poor. Hence, for real-world application, these wavelet functions are not recommended.

The db2, db7, sym2, bior5.5 and rbio2.2 are prospective to have good performance in both denoising and classification performance. At this point we recommend wavelet functions in this group to be used in future works. Note that we are not reported the classification results in this work because the suitable wavelet functions depend on the classifier types (such as neural network, fuzzy logic, neuro-fuzzy classifier, probabilistic classifier, etc.). One of the useful results in classification viewpoint is presented in Englehart (1998) work. In Englehart study, wavelet coefficients are extracted from upper-limb sEMG signals and are subjected to dimensionality reduction method. As a result, classification errors are reported. Within the Daubechies, Coiflet and Symlet families, the best performance is db18, coif4 and sym8, respectively. Interesting trend is the improvement of classification performance that it tends to increase with the order of wavelet function. Hence, if balance between class separability and robustness is considered, the db7, sym5 and coif4 are some compromise wavelets.

6.2 Decomposition levels

Secondly, the selection of an optimal decomposition level was done. Fig. 5(a) and Fig. 5(b) present the effects of decomposition levels for five wavelet functions. When decomposition levels are more than seven, the MSE rapidly increases. Therefore, in Fig. 5(a) and Fig. 5(b), only first eight levels are shown. We found that the third and the fourth levels are better than other levels for low level of noises (20-10 dB SNRs). On the other hand, the fourth and the fifth levels are better than the others for high level of noises (10-0 dB SNRs). The effect of wavelet function with an optimal wavelet function is a little bit. The decomposition level 4 is suggested to be used as a compromise level between high and low level of noises.

6.3 Threshold selection rules

Thirdly, the selection of an optimal threshold selection rule was done. For the classical threshold selection rules, Universal rule is better than other classical methods as can be observed in Fig. 6. Hence, modified versions of Universal threshold selection rule are proposed and also evaluated. The MSE of LSMU rule is the lowest, followed closely by LVNU, SMU and Universal rules. GSMU rule have slightly larger error, and LMU and SLMU rules have a large error. However, in classification viewpoint, GSMU rule is the best threshold selection rule (Phinyomark et al., 2009f).

6.4 Threshold rescaling methods

Fourthly, the selection of an optimal threshold rescaling method was done. From our previous study (Phinyomark et al., 2009f), the optimal rescaling method is dependent on type of threshold selection rules. However, the general trend can be observed. For the threshold rescaling of N parameter, the GL is better than the LD. For the threshold rescaling of σ parameter, the suitable rescaling method is dependent on the level of noises. At very high noise, the LD is better than the FL. On the other hand, at medium to low noise, the FL is better than the LD.

6.5 Thresholding functions

Fifthly, the selection of an optimal thresholding function was done. In Fig. 7, the MSEs of 15 thresholding functions and no denoising case with only WT are presented. At medium and high levels of noises, SNR is lower than 10 dB, all functions are better than WT except MFM. However, at low level of noises, 15 dB SNR, CUT, FIM and MFM are worse than WT. In addition, HAD, MHP, CUT and MFM are worse than WT at very low noise, 20 dB SNR.

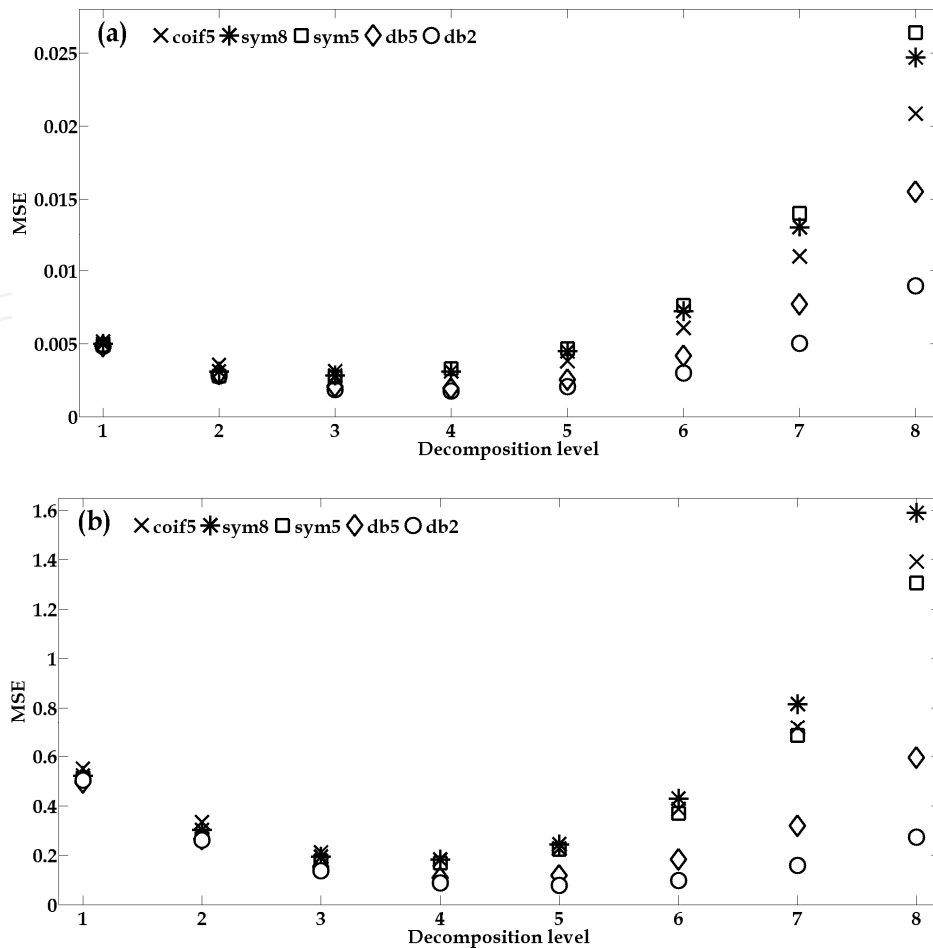

Fig. 5. MSE of five wavelet functions with eight decomposition levels (a) at 20 dB SNR (b) at 0 dB SNR. Note that threshold selection rule is Universal, threshold rescaling method is GL for N parameter and LD for σ parameter, and thresholding function is SOF.

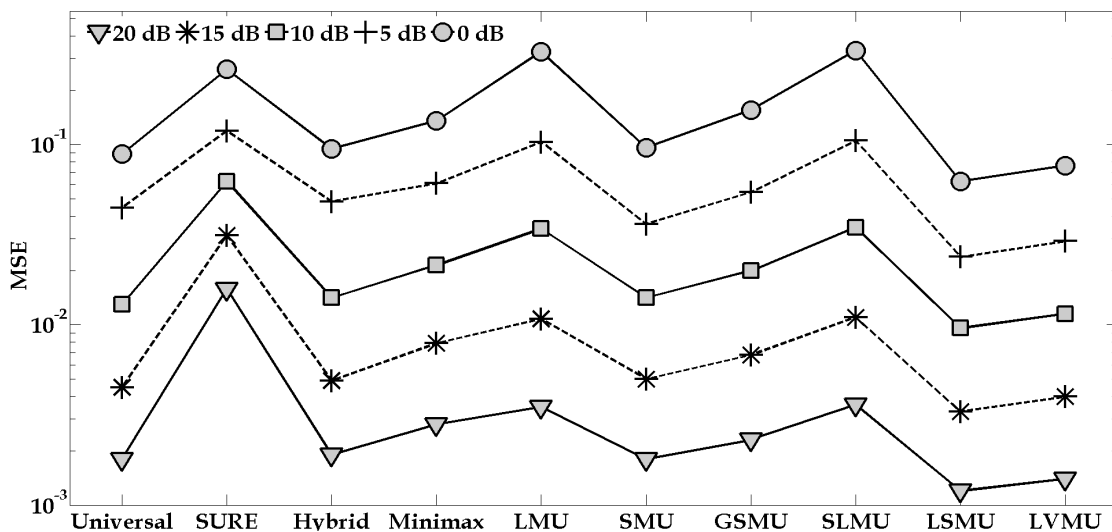

Fig. 6. MSE of four classical and six modified threshold selection rules at 20-0 dB SNR. Note that wavelet function is db2, decomposition level is 4, threshold rescaling method is GL for N parameter and LD for σ parameter, and thresholding function is SOF.

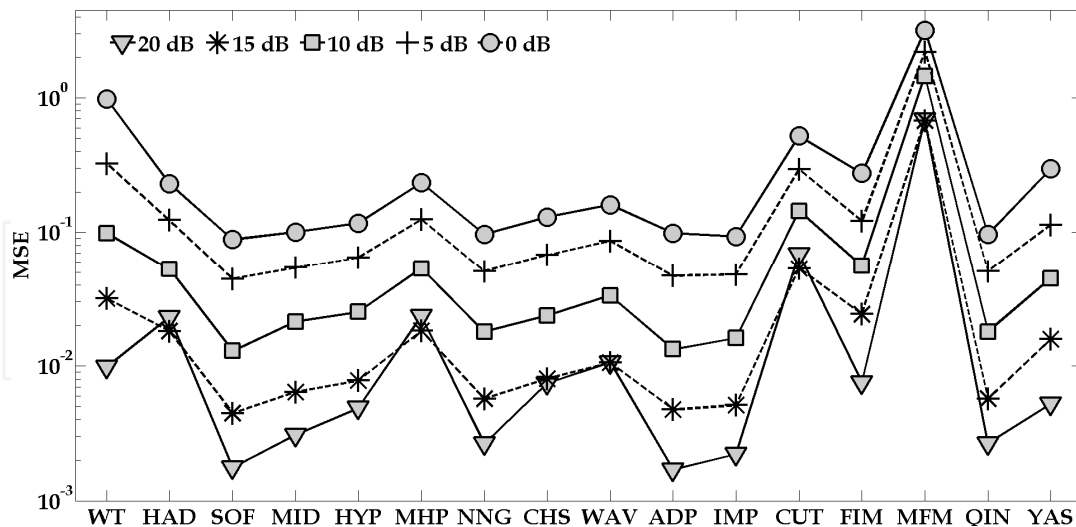

Fig. 7. MSE of WT and fifteen modified universal thresholding rules at 20-0 dB SNR. Note that wavelet function is db2, decomposition level is 4, threshold selection rule is Universal, and threshold rescaling method is GL for N parameter and LD for σ parameter.

As SNR increases, the MSE of each function as well increases. From the experimental results, the MSE of ADP is lowest, followed closely by SOF and IMP. It means that ADP is the best thresholding function in denoising viewpoint. MSE of WT is seven times the MSE of ADP at low noise and is three times the MSE of ADP at high noise. Moreover, in classification viewpoint, ADP is also the best thresholding function (Phinyomark et al., 2010b); whereas, the classification performance of SOF is not good.

7. Conclusion and future trends

Noises contaminated in the sEMG signals are an unavoidable problem during recording data; whereas noises are a main problem in analysis of the sEMG signal both in clinical and engineering applications. Random noises that have their frequency components fall in the energy band of the sEMG signal are the major problem. Conventional filters do not effectively remove random noises but wavelet denoising algorithm is not problematical in this way. Hence, numerous wavelet denoising methods have been proposed during the last decade. Suggestion of five wavelet denoising parameters in a compromise between two viewpoints, denoising and classification, is presented in the following:

- wavelet function: db2, db7, sym2, sym5, coif 4, bior5.5 and rbio2.2;
- decomposition level: 4;
- threshold selection rule: GSMU;
- threshold rescaling methods: LD for N parameter and FL or LD for σ parameter; and
- thresholding function: ADP.

Recommendation above can be useful to apply for many sEMG applications. However, for analysis of intramuscular EMG signal, re-evaluation of wavelet denoising parameters should be done because the purpose in interpretation is different (Ren et al., 2006). However, the pre-processing stage based on wavelet denoising algorithm is recommended to be implemented in analysis of sEMG signal, especially in multifunction myoelectric control system.

8. Acknowledgment

This work was supported in part by the Thailand Research Fund (TRF) through the Royal Golden Jubilee Ph.D. Program (Grant No. PHD/0110/2550), and in part by NECTEC-PSU Center of Excellence for Rehabilitation Engineering, Faculty of Engineering, Prince of Songkla University through Contact No. EMG540014S.

9. References

- Andrade, A. O.; Nasuto, S.; Kyberd, P.; Sweeney-Reed, C. M. & Van Kanijn, F. R. (2006). EMG Signal Filtering based on Empirical Mode Decomposition. *Biomedical Signal Processing and Control*, Vol.1, No.1, (January 2006), pp. 44-55, ISSN 1746-8094
- Baratta, R. V.; Solomonow, M.; Zhou, B. H. & Zhu, M. (1998). Methods to Reduce the Variability of EMG Power Spectrum Estimates. *Journal of Electromyography and Kinesiology*, Vol.8, No.5, (1991), pp. 279-285, ISSN 1050-6411
- Boostani, R. & Moradi, M. H. (2003). Evaluation of the Forearm EMG Signal Features for the Control of a Prosthetic Hand. *Physiological Measurement*. Vol.24, No.2, (February 1980), pp. 309-319, ISSN 0967-3334
- Clancy, E. A.; Morin, E. L. & Merletti, R. (2002). Sampling, Noise-reduction and Amplitude Estimation Issues in Surface Electromyography. *Journal of Electromyography and Kinesiology*, Vol.12, No.1, (1991), pp. 1-16, ISSN 1050-6411
- De Luca, C. J. (2002). Surface Electromyography: Detection and Recording, In: *DelSys Incorporated*, 10.05.2011, Available from http://www.delsys.com/Attachments_pdf/WP_SEMGintro.pdf
- De Luca, C. J.; Gilmore, L. D.; Kuznetsov, M. & Roy, S. H. (2010). Filtering the Surface EMG Signal: Movement Artifact and Baseline Noise Contamination. *Journal of Biomechanics*, Vol.43, No.8, (January 1968), pp. 1573-1579, ISSN 0021-9290
- Donoho, D. L. (1992). Wavelet Analysis and WVD: A Ten Minute Tour, In: *Progress in Wavelet Analysis and Applications*, Meyer, Y. & Roques, S., pp. 109-128, Frontières Ed.
- Donoho, D. L. (1995). De-noising by Soft-thresholding. *IEEE Transactions on Information Theory*, Vol.41, No.3, (1955), pp. 613-627, ISSN 0018-9448
- Donoho, D. L. & Johnstone, I. M. (1994). Ideal Spatial Adaptation by Wavelet Shrinkage. *Biometrika*, Vol.81, No.3, (October 1901), pp. 425-455, ISSN 0006-3444
- Donoho, D. L. & Johnstone, I. M. (1995). Adapting to Unknown Smoothness via Wavelet Shrinkage. *Journal of the American Statistical Association*, Vol.90, No.432, (March 1888), pp. 1200-1224, ISSN 0162-1459
- Elena, M. M.; Quero, J. M. & Borrego, I. (2006). An Optimal Technique for ECG Noise Reduction in Real Time Applications. *Proceedings of CinC 2006 Computers in Cardiology*, pp. 225-228, ISBN 978-1-4244-2532-7, Valencia, Spain, September 17-20, 2006
- Englehart, K. (1998). *Representation and Classification of the Transient Myoelectric Signal*. Ph.D. Thesis, University of New Brunswick, Fredericton, N.B., Canada.
- Englehart, K.; Hudgins, B. & Parker, P. A. (2001). A Wavelet-Based Continuous Classification Scheme for Multifunction Myoelectric Control. *IEEE Transactions on Biomedical Engineering*, Vol.48, No.3, (1953), pp. 302-311, ISSN 0018-9294

- Gao, H. Y. (1998). Wavelet Shrinkage Denoising Using the Non-negative Garrote. *Journal of Computational and Graphical Statistics*, Vol.7, No.4, (1992), pp. 469-488, ISSN 1061-8600
- Gao, H. Y. & Bruce, A. G. (1997). WaveShrink with Firm Shrinkage. *Statistica Sinica*, Vol.7, No.4, (January 1991), pp. 855-874, ISSN 1017-0405
- Ghanbari, Y. & Karami-Mollaei, M. R. (2006). A New Approach for Speech Enhancement based on the Adaptive Thresholding of the Wavelet Packets. *Speech Communication*, Vol.48, No.8, (May 1982), pp. 927-940, ISSN 0167-6393
- Guo, X.; Yang, P.; Li, Y. & Yan, W. L. (2004a) The SEMG Analysis for the Lower Limb Prosthesis Using Wavelet Transform. *Proceedings of IEMBS 2004 26th Annual International Conference of the IEEE Engineering in Medicine and Biology Society*, pp. 341-344, ISBN 0-7803-8439-3, San Francisco, CA, USA, September 1-5, 2004
- Guo, X.; Yang, P.; Li, L. F. & Yan, W. L. (2004b) Study and Analysis of Surface EMG for the Lower Limb Prosthesis. *Proceedings of ICMLC 2004 3rd International Conference on Machine Learning and Cybernetics*, pp. 3736-3740, ISBN 0-7803-8403-2, Shanghai, China, August 26-29, 2004
- Guo, X.; Yang, P.; Liu, H. C. & Yan, W. L. (2005). Research and Analysis on the Effect of Joint Angle on EMG in Thigh Muscles. *Proceedings of CNIC 2005 1st International Conference on Neural Interface and Control Proceedings*, pp. 139-142, ISBN 0-7803-8902-6, Wuhan, China, May 26-28, 2005
- Huang, H.; Zhang, F.; Sun, Y. L. & He, H. (2010). Design of a Robust EMG Sensing Interface for Pattern Classification. *Journal of Neural Engineering*, Vol.7, No.5, (March 2004), pp. 056005-1-056005-10, ISSN 1741-2560
- Huigen, E.; Peper, A. & Grimbergen, C. A. (2002). Investigation into the Origin of the Noise of Surface Electrodes. *Medical and Biological Engineering and Computing*, Vol.40, No.3, (January 1963), pp. 332-338, ISSN 0140-0118
- Hussain, M.S.; Reaz, M. B. I.; Ibrahimy, M. I.; Ismail, A. F. & Yasin, F. M. (2007). Wavelet based Noise Removal from EMG Signals. *Informacije MIDEM*, Vol.37, No.2, (1971), pp. 94-97, ISSN 0352-9045
- Hussain, M. S.; Reaz, M. B. I.; Yasin, F. M. & Ibrahimy, M. I. (2009). Electromyography Signal Analysis Using Wavelet Transform and Higher Order Statistics to Determine Muscle Contraction. *Expert Systems*, Vol.26, No.1, (July 1984), pp. 35-48, ISSN 0266-4720
- Jiang, C. F. & Kuo, S. L. (2007). A Comparative Study of Wavelet Denoising of Surface Electromyographic Signals. *Proceedings of EMBS 2007 29th Annual International Conference of the IEEE Engineering in Medicine and Biology Society*, pp. 1868-1871, ISBN 978-1-4244-0787-3, Cite Internationale, Lyon, France, August 22-26, 2007
- Johnstone, I. M. & Silverman, B. W. (1997). Wavelet Threshold Estimators for Data with Correlated Noise. *Journal of the Royal Statistical Society: Series B (Statistical Methodology)*, Vol.59, No.2, (1934), pp. 319-351, ISSN 1369-7412
- Kale, S. N. & Dudul, S. V. (2009). Intelligent Noise Removal from EMG Signal Using Focused Time-Lagged Recurrent Neural Network. *Applied Computational Intelligence and Soft Computing*, Vol.2009, Article ID 129761, (2008), 12 pages, ISSN 1687-9724

- Kania, M.; Fereniec, M. & Maniewski, R. (2007). Wavelet Denoising for Multi-lead High Resolution ECG Signals. *Measurement Science Review*, Vol.7, No.4, (2001), pp. 30-33, ISSN 1335-8871
- Khezri, M. & Jahed, M. (2008). Surface Electromyogram Signal Estimation based on Wavelet Thresholding Technique. *Proceedings of EMBS 2008 30th Annual International Conference of the IEEE Engineering in Medicine and Biology Society*, pp. 4752-4755, ISBN 978-1-4244-1814-5, Vancouver, British Columbia, Canada, August 20-25, 2008
- Laterza, F. & Olmo G. (1997). Analysis of EMG Signals by Means of the Matched Wavelet Transform. *Electronics Letters*, Vol.33, No.5, (March 1995), pp. 357-359, ISSN 0013-5194
- Law, L. F.; Krishnan, C. & Avin, K. (2011). Modeling Nonlinear Errors in Surface Electromyography due to Baseline Noise: A New Methodology. *Journal of Biomechanics*, Vol.44, No.1, (January 1968), pp. 202-205, ISSN 0021-9290
- Li, Y. ; Tian, Y. & Chen, W. (2010). Multi-pattern Recognition of sEMG based on Improved BP Neural Network Algorithm. *Proceedings of CCC 2010 29th Chinese Control Conference*, pp. 2867-2872, ISBN 978-1-4244-6263-6, Beijing, China, July 29-31, 2010
- Liu, Z. & Luo, Z. (2008). EMG De-noising by Multi-scale Product Coefficient Hard Thresholding. *Journal of Huazhong University of Science and Technology (Natural Science Edition)*, Vol.36, No.1, (1972), pp. 134-136, ISSN 1671-4512
- Luo, Z. Z.; Zhang, Q. J. & Jiang, J. P. (2007). Improving Method for Surface Electromyography Denoising based on Wavelet Transform. *Journal of Zhejiang University (Engineering Science)*, Vol.41, No.2, (1956), pp. 213-216, ISSN 1008-973X
- Merletti, R. & Parker, P. (2004). *ELECTROMYOGRAPHY Physiology, Engineering, and Noninvasive Applications*, John Wiley & Sons, ISBN 0-471-67580-6, USA
- Mewett, D. T. ; Reynolds, K. J. & Nazeran, H. (2004). Reducing Power Line Interference in Digitised Electromyogram Recordings by Spectrum Interpolation. *Medical and Biological Engineering and Computing*, Vol.42, No.4, (January 1963), pp. 524-531, ISSN 0140-0118
- Moshou, D.; Hostens, I.; Papaioannou, G. & Ramon, H. (2000). Wavelets and Self-organising Maps in Electromyogram (EMG) Analysis. *Proceedings of ESIT 2000 European Symposium on Intelligent Techniques*, pp. 186-191, Aachen, Germany, September 14-15, 2000
- Percival, D. B. & Walden, A. T. (2000). *Wavelet Methods for Time Series Analysis*, Cambridge University Press, ISBN 0-521-64068-7, USA
- Phinyomark, A. ; Limsakul, C. & Phukpattaranont, P. (2008). EMG Feature Extraction for Tolerance of White Gaussian Noise. *Proceedings of I-SEEC 2008 International Workshop and Symposium Science Technology*, pp. 178-183, Nong Khai, Thailand, December 15-16, 2008
- Phinyomark, A. ; Limsakul, C. & Phukpattaranont, P. (2009a). EMG Feature Extraction for Tolerance of 50 Hz Interference. *Proceedings of ICET 2009 4th PSU-UNS International Conference on Engineering Technologies*, pp. 289-293, ISBN 978-86-7892-227-5, Novi Sad, Serbia, April 28-30, 2009
- Phinyomark, A. ; Limsakul, C. & Phukpattaranont, P. (2009b). A Novel EMG Feature Extraction for Tolerance of Interference. *Proceedings of ANSCSE 13 13th International*

- Annual Symposium on Computational Science and Engineering*, pp. 407-413, Bangkok, Thailand, March 25-27, 2009
- Phinyomark, A. ; Limsakul, C. & Phukpattaranont, P. (2009c). A Novel Feature Extraction for Robust EMG Pattern Recognition. *Journal of Computing*, Vol.1, No.1, (December 2009), pp. 71-80, ISSN 2151-9617
- Phinyomark, A. ; Limsakul, C. & Phukpattaranont, P. (2009d). Evaluation of Wavelet Function Based on Robust EMG Feature Extraction. *Proceedings of PEC 7 7th PSU-Engineering Conference*, pp. 277-281, Hat Yai, Thailand, May 21-22, 2009
- Phinyomark, A. ; Limsakul, C. & Phukpattaranont, P. (2009e). Evaluation of Mother Wavelet Based on Robust EMG Feature Extraction Using Wavelet Packet Transform. *Proceedings of ANSCSE 13 13th International Annual Symposium on Computational Science and Engineering*, pp. 333-339, Bangkok, Thailand, March 25-27, 2009
- Phinyomark, A. ; Limsakul, C. & Phukpattaranont, P. (2009f). A Comparative Study of Wavelet Denoising for Multifunction Myoelectric Control. *Proceedings of ICCAE 2009 International Conference on Computer and Automation Engineering*, pp. 21-25, ISBN 978-1-4244-3564-7, Bangkok, Thailand, March 8-10, 2009
- Phinyomark, A. ; Limsakul, C. & Phukpattaranont, P. (2009g). An Optimal Wavelet Function Based on Wavelet Denoising for Multifunction Myoelectric Control. *Proceedings of ECTI-CON 2009 6th International Conference on Electrical Engineering/Electronics, Computer, Telecommunications and Information Technology*, pp. 1098-1101, ISBN 978-1-4244-3388-9, Pattaya, Thailand, May 6-9, 2009
- Phinyomark, A. ; Limsakul, C. & Phukpattaranont, P. (2009h). EMG Denoising Estimation Based on Adaptive Wavelet Thresholding for Multifunction Myoelectric Control. *Proceedings of CITISIA 2009 3rd IEEE Conference on Innovative Technologies in Intelligent Systems and Industrial Applications*, pp. 171-176, ISBN 978-1-4244-2886-1, Monash University, Sunway Campus, Malaysia, July 25-26, 2009
- Phinyomark, A. ; Limsakul, C. & Phukpattaranont, P. (2010a). Optimal Wavelet Functions in Wavelet Denoising for Multifunction Myoelectric Control. *ECTI Transactions on Electrical Eng., Electronics, and Communications*, Vol. 8, No.1, (2003), pp. 43-52, ISSN 1685-9545
- Phinyomark, A. ; Limsakul, C. & Phukpattaranont, P. (2010b). EMG Signal Estimation Based on Adaptive Wavelet Shrinkage for Multifunction Myoelectric Control. *Proceedings of ECTI-CON 2010 7th International Conference on Electrical Engineering/Electronics, Computer, Telecommunications and Information Technology*, pp. 351-355, ISBN 978-1-4244-5607-9, Chiang Mai, Thailand, May 19-21, 2010
- Phinyomark, A. ; Phukpattaranont, P. & Limsakul, C. (2010c). EMG Signal Denoising via Adaptive Wavelet Shrinkage for Multifunction Upper-limb Prosthesis. *Proceedings of BMEiCON 2010 3rd Biomedical Engineering International Conference*, pp. 35-41, Kyoto, Japan, August 27-28, 2010
- Phinyomark, A. ; Phukpattaranont, P. & Limsakul, C. (2011). Wavelet-based Denoising Algorithm for Robust EMG Pattern Recognition. *Fluctuation and Noise Letters*, Vol.10, No.2, (March 2001), pp. 157-167, ISSN 0219-4775
- Poornachandra, S.; Kumaravel, N.; Saravanan, T. K. & Somaskandan, R. (2005). WaveShrink Using Modified Hyper-shrinkage Function. *Proceedings of IEEE-EMBS 2005 27th Annual International Conference of the Engineering in Medicine and Biology Society*, pp. 30-32, ISBN 0-7803-8741-4, Shanghai, China, January 17-18, 2006

- Qian, J. (2001). Denoising by Wavelet Transform, In: *Department of Electrical Engineering, Rice University*, 11.05.2011, Available from: <http://www.daimi.au.dk/~pnmn/spf02/CDROM/pr1/Litteratur/Denoising%20by%20wavelet%20transform.pdf>
- Reaz, M. B. I.; Hussain, M. S. & Mohd-Yasin, F. (2006). Techniques of EMG Signal Analysis: Detection, Processing, Classification and Applications. *Biological Procedures Online*, Vol.8, No.1, (May 1998), pp. 11-35, ISSN 1480-9222
- Ren, X.; Hu, X.; Wang, Z. & Yan, Z. (2006). MUAP Extraction and Classification based on Wavelet Transform and ICA for EMG Decomposition. *Medical and Biological Engineering and Computing*, Vol.44, No.5, (1963), pp. 371-382, ISSN 0140-0118
- Song, G. & Zhao, R. (2001). Three Novel Models of Threshold Estimator for Wavelet Coefficients. *Proceedings of WAA 2001 2nd International Conference on Wavelet Analysis and Its Applications*, pp. 145-150, ISBN 3-540-43034-2, Hong Kong, China, December 18-20, 2001
- Su, L. & Zhao, G. (2005). De-noising of ECG Signal Using Translation-invariant Wavelet Denoising Method with Improved Thresholding. *Proceedings of IEEE-EMBS 2005 27th Annual International Conference of the Engineering in Medicine and Biology Society*, pp. 5946-5949, ISBN 0-7803-8741-4, Shanghai, China, January 17-18, 2006
- Tan, H. G. R.; Tan, A. C.; Khong, P. Y. & Mok, V. H. (2007). Best Wavelet Function identification System for ECG Signal Denoise Applications. *Proceedings of ICIAS 2007 International Conference on Intelligent and Advanced Systems*, pp. 631-634, ISBN 978-1-4244-1355-3, Kuala Lumpur, Malaysia, November 25-28, 2007
- Tianshu, Q.; Shuxun, W.; Haihua, C. & Yisong, D. (2002). Adaptive Denoising based on Wavelet Thresholding Method. *Proceedings of ICOSP 2002 6th International Conference on Signal Processing*, pp. 120-123, ISBN 0-7803-7488-6, Beijing, China, August 26-30, 2002
- Vidakovic, B. (1999). *Statistical Modeling by Wavelets*, John Wiley & Sons, ISBN 978-0-471-29365-1, USA
- Wellig, P. & Moschytz, G. S. (1998). Analysis of Wavelet Features for Myoelectric Signal. *Proceedings of ICECS 1998 IEEE International Conference on Classification. Electronics, Circuits and Systems*, pp. 109-112, ISBN 0-7803-5008-1, Lisboa, Portugal, September 7-10, 1998
- Yang, Q. Y. & Luo, Z. Z. (2004). Surface Electromyography Disposal based on the Method of Wavelet De-noising and Power Spectrum. *Proceedings of ICIMA 2004 IEEE International Conference on Intelligent Mechatronics and Automation*, pp. 896-900, ISBN 0-7803-8748-1, Chengdu, China, August 26-31, 2004
- Yoon, B. J. & Vaidyanathan, P. P. (2004). Wavelet-based Denoising by Customized Thresholding. *Proceedings of ICASSP 2004 IEEE International Conference on Acoustics, Speech, and Signal Processing*, pp. ii-925-ii-928, ISBN 0-7803-8484-9, Montreal, Canada, May 17-21, 2004
- Zardoshti-Kermani, M.; Wheeler, B. C.; Badie, K. & Hashemi, R. M. (1995). EMG Feature Evaluation for Movement Control of Upper Extremity Prostheses. *IEEE Transactions on Rehabilitation Engineering*, Vol.3, No.4, (March 1993), pp. 324-333, ISSN 1063-6528
- Zhang, Q. J. & Luo, Z. Z. (2006). Wavelet De-noising of Electromyography. *Proceedings of ICMA 2006 IEEE International Conference on Mechatronics and Automation*, pp. 1553-1558, ISBN 1-4244-0465-7, Luoyang, China, June 25-28, 2006

- Zhang, X.; Wang, Y. & Han, R. P. S. (2010). Wavelet Transform Theory and its Application in EMG Signal Processing. *Proceedings of FSKD 2010 7th International Conference on Fuzzy Systems and Knowledge Discovery*, pp. 2234-2238, ISBN 978-1-4244-5931-5, Qingdao, China, August 10-12, 2010
- Zhong, S. & Cherkassky, V. (2000). Image Denoising Using Wavelet Thresholding and Model Selection. *Proceedings of ICIP 2000 International Conference on Image Processing*, pp. 262-265, ISBN 0-7803-6297-7, Vancouver, BC, Canada, September 10-13, 2000

IntechOpen

IntechOpen

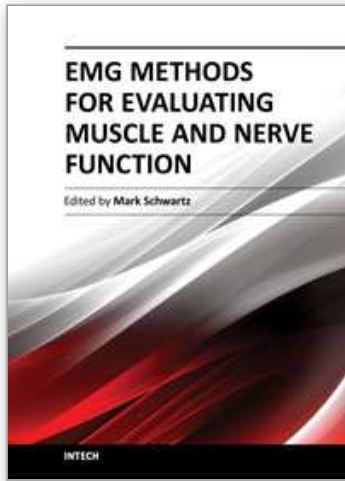

EMG Methods for Evaluating Muscle and Nerve Function

Edited by Mr. Mark Schwartz

ISBN 978-953-307-793-2

Hard cover, 532 pages

Publisher InTech

Published online 11, January, 2012

Published in print edition January, 2012

This first of two volumes on EMG (Electromyography) covers a wide range of subjects, from Principles and Methods, Signal Processing, Diagnostics, Evoked Potentials, to EMG in combination with other technologies and New Frontiers in Research and Technology. The authors vary in their approach to their subjects, from reviews of the field, to experimental studies with exciting new findings. The authors review the literature related to the use of surface electromyography (SEMG) parameters for measuring muscle function and fatigue to the limitations of different analysis and processing techniques. The final section on new frontiers in research and technology describes new applications where electromyography is employed as a means for humans to control electromechanical systems, water surface electromyography, scanning electromyography, EMG measures in orthodontic appliances, and in the ophthalmological field. These original approaches to the use of EMG measurement provide a bridge to the second volume on clinical applications of EMG.

How to reference

In order to correctly reference this scholarly work, feel free to copy and paste the following:

Angkoon Phinyomark, Pornchai Phukpattaranont and Chusak Limsakul (2012). The Usefulness of Wavelet Transform to Reduce Noise in the SEMG Signal, EMG Methods for Evaluating Muscle and Nerve Function, Mr. Mark Schwartz (Ed.), ISBN: 978-953-307-793-2, InTech, Available from:
<http://www.intechopen.com/books/emg-methods-for-evaluating-muscle-and-nerve-function/the-usefulness-of-wavelet-transform-to-reduce-noise-in-the-semg-signal>

INTECH
open science | open minds

InTech Europe

University Campus STeP Ri
Slavka Krautzeka 83/A
51000 Rijeka, Croatia
Phone: +385 (51) 770 447
Fax: +385 (51) 686 166
www.intechopen.com

InTech China

Unit 405, Office Block, Hotel Equatorial Shanghai
No.65, Yan An Road (West), Shanghai, 200040, China
中国上海市延安西路65号上海国际贵都大饭店办公楼405单元
Phone: +86-21-62489820
Fax: +86-21-62489821

© 2012 The Author(s). Licensee IntechOpen. This is an open access article distributed under the terms of the [Creative Commons Attribution 3.0 License](#), which permits unrestricted use, distribution, and reproduction in any medium, provided the original work is properly cited.

IntechOpen

IntechOpen