

We are IntechOpen, the world's leading publisher of Open Access books Built by scientists, for scientists

5,500

Open access books available

134,000

International authors and editors

165M

Downloads

Our authors are among the

154

Countries delivered to

TOP 1%

most cited scientists

12.2%

Contributors from top 500 universities



WEB OF SCIENCE™

Selection of our books indexed in the Book Citation Index
in Web of Science™ Core Collection (BKCI)

Interested in publishing with us?
Contact book.department@intechopen.com

Numbers displayed above are based on latest data collected.
For more information visit www.intechopen.com



Photon Total Body Irradiation for Leukemia Transplantation Therapy: Rationale and Technique Options

Brent Herron, Alex Herron, Kathryn Howell,
Daniel Chin and Luann Roads
*PSL Medical Center, Denver
USA*

1. Introduction

Leukemia is a classification of disease in which the two major defects are unregulated proliferation and incomplete maturation of the hemopoietic progenitors (Scheinberg, Maslak, & Weiss, 2001). Leukemia originates in the marrow, although leukemia cells may infiltrate lymph nodes, liver, spleen, and other tissues. Scheinberg et al. (2001) describe the principal clinical manifestation is the decrease of red cells and platelets as a result of the suppression of normal hemopoiesis or turnover and repopulation of blood components. In the chronic leukemias, unregulated proliferation of leukemia cells and elevated white cell count dominate. Differentiation and maturation of the leukemia cells may be largely preserved. Scheinberg further characterizes acute leukemias with unregulated proliferation also, but the maturation of the leukemia progenitors is profoundly impaired.

Transplantation of blood products, in particular stem cells, has become a common treatment procedure for various types of leukemias since the early 1990's (Scheinberg, Maslak, & Weiss, 2001). Cells void of leukemia are transplanted into the leukemia patient. The purpose of the transplant is the repopulation of the non-cancerous cells. Urbano-Ispizua et al. (2002) describes the current practice of stem cell transplantation for hematological diseases, solid tumors and immune disorders. Definitions, abbreviations and classifications described in this review are summarized here.

Hemopoietic stem cell transplantation (HSCT) refers to any procedure where hemopoietic cells of any donor type and any source are given to a recipient with the intention of repopulation/replacing the hemopoietic system of the recipient in total or in part (Urbano-Ispizua et al., 2002). Human Leukocyte Antigen (HLA) matching is a six point scoring system that identifies antigens and antibodies for both donor and recipient. Allogenic and autologous implants are also characterized by Urbano-Ispizua, et al (2002). Allogenic implants are procedures in which the recipient receives stem cells from a related or unrelated donor whose HLA score is identical (HLA score=6) or nearly identical (HLA score=5) to the recipient. Autologous implants refer to procedures in which the recipient receives stem cells from a collection performed while the patient is in remission or leukemia-free.

Bone marrow and cerebral spinal fluid peripheral cells are standard sources of hemopoietic stem cells (Urbano-Ispizua et al, 2002). For autologous HSCT, peripheral blood has become the preferred choice in view of its more rapid hemopoietic reconstitution. For allogenic HSCT, both sources are used. Both methods have their specific advantages and disadvantages. There are marked differences in toxicity concerning the donors. For recipients, the final issue concerning long-term outcome remains open. Peripheral blood is associated with more rapid engraftment or repopulation in the recipient. Urbano-Ispizua (2002) warns of a major concern with allogenic transplantation with peripheral blood is the high incidence of chronic graft-versus-host disease. That is, the recipient's immune system rejects the donor cells. In general, cord blood transplantation is recommended when patients require allogenic transplantation and do not have an HLA identical or a one-antigen mismatched donor.

Both allogenic and autologous implants are performed subsequent to subjecting the leukemia patient to intensity conditioning regimens (Shank, 1998). Despite the classification of the patient as in remission or disease-free, there is still significant opportunity that undetected leukemia cells are still present and will repopulate along with the transplanted stem cells. Shank describes the conditioning regimen's intent is to reduce the likelihood of the leukemia cell re-growth. Conditioning regimens include intense chemotherapy or radiation therapy or a combination of both. The intensity of these treatments is severe. Shank cautions of the fine balance between transplant-related mortality and the risk of relapse or repopulation of the leukemia cells.

The role of radiation therapy in the preparation of patients for bone marrow transplantation is the primary focus of this chapter. The primary utilization of radiation in oncology management is the use of small (less than 100 sq.cm) beams or fields directed at localized solid tumors (Bentel, 1992). Since leukemia cells are present throughout the body, large fields encompassing the entire body are necessary. This type of radiation treatment is referred to as Total Body Irradiation (TBI) or sometimes as Magna Field Irradiation (Shank, 1998). In her review article, Shank cites sole use TBI did not eradicate all leukemia cells. The addition of chemotherapy such as cyclophosphamide (CY) provides a reduced recurrence rate. Shank notes that although a large number of regimens now combine chemotherapeutic agents with and without TBI for marrow ablation, combined therapy of CY and TBI remains the standard for comparison.

Irradiation holds several advantages over chemotherapy as a systemic agent (Shank, 1998). These advantages include a lack of crossreactivity with other agents, dose homogeneity independent of blood supply, no requirements for detoxification and excretion, and the ability to tailor dose distribution within the body by shielding areas of greater sensitivity or boosting the radiation dose in areas that may contain additional disease. This discussion will focus primarily on the clinical aspects of TBI. Technical aspects of providing these large fields will also be addressed..

2. Total body irradiation: Criteria and nuances

Bentel (1992) describes standard methodology of radiation oncology treatments. Standard radiation therapy treatments are provided utilizing a linear accelerator with x-ray energies approximately 100 times greater than conventional machines used for chest or dental x-rays. The accelerator is capable of rotating 360 degrees about a patient with the center of rotation placed within the tumor volume. Typically, 2-6 fields or beams are directed at the tumor

volume from various angles. A criterion for field arrangement is accounting for dose uniformity within the tumor volume. That is, large variations in dose throughout the tumor are rarely acceptable. Bentel continues by specifying that additional beams will aid with dose uniformity. Beam angulation is determined by the desire to “spare” or reduce the radiation dose to non-malignant or non-cancerous tissue or organs. In most cases, the delivered radiation dose to the tumor is limited by normal tissue or organ tolerance in areas surrounding or close to the tumor volume (Bentel, 1997). Radiation doses are expressed in units of centigray (cGy) which is equivalent to the more common unit rad. Typical dose levels for standard non-TBI treatments are 4500-7000 cGy. Field dimensions are usually 100-200 sq.cm therefore; the fields are roughly 5 inches by 5 inches. Dose uniformity criteria is typically +/- 5%. The standard treatment distance from the housing of the accelerator is 100cm.

Van Dyk (2000) addresses the degree of accuracy required for total body irradiation treatments. As the specification of dose becomes less certain, disease control can be affected. In addition, undesirable radiation induced side effects can be pronounced. Van Dyk cites research that a 5% change in dose could result in a 20% change in the incidence of radiation pneumonitis. Under such circumstances, it is difficult to argue that +/- 5% accuracy is sufficient. Conversely, if the prescribed dose is well below the onset of radiation pneumonitis and if the dose is sufficient for adequate tumor control, then perhaps the guideline of +/- 5% accuracy can be relaxed and +/- 10% or even +/- 15% may be sufficiently accurate. The beam arrangement for total body irradiation is typically chosen with +/- 10% accuracy and uniformity criteria.

For large field radiotherapy, the delivery of a uniform dose of radiation over the entire target volume is not a trivial task. The irradiation method must be devised to produce radiation fields large enough to cover the entire body adequately. With this larger field size requirement, the patient is positioned further from the linear accelerator than the standard 100cm treatment distance. The increased distance takes advantage of the spread or divergence of the radiation field from the accelerator. The treatment distance can vary depending on the accelerator vault size, but is typically 350 to 500cm. The treatment distance for the TBI procedure represents a few additional problems (Lindsey & Deeg, 1998). These distances can be difficult to achieve in some linear accelerator vaults. Counter tops or other equipment will need to be removed. Since the patient will not be on the standard treatment couch at this extended distance, another adjustable patient support table must be acquired or fabricated.

Dose uniformity is a major concern for the TBI process and the technique option chosen (Bradley et al., 1998). Bentel (1992) describes the principle of radiation absorption. The absorption of radiation is exponentially proportional to the thickness of the different body sections of the patient. The variance between absorption and dose between thinner and thicker body sections is more pronounced as the x-ray energy is decreased. Therefore, higher x-ray energy aids the dose uniformity criteria. Fletcher describes a negative side to the use of higher x-ray energy. Unfortunately, higher x-ray energies provide decreased entrance dose with the first 2cm of the patient. That is, high energy x-rays will provide a more uniform dose in tissue only after the first 2cm. Therefore, the use of a x-ray energy greater than 4MV require the addition of an acrylic sheet placed in close proximity to the patient (Bradley et al., 1998). This acrylic sheet serves as a “beam spoiler” and produces scatter radiation that allows the entrance 2cm of tissue to receive a higher and more adequate dose.

Even with the use of high-energy x-rays and beam spoilers, the dose uniformity across the patient and from thicker to thinner body sections may not meet the $\pm 10\%$ criteria (Bredeson et al., 2002). Dose uniformity will improve if opposed beams are used. As shown and described in Figure 1, the beam can be directed from different sources (item d) or by changing the patient position from supine to prone. If a two-beam arrangement is utilized, half of the radiation dose is provided by one beam. The patient is rotated or the source of radiation is moved and the remaining dose is provided. Typically, two fields are adequate to provide acceptable dose homogeneity for TBI treatments (Bredeson et al., 2002).



Fig. 1. Front view of TBI table used for opposed lateral treatments with couch sections angled at 45° .

Large variations in patient thickness, e.g. head thickness compared to shoulder thickness, pose problems with dose uniformity that multiple fields cannot resolve (Bredeson et al., 2002). Galvin and D'Angio and Walsh (2000) and Lin and Chu (2001) have described methods for compensating for the lack of patient thickness in certain areas such as the head or feet. The addition of rice bags or water-filled bags serves as adequate substitutes in these areas of decreased thickness. Rice or water exhibits the same attenuation characteristics as human tissue. Therefore, packing the patient or filling voids with these materials presents the patient as a uniform thickness. Therefore absorption variations are minimized.

The parameters used to characterize the x-ray beam at the standard 100cm distance will not necessarily apply to the extended distance (Van Dyk, 2000). Beam profiles and output calibration of the linear accelerator at the treatment position will need to be measured.

Verification of the attenuation of the beam should be made with anthropomorphic or tissue equivalent phantoms. Scatter radiation from other components within the room, such as walls and equipment, will apply to this extended distance large field treatment and should be accounted.

One of the major complications of large field radiotherapy is radiation pneumonitis (Corns et al., 2000). For total lung radiation, this syndrome is lethal in 80% of the patients who develop it. Because of this effect, Corns et al. (2000) warns that it is imperative that the dose to the lung be precisely controlled to ensure the probability of its occurrence is minimal. Even in standard radiation treatments, a calculation of the lung dose requires density corrections to the standard attenuation data (Bentel, 1992). The lower density lungs will transmit more radiation than regular more dense tissue. Several methods have been developed to correct for the lower density lung tissue and provide an accurate accounting of dose in this region (Bentel, 1992). Unfortunately, these calculations vary in ease of use as well as in the resulting correction factor. Van Dyk (2000) has calculated the correction factor from four of the most popular methodologies and observed a +/-12% variation. Despite this variation in accounting accuracy, methods of lung dose reduction is often required (Van Dyk, 2000).

When a prescribed tumor dose is well above lung tolerance, the dose to lung will have to be reduced to minimize the probability of lung complication. Several methods can be used to reduce the dose. The techniques vary in complexity of design and application. All techniques incorporate one common concept: the use of an attenuator (Van Dyk, 2000). The attenuator absorbs radiation prior to delivering dose to the lungs. The decreased dose delivered to the lungs coupled with the increased transmission of dose within the lungs because of their lower density provides a dose comparable to rest of the body. Van Dyk describes several methods for the design of these attenuators. These methods vary from shielding the lungs with arm positioning to full or partial-transmission shielding blocks based on Computerized Tomography scans.

3. Representative Total Body Irradiation program

A representative TBI program is described here as an aid to the development of similar programs. Room modifications, technique selection, energy choice, and equipment necessary to achieve adequate dose uniformity in a comfortable setting are included in this discussion.

3.1 Accelerator room

TBI treatments should be performed with a high energy accelerator capable of providing photons of 15MV or greater. Lower x-ray energies can be utilized, but as the energy is decreased, dose homogeneity becomes more difficult to achieve with opposed fields. The distance to the closest wall with the gantry angled at 90 or 270 degrees will dictate the maximum field size to encompass the patient. Offset of the isocenter in the treatment vault design may allow for a greater treatment distance. Unfortunately, the desire to add TBI to the radiation therapy services may occur after a vault has been constructed. Most vaults are configured with a 20 foot width. Without an isocenter offset, this room width provides a source-wall distance of approximately 4m. Our institution's vault design provided a source-wall distance of slightly less than 4m. A 40x40 cm² field at 1m projects to 1.58m² without collimator rotation and 2.2m² with a 45° collimator rotation. Only a minor room

modification may be necessary to provide audio and visual communication with a patient positioned at this location.

3.2 Opposed lateral field TBI table

A portable surgical couch was obtained from a medical equipment reclamation firm. This modified couch is utilized for providing TBI treatments with opposed lateral fields. It is the technique of choice where treatment goals include dose uniformity without specific organ blocking. Figure 1 is a front view schematic of the couch arrangement. The effective length of the patient was reduced as sections of the couch are angled 45°. Four inch urethane foam cushions are used to separate the patient from any metal located on the couch. An additional egg crate cushion is provided for patient comfort. The couch height is adjusted vertically to coincide with the isocenter height of 1.3m.

After patient positioning, four beam spoiler plates constructed of 1/4" lexan polycarbonate are inserted into aluminum slots added to the couch. The width of the treatment table including the lexan polycarbonate plates is 52cm. Factoring in couch clearance to the wall, the source-tray distance for these lateral treatments is 374 cm. Our wall choice required a gantry angle selection of 270° (IEC). A collimator position of 20° and 340° is used for right lateral and left lateral fields, respectively.

Prior to treatment, a head and neck missing tissue compensator is positioned. An acrylic compensator is secured to a tray and supported with the accelerator hand support which is affixed to the accelerator couch rail (Fig. 2). The compensator angle position can be pivoted on the tray to match each patient. The compensator tray is rotated for the opposing lateral treatment and the couch longitudinal position is adjusted accordingly. The compensator bottom is curved to match the alignment between the patient neck and shoulders.

Tissue-equivalent rice bolus is used for additional missing tissue compensation for the body below the patient neck level. Figure 3 demonstrates the bolus placement. Since the patient's torso represents the widest section of the patient, bolus is typically only provided below the waist level between and around the legs and feet. The rice bag placement essentially makes the patient separation constant below the neck level and matching the maximum torso separation. Since the dose prescription point is typically at mid-depth at the umbilicus level. Tubes of rice and smaller individual plastic bags of rice with disposable outer covering are used for this aspect of patient preparation.

This treatment assumes that the treatment goal is to provide the same dose to the lungs as provided at the mid-umbilicus level. Prior to treatment, a lateral separation is determined at the nipple level. Previous chest x-ray review for over 50 patients revealed a relationship between this separation and the lateral width of the lungs. Of the lateral tissue separation, 77-83% of the tissue was comprised by the lower density lungs. Rather than measuring the lung width with a chest x-ray on each patient, we calculate the lung thickness as 80% of the full tissue thickness and assume a lung physical density of 0.35g/cm³. An effective thickness at this level is determined.

The arms are positioned at the patient's side thus adding higher density thickness to the chest area (Fig. 3.). The arm separation is determined and added to the effective thickness. This total is compared to umbilicus separation. If additional thickness is needed at the arm level to meet the thickness uniformity criterion of +/-1cm, additional "bolus with skin" (CIVCO, Orange City, IA) is added around the arm in 0.5cm increments until this criterion is met. A simple spreadsheet is used to perform these calculations as well as print setup instructions.



Fig. 2. Acrylic head and neck compensator mounted on post connected to accelerator couch rail arm support.

Monitor unit settings are calculated for the mid-depth at the umbilicus level. In-vivo entrance and exit dosimeters are placed at the head, neck, nipple, umbilicus, knee and ankle levels. After delivery of one half of the fractional dose, the patient remains positioned and the table is rotated 180°. The collimator is rotated to correspond to the new lateral orientation. The head and neck compensator is repositioned. The remainder of the treatment is provided. The dose rate from the accelerator is reduced between 100-200MU/min at isocenter. This machine dose rate reduction, the measured distance correction output factor, and attenuation will provide a dose delivery near 7cGy/minute. Dose rate has been determined to have a significant effect on lung toxicity. Most treatment protocols require dose delivery less than 10cGy/minute. Treatment times are approximately 15 minutes per field. This method of TBI delivery offers a uniform dose, easy and reproducible field arrangement, and a comfortable patient setup.

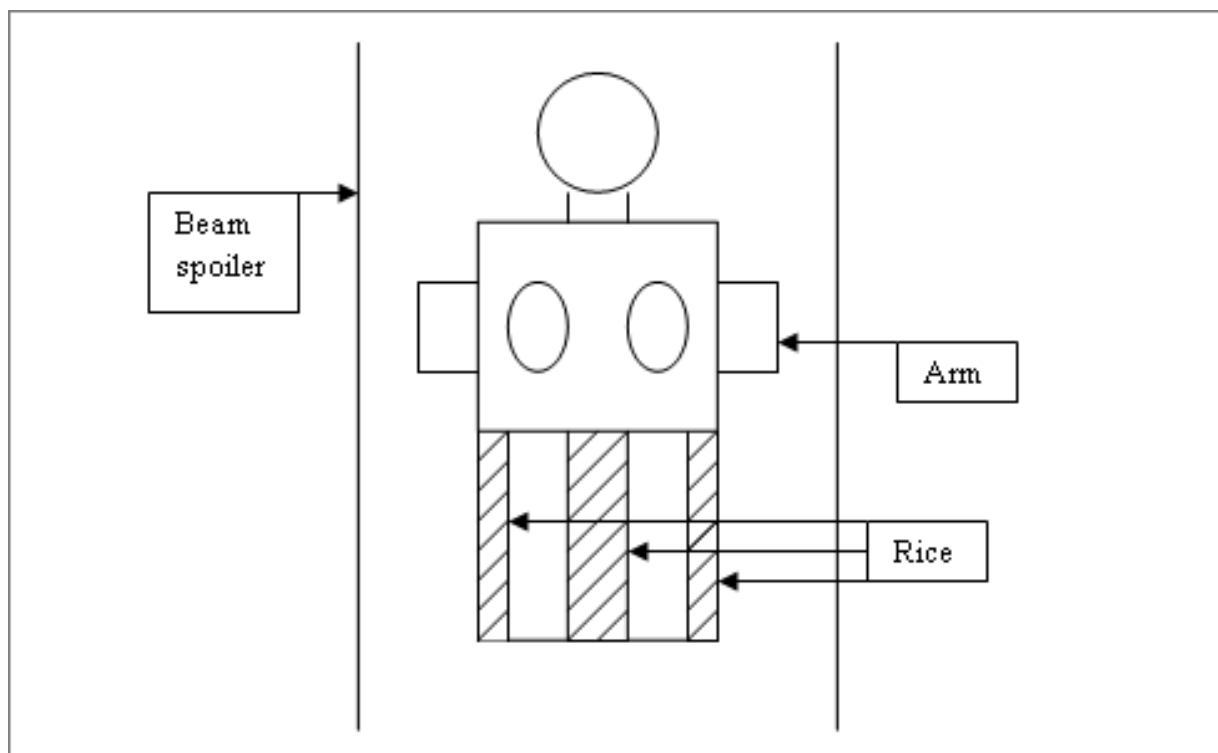

Fig. 3. Schematic of patient on TBI table with beam spoilers and rice bolus in place.

3.3 AP/PA TBI treatment stand

The opposed lateral field TBI table method does not allow for partial transmission blocking of the lung or liver as required by various protocols. Towards this goal, an alternative stand was developed to accommodate AP/PA field arrangement, cerrobend blocking, and verification of block placement in a reproducible and comfortable environment for the patient. The initial design of this stand utilized specifications described previously.^{6,7} Over the years, significant modifications to these designs have been made largely to accommodate weak patients who had difficulty standing for lengthy periods. The majority of patients presenting for TBI have received a chemotherapy regimen as a complementary preparation before the transplant.

The current version of the AP/PA TBI stand is pictured in Figure 4. Detailed drawings describing the construction of this stand are available from the authors to aid in duplicating this construction. The stand begins with a 29"(w)x29"(l)x27"(h) wooden platform. This height allows field coverage at the treatment distance with the accelerator gantry positioned at 272° and a collimator rotation of 45°. A patient rehabilitation walker was affixed to the platform after wheel removal. The cushioned arm supports can be positioned at varying levels to accommodate different patient heights.

A fabric harness is attached around the patient's waist and thighs. This harness is then attached with plastic buckles to the frame of the walker support. The harness system provides the patient significant stability and tolerance for the required lengthy standing time for this procedure. Patients have experienced episodes of significant weakness or even fainting and the harness system allowed potential injury to be avoided before care could be offered to the patient.

Additional patient support and comfort is provided by an adjustable bicycle seat attached to a slide affixed to the platform. The current seat arrangement represents the evolution from a seat supported from the platform rear to a single post from the platform middle. Other stools were investigated and rejected due to adjustment restrictions or beam attenuation.

The blocking support is attached to a portable beam spoiler (Fig. 5). The plastic spoiler is fabricated with 3/8" lexan polycarbonate and supported on a mobile assembly that is positioned directly in front of the patient after configuring the patient on the harness and stool. Angle iron is placed on the sides of the beam spoiler away from the beam to provide additional rigidity when the blocks are added. Again, detailed drawings are available from the authors upon request.

The cerrobend partial transmission blocks are affixed to a separate 1/4" lexan tray. The blocking tray is supported on a tray slot placed on each side of the beam spoiler. The thickness of the transmission blocks is calculated utilizing attenuation properties measured previously. The block thickness also varies with the patient separation and the desired transmitted dose, 8 or 10Gy. Typical thickness varies between 2-4cm of cerrobend and is determined using a simple spreadsheet calculation.

The positioning of the block is verified with imaging. In our case, we utilize the Kodak ACR 2000 CR system. However, a film cassette requiring chemical processing could also be used. Fig. 4 also shows a cassette holder attached to the rear of the platform. This spring-loaded cassette holder allows easy height adjustment and was obtained from a medical equipment reclamation service for less than \$50. If lateral adjustment in block placement is necessary after imaging, the blocking tray can be adjusted horizontally using a top-loaded bearing system. This adjustment provides +/- 7cm adjustment. Refer to the appendix for details. Two worm screws are added to the sides of the block assembly and vertical adjustment is accomplished by cranking up or down along this mechanism. After an acceptable image is obtained, the block shadow is traced onto the patient's surface for subsequent fractions.

As with the opposed lateral TBI treatment, the accelerator output rate is adjusted such that the midline dose rate is less than 10cGy/minute. Entrance and exit in-vivo dosimeters are placed to verify dose uniformity. Since the hands and forearms are not placed at the patient's side, but on the cushioned arm supports, there was a concern about dose uniformity in this region. Measurements confirm uniformity within +/- 5% as the hands and forearms are closer to the beam during the anterior field treatment and further from the beam during the posterior field delivery.



Fig. 4. Front view of TBI stand used for AP/PA fields.



Fig. 5. Front view of mobile spoiler and blocking mechanism used in conjunction with TBI stand.

3.4 Combination of treatment methods

Despite efforts to provide a comfortable treatment in the TBI stand, the opposed lateral TBI table still is viewed as the most comfortable for patients and easy to set up. Patients receiving TBI that requires dose reduction to the lungs and/or liver are treated using a combination of these two techniques. All current protocols requiring dose reduction to these organs require treatments to be administered over four days or 8 fractions. We routinely treat 4 fractions with the AP/PA TBI stand technique and 4 fractions with the opposed lateral TBI table option.

4. Radiobiological considerations for Total Body Irradiation

The techniques and methodology described in the previous section account for the physical criteria and limitations for the TBI procedure. The actual dose prescription and dose delivery schedule also play an important role in the success of the procedure (Shank, 1999). Normal lymphocytes are among the most radiosensitive cells and become profoundly depleted with TBI (Shank, 1999). In addition to finding that TBI was more immunosuppressive than CY, Shank describes early animal studies that found the degree of immunosuppression was a function of the total radiation dose. Dividing the treatment into multiple fractions over several days required an increase in total dose to achieve consistent results. Shank states the need for an increased dose over a fractionated schedule implies repair processes occurring between fractions.

Radiobiologists categorize the repair process from fractionated radiation treatments as repair, reoxygenation, redistribution and repopulation (Evans, 2000). In the context of TBI as applied to bone marrow transplantation, Evans states repair and repopulation are probably the most significant of these processes and can be best explained with a cell survival curve as shown in Figure 6. The slope of a survival curve can describe the radiation sensitivity of a particular cell type. The slope of the curve, termed D_0 and the shoulder region, termed D_q , quantify significant parameters of a cells response to radiation. Cells from different tissues have different D_0 's and D_q 's as illustrated in Figure 6.

It has been generally accepted that a small shoulder (D_q) is typical of bone marrow stem cells and leukemia cells (Evans, 2002). Therefore, these cells have a limited ability to repair damage. In contrast, cells of lung tissue and intestinal epithelial cells have survival curves with must broader shoulders (D_q), implying a greater repair capacity. The second important repair process is repopulation. Evans defines repopulation as the proliferation of cells between dose fractions. Rapidly dividing tissues, like the intestine, can increase their normal proliferation rate after a radiation treatment. Slowly dividing tissues such as the lung and vascular tissues tend not to proliferate at a higher rate after radiation. Therefore, during a fractionated radiation therapy regimen, Evans speculates that both repair and repopulation may occur between fractions. Repair of the leukemia cells is minimal. The separation of the leukemia cell survival curve from the lung cell survival curve increases the therapeutic ratio and supports fractionation. Shank (1998) attempted to calculate the optimal TBI schedule including fraction dose, number of fractions, and total dose. In addition, Shank reviews some clinical trials with regards to percentage relapse with different TBI schedules. Shank summarizes her findings that the greatest leukemia cell kill with minimum morbidity will occur with a highly fractionated radiotherapy regimen. A total dose of 1400-1500 cGy delivered over 10-13 fractions may be optimal.

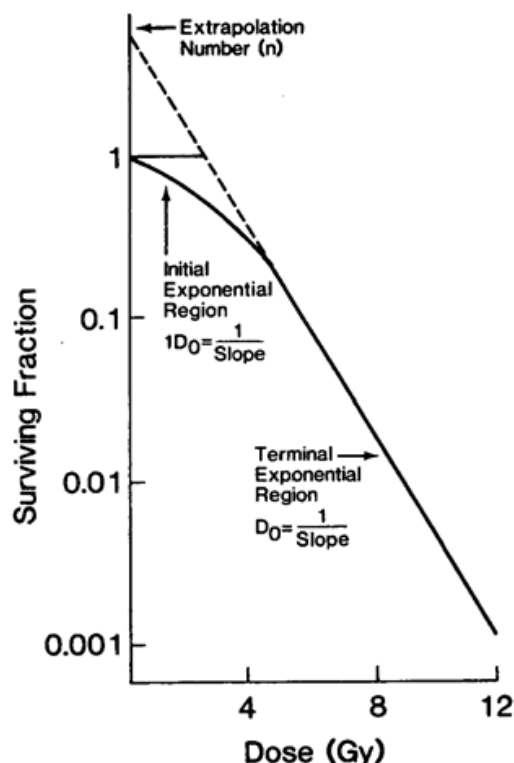

Fig. 6. A typical survival curve for mammalian cells exhibiting an initial shoulder followed by an exponential region. An initial shoulder characterizes the curve with some slope to it ($1D_0$), the exponential slope (D_0), n (extrapolation number) and D_q .

5. Effectiveness of TBI for various leukemias

Leukemia is a broad classification for several types of this disease. This variety of leukemias differs based on pathological examination of cell definition. Bredeson et al. (2002) provide a summary and results of clinical trials including TBI. Patients with acute myeloid leukemia (AML) have shown to be fairly responsive to stem cell transplants with TBI preparation. Results of randomized studies comparing TBI containing regimens with total chemotherapy preparatory regimens indicate a 75% actuarial survival with TBI compared to 51% without. Relapse rates are lower with the TBI regimens as well. 14% relapsed within 2 years with TBI while 34% relapsed under chemotherapy regimens.

Bredeson et al. (2002) reports acute lymphoblastic leukemia (ALL) results show significant improvement with TBI regimens. 52% disease-free survival rates are reported when TBI is utilized as compared to 37% with chemotherapy alone. The percentage relapse is nearly identical from both types of regimens. Studies of treatments for chronic myeloid leukemia patients show fairly high yet identical disease-free survival rates. Nearly 80% survival rates were reported for both protocols. Relapse rates were indistinguishably different.

6. Discussion and summary

Leukemia is a disease classification for an imbalance within the hemopoietic system. Acute leukemias are characterized with unregulated cell growth while chronic leukemias exhibit incomplete maturation of cells and some increase proliferation. Bone marrow or stem cell transplantation is a viable treatment option for the leukemia patient. Stem cells collected

from an HLA matching donor or cells collected from the patient while in remission are provided to the leukemia recipient. The clinical desire of the transplant is repopulation and re-growth of the stem cells triggering a balanced regulated hemopoietic system.

Preparative regimens for marrow transplantation are required to rid the leukemia patient of any microscopic disease. Rigorous protocols of chemotherapy or radiation therapy combined with chemotherapy are provided prior to transplantation to reduce relapse. Radiotherapy includes fractionated treatments delivered to the total body (TBI). TBI treatments pose several concern issues in methodology and fractionation. High-energy fields with opposing beam arrangements lead to improved dose uniformity. Acrylic plates can serve as beam spoilers to increase the dose to an adequate dose for shallow depths. The lung tissue is sensitive to radiation and limits the dose delivered to the rest of the body. Accurate lung dose calculations are necessary to determine if attenuators are necessary to reduce the total lung dose. Fractionation of the TBI dose requires an increase in the total dose delivered as repair and repopulation occurs between fractions. Repair processes are minimal for the leukemia cell and therefore the therapeutic ratio is enhanced. Analysis of the disease-free survival rates and evaluation of the percentage of patients relapsing or recurring measure the effect of these preparatory regimens. TBI shows a marked improvement in both factors for AML and ALL. Studies reviewing the effects of treatments for CML show excellent results for both chemotherapy only protocols and TBI-chemotherapy combined protocols.

Over the last 35 years, TBI delivery protocols have evolved due to toxicity concerns. Radiation-induced toxicity is influenced by the dose rate and total dose. The total dose was predominantly restricted by pulmonary toxicity from interstitial pneumonitis. Single fraction TBI was replaced with fractionated and hyperfractionated techniques. Radiobiological principles of preferential normal tissue repair with fractionation forecast improved anti-leukemic effects without increasing toxicity. Dose rate was considered a strong factor in the causation of interstitial pneumonitis and most protocols restrict the delivery dose rate to less than 10 cGy/min. TBI protocols vary with the primary malignancy and complementary chemotherapy conditioning regimen. Current TBI protocols include: a single fraction of 200 Gy; two BID fractions of 2 Gy/fraction; eight BID fractions of 1.5 Gy/fraction with or without lung and liver dose reduction to 8-10 Gy; and eight BID fractions of 1.65 Gy/fraction with or without partial transmission blocking of the lung and liver.

Factors influencing large field treatment technique choice include dose homogeneity, accurate and reproducible delivery, ease of set up, treatment room limitations, and the treatment protocol used. For example, if a reduced organ dose is required with blocking, an AP/PA treatment technique is required. Different techniques have been described recently including those utilizing tomotherapy or translational couch options. Two methods of comfortable total body irradiation using conventional linear accelerators without machine modifications are presented here. A technique for lateral treatments and a process for AP/PA treatments with blocking are described. Techniques described here enhance other reported design specifications. The technique options represent an evolution in our process and should aid facilities looking to begin a TBI program or facilities desiring modifications to adjust to different treatment protocols.

Dose uniformity is the primary criterion when creating a treatment technique. The use of beam spoilers, strategically placed bolus, missing tissue compensators, and opposed fields with high energy x-rays will accomplish the uniformity goal. While dose uniformity is the major priority in developing a suitable treatment technique, patient comfort and support are equally important. Patients presenting for TBI are often weak and recovering from other

chemotherapy treatments as part of the preparatory program for transplant. Two treatment options, opposed laterals and AP/PA fields and associated apparatus have been presented. The limitation of dose delivered to the lung/liver is specified in several protocols and is accomplished with partial transmission blocks placed in conjunction with AP/PA fields. Both techniques were designed to insure accurate dose delivery, comfortable patient support, and easy patient setup. Calculation spreadsheets referenced in this manuscript are available by contacting the authors.

7. Appendix

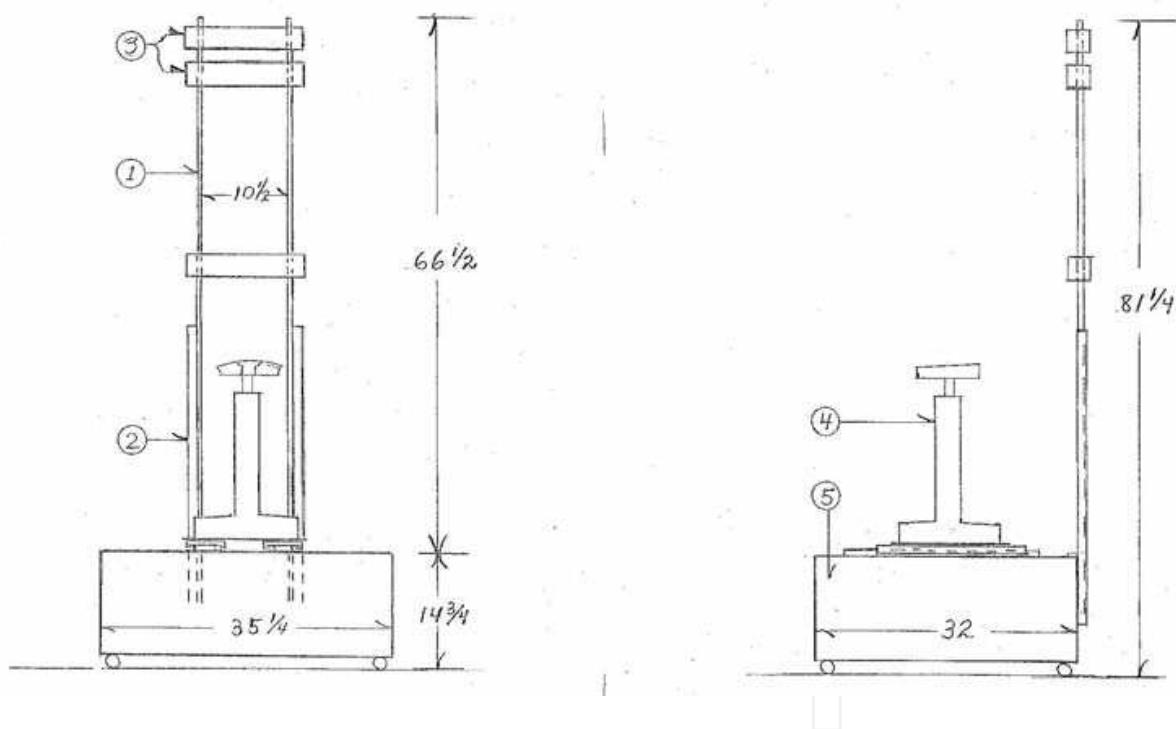

Legend: 1. $\frac{5}{8}$ " stainless steel rod, 2. Angle iron for stabilization and support, 3. Adjustable cassette holder, 4. Double track system support for bicycle seat placement, 5. Platform with $\frac{3}{4}$ " plywood on oak framework

Fig. A-1 Front and side view of AP/PA stand .

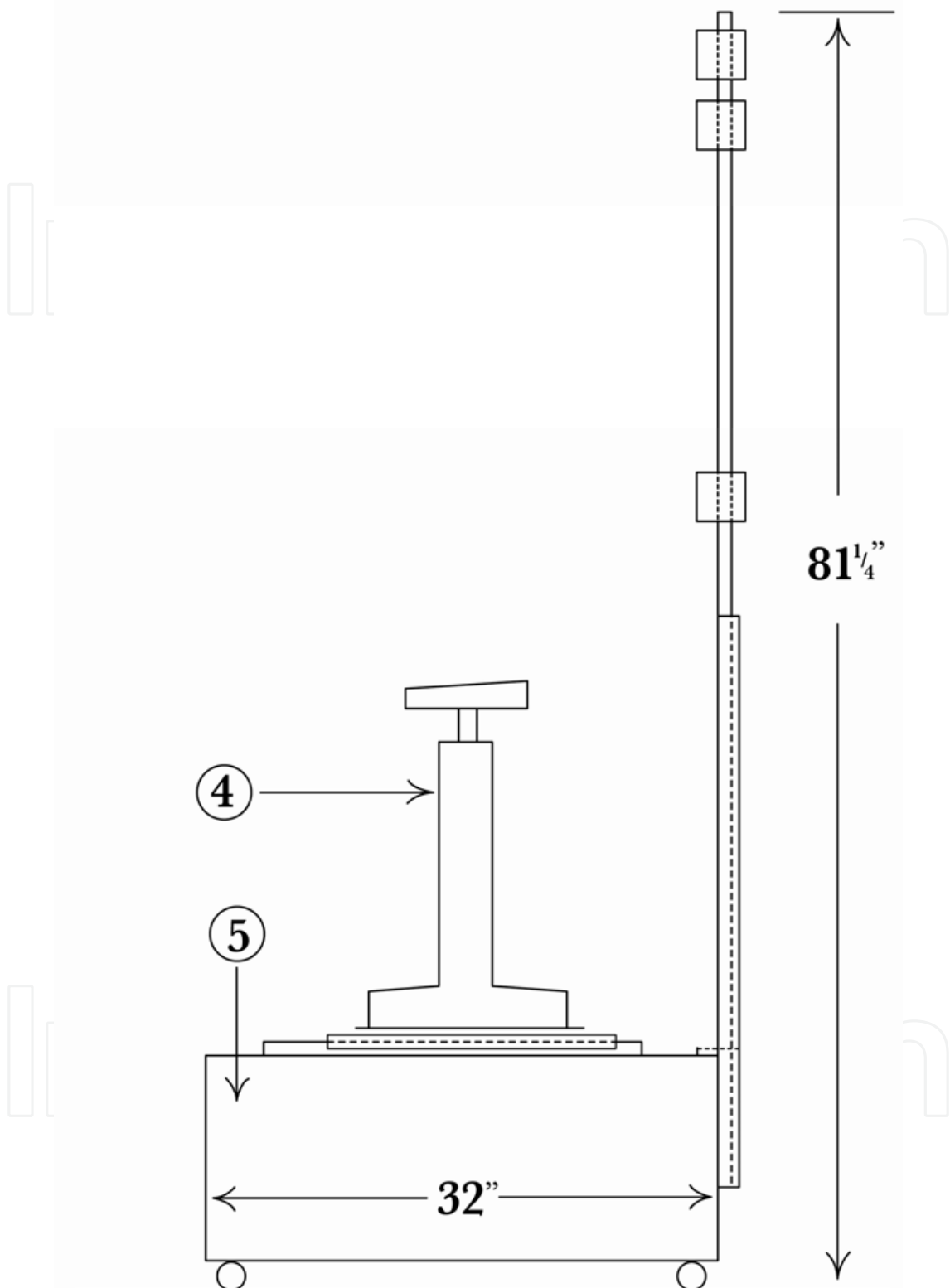

Legend: 1. 5/8" stainless steel rod, 2. Angle iron for stabilization and support, 3. Adjustable cassette holder, 4. Double track system support for bicycle seat placement, 5. Platform with 3/4" plywood on oak framework

Fig. A-2 AP/PA Stand Side View

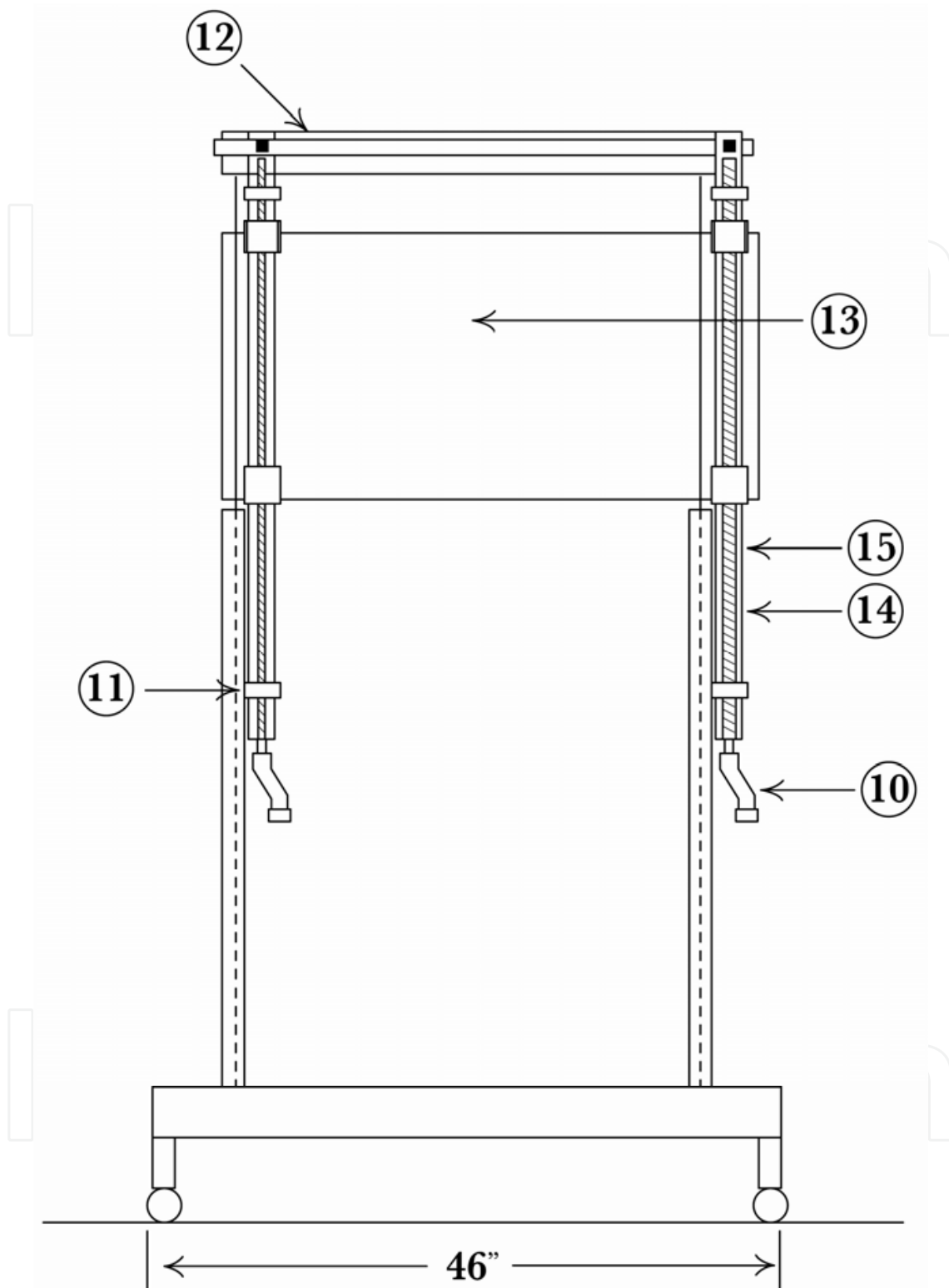

Legend: 6. 1-1/2"x3-1/2" Oak frame support, 7. Lexan beam spoiler, 8. Support for block tray with galvanized metal support, 9. Galvanized metal lock, 10. Crank, 11. Bearing location & cap (2 bearings/crank), 12. Ball bearing track for horizontal block adjustment, 13. 1/4" block tray, 14. 7/16" thread rod, 15. 1/4" channel for rod adjustment system

Fig. A-3 AP/PA Beam Spoiler and Blocking Support Front View

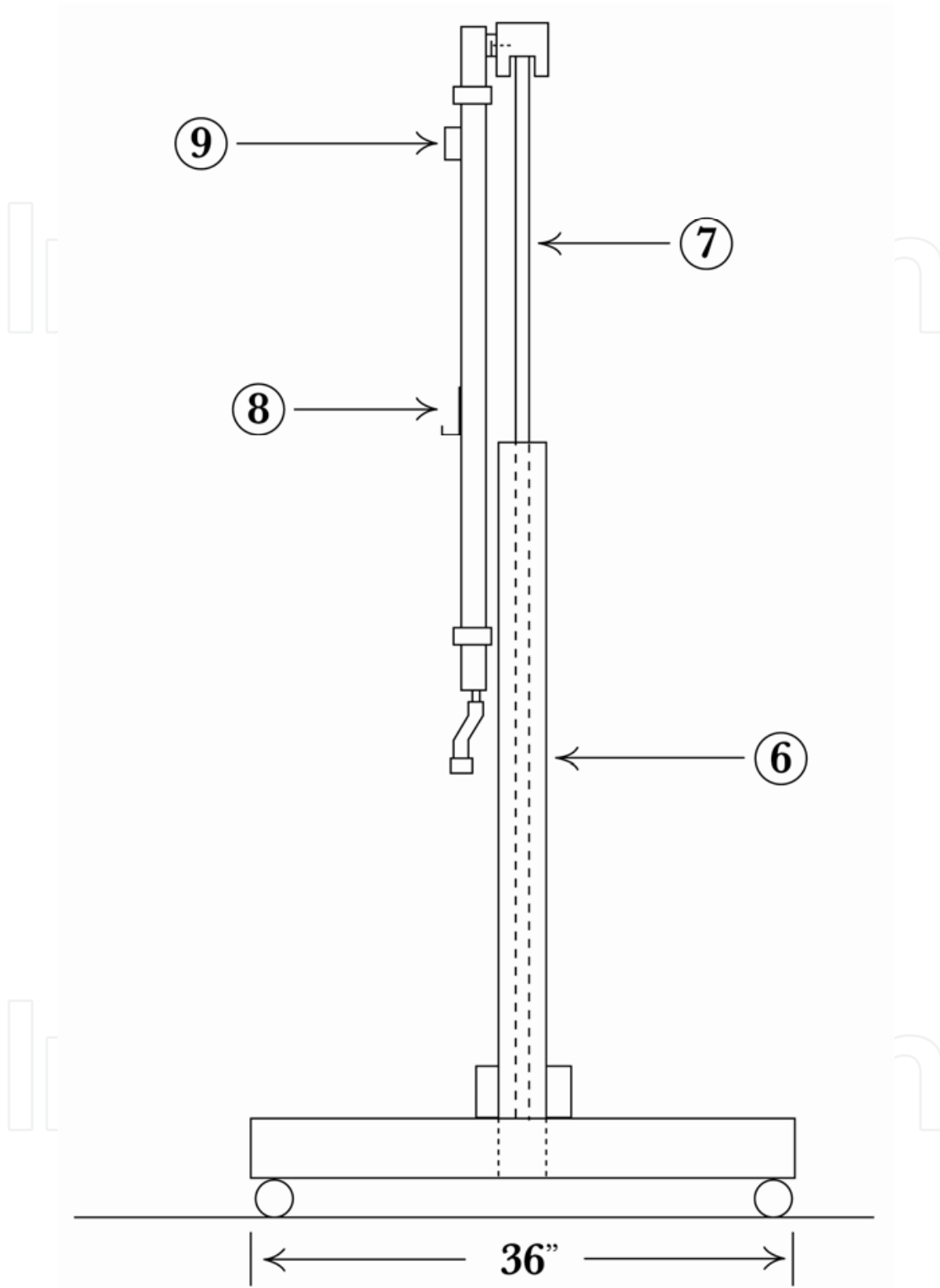

Legend: 6. 1-1/2"x3-1/2" Oak frame support, 7. Lexan beam spoiler, 8. Support for block tray with galvanized metal support, 9. Galvanized metal lock, 10. Crank, 11. Bearing location & cap (2 bearings/crank), 12. Ball bearing track for horizontal block adjustment, 13. 1/4" block tray, 14. 7/16" thread rod, 15. 1/4" channel for rod adjustment system

Fig. A-4 AP/PA Beam Spoiler and Blocking Support Side View

8. Acknowledgement

The authors express their gratitude to Craig Nicholson for his thoughtful efforts and insight in the construction of the AP/PA stand and the beam spoiler/block support system.

9. References

- Bentel, G. (1992). *Radiation Therapy Planning* (4th ed.). New York, NY: Macmillan.
- Bradley, J., Reft, C., Goldman, S., Rubin, C., Nachman, J., Larson, R., et al. (1998). High-energy total body irradiation as preparation for bone marrow transplantation in leukemia patients: treatment technique and related complications. *International Journal of Radiation Oncology, Biology and Physics*, 40, 391-396.
- Bredeson, C., Perry G., Martens C., McDiarmid S., Bence-Bruckler, I. Atkins, H., et al. (2002). Outpatient total body irradiation as a component of a comprehensive outpatient transplant program. *Bone Marrow Transplantation*, 29, 667-671.
- Corns, R., Evans, M., Olivares M., Syke, L., & Pogorsak, E. (2000). Designing attenuators for total body irradiation using virtual simulation. *Medical Dosimetry*, 25, 27-31.
- Evans, R. (2000). Radiobiological considerations in magna-field irradiation. *International Journal of Radiation, Oncology, Biology and Physics*, 43, 1907-1911.
- Galvin, J., D'Angio, G., & Walsh, G. (1999). Use of tissue compensators to improve dose uniformity for total body irradiation. *International Journal of Radiation Oncology, Biology and Physics*, 42, 767-771.
- Lin, J., & Chu, T. (2001). Dose compensation of the total body irradiation therapy. *Applied Radiation Isotopes*, 55, 623-630.
- Lindsley, K. & Deeg, H.J. (1998). Total body irradiation for marrow or stem-cell transplantation. *Cancer Investigation*, 16, 424-425.
- Serota, F., Burkey, E., August, C., & D'Angio, G. (1998). Total body irradiation as preparation for bone marrow transplantation in treatment of acute leukemia and aplastic anemia. *International Journal of Radiation Oncology, Biology and Physics*, 12, 1941-1949.
- Shank, B. (1999). Techniques of magna-field irradiation. *International Journal of Radiation Oncology, Biology and Physics*, 42, 1925-1931.
- Shank, B. (1998). Total body irradiation for marrow or stem-cell transplantation. *Cancer Investigation*, 16, 397-404.
- Scheinberg, D., Maslak, P., & Weiss, M. (2001). Acute leukemias. In V.T. DeVita & S. Hellman & S. Rosenberg (Eds.), *Cancer-Principles and Practice of Oncology*, (6th ed.), (pp. 2404-2432). Philadelphia, PA: J.B. Lippincott.
- Urbano-Ispizua, A., Schmitz, N., de Witte, T., Frassoni, F., Rosti, G., Schrezenmeier, H., et al. (2002). Allogenic and autologous transplantation for hematologic diseases, solid tumors, and immune disorders: definitions and current practice. *Bone Marrow Transplantation*, 29, 639-646.

Van Dyk, J. (2000). Magna-field irradiation: physical considerations. *International Journal of Radiation Oncology, Biology and Physics*, 43, 1913-1918.

IntechOpen

IntechOpen



Advances in Cancer Therapy

Edited by Prof. Hala Gali-Muhtasib

ISBN 978-953-307-703-1

Hard cover, 568 pages

Publisher InTech

Published online 21, November, 2011

Published in print edition November, 2011

The book "Advances in Cancer Therapy" is a new addition to the InTech collection of books and aims at providing scientists and clinicians with a comprehensive overview of the state of current knowledge and latest research findings in the area of cancer therapy. For this purpose research articles, clinical investigations and review papers that are thought to improve the readers' understanding of cancer therapy developments and/or to keep them up to date with the most recent advances in this field have been included in this book. With cancer being one of the most serious diseases of our times, I am confident that this book will meet the patients', physicians' and researchers' needs.

How to reference

In order to correctly reference this scholarly work, feel free to copy and paste the following:

Brent Herron, Alex Herron, Kathryn Howell, Daniel Chin and Luann Roads (2011). Photon Total Body Irradiation for Leukemia Transplantation Therapy: Rationale and Technique Options, *Advances in Cancer Therapy*, Prof. Hala Gali-Muhtasib (Ed.), ISBN: 978-953-307-703-1, InTech, Available from: <http://www.intechopen.com/books/advances-in-cancer-therapy/photon-total-body-irradiation-for-leukemia-transplantation-therapy-rationale-and-technique-options>

INTECH
open science | open minds

InTech Europe

University Campus STeP Ri
Slavka Krautzeka 83/A
51000 Rijeka, Croatia
Phone: +385 (51) 770 447
Fax: +385 (51) 686 166
www.intechopen.com

InTech China

Unit 405, Office Block, Hotel Equatorial Shanghai
No.65, Yan An Road (West), Shanghai, 200040, China
中国上海市延安西路65号上海国际贵都大饭店办公楼405单元
Phone: +86-21-62489820
Fax: +86-21-62489821

© 2011 The Author(s). Licensee IntechOpen. This is an open access article distributed under the terms of the [Creative Commons Attribution 3.0 License](#), which permits unrestricted use, distribution, and reproduction in any medium, provided the original work is properly cited.

IntechOpen

IntechOpen