

# We are IntechOpen, the world's leading publisher of Open Access books Built by scientists, for scientists

4,900

Open access books available

124,000

International authors and editors

140M

Downloads

Our authors are among the

154

Countries delivered to

TOP 1%

most cited scientists

12.2%

Contributors from top 500 universities



WEB OF SCIENCE™

Selection of our books indexed in the Book Citation Index  
in Web of Science™ Core Collection (BKCI)

Interested in publishing with us?  
Contact [book.department@intechopen.com](mailto:book.department@intechopen.com)

Numbers displayed above are based on latest data collected.  
For more information visit [www.intechopen.com](http://www.intechopen.com)



# Experimental Evaluation of the Mechanical Strength of the Stapling Techniques: Experimental Study on Animal Model

Kentaro Kawasaki<sup>1</sup>, Kiyonori Kanemitsu<sup>2</sup>,  
Tadahiro Goto<sup>2</sup>, Yasuhiro Fujino<sup>1</sup> and Yoshikazu Kuroda<sup>2</sup>

<sup>1</sup>*Division of Gastroenterological Surgery, Hyogo Cancer Center, Akashi, Hyogo*

<sup>2</sup>*Division of Gastroenterological Surgery  
Kobe University Graduate School of Medicine, Kobe  
Japan*

## 1. Introduction

The creation of a gastrointestinal tract anastomosis is a fundamental and important surgical procedure. The mean incidence of clinically apparent leakage after gastrointestinal tract anastomosis ranges from 2.1% to 14.9%. Although many techniques for successfully producing such anastomoses have been described, the goal of these techniques to be technically feasible and safe.

In the 1960s, Steichen and Ravitch introduced stapling instruments. During the subsequent years, automatic stapling instruments have continued to be refined, and many automatic anastomotic techniques have been applied to gastrointestinal surgery. In addition, various instruments and techniques for stapling intestinal anastomoses have been applied to colorectal surgery. Functional end-to-end anastomosis (FETEA), stapled end-to-end anastomosis (ETEA), and stapled side-to-end anastomosis (STEA) are the most common techniques. Moreover, there are two types of stapled ETEA, the single stapling technique (SST) and the double stapling technique (DST).

Although these methods have been shown to be reliable and safe, anastomosis leakage remains a major problem. Major leakages affect the long-term quality of life (QOL) of patients. In addition, leakage can cause significant morbidity. Studies have reported that the frequency of leakage ranges from 2.9 to 23%, and that the shorter the distance from the anal verge to the anastomosis the greater the risk of leakage.

As mentioned above, automatic stapling instruments have been refined over the years, and many automatic anastomotic techniques have been applied to colorectal surgery; however, the optimal instrument and method remain unclear. Since the mechanical strength of an anastomosis is an important factor affecting leakage during the initial postoperative phase, experimental evaluation of this factor would be useful for clarifying these issues.

In this chapter, we examined the pressure required to induce failure (bursting pressure) in various kinds of stapled anastomosis and investigated which stapling technique is most suitable.

## 2. Materials and methods

### 2.1 Materials

All animal experiments were carried out according to the “Guidelines for Animal Experimentation at COVIDIEN, Japan”. Young domestic pigs (10-12 weeks) weighing 30 to 40 kg were used in this study. After the induction of general anesthesia using intramuscular ketamine (15 mg/kg) and intravenous pentobarbital (30 mg/kg), the pig was intubated and maintained on mechanical ventilation. An intravenous catheter was then placed in the right external jugular vein, and the animal was given approximately 500 ml isotonic intravenous fluid. After making a midline incision, segments of the small intestine were isolated and transected. All specimens were maintained in warm natural saline and randomly allocated to the following anastomotic techniques.

After the experiments, the animals were sacrificed under anesthesia using intravenous potassium chloride.

### 2.2 Surgical procedure

The stapled anastomoses were created using the EndoGIA 60 blue, EndoGIA60 green, GIA 60 blue, or PCEEA 21 (COVIDIEN, Japan). The characteristics of each device are summarized in Table 1. All anastomoses were performed by an expert surgeon.

Instrument	Staple	Thickness (mm)
EndoGIA blue <sup>®</sup>	3 lines	1.5
EndoGIA green <sup>®</sup>	3 lines	2
GIA Blue <sup>®</sup>	2 lines	1.5

Table 1. Comparison of instruments

### 2.3 Examination of bursting points and pressure

A 16-Fr Foley catheter was placed into the lumen of the transected small intestine, and a balloon was inflated to close the lumen (Figure 1). The schema was described as Figure 2.

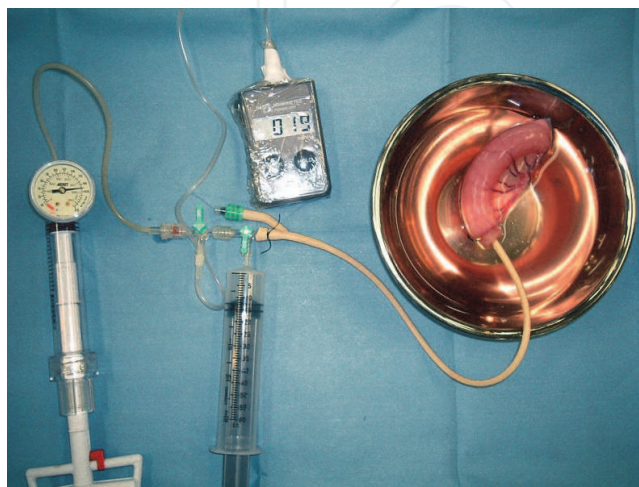

Fig. 1. System used in this chapter

The balloon catheter was then connected to an infusion pump and a pressure recorder (Pressure Sensors PG-100, COPAL ELECTRONICS) via a pressure transducer. Each anastomosis was immersed in water, and air was infused into the intestine at a rate of 30mL/min. The intraluminal pressure was continuously recorded. The bursting pressure was defined as the pressure at which air leakage from the anastomosis was initially observed (Figure 3). The location of the bursting point was also recorded.

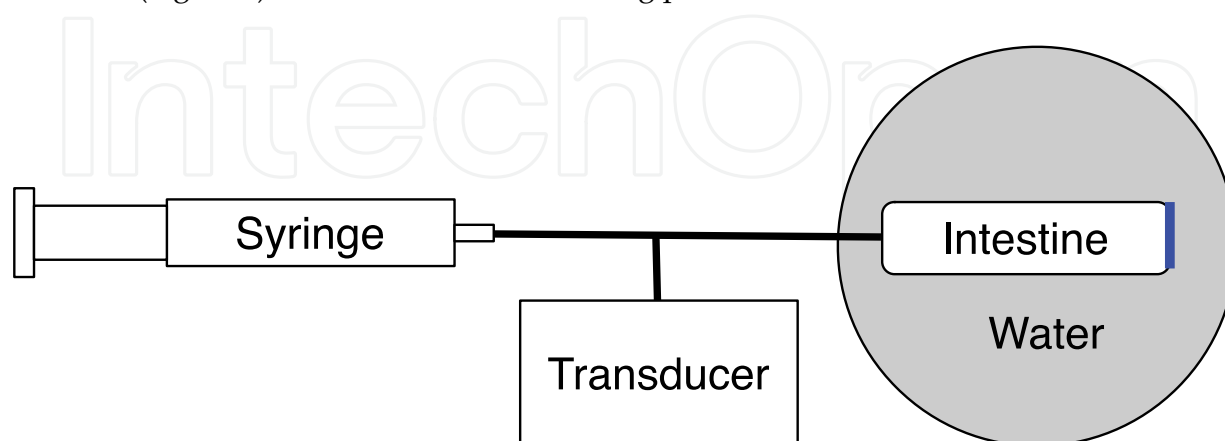

Fig. 2. Measurement of Bursting Pressure and Bursting Point



Fig. 3. The moment air leakage was seen

#### 2.4 Statistical analysis

Discrete variables were analyzed using the Mann-Whitney test, Factorial Analysis of Variance (ANOVA), and Scheffe's test. Statistical significance was indicated at  $P < 0.05$ . All statistical computations were carried out using StatView5.0 software.

### 3. Experiment

#### 3.1 Experiment 1: Comparison of the bursting pressure of anastomoses produced using various instruments

##### 3.1.1 Method

A segment of the intestine was isolated using the EndoGIA 60 blue, EndoGIA 60 green, or GIA 60 blue. Then, the bursting pressures of the staple lines produced using each instrument were examined. Three sets of each staple line were examined.

##### 3.1.2 Result

The bursting pressure of anastomoses produced using the EndoGIA 60 blue was significantly higher than that of those produced using the EndoGIA 60 green or GIA 60 blue (Table 2).

Instrument	Pressure (mmHG)	<i>p</i>
EndoGIA blue®	80.3 <i>S.D.</i> 10.5	
EndoGIA green®	37.3 <i>S.D.</i> 4.2	<0.01 VS EndoGIA blue®
GIA blue®	31.7 <i>S.D.</i> 4.5	<0.01 VS EndoGIA blue®

Table 2. Comparison of bursting pressure of instruments

#### 3.2 Experiment 2: Comparison of the bursting pressure of buttressed and non-buttressed cutting sites

##### 3.2.1 Method

After isolating the intestine with the EndoGIA 60 blue, the cut end of the staple line was buttressed with 3-0 silk serosa-muscular sutures (Figure 4). Then, the bursting pressure of each type of anastomosis was measured.

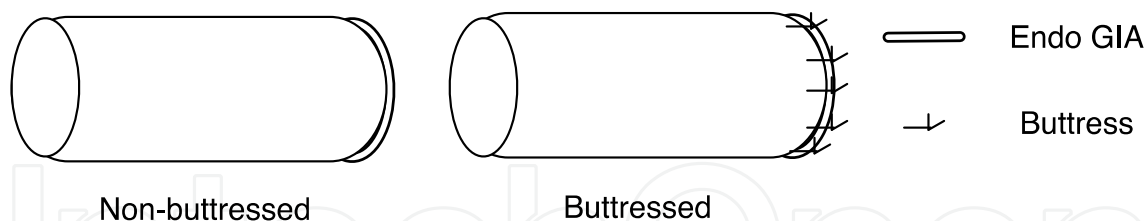

Fig. 4. Comparison of buttressed and non-buttressed cutting sites

##### 3.2.2 Result

Comparison of the bursting pressures of buttressed and non-buttressed cutting sites. The bursting pressure of the buttressed group was significantly higher than that of the non-buttressed group (Table 3).

Groups	Pressure (mmHG)	<i>p</i>
buttressed	149.6 <i>S.D.</i> 37.6	< 0.01
non-buttressed	75.3 <i>S.D.</i> 25.1	

Table 3. Comparison of bursting pressure of buttressed

**3.3 Experiment 3: Comparison of the bursting pressures of the three kinds of the anastomosis (FETEA, STEA and ETEA).**

**3.3.1 Method**

FETEA was performed using the EndoGIA 60 blue, ETEA was performed using the PCEEA circular stapler, and STEA was performed using the PCEEA circular stapler or the EndoGIA 60 blue. Then, the bursting pressure and points of each anastomosis were examined. Three or four sets of each anastomosis were examined.

**3.3.2 Result**

The bursting pressure was not significantly different between the three groups (Table 4). FETEA failed at the intersection of the stapled lines or the crotch of the anastomosis or both. All stapled ETEA failed along the staple line. All stapled STE anastomoses failed along the circular staple line (Figure. 5).

Anastomosis	Pressure (mmHG)	<i>p</i>
FETEA	28.3 S.D. 6.8	
STEA	17.3 S.D. 6.4	N. S.
ETEA	19.8 S.D. 7.4	

Table 4. Comparison of FETEA, ETEA and STEA

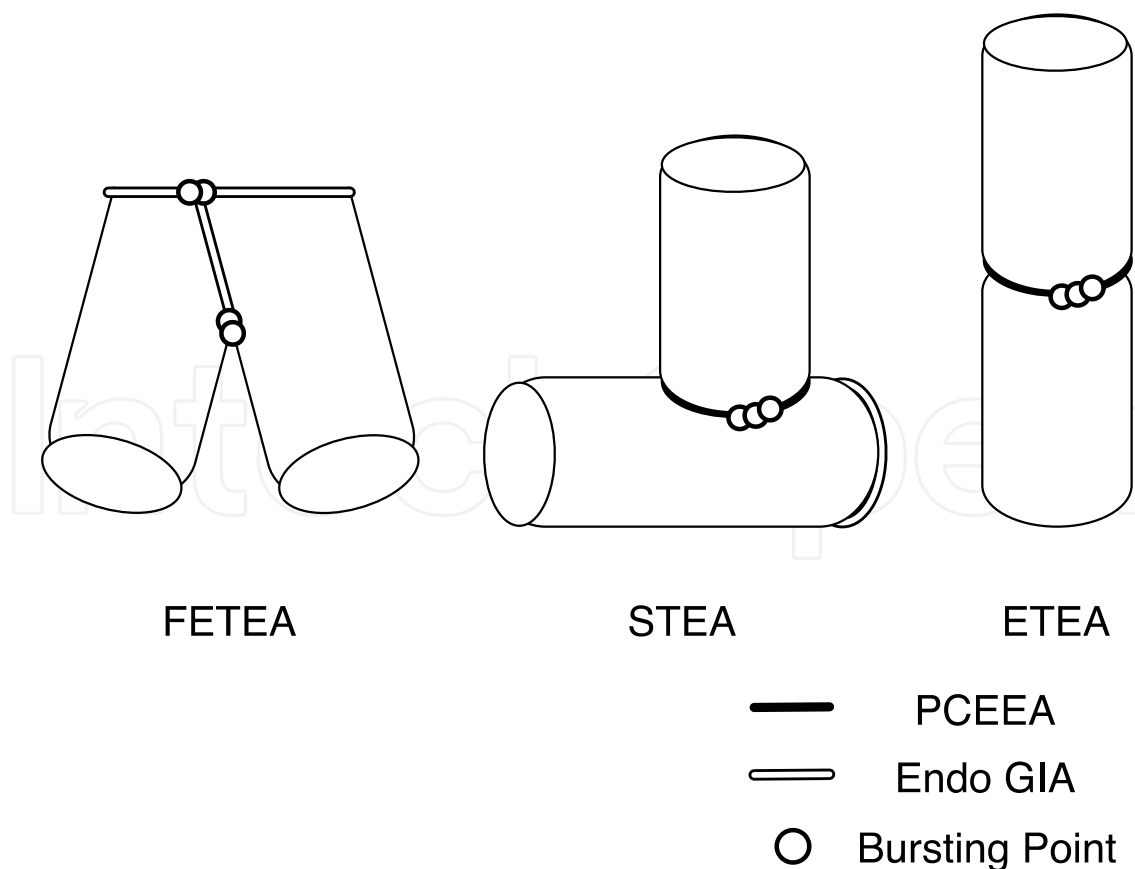

Fig. 5. Bursting points of FETEA, STEA and ETEA

### 3.4 Experiment 4: Comparison of the bursting points and the bursting pressure between the SST, DST, and DST with buttressing techniques

#### 3.4.1 Method

SST was performed with the PCEEA21, and DST was performed with the EndoGIA 60 blue or PCEEA21. In addition, buttressing of the staple line with 3-0 silk sutures was performed in combination with DST (DST + buttressing). Then, the bursting pressure and bursting points of each anastomosis were measured.

#### 3.4.2 Result

The bursting points of the anastomoses are shown in Figure 3a. Eight bursting points were located at staple line intersections in the anastomoses created using the PCEEA, while only one bursting point was located at a staple line intersection in the anastomoses created using the PCEEA and EndoGIA (black circle). Bursting pressure was not significantly different between the three groups (Table 5). However, the bursting pressure of the staple line intersection (black circle) was much lower than those of the others (Figure 3b).

Anastomosis	Pressure (mmHG)	<i>p</i>
SST	34.0 <i>S.D.</i> 3.6	
DST	30.7 <i>S.D.</i> 14.5	N. S.
DST with buttressing	39.3 <i>S.D.</i> 11.9	

Table 5. Comparison of SST, DST, and DST with buttressing

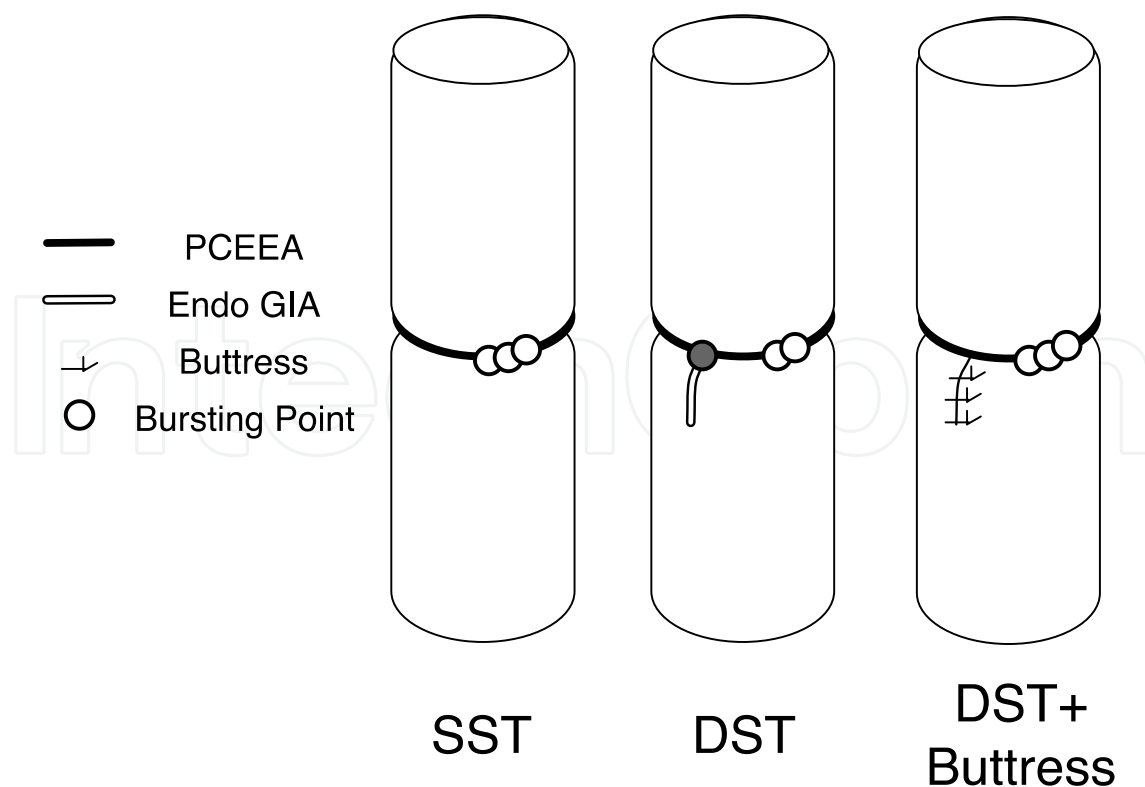

Fig. 6a. Bursting Point

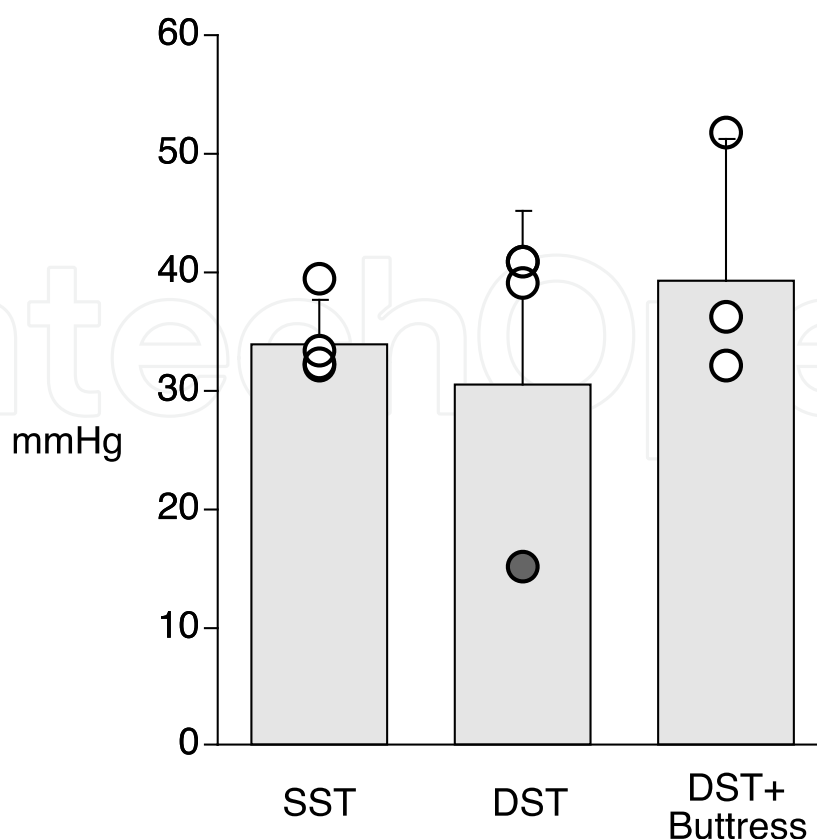

Fig. 6b. Bursting Pressure

#### 4. Discussion

In choosing the best anastomotic technique, surgeons should consider the features and limitations of each technique, rather than their experience or preference. Unfortunately, no matter how safe stapling instruments have become, they are unlikely to ever become risk-free. The consequences of these instruments misfiring can be significant. In addition, complications can occur even when the instruments function normally. Anastomotic failure depends on various parameters, including tissue thickness, collagen content, blood flow, improper selection of staple cartridges, ischemia, and tension.

The most common problem associated with intestinal anastomoses is leakage. The bursting pressure of an anastomosis reflects its strength, and higher bursting pressure correlates to a stronger anastomosis at less than one week after surgery. Leakage also appears to be closely connected with the strength of a freshly completed intestinal anastomosis. Therefore, bursting pressure is considered to be the most important factor for assessing the quality of an intestinal suture line.

In experiment 1, the EndoGIA blue produced the strongest anastomoses. The bursting pressure of the anastomoses produced using this device was approximately twice as high as that of those produced using the EndoGIA green and GIA blue. This suggests that anastomotic strength is regulated by the number of staple lines and the relationship between the device and tissue thickness. Thus, experiment 2 was performed using the EndoGIA blue. Experiment 2 demonstrated that buttressing the cutting site significantly increased the strength of the anastomosis. Therefore, buttressing the staple line to strengthen it seems to be effective.



In experiment 3, the FETEA, STEA and SSTA techniques were compared. The results of the present study demonstrate that none of the anastomotic techniques was superior to the others as far as bursting pressure was concerned. The bursting point was located along the staple line in anastomoses created using the PCEEA and at the intersection of the stapled lines or the crotch of the anastomosis in those produced using the EndoGIA, which could have caused leakage to occur. In our experiments, when the anastomotic crotch was buttressed, the bursting pressure was significantly increased. In particular, in automatic anastomoses, the locations where staple lines cross might be weak points.

In experiment 4, the SST, DST, and DST with buttressing techniques were compared. There were no significant differences between these three groups with regard to bursting pressure. However, the staple lines created by the PCEEA were weaker than those produced using the EndoGIA. This may have been due to the fact that the EndoGIA creates 3 staple lines, in contrast to the 2 lines produced by the PCEEA. If a 2-line stapler (e.g. the GIA or TA) is used to isolate the intestine, bursting might occur along the staple line. Therefore, 3-line staplers (e.g., the EndoGIA) are more useful for isolating the intestine.

In experiment 4, the bursting points of the anastomoses were also examined. In 8 of 9 PCEEA cases, the bursting points were located at staple line intersections, and all bursting pressure values were above 30mmHg. In contrast, only one bursting point occurred at a staple line intersection in the anastomoses created using both the PCEEA and EndoGIA; moreover, its bursting pressure was only 14mmHg. While bursting may be a rare event, it can cause leakage or infection during the initial postoperative phase because intra-anal pressure has been reported to reach 24-73 mmHg. Therefore, the SST technique, which does not create staple line intersections, may be the safest method. Although the DST with buttressing is sometimes performed, it did not significantly increase the strength of the anastomosis. Therefore, this technique may be fairly useless. In this experiment, the buttressing of anastomoses produced using the PCEEA was not examined since buttressing a PCEEA produced anastomosis is impossible during lower rectal cancer surgery.

The above stapling techniques have been accepted widely for the treatment of rectal cancer. However, complications can occur, and when they do, they reduce the patient's QOL. These data are relevant to acute phase conditions and were derived from an animal model so they may not completely reflect human clinical data. However, animal experimental evaluations are often found to be useful by gastroenterological surgeons. Although many factors influence anastomotic healing, our results may help to decrease the incidence of postoperative complications after the creation of a gastrointestinal tract anastomosis.

## 5. Conclusion

The EndoGIA blue is the most suitable device for stapling intestinal anastomoses. Buttressing the stapling line may increase the strength of the anastomosis. The stapling line intersection might be a weak point, especially when the DST technique is used. Although our findings relate to acute phase conditions and were derived from a small number of anastomoses in an animal model, we believe that gastro-enterological surgeons will find our results useful.

## 6. Acknowledgment

We thank COVIDIEN Japan for the technical support.

## 7. References

- Rullier E, Laurent C, Garrelon JL & Michel P. (1998). Risk factors for anastomotic leakage after resection of rectal cancer. *Br J Surg* 85: 355–358, ISSN 1365-2168
- Schwab R, Wesendorf S, Gutcke A & Becker HP. (2002). Early bursting strength of human colon anastomoses: an in vitro study comparing current anastomotic techniques. *Langenbeck Arch Surg* 386: 507–511, ISSN 0272-5533
- Steichen FM. (1968). The use of staplers in anatomical side-to-side and functional end-to-end enteroanastomoses. *Surgery* 64: 948–953, ISSN 0039-6060
- Hardcare JM, Mendoza-Sagaon M, Murata K & Talamini MA. (2000). Use of a cauterizing laparoscopic linear stapler in intestinal anastomosis. *Surg Laparosc Endosc Percutan Tech* 10: 128–132, ISSN 1530-4515
- Ravitch MM & Steichen FM. (1979). A stapling instrument for end to end inverting anastomosis in the gastrointestinal tract. *Ann Surg* 189: 791–797, ISSN 0003-4932
- Ritchey ML, Lally KP & Ostericher R. (1993). Comparison of different techniques of stapled bowel anastomoses in a canine model. *Arch Surg* 128: 1365–1367, ISSN 0272-5533
- Steichen FM & Ravitch MM. (1973). Mechanical sutures in surgery. *Br J Surg* 60: 191–197, ISSN 1365-2168
- Knight CD & Griffen FD. (1980). An improved technique for low anterior resection of the rectum using the EEA stapler. *Surgery* 88:710-714, ISSN 0039-6060
- Stericher R, Lally KP, Barrett DM & Ritchey ML. (1991). Anastomotic obstruction after stapled enteroanastomosis. *Surgery* 109:799-801, ISSN 0039-6060
- Graf W, Glimelius B, Bergstrom R & Pahlman L. (1991). Complications after double and single stapling in rectal surgery. *Eur J Surg* 157:543-547, ISSN 1102-4151
- Chiarugi M, Buccianti P, Sidoti F, Franceschi M, Goletti O & Cavina E. (1996). Single and double stapled anastomoses in rectal cancer surgery; a retrospective study on the safety of the technique and its indication. *Acta Chir Belg* 96:31-36, ISSN 0001-5458
- Vignali A, Fazio VW, Lavery IC, Milsom JW, Church JM, Hull TL, Strong SA & Oakley JR. (1997). Factors associated with the occurrence of leaks in stapled rectal anastomoses: a review of 1,014 patients. *J Am Coll Surg* 185:105-113, ISSN, ISSN 1072-7515
- Luna-Perez P & Rodriguez-Ramirez SE. (2002). Multivariate analysis of risk factors associated with dehiscence of colorectal anastomosis after anterior or lower anterior resection for sigmoid or rectal cancer. *Rev Invest Clin* 54:501-581, ISSN 0034-8376
- Sato H, Maeda K, Hanai T, Matsumoto M, Aoyama H & Matsuoka H. (2006). Modified double-stapling technique in low anterior resection for lower rectal carcinoma. *Surg Today* 36:30-36, ISSN 0941-1291
- Bardini R, Tosato SM & Termini B. (2003). Pursestring placement before transection of the rectum for facilitating the stapled low colorectal anastomosis. *Dis Colon Rectum* 46:1712-1714, ISSN
- Bluett MK, Healy DA, Kalemeris GC & O'Leary JP. (1986). Comparison of automatic staplers in small bowel anastomoses. *South Med J* 79:712-716, ISSN 0012-3706
- Arnold W & Shikora SA. (2005). A comparison of burst pressure between buttressed versus non-buttressed staple-lines in an animal model. *Obes Surg* 15:164-171, ISSN 0960-8923

- Hardacre JM, Mendoza-Sagaon M & Murata K. (2000). Use of a cauterizing laparoscopic linear stapler in intestinal anastomosis. *Surg Laparosc Endosc Percutan Tech* 10:128-132, ISSN
- Roumen RM, Rahusen FT, Wijnen MH & Croiset van Uchelen FA. (2000). "Dog ear" formation after double-stapled low anterior resection as a risk factor for anastomotic disruption. *Dis Colon Rectum* 43:522-525, ISSN 0960-8923
- Hendriks T & Mastboom WJ. (1990). Healing of experimental intestinal anastomoses. Parameters for repair. *Dis Colon Rectum* 33:891-901, ISSN 0960-8923
- Alper D, Ram E, Stein GY & Dreznik Z. (2005). Resting anal pressure following hemorrhoidectomy and lateral sphincterotomy. *Dis Colon Rectum* 48:2080-2084, ISSN 0960-8923
- Bittorf B, Stadelmaier U, Gohl J, Hohenberger W & Matzel KE. (2004). Functional outcome after intersphincteric resection of the rectum with coloanal anastomosis in low rectal cancer. *Eur J Surg Oncol* 30:260-265, ISSN 0748-7983
- Kawasaki K, Fujino Y, Kanemitsu K, Goto T, Kamigaki T, Kuroda D & Kuroda Y. (2007). Experimental evaluation of the mechanical strength of stapling techniques. *Surg Endosc*. 2007 Oct;21(10):1796-9. , ISSN 0930-2794
- Goto T, Kawasaki K, Fujino Y, Kanemitsu K, Kamigaki T, Kuroda D, Suzuki Y & Kuroda Y. (2007). Evaluation of the mechanical strength and patency of functional end-to-end anastomoses. *Surg Endosc*. 2007 Sep;21(9):1508-11. ISSN 0930-2794
- Kanemitsu K, Kawasaki K, Goto T, Fujino Y, Kamigaki T, Kuroda D & Kuroda Y. (2009). Experimental comparison of the stapled intestinal anastomotic techniques. *Surg Technol Int*. 2009;18:98-102. , ISSN 1615-7591

IntechOpen

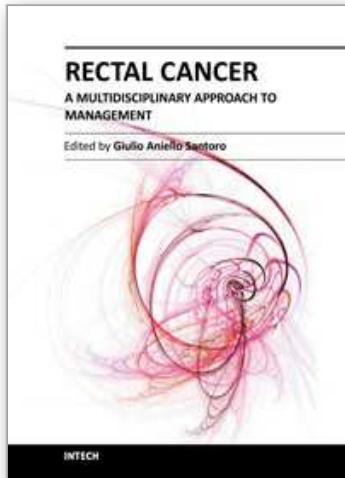

## **Rectal Cancer - A Multidisciplinary Approach to Management**

Edited by Dr. Giulio A. Santoro

ISBN 978-953-307-758-1

Hard cover, 410 pages

**Publisher** InTech

**Published online** 10, October, 2011

**Published in print edition** October, 2011

Dramatic improvements in medicine over the last few years have resulted in more reliable and accessible diagnostics and treatment of rectal cancer. Given the complex physiopathology of this tumor, the approach should not be limited to a single specialty but should involve a number of specialties (surgery, gastroenterology, radiology, biology, oncology, radiotherapy, nuclear medicine, physiotherapy) in an integrated fashion. The subtitle of this book "A Multidisciplinary Approach to Management" encompasses this concept. We have endeavored, with the help of an international group of contributors, to provide an up-to-date and authoritative account of the management of rectal tumor.

### **How to reference**

In order to correctly reference this scholarly work, feel free to copy and paste the following:

Kentaro Kawasaki, Kiyonori Kanemitsu, Tadahiro Goto, Yasuhiro Fujino and Yoshikazu Kuroda (2011). Experimental Evaluation of the Mechanical Strength of the Stapling Techniques: Experimental Study on Animal Model, Rectal Cancer - A Multidisciplinary Approach to Management, Dr. Giulio A. Santoro (Ed.), ISBN: 978-953-307-758-1, InTech, Available from: <http://www.intechopen.com/books/rectal-cancer-a-multidisciplinary-approach-to-management/experimental-evaluation-of-the-mechanical-strength-of-the-stapling-techniques-experimental-study-on->

**INTECH**  
open science | open minds

### **InTech Europe**

University Campus STeP Ri  
Slavka Krautzeka 83/A  
51000 Rijeka, Croatia  
Phone: +385 (51) 770 447  
Fax: +385 (51) 686 166  
[www.intechopen.com](http://www.intechopen.com)

### **InTech China**

Unit 405, Office Block, Hotel Equatorial Shanghai  
No.65, Yan An Road (West), Shanghai, 200040, China  
中国上海市延安西路65号上海国际贵都大饭店办公楼405单元  
Phone: +86-21-62489820  
Fax: +86-21-62489821

© 2011 The Author(s). Licensee IntechOpen. This is an open access article distributed under the terms of the [Creative Commons Attribution 3.0 License](#), which permits unrestricted use, distribution, and reproduction in any medium, provided the original work is properly cited.

IntechOpen

IntechOpen