

We are IntechOpen, the world's leading publisher of Open Access books Built by scientists, for scientists

5,200

Open access books available

129,000

International authors and editors

150M

Downloads

Our authors are among the

154

Countries delivered to

TOP 1%

most cited scientists

12.2%

Contributors from top 500 universities



WEB OF SCIENCE™

Selection of our books indexed in the Book Citation Index
in Web of Science™ Core Collection (BKCI)

Interested in publishing with us?
Contact book.department@intechopen.com

Numbers displayed above are based on latest data collected.

For more information visit www.intechopen.com



DNA Polymerase Processivity Factor of Human Cytomegalovirus May Be a Key Molecule for Molecular Coupling of Viral DNA Replication to Transcription

Hiroki Isomura

*Division of Virology, Aichi Cancer Center Research Institute
Japan*

1. Introduction

Human cytomegalovirus (HCMV) is a member of the betaherpesvirus family. Like all herpesviruses, HCMV is an enveloped, double-stranded DNA virus. The genome of HCMV is 240,000 bp in size with at least 150 known open reading frames (ORFs) (Dunn, Chou et al. 2003). A majority of the ORFs are nonessential for viral replication in cell culture. These nonessential ORFs likely encode proteins with redundant functions or proteins that may be required for replication in the human host. In addition, several ORFs are beneficial but not required for replication. However, approximately one-quarter, or 41 ORFs, are absolutely required for viral replication (Yu, Silva et al. 2003). The UL44 gene is essential.

During productive infection, HCMV genes are expressed in a temporal cascade, designated immediate early (IE), delayed early, and late. The major IE genes (MIE) UL123/122 (IE1/IE2) play a critical role in subsequent viral gene expression and the efficiency of viral replication (Meier and Stinski 1997; Meier and Pruessner 2000; Meier, Keller et al. 2002; Isomura and Stinski 2003; Isomura, Tsurumi et al. 2004; Isomura, Stinski et al. 2005). The IE72 protein, the predominant product of the IE1 transcript, is encoded by exons 2 and 3 spliced to exon 4. The IE86 protein, the predominant product of the IE2 transcript, is encoded by exons 2 and 3 spliced to exon 5. Translation of the IE1 and IE2 transcripts begins in exon 2. The IE72 protein is not essential for viral replication at high MOI, but the IE86 protein is essential (Marchini, Liu et al. 2001). The early viral genes encode proteins necessary for viral DNA replication (Pari and Anders 1993). Following viral DNA replication, delayed early and late viral genes are expressed which encode structural proteins for virion production.

The UL 44 protein (pUL44), which binds double-stranded DNA, is an essential accessory protein for viral DNA replication and interacts specifically with the viral DNA polymerase encoded by UL54 (Pari, Kacica et al. 1993; Ripalti, Boccuni et al. 1995). pUL44 increases processivity of the polymerase along the viral DNA template (Ertl and Powell 1992; Weiland, Oien et al. 1994; Zuccola, Filman et al. 2000). The accumulation of the pUL44 is to strikingly high levels at late times after infection (Stinski 1978; Geballe, Leach et al. 1986). Its late kinetics of transcription and the high level of expression suggest an additional important role for viral replication. pUL44 is phosphorylated by the viral UL97 protein

kinase (pUL97) in infected cells (Krosky, Baek et al. 2003). Phosphorylation by pUL97 is not required for pUL44 to interact with the catalytic subunit of the viral DNA polymerase (Ertl and Powell 1992; Weiland, Oien et al. 1994).

The HCMV UL44 transcription unit initiates at three distinct sites, which are separated by approximately 50 nucleotides and are differentially regulated during productive infection. Two of these start sites, the distal and the proximal, are active at early times, whereas the middle start site is inactive until late times (Leach and Mocarski 1989). Expression from the late start site is dependent upon viral DNA replication.

We investigated whether the late start site is necessary for efficient viral DNA replication in human fibroblast cells.

2. Distinct regulation of HCMV DNA polymerase processivity factor

Transcriptional regulation of UL44 gene expression occurs at two levels. The two transcription start sites that are activated early in infection presumably respond to IE proteins. Each contains a conventional TATA element, which is the only region of significant homology between start sites 1 and 3. Late in infection, sequences that are dependent on DNA replication result in transcriptional activation at start site 2 (Leach and Mocarski 1989). This is referred to as a late viral promoter.

2.1.1 Effect of the TATA elements on UL44 transcription

To determine the role of the late UL44 promoter, we constructed recombinant viruses with the distal-early or the middle-late UL44 TATA elements mutated (dITATA1, or dITATA2, respectively) (Fig. 1).

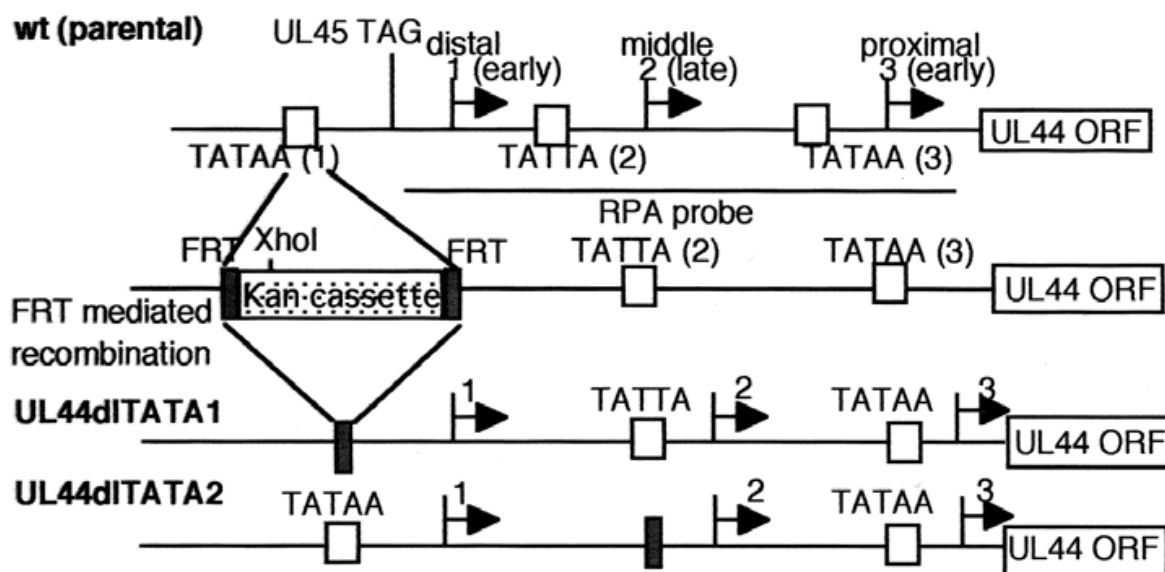

Fig. 1. Structure of recombinant HCMV BAC DNAs. Recombinant viruses with TATA element mutations. UL44 transcription initiates at three distinct sites (labeled as start site 1, 2, and 3), which are separated by approximately 50 nucleotides. Two of these start sites, the distal and proximal, were active at early times after infection, whereas the middle start site was inactive until late times. The distal or middle TATA element was replaced by KanR with FRT sequence flanking. KanR was excised by FLP-mediated recombination.

To detect all the transcripts derived from the different start sites, RNase protection assay was employed. Three major transcripts initiating at the spatially distinct start sites were detected 2 and 3 days after infection with wild type virus (wt) (Fig. 2). Consistent with a previous report (Leach and Mocarski 1989), the middle transcript was not detected with wt and dITATA1 in infected cells maintained in the presence of phosphonoacetic acid (PAA), which is an inhibitor of HCMV DNA synthesis for 48 h (Fig. 2, lanes: 12 and 13), indicating that the TATA2 element was activated upon viral DNA replication. Substitution of the TATA2 element caused loss of the late transcript initiating at start site 2. (Fig. 2, lanes: 6 to 11). The levels of the middle and the proximal transcripts derived from dITATA1 were slightly lower than those of wt at 2 d.p.i. (Fig. 2, lanes: 6 and 7). Since levels of the proximal transcripts were similar between wt and dITATA1 in the presence of PAA for 48 h. (Fig. 2, lanes: 12 and 13), substitution of the TATA1 element affects the transcription initiating at

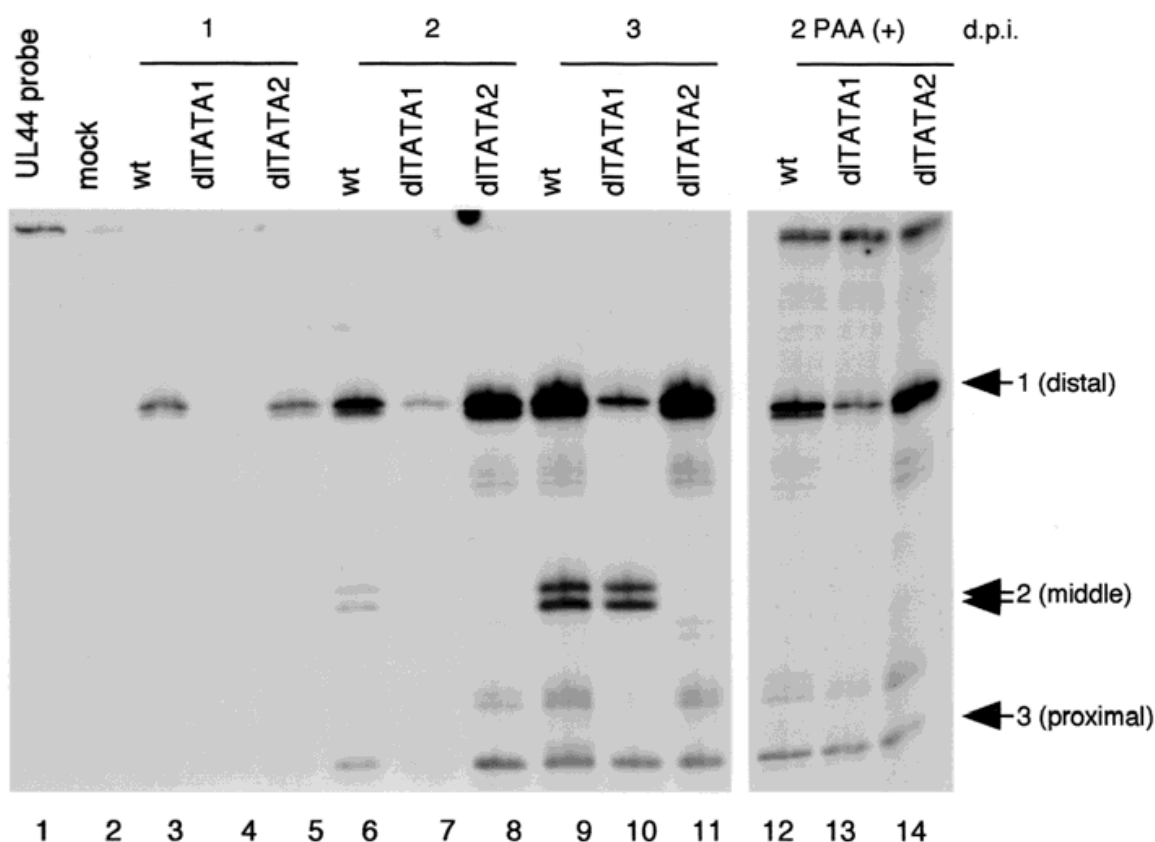

Fig. 2. Effect of substitution for each TATA element on the UL44 transcription in cells infected with wt and recombinant viruses. Cytoplasmic RNAs were harvested at 1, 2, and 3 days after infection with an MOI of approximately 1. Twenty micrograms of RNA was hybridized to ³²P-labeled antisense UL44 promoter probe at 37 °C overnight before digestion with RNase T1. Antisense UL44 probe contains sequence upstream of the transcription start site of all the UL44 transcripts. The protected RNA fragments were subjected to electrophoresis in denaturing 6% polyacrylamide gels. Lanes: 1, Probe lacking RNase T1; 2, mock; 3, 6, 9, and 12 wt; 4, 7, 10, and 13 dITATA1; 5, 8, 11, and 14 dITATA2; 3 to 5, 1 d.p.i.; 6 to 8 2 d.p.i.; 9 to 11, and 12 to 14, 3 d.p.i.; 12 to 14 in the presence of phosphonoacetic acid (PAA). Arrow 1, 2, or 3 indicates the transcript initiating at start site 1, 2, or 3, respectively.

start site 2 and 3 in a viral DNA replication dependent manner. Since pUL44 is an essential viral protein that acts as a processivity factor for the catalytic subunit of the viral DNA polymerase (pUL54) (Ertl and Powell 1992; Pari, Kacica et al. 1993; Weiland, Oien et al. 1994; Ripalti, Boccuni et al. 1995; Zuccola, Filman et al. 2000), loss of transcription start site 1 was responsible for the lower level of viral DNA replication of recombinant virus dITATA1. Taken together, mutation of the distal or middle TATA element reduced the transcription from the corresponding start sites.

2.1.2 The middle element had no effect on viral DNA synthesis

We compared viral DNA replication of the recombinant viruses with wt at high or low MOI. While the relative input of viral genomes for an MOI equivalent to approximately 1 differed between 0.001 and 0.0007 for wt, dITATA1, and dITATA2 (Fig. 3a), viral DNA of dITATA1 was 5 to 10 times lower compared to wt after infection at an MOI of approximately 1 or 0.01 (Fig. 3a and b, respectively) and dITATA2 was similar to wt in relative amount (Fig. 3a and b, respectively). These results indicate that the reduction of late gene expression in the cells infected with dITATA2 was not due to reduced DNA template for transcription.

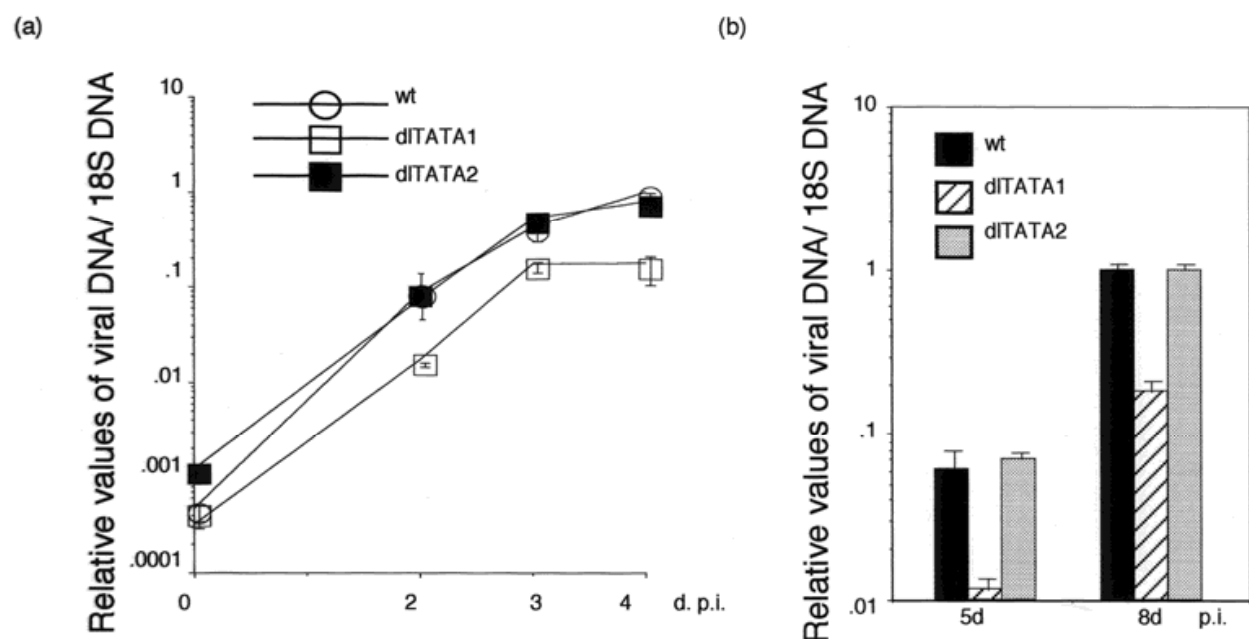

Fig. 3. Analysis of viral DNA replication after high or low MOI infection with wt and recombinant viruses. HFF cells were infected with wt or recombinant viruses at an MOI of approximately 1 or 0.01 and analyzed for viral DNA replication. Viral DNA was quantified by real-time PCR with gB primers and probe as described in the Materials and Methods. Real-time PCR with 18S primers and probe were also performed to serve as an internal control. Data are averages of three independent experiments. (a) HFF cells were infected with wt, dITATA1, or dITATA2 at an MOI of approximately 1 and harvested at 2, 3, and 4 d.p.i. Each value, relative to the level of the wt DNA at 4 d.p.i., was calculated and plotted. (b) HFF cells were infected with wt, dITATA1, or dITATA2 at an MOI of approximately 0.01 and harvested at 5, and 8 d.p.i. Each value, relative to the level of the wt DNA at 8 d.p.i., was calculated and plotted.

2.1.3 The distal and middle TATA element had an impact on the viral delayed early and late gene transcription

To compare the overall viral delayed early and late transcription of the recombinant viruses with wt, cells were assayed for immediate early, early, delayed early and late gene transcripts by Northern blotting at 1, 2, and 3 d.p.i. RNA from infected cells maintained in the presence of PAA for 2 d was also assayed. RNA analysis after PAA treatment for 48 h did not show a significant difference of IE1 RNAs between wt, dITATA1, and dITATA2 (Fig. 4a, lanes: 7 to 9, and Fig. 4e). In contrast, the level of IE RNAs from dITATA1 was approximately two-fold lower than that of wt and dITATA2 2 and 3 d. p.i (Fig. 4a, lanes: 5 and 6, and 10 and 11, and Fig. 4e). This might suggest that viral DNA replication modulated the IE transcription from the MIE promoter. In the absence of PAA, the amount of UL44 RNA from dITATA1 was more than two-fold lower than that from wt at 1, 2, and 3 d.p.i. (Fig. 4b, lanes: 1 and 2, 4 and 5, and 10 and 11, and Fig. 5e). There was no significant difference in the amount of UL44 RNA between wt and dITATA2 at 1 and 2 d. p.i. (Fig. 4, lanes: 1 and 3, and 4 and 6, and Fig. 5e). In contrast, the level of UL44 transcript from dITATA2 was approximately 2-fold lower than that of wt at 3 d p.i. (Fig. 4b, lanes: 10 and 12, and Fig. 5e). The reduction of the UL44 transcript in the cells infected with dITATA1 or dITATA2 correlates with the loss of the corresponding early or late transcript initiating at start site 1 or 2, respectively (see figure 2).

The UL99 ORF, which encodes a tegument protein of HCMV, is located in a complex region of HCMV with a series of 3'-coterminal transcripts (Wing and Huang 1995). All the transcripts utilize a common polyadenylation site downstream of ORF UL99 (Wing and Huang 1995). Thus, real-time PCR analysis using the UL99 primers and probe detects the total amount of the UL92 to 99 transcripts. The pp28 tegument protein is translated from two mRNAs of 1.6 and 1.3 kb. The 1.3 kb mRNA is of relatively low abundance (Adam, Jervey et al. 1995). Northern blot analysis using the UL99 probe showed that in the presence of PAA, the 1.6 kb mRNA from the UL99 promoter was not detectable, thus UL99 is a true late gene (Fig. 4c, lanes: 7 to 9) as reported previously (Adam, Jervey et al. 1995). Consistent with the previous report (Wing and Huang 1995), analysis of PAA-treated RNA also showed that mRNAs initiating upstream of each of the potential ORFs in this region contained late transcripts (Fig. 4c lanes: 7 to 9). We did not detect differences in the level of steady-state mRNAs between wt and dITATA2 at 1 and 2 d.p.i. but we did detect it at 3 d.p.i. (Fig. 4c, lanes: 1 and 3, 4 and 6, and 10 and 12). From a quantitative analysis using real-time RT-PCR analysis, the amount of the UL92 to 99 transcripts for dITATA1 and dITATA2 was more than two-fold lower at 2 and 3 d.p.i, respectively (Fig. 4e). These results indicate that the early or late transcripts initiating at start site 1 or 2 of the UL44 gene facilitated delayed early and late transcription.

To determine whether the product from the UL44 late transcript initiating at start site 2 affected other late gene expression, Northern blot analysis using the UL75, which encodes a glycoprotein of HCMV, probe was also performed. Three mRNAs were detected (Fig. 4d). Two transcripts, 4.5 and 5.5 kbp, corresponding to the UL76, and UL77 and UL78 genes, respectively, which utilize different transcription start sites as reported previously (Wang, Duh et al. 2004). An analysis of the transcripts of the recombinant virus with an UL76 ORF deletion determined the transcript from the UL76 promoter in the three mRNAs. The direction of transcription of the UL75 ORF is opposite to that the UL76, 77, or 78 ORFs. Thus, real-time RT-PCR analysis using the UL75 primers and probes detects only the UL75 transcript. The initiation site of UL75 transcript was determined by primer extension as

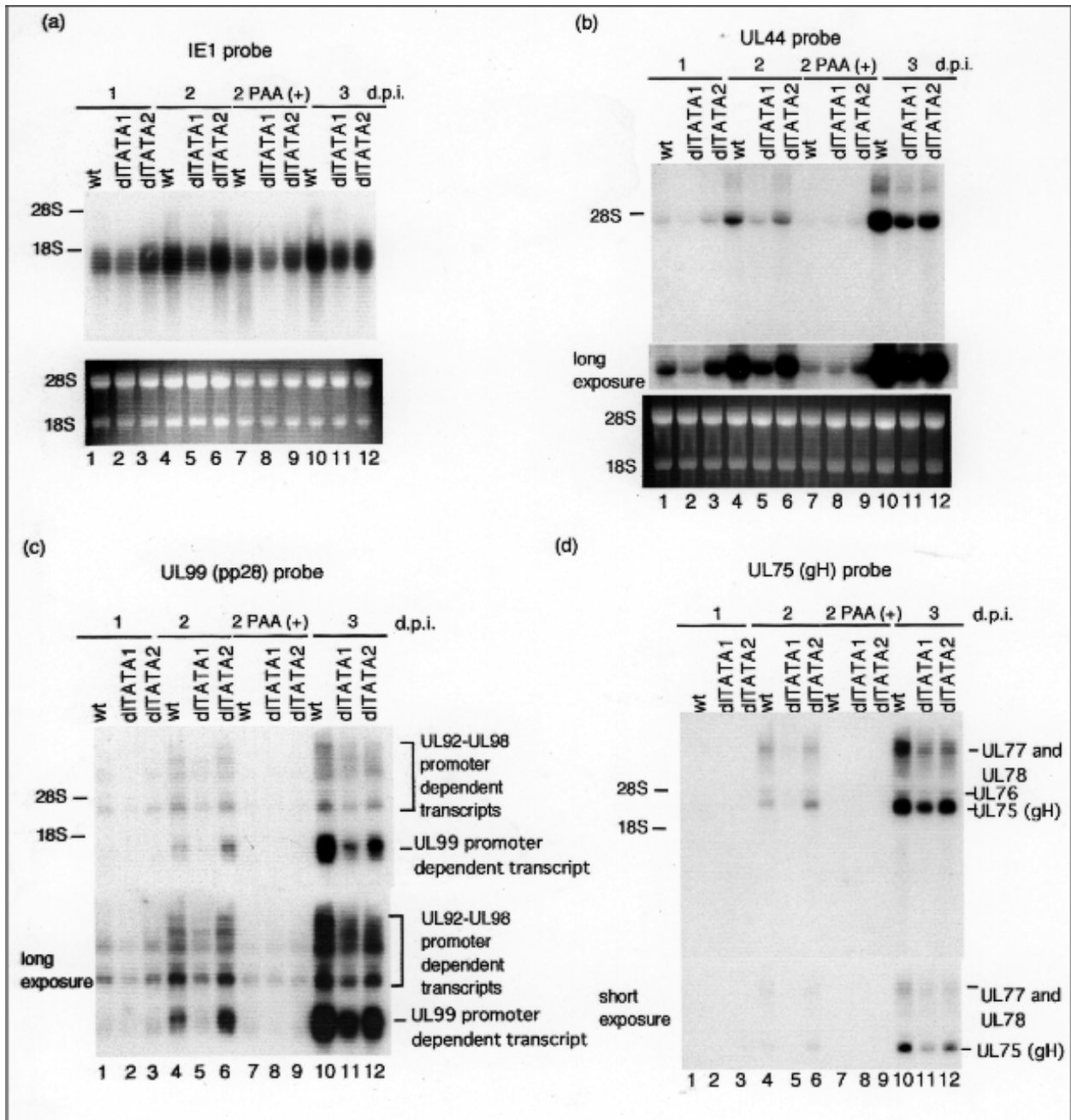

(e)

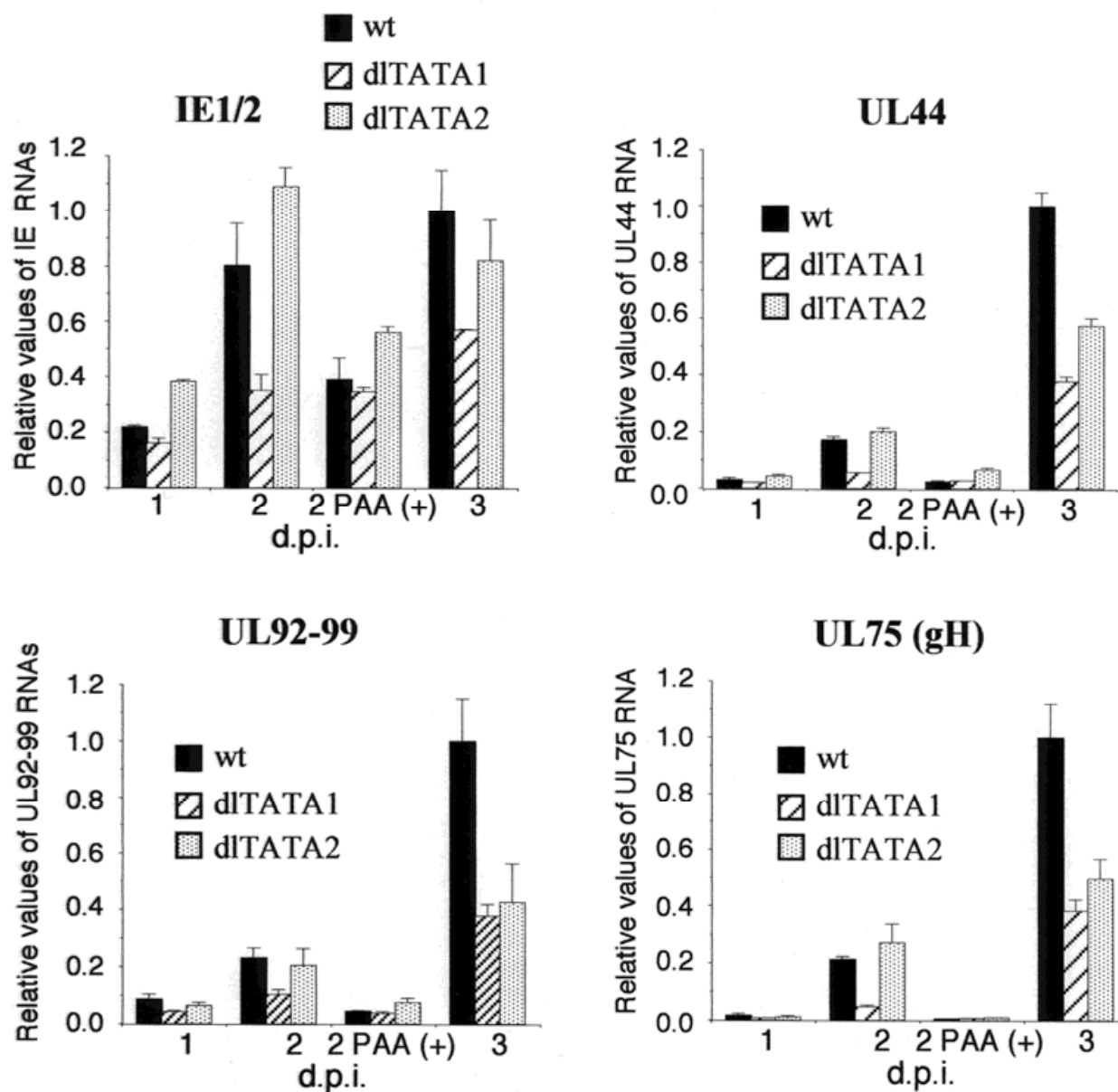

Fig. 4. Analysis of UL44 and the subsequent gene transcription after infection with wt and recombinant viruses. HFF cells were infected with an MOI (multiplicity of infection) of approximately 1 and cytoplasmic RNA was harvested at 1, 2, and 3 d.p.i. as described in Materials and Methods. (a-d) Northern blotting for IE1, UL44, UL99 (pp28), or UL75 (gH). 28S and 18S ribosomal RNA served as controls for an equal amount of RNA loading. Lanes: 1, 4, 7, and 10, wt; 2, 5, 8, and 11, dITATA1; 3, 6, 9, and 12, dITATA2; 1 to 3, 1 d.p.i.; 4 to 6, 2 d.p.i.; 7 to 9, 2 d.p.i. in the presence of PAA; 10 to 12, 3 d.p.i. (a) Analysis with IE1 probe; (b) Analysis with UL44 probe; (c) Analysis with UL99 (pp28) probe; (d) Analysis with UL75 (gH) probe. (e) Real-time RT-PCR for analysis for IE1/2, UL44, UL92-99 and UL75 (gH) gene transcripts.

described previously (McWatters, Stenberg et al. 2002). RNA analysis from PAA-treated cells for 48 h suggested that the UL75 is a true late viral gene (Fig. 4d, lanes 7 to 9 and long exposure: data not shown). Since a small amount of the transcripts from the UL76, UL77 and UL78 promoters were detected in PAA-treated cells after long exposure (data not shown), UL76, 77, and 78 were delayed early viral genes. Similar to the result using the probe for UL99, the level of steady-state mRNAs from the UL76, and the UL77 and UL78 promoters in the cells infected with dITATA2 was lower compared to wt at 3 d.p.i. (Fig. 4d, lanes 10 and 12). Likewise, the transcript from the UL75 promoter was also approximately 2-fold lower for dITATA2 at 3 d. p.i. (Fig. 4d, lanes: 10 and 12, and Fig. 4e). The steady-state mRNAs from UL75, UL76, and UL77 and UL78 promoters in the cells infected with dITATA1 were lower at 2, and 3 d.p.i. (Fig. 4d, lanes: 5 and 6, and 10 and 11, and Fig. 4e). Since DNA replication of recombinant virus dITATA2 was similar to wt, reduction in viral gene expression was not due to reduced DNA template for transcription. Taken together, the UL44 gene product from the late transcript initiating at start sites 2 has an impact on viral delayed early and late gene transcription independently of viral DNA replication.

pUL44 is detected at sites of HCMV DNA replication centers in the nucleus (Penfold and Mocarski 1997; Park, Kim et al. 2006). Viral replication centers also serve as foci for viral gene expression, presumably in part by concentrating templates for transcription with the proteins that carry out or regulate this process. The herpes simplex virus (HSV) single-stranded DNA-binding protein, ICP8 is also located at viral DNA replication centers in the nucleus and stimulates multiple late viral gene promoters (Gao and Knipe 1991). A recent report shows that ICP8 co-precipitates with chromatin remodeling factors (Taylor and Knipe 2004). Whether or not pUL44 is also associated with ATP-dependent nucleosome remodeling proteins on the HCMV genome is not known, but it might be possible that pUL44 recruits activating chromatin remodeling factors to late viral promoters at late times after infection.

2.1.4 The distal and middle TATA element reduced accumulation of late viral protein

We determined whether the reduction of these viral gene transcriptions affected expression of the viral late proteins. Compared to wt, the levels of the late viral protein pp28 (pUL99) were 16.7 and 7.4 -fold lower for dITATA1 and dITATA2, respectively (Fig. 5, lanes: 8 and 9).

2.1.5 Growth kinetics of the recombinant viruses

Since accumulation of late viral protein for the recombinant viruses was reduced, we compared the growth of the recombinant viruses with wt at low or high MOI. HFF cells were infected with wt or recombinant virus at an MOI of approximately 0.01 or 1. Virus from infected cultures at 1,5, 8, 11 and 14 d.p.i. or 1, 4, 5, 7, and 9 d.p.i., respectively, were assayed as described in the Materials and Methods. Viral growth of dITATA1 or dITATA2 was slightly delayed compared to the wt at low and high MOI infection (Fig. 6a and b). We detected approximately a 5 to 10-fold difference in viral replication at low MOI infection between wt and dITATA2 at 5 and 8 d.p.i. (Fig. 6a), while DNA replication of dITATA2 was similar at the same time (see figure 3a and b). Likewise, at high MOI infection, the viral titer of dITATA2 was approximately 10-fold lower than that of wt at 4 and 5 d.p.i.. (Fig. 6b), while viral DNA replication of dITATA2 was similar to wt (see figure 3a and b). Therefore, insufficient expression of the late gene product of UL44 was linked to delayed viral growth.

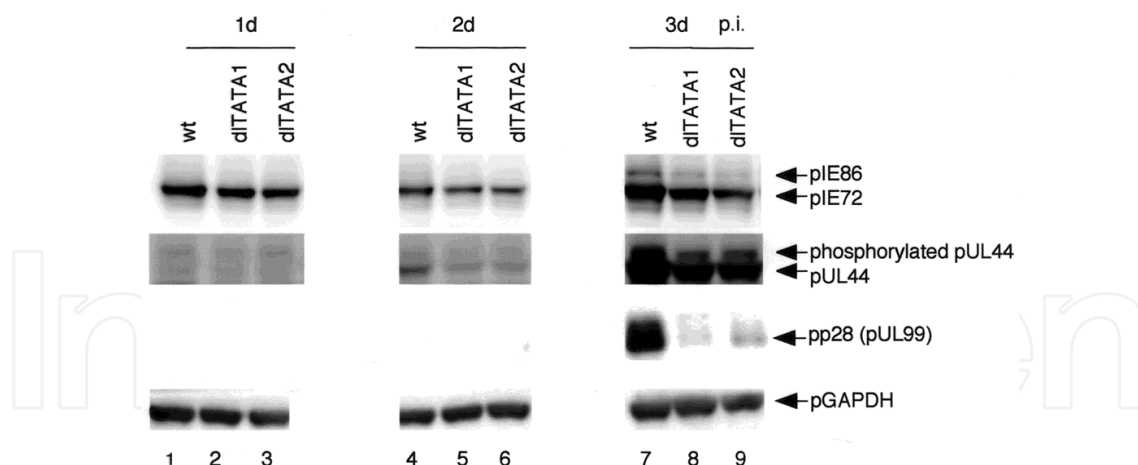

Fig. 5. Analysis of viral protein expression after infection with wt and recombinant viruses. HFF cells were infected with the wt and the recombinant viruses at an MOI of 1 and analyzed for viral proteins. Immediate early pIE72 (UL123), pIE86 (UL122), early ppUL44, and late pp28 proteins were analyzed 1, 2, and 3 d p.i. Anti-pGAPDH (p36) antibody was used to show equal protein loading. Lanes: 1, 4, and 7, wt; Lanes: 2, 5, and 8, dITATA1; 3, 6, and 9, dITATA2. Lanes 1-3, 1 d p.i.; 4-6, 2 d p.i.; 7-6, 3 d p.i.

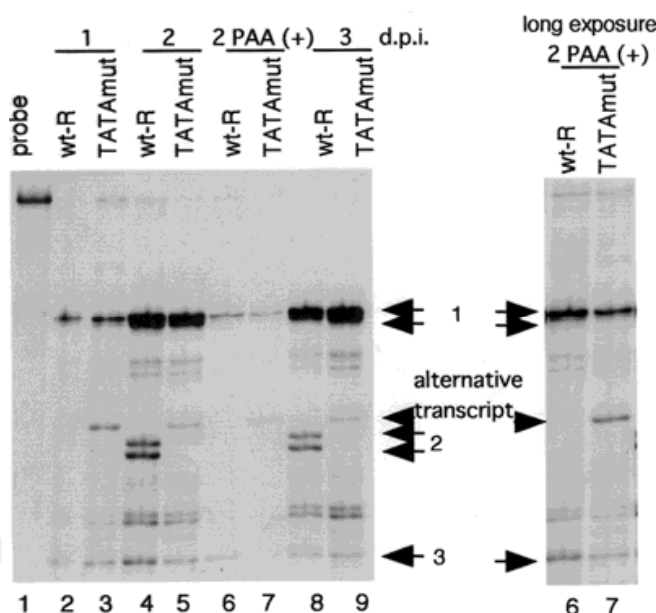

Fig. 6. Analysis of viral DNA replication after high or low MOI infection with wt and recombinant viruses. HFF cells were infected with wt or recombinant viruses at an MOI of approximately 1 or 0.01 and analyzed for viral DNA replication. Viral DNA was quantified by real-time PCR with gB primers and probe as described in the Materials and Methods. Real-time PCR with 18S primers and probe were also performed to serve as an internal control. Data are averages of three independent experiments. (a) HFF cells were infected with wt, dITATA1, or dITATA2 at an MOI of approximately 1 and harvested at 2, 3, and 4 d.p.i. Each value, relative to the level of the wt DNA at 4 d.p.i., was calculated and plotted. (b) HFF cells were infected with wt, dITATA1, or dITATA2 at an MOI of approximately 0.01 and harvested at 5, and 8 d.p.i. Each value, relative to the level of the wt DNA at 8 d.p.i., was calculated and plotted.

2.2.1 Effect of the TATA sequence in the UL44 middle promoter on the kinetics of transcription and the start site selection

What determines the kinetics of the UL44 late transcript start site is unclear. An important parameter governing transcription initiation is the relative concentration of the viral DNA template and the promoter sequence. As discussed previously (Leach and Mocarski 1989), The UL44 early promoters have a canonical TATA sequence of "TATAA". In contrast, the viral late or middle TATA element is a noncanonical sequence of "TATTATTA" (Fig. 1). To determine the significance of the noncanonical TATA sequence on UL44 late gene expression from the middle promoter, we constructed recombinant viruses with the UL44 middle TATA sequence of "TATTATTA" mutated to "TATataaA", to contain a canonical TATA sequence, "TATAA" and the revertant (wt-R) (Fig. 1). The lower case letters indicate the mutated bases. The proximal and distal transcripts were similar between wt-R and TATAmut at 1, 2, and 3 d.p.i. (Fig. 7). In contrast, an alternative transcript initiating upstream of start site 2 was detected with TATAmut in infected cells 1, 2, and 3 d.p.i. (Fig. 7, lanes 3, 5, and 9). The alternative transcript was not detected with wt-R in the presence of PAA at 48 h but it was detected with TATAmut (Fig. 7, compare lanes 6 and 7). The transcript initiating at start site 2 was also detected with TATAmut, but it was at very low levels at 2 and 3 d p.i. (Fig. 7, lanes 5 and 9). The sequence of the UL44 middle TATA nucleotides affects the kinetics and the TSS selection of the UL44 late transcript.

2.2.2 The noncanonical TATA sequence in the UL44 middle promoter is required for the accumulation of late transcripts

To confirm that the noncanonical TATA sequence is required for the accumulation of late transcripts, we made adenine and thymidine substitutions to generate recombinant viruses TATAmut2 and TATAmut3 (Fig. 8a). As shown in Fig. 3b, when the TATA sequence is mutated to contain a canonical TATA sequence "TATAA", the accumulation of late transcripts was decreased at 2 and 3 d p.i. (compare lanes 9 with 1 to 8). An alternative transcript was detected with TATAmut3 as well as the middle transcripts from the start site 2 at 2 and 3 d p.i. (Fig. 8b, lanes 5 and 8). These transcripts were not detected in the presence of PAA at 2 d p.i. (Fig. 8b, lanes 4 and 6). Since TATAmut contains a repeat of thymine and adenine nucleotides in front of TAA in the UL44 middle promoter (see figure 1), the number of the TA repeats in front of TAA nucleotides may determine the strength of the UL44 middle promoter with TATAmut3. While the level of the distal transcript was similar between TATAmut2 and TATAmut3, the transcripts derived from the UL44 middle promoter with mut2 was lower than those with mut3 at 2 and 3 d p.i. (Fig. 8b: lanes 3, 5, 7, and 8). The noncanonical TATA sequence in the UL44 middle promoter influences the accumulation of late transcripts.

The transcriptional strategies of DNA viruses exhibit a number of common features. Prior to initiation of viral DNA synthesis, during IE and early phases, infected cells are devoted to the production of viral proteins necessary for viral DNA synthesis, efficient expression of viral genes, or the other regulatory functions. Transcription of the late genes requires viral DNA synthesis. However, the molecular coupling of replication to transcription of late genes remains unclear. A part of the newly replicated DNA could serve as templates for transcription. Therefore, one hypothesis is that the increased concentration of transcriptional templates is necessary for initiation of the late UL44 transcription. The relative weak binding

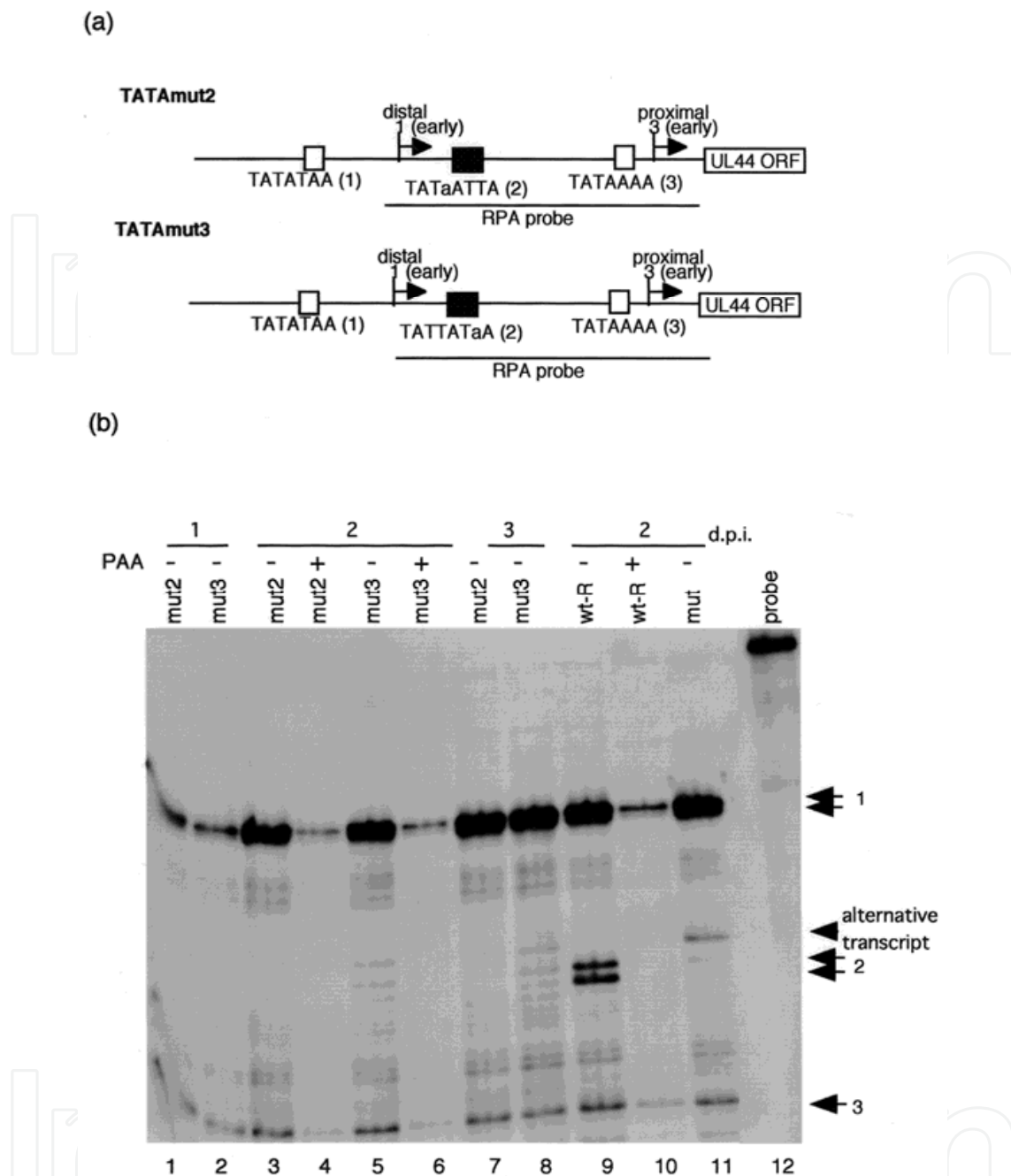

Fig. 7. Effect of the UL44 middle TATA nucleotides on the UL44 transcription in cells infected with wt-R and the recombinant virus. Cytoplasmic RNAs were harvested at 1, 2, and 3 days after infection with an MOI of approximately 3. Twenty micrograms of RNA was hybridized to ³²P-labeled antisense UL44 RNA probe at 37 °C overnight before digestion with RNase T1. Antisense UL44 RNA probe contains sequence upstream of the transcription start site of all the UL44 transcripts. The protected RNA fragments were subjected to electrophoresis in denaturing 6% polyacrylamide gels. Lanes: 1, lacking RNase T1; 2, 4, 6, and 8, wt-R; 3, 5, 7, and 9, TATAmut; 2 and 3, 1 d.p.i.; 4 to 7, 2 d.p.i.; 8 and 9, 3 d.p.i.; 6 and 7, in the presence of phosphonoacetic acid (PAA). Arrow1, 2, or 3 indicates the transcript initiating at start site 1, 2, or 3, respectively. Allowhead indicates the alternative transcript due to the substitution for the UL44 middle TATA nucleotides.

affinity of TBP to the noncanonical TATA sequence at the middle promoter may explain a lack of transcription at early times after infection. However, the weak binding affinity of TBP to the middle promoter is not the only reason for the lack of early transcription because late transcripts were not detected with recombinant viruses TATAmut2 or TATAmut3, while an alternative transcript was significantly detected with TATAmut3. Late specific transcription from a noncanonical TATA sequence may be simply a concentration effect after viral DNA synthesis or reflect the presence of a viral transcription factor that specifically activates a late promoter.

The main function of TATA box is to anchor the transcription preinitiation complex guiding RNA polymerase upstream of the transcription start site (TSS). Therefore, the spacing between TATA box and TSS is functionally important for efficient transcription (Ponjavic, Lenhard et al. 2006), but the underlying mechanisms that determine the start site selection are not understood. As previously shown (Carninci, Sandelin et al. 2006), the preferred canonical sequence for the initiation site is a pyrimidine-purine (PyPu) dinucleotide situated at position -1, +1 relative to TSS. When the UL44 middle TATA element was replaced by a canonical sequence, the distance between the TATA box and TSS was shortened from 32 or 37 to 22 nucleotides. Further studies are required to determine the role of a noncanonical TATA sequence at the middle promoter of the UL44 transcription unit on the viral late gene transcription.

3. Conclusion

While pUL44 accumulates to strikingly high levels at late times after HCMV infection, viral DNA polymerase does not accumulate. The late accumulation of pUL44 depends on the late UL44 promoter, which is required for efficient HCMV delayed early and late gene expression.

4. Materials and methods

Cells and virus titration. Primary human foreskin fibroblast (HFF) cells were maintained in Eagle's minimal essential medium supplemented with 10% fetal calf serum (Sigma, St. Louis, Mo.), penicillin (100 U/ml), and streptomycin (100 µg/ml) at 37°C in 5% CO₂ as described previously (Stinski 1978). The virus titers of wild type (wt) HCMV Towne and recombinant viruses were determined by standard plaque assays on HFF cells as described previously (Meier and Stinski 1997). Viral DNA input was determined by infecting HFF cells in 35 or 60 mm plates in triplicate, and harvesting the cells at 4 h post infection (p.i.) in PCR lysis buffer (10mM Tris-HCl, pH 8.0, 1mM EDTA, 0.001% TritonX-100, and 0.001% SDS) containing 50 µg/ml proteinase K. After 55°C for 100 min, the proteinase K was inactivated at 95°C for 10 min. The relative amount of input viral DNA was estimated by real-time PCR using HCMV gB primers and probes as described previously (Isomura, Tsurumi et al. 2004). For analysis of virus growth kinetics, cells were infected at a multiplicity of 0.01 or 1 plaque-forming unit (PFU)/cell with the wt and the recombinant viruses. At various times after infection, whole cells and supernatant including free virus was collected from infected cultures and three freeze-thaw cycles were performed before titration. Virus titers were determined by the 50% tissue culture infectious dose (TCID₅₀) assay on HFF cells as described previously (Nevels, Brune et al. 2004; Nevels, Paulus et al. 2004; Wang and Shenk

2005) except GFP foci rather than CPE were counted. We used Reed-Muench method to calculate TCID₅₀. Wt and the recombinant viruses contain the GFP gene substituted for the dispensable, 10-kb US1-US12 region (US, unique short).

RNase protection (RPA) assay. For construction of the antisense UL44 probe, DNA fragment including 5' upstream of the transcription start site of all the UL44 transcript was amplified by PCR using primer pairs of UL44 F2 RPA primer (5'-CCGCTGGCTCGGCGCGGCTG-3') and UL44 inner primer as described above, and cloned into TA cloning vector pCRII (Invitrogen). The resulting clone, pUL44 pro-5 was linearized with EcoRV and used as a template for SP6 RNA polymerase. Synthesis by SP6 RNA polymerase on linear pUL44 pro-5 DNA produced a ³²P-labeled antisense RNA probe in agreement with the predicted size. Cytoplasmic RNAs from mock-infected or HCMV-infected HFFs were isolated at the indicated times after infection as described previously (Hermiston, Malone et al. 1987; Chang, Malone et al. 1989). DNA replication was inhibited with 200 µg/ml phosphonoacetic acid (PAA) (Sigma, St. Louis, MO.) added to the medium at the time of infection and maintained throughout infection. Twenty micrograms of RNA was hybridized to ³²P-labeled antisense UL44 promoter probe at 37 °C overnight before digestion with RNase T1 (100U) as described previously (Lashmit, Stinski et al. 1998; Isomura and Stinski 2003). The protected RNA fragments were subjected to electrophoresis in denaturing 6% polyacrylamide gels followed by autoradiography on Hyperfilm MP (Amersham).

Northern blot analysis. Twenty micrograms of cytoplasmic RNA was subjected to electrophoresis in a 1% agarose gel containing 2.2 M formaldehyde and transferred to maximum strength Hybond N+ (Amersham). Northern blot analysis with IE1 probe was performed as described previously (14, 15). UL44, UL99 or UL75 DNA was amplified by PCR using the primer pairs of UL44 ORFF (5'-TGCAGGACATCTCGGACCTGTCCGG-3') and UL44ORFR (5'-CCAGACGCTGCTCAATTGCGCCG-3'), UL99F (5'-TGTTGAGTTCGGTACCACGCCCGG-3') and UL99R (5'-CGTCTAGGTCGTCCGCTCTCCTGC-3'), or UL75F (5'-CTGCGAAAAAGATCGGTAGCTGGCC-3') and UL75R (5'-CGCTGGACCCTCACGCATTTACCTA-3'), respectively. A radioactive probe was generated by labeling with ³²P-dCTP as described above.

Real-time RT-PCR analysis. Reverse transcriptase (RT) (Roche Applied Science, Penzberg, Germany) was used according to the manufacturer's directions to generate first strand cDNA from 2 µg of RNA and 250 ng of oligo-dT primer (Roche) in a final volume of 40 µl. Samples were heat-inactivated at 80°C for 5 min. Amplifications were performed in a final volume of 10 µl containing PLATINUM Quantitative PCR SUPERMIX-UDG cocktail (Invitrogen). Each reaction mixture contained 1 µg of the first-strand cDNA, 5 mM MgCl₂, and 500 nM each primer, 250 nM each probe. MIE primers and MIE reporter probe were designed as described previously (Meier, Keller et al. 2002). HCMV UL44, UL92-99, and UL75 forward and reverse primers and reporter probe were designed using Primer Express[®] (Applied Biosystems) as follows. UL44F: 5'-TTTTCTCACCGAGGAACCTTTC-3'; UL44R: 5'-CCGCTGTTCCCGACGTAAT-3'; UL44 probe: 5'-6-FAM-AGCGTGGCGATCCCTTCGACAA-tetramethyl rhodamine (TAMRA)-3'; UL99-255F: 5'-CCACGACGGCTCCAAGAA-3'; UL99-319R: 5'-TCGGTTTCGGAGCCTTGTC-3'; UL99-275Tprobe: 5'-6-FAM-ACGCGGTGCGCTCGACGTT-TAMRA-3'; UL75-272F:

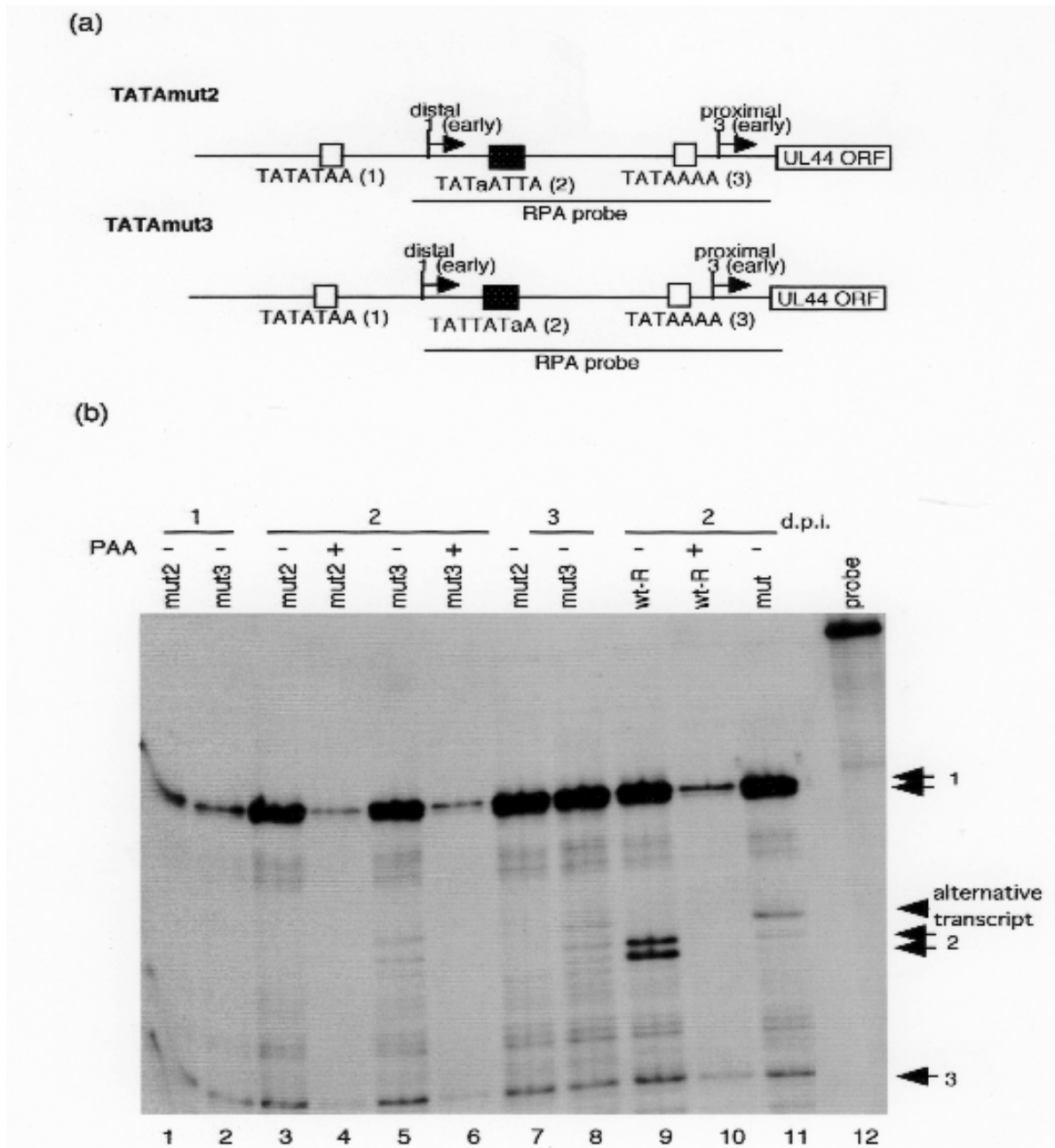

Fig. 8. Effect of a canonical TATA sequence in the UL44 middle promoter on the accumulation of late transcripts. (a) Schematic representation of the recombinant viruses substituted with a canonical TATA sequence. (b) RNAs were harvested at 1, 2, and 3 days after infection with an MOI of approximately 3. RNase protection assay was performed with ^{32}P -labeled antisense UL44 RNA probe at 37 °C overnight before digestion with RNase T1. The protected RNA fragments were subjected to electrophoresis in denaturing 6% polyacrylamide gels. Lanes: 1, 3, 4, and 7 mut2; 2, 5, 6, and 8 mut3; 9 and 10, wt-R; 11, mut; 12, lacking RNase T1; 1 and 2, 1 d.p.i.; 3 to 6 and 9 to 11, 2 d.p.i.; 7, and 8, 3 d.p.i.; 4, 6, and 10, in the presence of phosphonoacetic acid (PAA); Arrow 1, 2, or 3 indicates the transcript initiating at start site 1, 2, or 3, respectively. Allowhead indicates the alternative transcript due to the substitution for the UL44 middle TATA nucleotides.

5'-TCCATATGCCTCGATGTCTTTT-3'; UL75-339R: 5'-
GGTCAGATCTACCTGGTTCAGAAAC-3'; UL75-296Tprobe: 5'-6-FAM-
TTGGGCAACCACCGCACTGAGG-TAMRA-3' (Nihon Gene Research Laboratories Inc.,
Sendai, Japan). Thermal cycling conditions were an initial 50°C for 2 min and 95°C for 2
min, followed by 40 cycles of 95°C for 15 sec and 60°C for 1 min. Quantitation of relative
RNA was accomplished according to a standard curve analysis as described previously
(Meier, Keller et al. 2002). Real-time PCR with G6PD primers and probe as described
previously (White, Clark et al. 2004) were also performed to serve as an internal control
for input RNA. Each real-time RT-PCR assays was performed in triplicate and
standardized to threshold cycle values for each viral RNA from HFF cells infected with
Rwt crs at 4 d.p.i.

Viral DNA replication assay. After infection with an MOI of 1 or 0.01, cells were collected
at 2, 3, and 4 d.p.i. or 5 and 8 d.p.i., respectively. Cells in 35 mm plates in triplicate were
suspended in lysis buffer (50mM Tris-HCl, pH 8.0, 10mM EDTA, 1% SDS and 20µg/ml
RNase A) containing 50 µg/ml proteinase K. The replicated viral DNA was quantitated by
real-time PCR using HCMV gB primers and probes as described previously (Isomura,
Tsurumi et al. 2004; Isomura, Stinski et al. 2005). Real-time PCR with 18S primers and
probe purchased from Applied Biosystems (Foster City, CA.) were also performed to
serve as an internal control for input DNA. Data are averages of three independent
experiments.

5. Acknowledgement

I wish to thank Drs Mark Stinski and Tatsuya Tsurumi for their engagement, advice, and
review of various materials.

6. References

- Adam, B. L., T. Y. Jervy, et al. (1995). "The human cytomegalovirus UL98 gene transcription
unit overlaps with the pp28 true late gene (UL99) and encodes a 58-kilodalton early
protein." *J. Virol.* 69(9): 5304-5310.
- Carninci, P., A. Sandelin, et al. (2006). "Genome-wide analysis of mammalian promoter
architecture and evolution." *Nat Genet* 38(6): 626-35.
- Chang, C.-P., C. L. Malone, et al. (1989). "A human cytomegalovirus early gene has three
inducible promoters that are regulated differentially at various times after
infection." *J. Virol.* 63: 281-290.
- Dunn, W., C. Chou, et al. (2003). "Functional profiling of a human cytomegalovirus
genome." *Proc. Natl. Acad. Sci. U. S. A.* 100(24): 14223-14228.
- Ertl, P. R. and K. L. Powell (1992). "Physical and functional interaction of human
cytomegalovirus DNA polymerase and its accessory protein (ICP36) expressed in
insect cells." *J. Virol.* 66: 4126-4133.
- Gao, M. and D. M. Knipe (1991). "Potential role for herpes simplex virus ICP8 DNA
replication protein in stimulation of late gene expression." *J. Virol.* 65(5): 2666-
2675.

- Geballe, A. P., F. S. Leach, et al. (1986). "Regulation of cytomegalovirus late gene expression: gamma genes are controlled by posttranscriptional events." *J. Virol.* 57(3): 864-874.
- Hermiston, T. W., C. L. Malone, et al. (1987). "Identification and characterization of the human cytomegalovirus immediate-early region 2 gene that stimulates gene expression from an inducible promoter." *J. Virol.* 61: 3214-3221.
- Isomura, H. and M. F. Stinski (2003). "The human cytomegalovirus major immediate-early enhancer determines the efficiency of immediate-early gene transcription and viral replication in permissive cells at low multiplicity of infection." *J. Virol.* 77(6): 3602-3614.
- Isomura, H., M. F. Stinski, et al. (2005). "Two Sp1/Sp3 binding sites in the major immediate-early proximal enhancer of human cytomegalovirus have a significant role in viral replication." *J. Virol.* 79(15): 9597-9607.
- Isomura, H., T. Tsurumi, et al. (2004). "Role of the proximal enhancer of the major immediate-early promoter in human cytomegalovirus replication." *J. Virol.* 78(23): 12788-12799.
- Krosky, P. M., M. C. Baek, et al. (2003). "The human cytomegalovirus UL44 protein is a substrate for the UL97 protein kinase." *J. Virol.* 77(14): 7720-7727.
- Lashmit, P. E., M. F. Stinski, et al. (1998). "A cis-repression sequence adjacent to the transcription start site of the human cytomegalovirus US3 gene is required to down regulate gene expression at early and late times after infection." *J. Virol.* 72: 9575-9584.
- Leach, F. S. and E. S. Mocarski (1989). "Regulation of cytomegalovirus late-gene expression: differential use of three start sites in the transcriptional activation of ICP36 gene expression." *J. Virol.* 63: 1783-1791.
- Marchini, A., H. Liu, et al. (2001). "Human cytomegalovirus with IE-2 (UL122) deleted fails to express early lytic genes." *J. Virol.* 75(4): 1870-1878.
- McWatters, B. J., R. M. Stenberg, et al. (2002). "Characterization of the human cytomegalovirus UL75 (glycoprotein H) late gene promoter." *Virology.* 303(2): 309-316.
- Meier, J. L., M. J. Keller, et al. (2002). "Requirement of multiple cis-acting elements in the human cytomegalovirus major immediate-early distal enhancer for viral gene expression and replication." *J. Virol.* 76(1): 313-326.
- Meier, J. L. and J. A. Pruessner (2000). "The human cytomegalovirus major immediate-early distal enhancer region is required for efficient viral replication and immediate-early gene expression." *J. Virol.* 74(4): 1602-1613.
- Meier, J. L. and M. F. Stinski (1997). "Effect of a modulator deletion on transcription of the human cytomegalovirus major immediate-early genes in infected undifferentiated and differentiated cells." *J. Virol.* 71: 1246-1255.
- Nevels, M., W. Brune, et al. (2004). "SUMOylation of the human cytomegalovirus 72-kilodalton IE1 protein facilitates expression of the 86-kilodalton IE2 protein and promotes viral replication." *J. Virol.* 78(14): 7803-12.

- Nevels, M., C. Paulus, et al. (2004). "Human cytomegalovirus immediate-early 1 protein facilitates viral replication by antagonizing histone deacetylation." *Proc Natl Acad Sci U S A* 101(49): 17234-9. Epub 2004 Nov 30.
- Pari, G. S. and D. G. Anders (1993). "Eleven loci encoding trans-acting factors are required for transient complementation of human cytomegalovirus oriLyt-dependent DNA replication." *J. Virol.* 67: 6979-6988.
- Pari, G. S., M. A. Kacica, et al. (1993). "Open reading frames UL44, IRS1/TRS1, and UL36-38 are required for transient complementation of human cytomegalovirus oriLyt-dependent DNA synthesis." *J. Virol.* 67(5): 2575-2582.
- Park, M. Y., Y. E. Kim, et al. (2006). "Interactions among four proteins encoded by the human cytomegalovirus UL112-113 region regulate their intranuclear targeting and the recruitment of UL44 to prereplication foci." *J Virol* 80(6): 2718-27.
- Penfold, M. E. and E. S. Mocarski (1997). "Formation of cytomegalovirus DNA replication compartments defined by localization of viral proteins and DNA synthesis." *Virology* 239(1): 46-61.
- Ponjavic, J., B. Lenhard, et al. (2006). "Transcriptional and structural impact of TATA-initiation site spacing in mammalian core promoters." *Genome Biol* 7(8): R78.
- Ripalti, A., M. C. Bocconi, et al. (1995). "Cytomegalovirus-mediated induction of antisense mRNA expression to UL44 inhibits virus replication in an astrocytoma cell line: identification of an essential gene." *J. Virol.* 69(4): 2047-2057.
- Stinski, M. F. (1978). "Sequence of protein synthesis in cells infected by human cytomegalovirus: early and late virus-induced polypeptides." *J. Virol.* 26: 686-701.
- Taylor, T. J. and D. M. Knipe (2004). "Proteomics of herpes simplex virus replication compartments: association of cellular DNA replication, repair, recombination, and chromatin remodeling proteins with ICP8." *J. Virol.* 78(11): 5856-5866.
- Wang, D. and T. Shenk (2005). "Human cytomegalovirus UL131 open reading frame is required for epithelial cell tropism." *J. Virol.* 79(16): 10330-8.
- Wang, S. K., C. Y. Duh, et al. (2004). "Human cytomegalovirus UL76 encodes a novel virion-associated protein that is able to inhibit viral replication." *J. Virol.* 78(18): 9750-9762.
- Weiland, K. L., N. L. Oien, et al. (1994). "Functional analysis of human cytomegalovirus polymerase accessory protein." *Virus Res.* 34(3): 191-206.
- White, E. A., C. L. Clark, et al. (2004). "Small internal deletions in the human cytomegalovirus IE2 gene result in nonviable recombinant viruses with differential defects in viral gene expression." *J. Virol.* 78(4): 1817-1830.
- Wing, B. A. and E. S. Huang (1995). "Analysis and mapping of a family of 3'-coterminal transcripts containing coding sequences for human cytomegalovirus open reading frames UL93 through UL99." *J. Virol.* 69(3): 1521-1531.
- Yu, D., M. C. Silva, et al. (2003). "Functional map of human cytomegalovirus AD169 defined by global mutational analysis." *Proc. Natl. Acad. Sci. U. S. A.* 100(21): 12396-12401.

Zuccola, H. J., D. J. Filman, et al. (2000). "The crystal structure of an unusual processivity factor, herpes simplex virus UL42, bound to the C terminus of its cognate polymerase." *Mol. Cell* 5(2): 267-278.

IntechOpen

IntechOpen

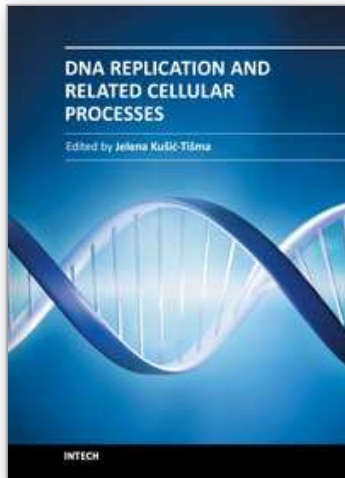

DNA Replication and Related Cellular Processes

Edited by Dr. Jelena Kusic-Tisma

ISBN 978-953-307-775-8

Hard cover, 300 pages

Publisher InTech

Published online 26, September, 2011

Published in print edition September, 2011

Since the discovery of the DNA structure researchers have been highly interested in the molecular basis of genome inheritance. This book covers a wide range of aspects and issues related to the field of DNA replication. The association between genome replication, repair and recombination is also addressed, as well as summaries of recent work of the replication cycles of prokaryotic and eukaryotic viruses. The reader will gain an overview of our current understanding of DNA replication and related cellular processes, and useful resources for further reading.

How to reference

In order to correctly reference this scholarly work, feel free to copy and paste the following:

Hiroki Isomura (2011). DNA Polymerase Processivity Factor of Human Cytomegalovirus May Be a Key Molecule for Molecular Coupling of Viral DNA Replication to Transcription, DNA Replication and Related Cellular Processes, Dr. Jelena Kusic-Tisma (Ed.), ISBN: 978-953-307-775-8, InTech, Available from: <http://www.intechopen.com/books/dna-replication-and-related-cellular-processes/dna-polymerase-processivity-factor-of-human-cytomegalovirus-may-be-a-key-molecule-for-molecular-coupling>

INTECH
open science | open minds

InTech Europe

University Campus STeP Ri
Slavka Krautzeka 83/A
51000 Rijeka, Croatia
Phone: +385 (51) 770 447
Fax: +385 (51) 686 166
www.intechopen.com

InTech China

Unit 405, Office Block, Hotel Equatorial Shanghai
No.65, Yan An Road (West), Shanghai, 200040, China
中国上海市延安西路65号上海国际贵都大饭店办公楼405单元
Phone: +86-21-62489820
Fax: +86-21-62489821

© 2011 The Author(s). Licensee IntechOpen. This chapter is distributed under the terms of the [Creative Commons Attribution-NonCommercial-ShareAlike-3.0 License](#), which permits use, distribution and reproduction for non-commercial purposes, provided the original is properly cited and derivative works building on this content are distributed under the same license.

IntechOpen

IntechOpen