

We are IntechOpen, the world's leading publisher of Open Access books Built by scientists, for scientists

4,400

Open access books available

117,000

International authors and editors

130M

Downloads

Our authors are among the

154

Countries delivered to

TOP 1%

most cited scientists

12.2%

Contributors from top 500 universities



WEB OF SCIENCE™

Selection of our books indexed in the Book Citation Index
in Web of Science™ Core Collection (BKCI)

Interested in publishing with us?
Contact book.department@intechopen.com

Numbers displayed above are based on latest data collected.
For more information visit www.intechopen.com



Pre-Processing Tools and Intelligent Systems Applied to Power Quality Analysis

Ricardo A. S. Fernandes¹, Ricardo A. L. Rabêlo¹, Daniel Barbosa²,
Mário Oleskovicz¹ and Ivan Nunes da Silva¹

¹Engineering School of São Carlos, University of São Paulo (USP),

²Salvador University (UNIFACS)

Brazil

1. Introduction

In the last few years the power quality has become the target of many researches carried out either by academic or by utility companies. Moreover, a desired good power quality is essential for the Power Distribution System (PDS). The PDS can have (or impose) inherent operational conditions, that affect frequency and three-phase voltage signals. Among the main disturbances that indicate a poor power quality, the following can be highlighted: voltage sag/swell, overvoltage, undervoltage, interruption, oscillatory transient, noise, flicker and harmonic distortion (Dugan et al., 2003).

Actually, in literature, a diversity of papers can be found concerning detection and identification of power quality disturbances by applying intelligent systems, such as Artificial Neural Networks (ANN) (Janik & Lobos, 2006; Oleskovicz et. al., 2009; Jayasree, Devaraj & Sukanesh, 2010) and Fuzzy Inference Systems (Zhu, Tso & Lo, 2004; Hooshmand & Enshae, 2010; Meher & Pradhan, 2010; Behera, Dash & Biswal, 2010). However, only some papers use data pre-processing tools before the application of intelligent systems. Among these papers, the use of Discrete Wavelet Transform (DWT) (Zhu, Tso & Lo, 2004; Uyar, Yildirim & Gencoglu, 2008; Oleskovicz et. al., 2009) and Discrete Fourier Transform (DFT) (Zhang, Li & Hu, 2011) can be highlighted in the pre-processing stage. According to the literature, it should also be mentioned that the pre-processing tools help to ensure a better detection and identification of disturbances in the power quality context.

In Hooshmand & Enshae (2010), the authors propose a new method for detecting and classifying power quality disturbances. However, this method can be used both for the occurrence of one and multiple disturbances. This is a method that uses techniques for data pre-processing combined with intelligent systems. In this case, the authors extracted features of a time-varying voltage signal, such as:

- Fundamental component;
- Phase angle shift;
- Total harmonic distortion;
- Number of the maximums of the absolute value of wavelet coefficients;
- Calculation of energy of the wavelet coefficients;

- Number of zero-crossing of the missing voltage; and
- Number of peaks of Root Mean Square (RMS) value.

After the pre-processing step, the authors conducted the detection and classification of disturbances by means of an hybrid intelligent system where two fuzzy systems were developed (one being the detector and other the classifier of the disturbances). However, what classifies this intelligent system as hybrid is the use of Particle Swarm Optimization (PSO) to tune/adjust the membership functions. The results obtained tries to validate the proposed methodology, where it was found satisfactory correctness rate.

In the paper done by Jayasree, Devaraj & Sukanesh (2010), the authors employ the Hilbert Transform (HT) as pre-processing stage instead of the Fourier or Wavelet Transforms, which are commonly used for the same purpose (detect and/or classify power quality disturbances). So, after obtaining the coefficients from the HT, the following calculations are performed: mean, standard deviation, peak value and energy. Thus, each of these statistical calculations are submitted to the inputs of the Radial Basis Function (RBF) neural network that is responsible for classifying the disturbances contained in the measured voltage signal. Despite the good results achieved by the proposed method, tests were also performed, where was replaced the HT by DWT and S-Transform. Another test was done by replacing the RBF neural network by a Multilayer Perceptron (MLP) with Backpropagation training algorithm and by a Fuzzy ARTMAP. Thus, the proposed method, which is based on HT and RBF neural network, presents better response in terms of accuracy.

In Zhu, Tso & Lo (2004), a wavelet neural network was proposed for disturbances classification. However, a pre-processing step based on entropy calculation was accomplished. The results presented evidenced the potential of the proposed method for disturbances classification even under the influence of noise.

Among the intelligent systems used for power quality analysis, ANN and Fuzzy Inference Systems are the most applied, as mentioned before. Intelligent systems are used because they present, as inherent characteristics, the possibility of extracting the system dynamic and being able to generalize the response provided from the system. The intelligent systems are normally applied to the pattern recognition, functional approximation and processes optimization.

Taking this into account, the main purpose of this chapter is to present a collection of tools for data pre-processing including the DWT (Addison, 2002), fractal dimension calculation (Al-Akaidi, 2004), Shannon entropy (Shannon, 1948) and signal energy calculation (Hu, Zhu & Zhang, 2007). In addition to the detailed implementation of these tools, this chapter will be developed focusing on the pre-processing efficiency, considering and analyzing simulated data, when used before the intelligent system application. The results from this application show that the global performance of intelligent systems, together with the pre-processing data, was highly satisfactory concerning accuracy of response.

The performance of the methodology proposed was analyzed by simulated data via ATP software (EEUG, 1987). In this case, a lot of measures were obtained by the power distribution system simulated under power quality disturbances conditions, such as: voltage sags, voltage swells, oscillatory transients and interruptions. The next step was to submit the voltage measured in the substation to the windowing. Thus, the intelligent systems have been tested on data with and without pre-processing stage. This methodology allowed to verify the improvement in power quality analysis. The results showed the efficiency of the pre-processing tools combined with the intelligent systems.

2. Pre-processing tools

In this chapter, four main pre-processing tools will be presented, which are: Discrete Wavelet Transform, Fractal Dimension, Shannon Entropy and Signal Energy.

2.1 Discrete Wavelet Transform

The Wavelet Transform (WT) has been widely used because of its most relevant features: the possibility of examining a signal simultaneously in time and frequency (Addison, 2002). Although the WT have arisen in the mid-1980s, it started to be used only by engineering in the 1990s (Addison, 2002). It is worth mentioning that the WT calculation can be performed in a continuous or discrete manner, however, in the power quality area and, more specifically in detection and classification of disturbances, it is common to use the Discrete Wavelet Transform (DWT) (Oleskovicz et. al., 2009; Moravej, Pazoki & Abdoos, 2011). The DWT can be better understood through Figure 1.

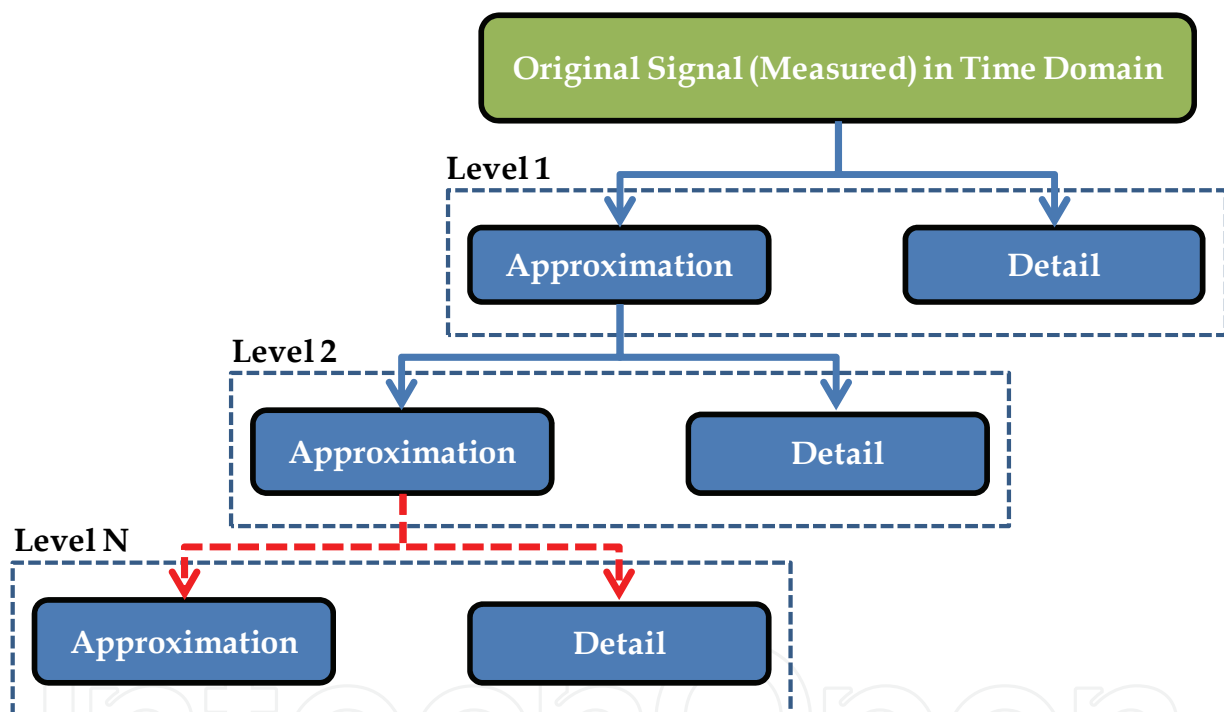

Fig. 1. Illustrative example of decomposition performed by wavelet transform

As shown in Figure 1, the WT allows the decomposition of a discrete signal in time into two levels, which are called approximation and detail. The approximations store the information concerning the low frequency components, while the details store the high frequency information. As the WT is applied to the signal, it is decomposed into other levels. Such levels are known as the leaves of the decomposition wavelet tree.

From level 1, the filtered signal is decomposed into other levels from the leaf of detail, resulting in the process of downsampling by 2 (Walker, 1999), where the number of samples is reduced to half (approximation and detail of level 2) of the parent leaf (detail of level 1), as well as the frequency. This process allows us to say that with the increment of decomposition levels, the resolution in frequency increases, but the resolution in time decreases.

Normally, in some literature, the term multi-resolution can be found linked with WT. This term refers to the time-frequency decomposition; however, in this case it is necessary to finish the wavelet decomposition in an intermediate level. This way, a good resolution both in frequency and time domain can be ensured.

In summary, the WT can also be defined as the application of an analysis filter, which is composed by two filters (low-pass and high-pass). However, the inverse process can be performed, where a synthesis filter can be applied to obtain the original signal from the decomposed/filtered signal. These process can be viewed in Figure 2.

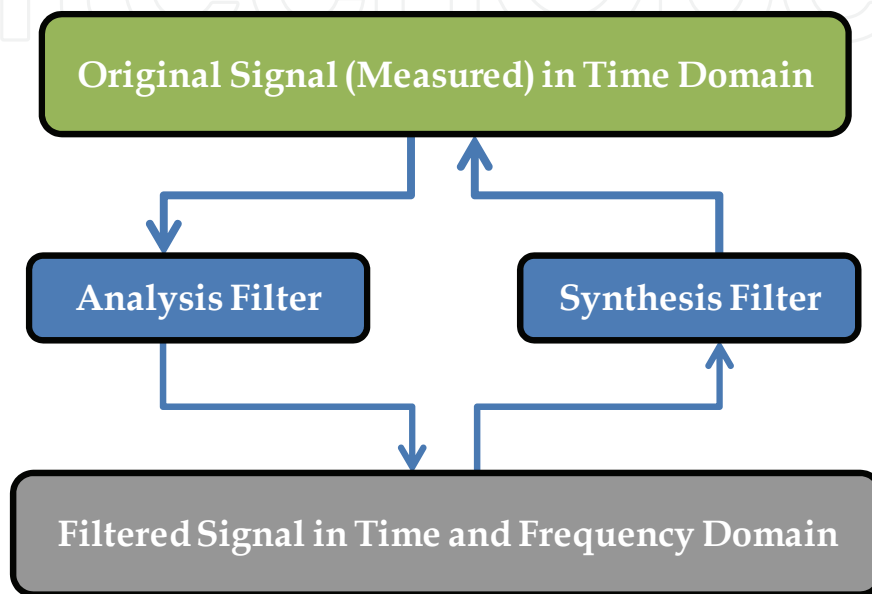

Fig. 2. Bank of filters used by wavelet transform

These filters are applied to the signal through the temporal convolution of its coefficients with the signal coefficients.

It is important to mention that there are a lot of filter families, but these filters can only be characterized as a Wavelet Transform if the synthesis and analysis filters are orthogonal to each other (Daubechies, 1992).

Another important factor to be taken into account is that the response of WT is better if the filters have more coefficients. However, this amount of coefficients must respect the size of the original signal, because of delays and processing time.

2.2 Shannon entropy

In the analysis of signals, the entropy is defined as a measure of knowledge lack about the information in the signal. Therefore, less noisy signals also have lower entropy (Shannon, 1948). The calculation of the Shannon entropy can be done according to equation (1):

$$S = \sum_{i=1}^N p_i \cdot \log(p_i) \quad (1)$$

where, N corresponds to the i -th window of the signal and p represents the normalized energy of the window.

2.3 Signal energy

The signal energy is calculated to achieve the full potential of a signal (Hu, Zhu & Zhang, 2007). However, some signals have negative sides and therefore a quadratic sum of the sampled points must be calculated as shown in the equation (2):

$$E = \sum_{i=1}^N \sum_{j=1}^M \text{signal}_{i,j}^2 \quad (2)$$

where, N corresponds to the i -th window and M represents the j -th point of the window.

2.4 Fractal dimension

The fractal dimension has been calculated by using the DWT at the maximum level of the signal. The maximum level of a window or signal can be obtained by the following equation:

$$\text{level}_{\max} = \frac{\log(n)}{\log(2)} \quad (3)$$

where n is the number of points of each considered window/signal.

It is important to emphasize that, for a better response of the fractal dimension, the mother-wavelet used by DWT must normally have a lot of support coefficients (over 15), because this ensures a more symmetrical response to the impulse (Al-Akaidi, 2004).

After the DWT is applied, two vectors, $x[.]$ and $y[.]$ were generated, containing the details length of each wavelet sub band and the energy of each of these sub bands respectively. The procedure for the creation of vectors $x[.]$ and $y[.]$ can be seen in Figure 3. In this figure the calculation of fractal dimension about a 32-point-window was considered. Once the vectors are determined, the fractal dimension can be calculated according to equation (4):

$$D = 2 - \left| \frac{\beta - 1}{2} \right| \quad (4)$$

where, β is the angle of the average line that sets the points given by the vectors $x[.]$ (length of each leaf) and $y[.]$ (energy of each leaf), by means of the least squares method. The calculation of least squares can be done according to the following equation:

$$\beta = \frac{j \sum_k \log_2(x_k) \cdot \log_2(y_k) - \sum_k \log_2(y_k) \cdot \sum_k \log_2(x_k)}{j \sum_k \log_2(x_k)^2 - \left(\sum_k \log_2(x_k) \right)^2} \quad (5)$$

where, j is the signal length, x_k corresponds to the vector $x[.]$ at its k -th position and y_k corresponds to the vector $y[.]$ at its k -th position.

The DWT employed in this study was configured using a Symmlet mother-wavelet with 16 support coefficients.

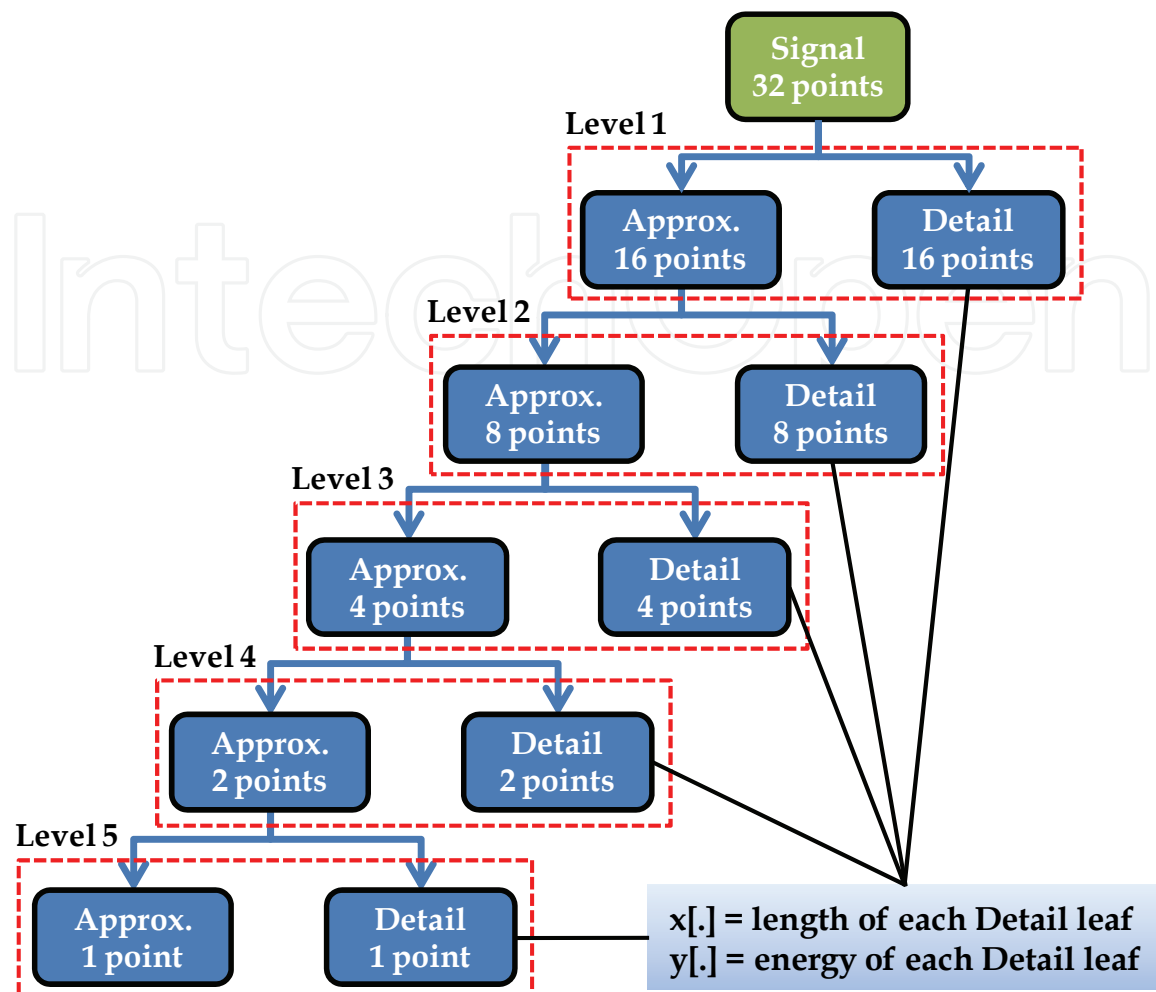

Fig. 3. Calculation of fractal dimension using DWT

3. Intelligent systems

Since the 1990s, intelligent systems have been widely used in researches related to electrical engineering, where the Artificial Neural Networks and Fuzzy Systems are highlighted. However, in recent years the development of hybrid intelligent tools, that combine neural networks and fuzzy systems together with evolutionary algorithms (genetic algorithms and particle swarm optimization), has been increasing. Following the outlined context, this section aims to present the foundations of intelligent systems, namely, artificial neural networks, adaptive neural-fuzzy inference systems and neural-genetic.

3.1 Artificial Neural Networks

Artificial Neural Networks are computational models inspired in human brain, which may acquire and maintain the knowledge. In this chapter, only ANN with MLP architecture will be presented. This architecture is generally applied in pattern recognition, functional approximation, identification and control (Haykin, 1999). Hence, considering the pattern recognition task, this architecture might be applied to disturbances classification. The MLP architecture previously commented is shown in Figure 4.

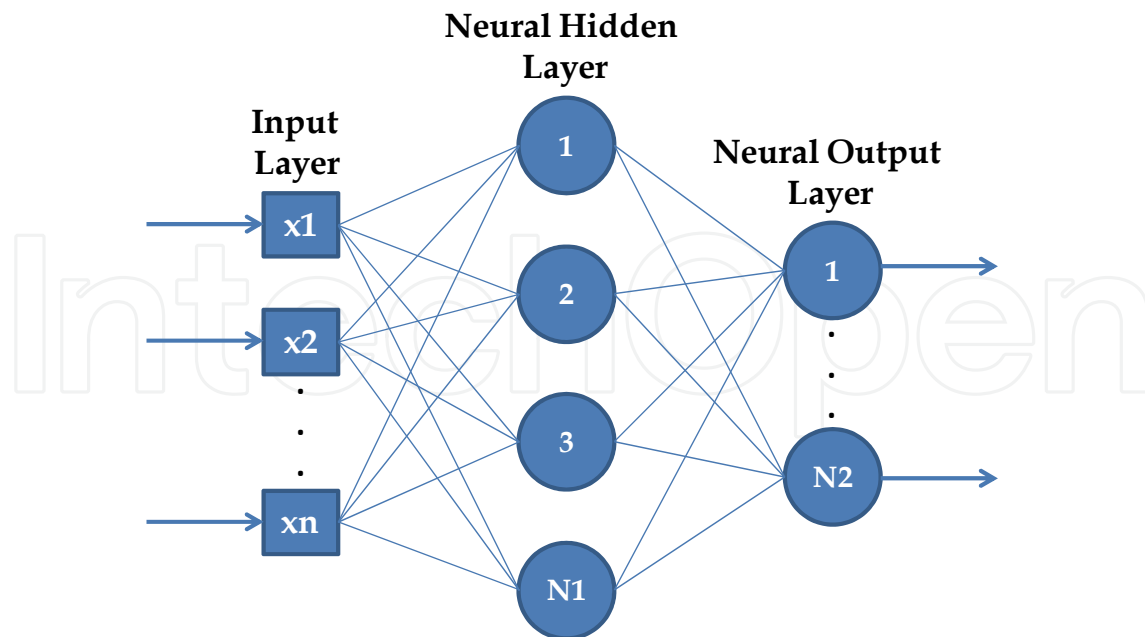

Fig. 4. Architecture of MLP neural networks

The MLP neural networks commonly use as training algorithm the Backpropagation (BP), however, other algorithms such as Levenberg-Marquardt (LM) and Resilient Backpropagation (RPROP) should be employed. In this chapter, these algorithms will be used and will have its performance evaluated.

Backpropagation training algorithm was employed because it is commonly used to train MLP neural networks. The Levenberg-Marquardt training algorithm was employed due to its capacity of accelerating the convergence process. This training algorithm consists in one approximation of the Newton method to non-linear systems (Hagan & Menhaj, 1994). On the other hand, the Resilient Backpropagation was employed due to its capacity of eliminating the harmful effect. This effect is caused by the partial derivatives in the training process. Thus, only the signal of partial derivatives is used to update the synaptic weights (Riedmiller & Braun, 1993).

3.2 Adaptive Neural-Fuzzy Inference Systems (ANFIS)

Fuzzy inference systems are capable of dealing with highly complex processes, which are represented by inaccurate, uncertain and qualitative information. Normally, fuzzy inference systems are based on linguistic rules of type "if ... then", in which the fuzzy set theory (Zadeh, 1965) and fuzzy logic (Zadeh, 1996) provide the necessary mathematical basis to deal with inaccurate information and with the linguistic rules.

In general, fuzzy inference systems are often based on three steps: fuzzification, inference procedures and defuzzification. Normally, in fuzzy inference systems, non-fuzzy inputs (crisp) are considered; resulting from observations or measurements, that is the case of most practical applications. As a result, it is necessary to make a mapping of these data to the fuzzy sets (input). The fuzzification is a mapping from the input variable domain to the fuzzy domain, representing the assignment of linguistic values (primary terms), defined by membership functions, to the input variables. The fuzzy inference procedure is responsible for evaluating the primary terms of the input variables, by applying production rules

(stored on fuzzy rule base) in order to obtain the fuzzy output value of inference system. Once the fuzzy output set is obtained, in the stage of defuzzification, an interpretation of this information is performed. This step is necessary because, in practical applications, accurate outputs are normally required. The defuzzification is typically used to assign a numerical value to the fuzzy output set. Thus, defuzzification can be considered a kind of synthesis of the final fuzzy output set by means of a numerical value. In the Figure 5, a block diagram representing the components of fuzzy inference systems commented above can be visualized.

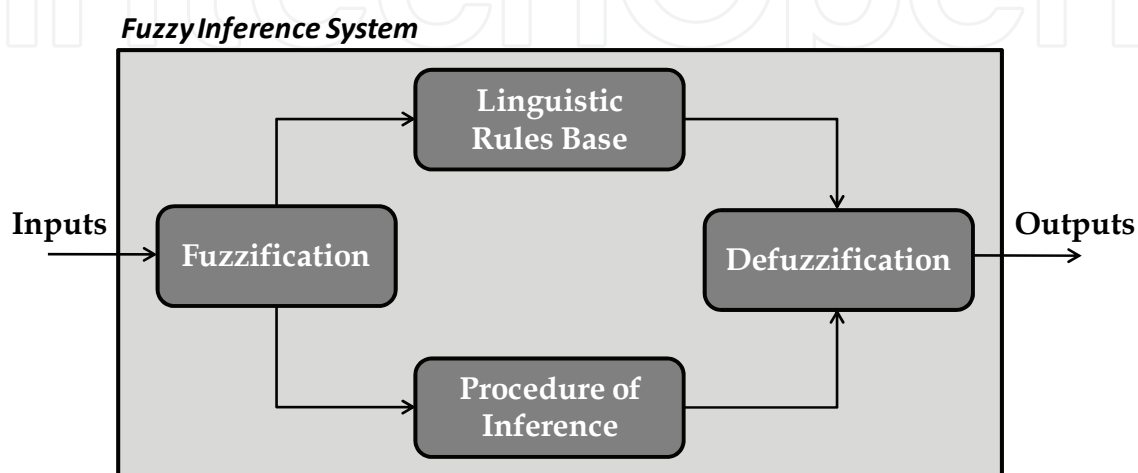

Fig. 5. Structure of a fuzzy inference system

However, this subsection is intended to neural-fuzzy inference systems that differ from a conventional fuzzy system for obtaining and tuning/adjustment of the linguistic rules base. When using a neural-fuzzy inference system, rules and fuzzy sets are adjusted and tuned by information contained in the data set. It is worth commenting also that the adaptive neural-fuzzy inference system is based on the Takagi-Sugeno inference model (Takagi & Sugeno, 1985), where a linguistic rule is given as follows:

$$R_i : \text{If } \mu_1 \text{ is } A_1 \text{ and } \mu_2 \text{ is } A_2 \text{ Then } y_i = B_i$$

and, the final result is obtained by the weighted average of all results found in each activated rule (R_i), i.e.:

$$y = \frac{\sum_{i=1}^N \mu_i \cdot y_i}{\sum_{i=1}^N \mu_i} \quad (6)$$

where, y is the output of the system, N denotes the total number of rules activated and μ_i is the membership degree to each activated rule.

3.3 Neural-genetic

The neural-genetic system presented in this subsection has been fully based on the architecture of an MLP neural network as well as that presented in Figure 4. However, the

neural network training step is performed by a genetic algorithm instead of the methods normally used for this type of network (Backpropagation, Levenberg-Marquardt, Resilient Backpropagation). Thus, the genetic algorithm becomes responsible for estimating the best matrix of synaptic weights, i.e., a good solution inside the search space.

Genetic Algorithms (GA) are methods applied to search and optimization, which are based on the principles of natural selection and survival of the best individuals as defined by Charles Darwin in 1859. In addition, the functioning of genetic algorithms depends on the adjustment of the genetic operators (selection, crossover and mutation). Thus, the Figure 6 illustrates a flowchart representing the operation of a basic genetic algorithm.

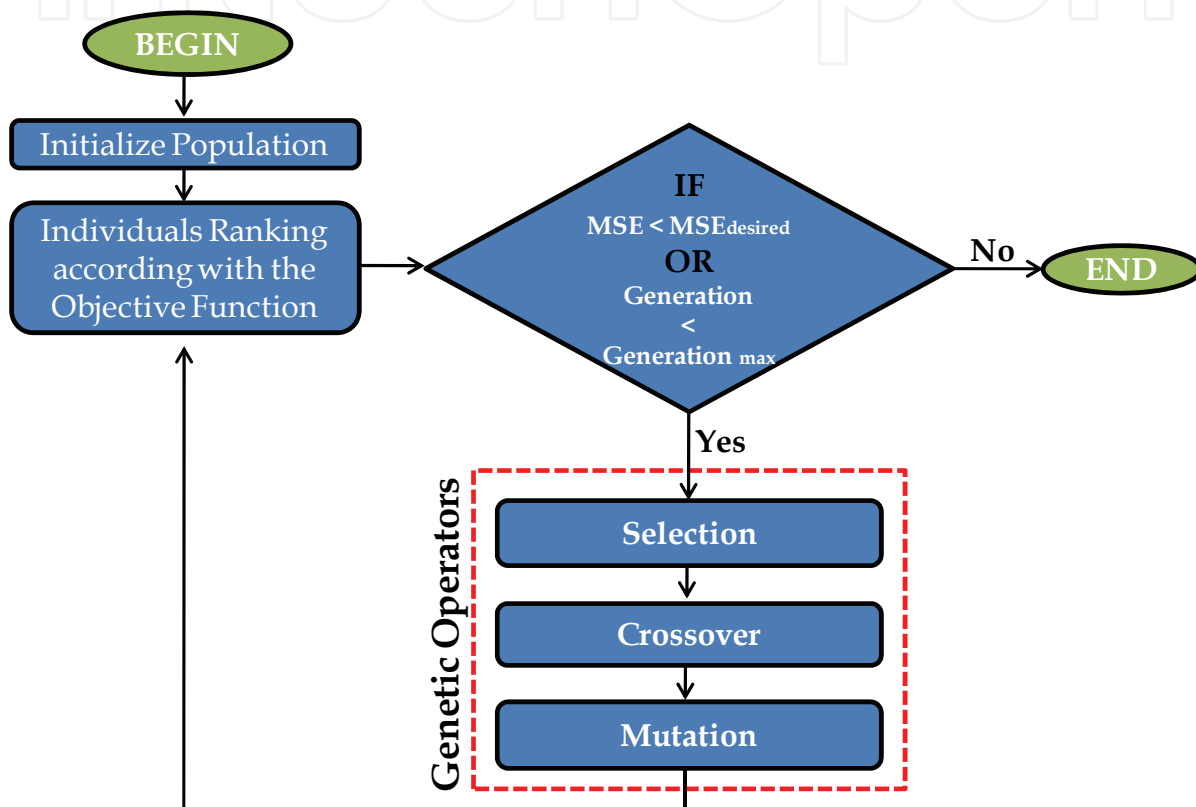

Fig. 6. Flowchart of a basic genetic algorithm

Through the Figure 6, firstly the population of individuals or chromosomes is initialized by means of a uniform distribution. Each individual represents a solution to the problem that is subsequently evaluated by the objective function, which becomes, in this case, the calculation of the Mean Square Error (MSE). Thus, it can be noted that the individual must be better if the MSE is minor. It is important to mention that the GA does not stop its execution until a stopping criterion is satisfied. In this case, two variables are normally employed as stopping criterion: the maximum number of generations and the expected value of MSE. In this chapter, the GA used was parameterized in order to have an elitist selection (De Jong, 1975), i.e., only the best individual was maintained for the next generation. In addition, a BLX- α crossover and a Gaussian mutation were used. So, the individuals of the next generation were obtained by using the following equation:

$$m = p_1 + \alpha(p_2 - p_1) \quad (7)$$

where, p_1 is the actual individual, p_2 is the best individual of the current generation, α is a free parameter that must belong to the search space and m represents the new individual. After the new individuals are obtained, a portion of these individuals has to go through the Gaussian mutation. This mutation replaces a gene of the individual by a random number provided by a Gaussian distribution. Thus, given an individual p with its n -th gene selected, an individual m will be obtained as follows:

$$m = \begin{cases} D(p_i, \sigma), & \text{if } i = n \\ p_i & \end{cases} \quad (8)$$

where, $D(p_i, \sigma)$ is a Gaussian distribution with its mean in p_i and a standard deviation of σ that is a free parameter. However, the mutation operator is usually dynamic, so it checks whether the best individual is improving or not during a certain number of generations. If the best individual is kept during this pre-defined number of generations, a greater number of individuals will be mutated. This strategy is adopted as an attempt to avoid local minima points (Goldberg, 1989). The parameters of GA used are shown by means of Table 1.

Selection Method	Elitism
Crossover Method	BLX- α
Mutation Method	Gaussian
α parameter (crossover)	0.3
Standard deviation (mutation)	0.5
Minimum MSE (stopping criterion)	e-9
Maximum of Generations (stopping criterion)	1000

Table 1. Parameters of the genetic algorithm

4. Distribution power system simulated

The computer simulation has been developed using the ATP (Alternative Transients Program) software, which is properly used for modeling a real distribution system. It should be emphasized that the system has been designed by using data provided by a local utility. The ATP software enables the configuration of all parameters needed to construct the model and the variables to extract the disturbances data. Then, it can be stated that it was modeled to have great similarity with those found in the field. For all simulated situations, the sampling rate of 7680Hz has been considered. The power system modeled through ATP can be seen in Figure 7.

With respect to Figure 7, the substation transformer (138 Δ /13.8 Y kV, 25MVA), the distribution transformers T3 and T13 (45kVA) and the particular transformer TP4 (45kVA) has been modeled according to their real saturation curves. The other transformers have been modeled without considering their saturation curves. It should be noticed that both the distribution transformers and the particular ones have Δ -Y connections with the grounding resistance of zero ohm.

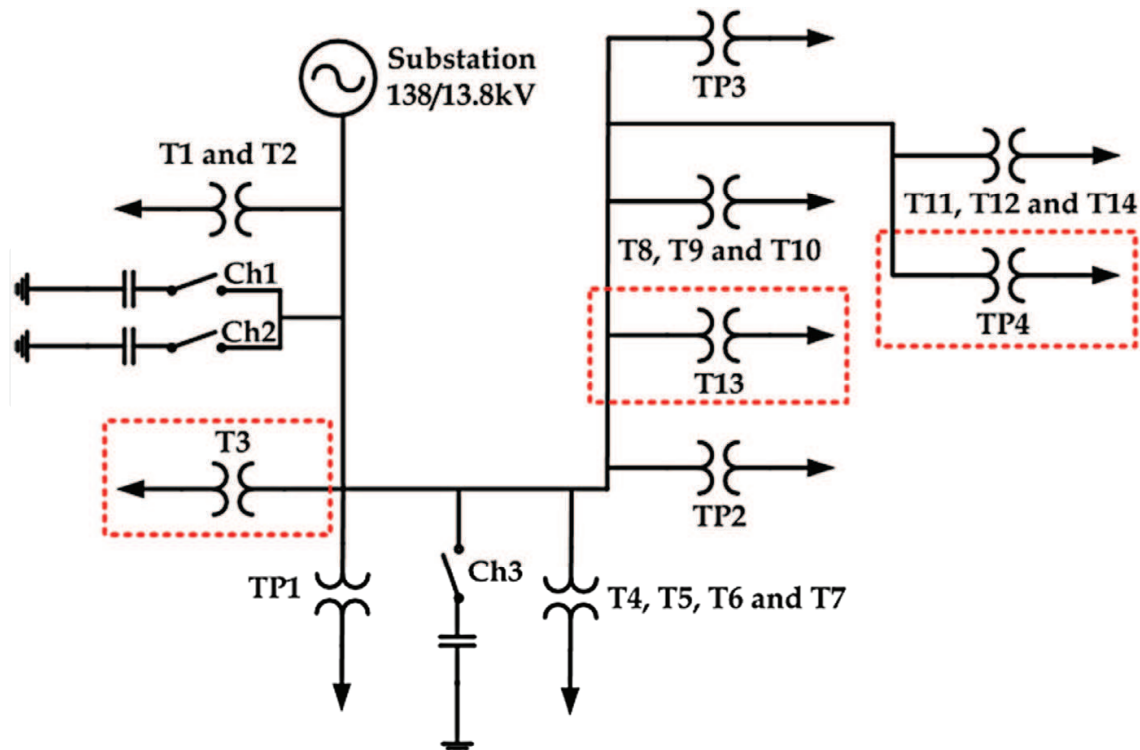

Fig. 7. Distribution Power System Simulated

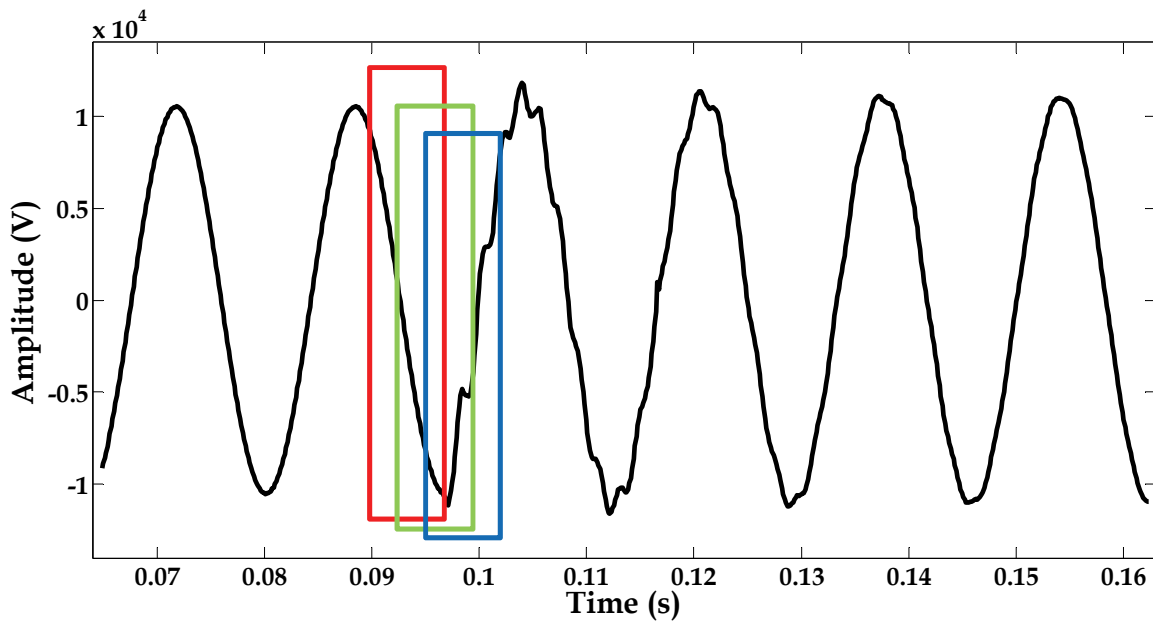

Fig. 8. Moving window process

The loads connected to these transformers represent a similar approach to that found in practice.

It can also be verified that, in the distribution system previously mentioned, there are three banks of capacitors, two of them been modeled for 600kVAr and the other for 1,200kVAr.

The cabling of the main feeder consists of a CA-477 MCM bare cable in a conventional overhead structure represented by coupled RL elements.

As the analyzed power system has been simulated, the extraction of data is given by the ATP software at a sampling rate of 7680 Hz.

In order to test the proposed technique, 89 cases have been generated to form a representative database, which was divided in:

- 34 cases of voltage sags;
- 28 cases of voltage swells;
- 15 cases of oscillatory transients; and
- 12 cases of interruptions.

Considering these events, windowing of data signal has been necessary to create a homogeneous database, and to better prepare the data to the pre-processing stage. Thus, a window containing 32 samples/points, which corresponds to a quarter of the cycle of the analyzed voltage signal has been used. It is worth mentioning that the window of data moves in a step of 8 samples. An example of this window is showed in Figure 8.

5. Data pre-processing and disturbances analysis

In this section, the disturbances detection will be presented by means of fractal dimension calculation, which is based on WT. It is worth mentioning that the method can be applied to both entire signal and window of signal. In the sequence, four examples of fractal dimension calculation applied to disturbances detection are shown by Figures 9 to 13. As the fractal dimension uses a Wavelet Transform, this one was configured using a Symmlet mother-wavelet with 16 support coefficients. The windowing of the signal was done using a 32-points window, which corresponds to a quarter of the cycle of original measured signal.

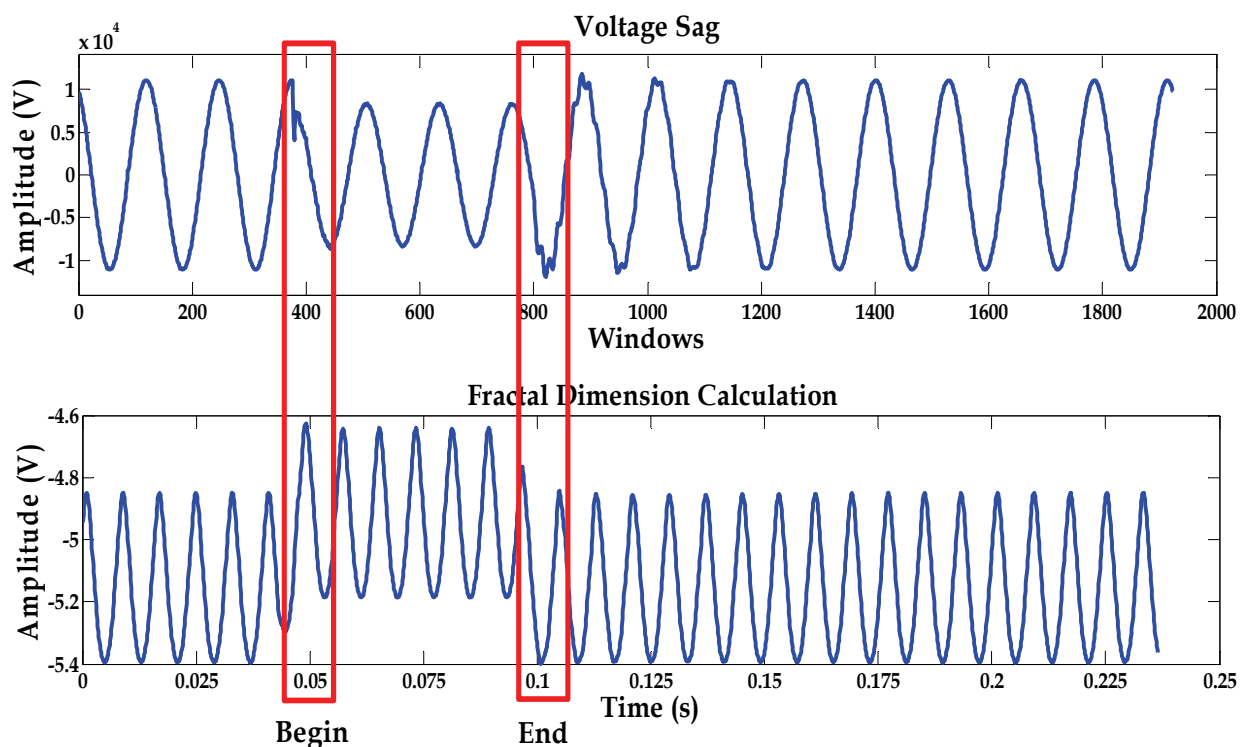

Fig. 9. Fractal dimension calculation applied to a voltage signal containing sag

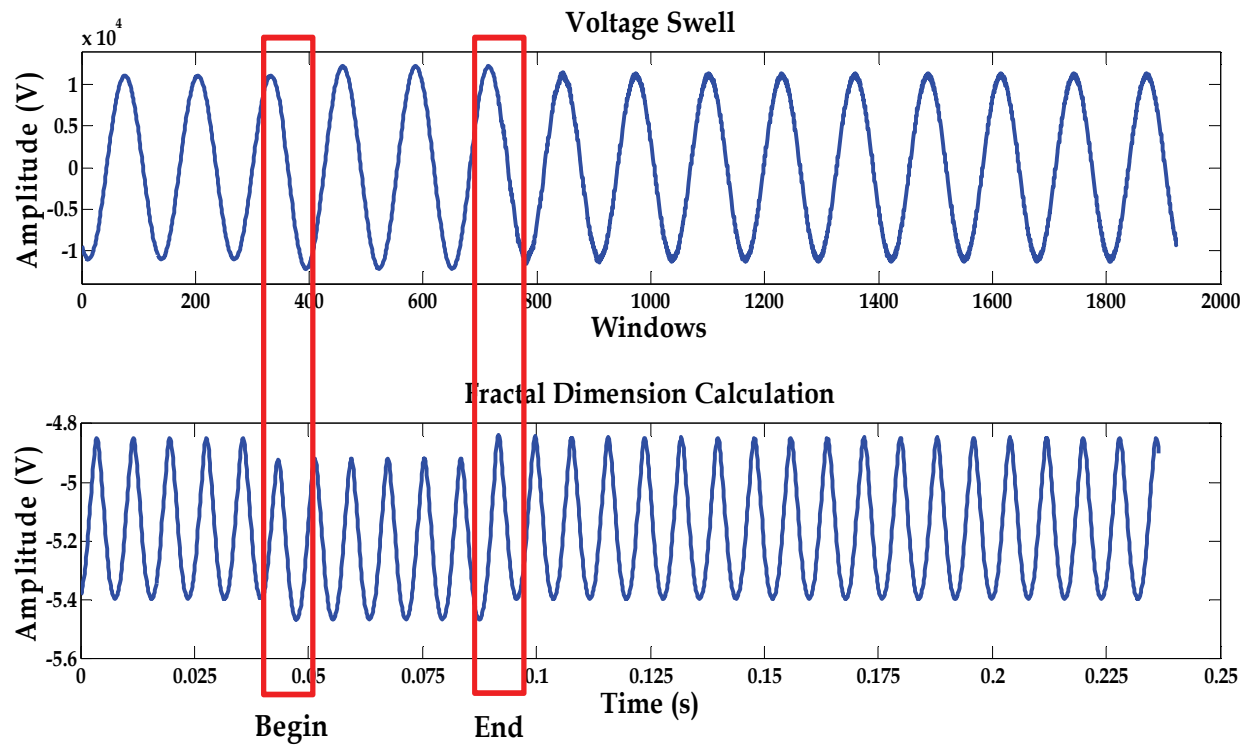

Fig. 10. Fractal dimension calculation applied to a voltage signal containing swell

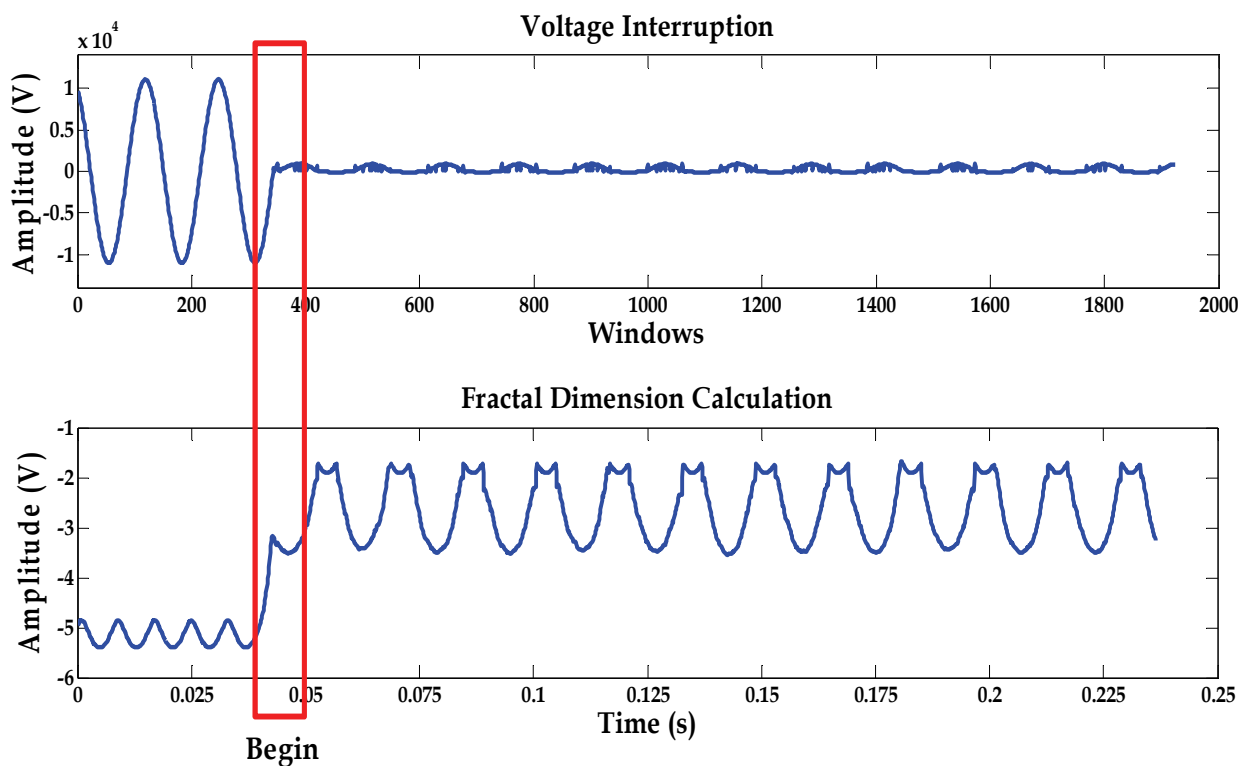

Fig. 11. Fractal dimension calculation applied to a voltage signal containing interruption

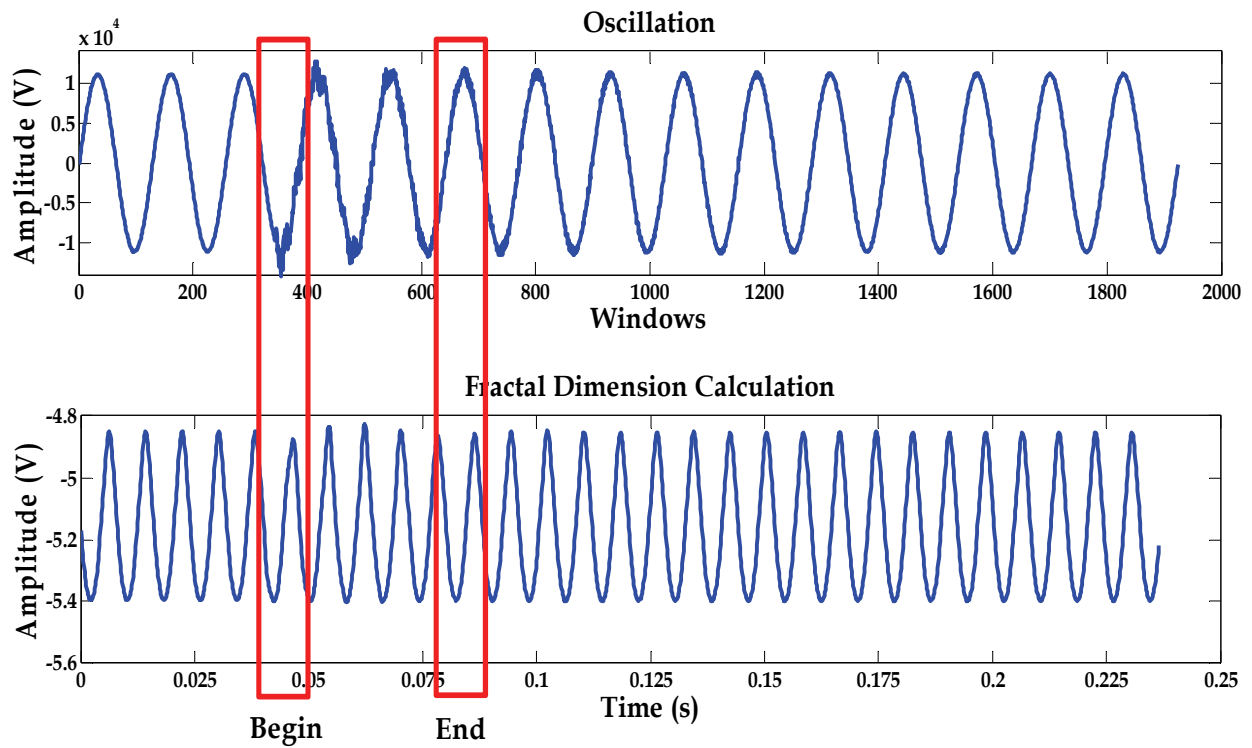

Fig. 12. Fractal dimension calculation applied to a voltage signal containing oscillation

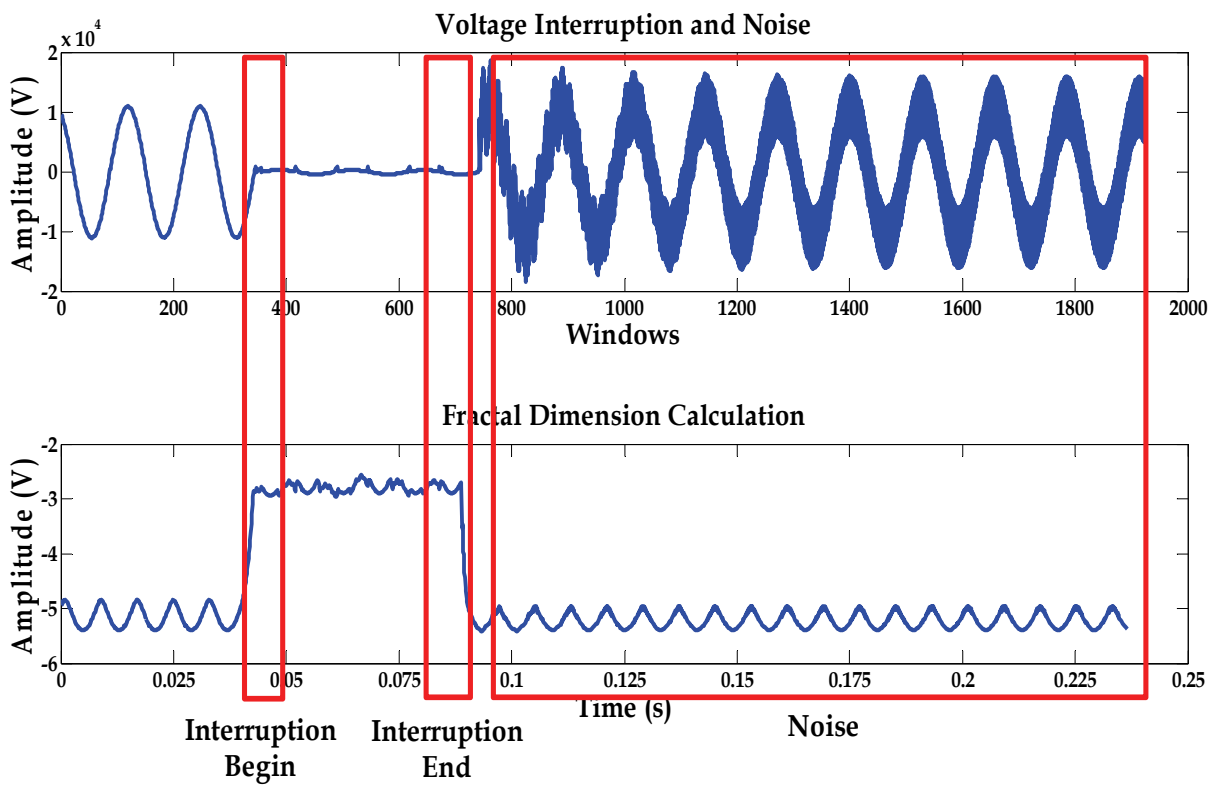

Fig. 13. Fractal dimension calculation applied to a voltage signal containing interruption and noise

The figures above show an easy characterization of the disturbances, as well as its temporal positions.

It is noteworthy that after the detection of disturbances, there is still a need to classify them. Following this premise, classifiers were implemented based on intelligent systems, which were previously mentioned in Section 3. The disturbances classification was first accomplished by providing a 32-points window of signal directly to the inputs of intelligent systems. This test was done in order to show that the pre-processing is an extremely important step for classification of power quality disturbances. The results obtained by this classification are shown in Table 2.

Disturbances	Accuracy of MLP Neural Networks (%)			Accuracy of Hybrid Intelligent Systems (%)	
	BP	LM	RPROP	ANFIS	Neural-Genetic
Sags	75.9	98.1	98.3	-	59.0
Swells	95.9	96.4	98.1	-	67.1
Interruptions	96.6	100	100	-	85.9
Oscillations	84.4	99.0	96.8	-	83.3

Mean (%)	88.2	98.4	98.3	-	73.7
-----------------	-------------	-------------	-------------	----------	-------------

Table 2. Performance of intelligent systems without pre-processing stage

Some disturbances presented by Table 2 reach good results, but the mean percentage, mainly for neural-genetic and MLP with Backpropagation training algorithm were low. Besides of this, ANFIS is not capable to run because of the huge number of input signals. In this way, a new test was performed, where a pre-processing stage was used based on fractal dimension, Shannon entropy and energy. The results for this new test can be verified in Table 3.

Disturbances	MLP Neural Networks			Hybrid Intelligent Systems	
	BP	LM	RPROP	ANFIS	Neural-Genetic
Sags	94.2	100	99.5	94.0	85.8
Swells	92.2	100	99.8	94.8	88.8
Interruptions	99.9	100	100	100	83.2
Oscillations	89.9	100	99.6	88.8	98.5

Mean	94.1	100	99.7	94.4	89.1
-------------	-------------	------------	-------------	-------------	-------------

Table 3. Performance of intelligent systems with pre-processing stage

Comparing Table 3 with Table 2, it is evident that the pre-processing stage is essential for the proper classification of the disturbances that affect the power quality. It is necessary to comment that the neural networks (with BP, LM and RPROP training algorithms), as well

as, the neural-genetic hybrid system use a MLP architecture with 15 neurons in the first hidden layer, 20 neurons in the second hidden layer and 1 neuron in the output layer. All hidden layers use a hyperbolic tangent as activation function and the output layer uses a linear activation function.

6. Conclusions

This chapter consisted in developing an alternative technique for signals pre-processing based on calculations of the fractal dimension, Shannon entropy and signal energy that enables the classification of disturbances occurring in electrical power distribution systems.

It is possible to highlight that the proposed methodology for pre-processing has provided a good data preparation for the disturbances classification stage, improving the convergence of the intelligent systems, which has consequently supplied satisfactory results for identifying disturbances associated with power quality.

It is important to say that this methodology has been developed carrying out certain data window of the signals that characterize the simulated events, where, for each window, the dimension of fractal, the Shannon entropy and the energy have been calculated. After this data pre-processing stage, intelligent systems are parameterized and the variables calculated in the pre-processing stage are provided as inputs.

The results show that the intelligent systems present better results with pre-processing stage. Therefore, the contribution of pre-processing tools for disturbances classification is evidenced here.

Thus, for future works the application of the methodology used in data pre-processing in different tasks of classification of disturbances should be used, such as to detect the saturation of the transformers, and other problems related to electrical power distributions systems.

7. References

- Addison, P. S. (2002). *The Illustrated Wavelet Transform Handbook – Introductory Theory and Applications in Science, Engineering, Medicine and Finance* (1st Ed.), Institute of Physics Publishing, ISBN: 0750306920, Philadelphia.
- Al-Akaidi, M. (2004). *Fractal Speech Processing* (1st Ed.), Cambridge University Press, ISBN: 0521814588, New York.
- Behera, H. S.; Dash, P. K. & Biswal, B. (2010). Power Quality Time Series Data Mining Using S-Transform and Fuzzy Expert System. *Applied Soft Computing*; Vol. 10, Oct. 2010, pp. 945-955, ISSN: 1568-4946.
- Daubechies, I. (1992). Ten Lectures on Wavelets. *CBMS-NSF Regional Conference Series in Applied Mathematics*, ISBN: 0898712742, Philadelphia.
- De Jong, K. A. (1975). An Analysis of the Behavior of a Class of Genetic Adaptative Systems. Ph.D. Thesis, University of Michigan, 1975.
- Dugan, R. C.; McGranaghan, M. F.; Santoso, S. & Beaty, H. W. (2003). *Electrical Power Systems Quality* (2nd Ed.), McGraw Hill, ISBN: 9780071386227, New York.
- EEUG (1987). Alternative Transients Program Rule Book. LEC.
- Goldberg, D. E. (1989). *Genetic Algorithms in Search, Optimization and Machine Learning*, Addison-Wesley Longman Publishing Co., Inc. Boston, MA, USA.

- Hagan, M. T. & Menhaj, M. B. (1994). Training Feedforward Networks with the Marquardt Algorithm. *IEEE Transactions on Neural Networks*; Vol. 5, No. 6, Nov. 1994, pp. 989-993, ISSN: 1045-9227.
- Haykin, S. (1999). *Neural Networks – A Comprehensive Foundation* (2nd ed.), Prentice Hall, ISBN: 0132733501, Ontario.
- Hooshmand, R. & Enshae, A. (2010). Detection and Classification of Single and Combined Power Quality Disturbances Using Fuzzy Systems Oriented by Particle Swarm Optimization Algorithm. *Electric Power Systems Research*; Vol. 80, Dec. 2010, pp. 1552-1561, ISSN: 0378-7796.
- Hu, G.; Zhu, F. & Zhang, Y. (2007). Power Quality Faint Disturbance Using Wavelet Packet Energy Entropy and Weighted Support Vector Machine. *3rd International Conference on Natural Computation (ICNC)*, ISBN: 0769528759, Haikou, Aug. 2007.
- Janik, P. & Lobos, T. (2006). Automated Classification of Power-Quality Disturbances Using SVM and RBF Networks. *IEEE Transactions on Power Delivery*; Vol. 21, No. 3, July. 2006, pp. 1663-1669, ISSN: 0885-8977.
- Jayasree, T.; Devaraj, D. & Sukanesh, R. (2010). Power Quality Disturbance Classification Using Hilbert Transform and RBF Networks. *Neurocomputing*; Vol. 73, Mar. 2010, pp. 1451-1456, ISSN: 0925-2312.
- Meher, S. K. & Pradhan, A. K. (2010). Fuzzy Classifiers for Power Quality Events Analysis. *Electric Power Systems Research*; Vol. 80, Jan. 2010, pp. 71-76, ISSN: 0378-7796.
- Moravej, Z.; Pazoki, M. & Abdoos, A. A. (2011). Wavelet Transform and Multi-Class Relevance Vector Machines Based Recognition and Classification of Power Quality Disturbances. *European Transactions on Electrical Power*; Vol. 21, Jan. 2011, pp. 212-222, ISSN: 1546-3109.
- Oleskovicz, M.; Cury, D. V.; Delmont Filho, O.; Usida, W. F.; Carneiro, A. A. F. M. & Pires, L. R. S. (2009). Power Quality Analysis Applying a Hybrid Methodology with Wavelet Transform and Neural Networks. *Electrical Power and Energy Systems*; Vol. 31, Jun. 2009, pp. 206-212, ISSN: 0142-0615.
- Riedmiller, M. & Braun, H. (1993). A Direct Adaptive Method for Faster Backpropagation Learning: The RPROP Algorithm. *Proc. of the IEEE International Conference on Neural Networks*, ISBN: 0780309995, San Francisco, Mar. 1993.
- Shannon, C. E. (1948). Mathematical Theory of Communication. *Bell System Technical Journal*; Vol. 27, Jun. and Oct. 1948, pp. 379-423 and pp. 623-656.
- Takagi, T. & Sugeno, M. (1985). Fuzzy Identification of Systems and Its Applications to Modeling and Control. *IEEE Transactions on System, Man, and Cybernetics*; Vol. 15, No. 1, Feb. 1985, pp. 116-132, ISSN: 00189472.
- Uyar, M.; Yildirim, S. & Gencoglu, M. T. (2008). An Effective Wavelet-Based Feature Extraction Method for Classification of Power Quality Disturbance Signals. *Electrical Power Systems Research*; Vol. 78, No. 10, Oct. 2008, pp. 1747-1755, ISSN: 0378-7796.
- Walker, J. S. (1999). *A Primer on Wavelets and Their Scientific Applications*, Chapman & Hall (CRC), ISBN: 0849382769, Washington.
- Zadeh, L. A. (1965). Fuzzy Sets. *Information and Control*; Vol. 8, No. 3, Jun. 1965, pp. 338-353, ISSN: 0019-9958.
- Zadeh, L. A. (1996). Fuzzy Logic = Computing with Words; *IEEE Transactions on Fuzzy Systems*, Vol. 4, No. 2, May 1996, pp. 103-111, ISSN: 1063-6706.

- Zhang, M.; Li, K. & Hu, Y. (2011). A Real-Time Classification Method of Power Quality Disturbances. *Electric Power Systems Research*; Vol. 81, Feb. 2011, pp. 660-666, ISSN: 0378-7796.
- Zhu, T. X.; Tso, S. K. & Lo, L. K. (2004). Wavelet-Based Fuzzy Reasoning Approach to Power-Quality Disturbance Recognition. *IEEE Transactions on Power Delivery*; Vol. 19, No. 4, Oct. 2004, pp. 1928-1935, ISSN: 0885-8977.

IntechOpen

IntechOpen

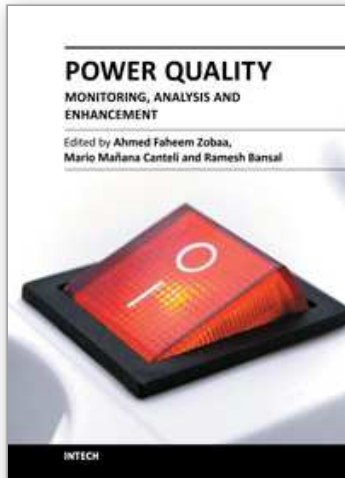

Power Quality “ Monitoring, Analysis and Enhancement

Edited by Dr. Ahmed Zobaa

ISBN 978-953-307-330-9

Hard cover, 364 pages

Publisher InTech

Published online 22, September, 2011

Published in print edition September, 2011

This book on power quality written by experts from industries and academics from various countries will be of great benefit to professionals, engineers and researchers. This book covers various aspects of power quality monitoring, analysis and power quality enhancement in transmission and distribution systems. Some of the key features of books are as follows: Wavelet and PCA to Power Quality Disturbance Classification applying a RBF Network; Power Quality Monitoring in a System with Distributed and Renewable Energy Sources; Signal Processing Application of Power Quality Monitoring; Pre-processing Tools and Intelligent Techniques for Power Quality Analysis; Single-Point Methods for Location of Distortion, Unbalance, Voltage Fluctuation and Dips Sources in a Power System; S-transform Based Novel Indices for Power Quality Disturbances; Load Balancing in a Three-Phase Network by Reactive Power Compensation; Compensation of Reactive Power and Sag Voltage using Superconducting Magnetic Energy Storage; Optimal Location and Control of Flexible Three Phase Shunt FACTS to Enhance Power Quality in Unbalanced Electrical Network; Performance of Modification of a Three Phase Dynamic Voltage Restorer (DVR) for Voltage Quality Improvement in Distribution System; Voltage Sag Mitigation by Network Reconfiguration; Intelligent Techniques for Power Quality Enhancement in Distribution Systems.

How to reference

In order to correctly reference this scholarly work, feel free to copy and paste the following:

Ricardo A. S. Fernandes, Ricardo A. L. Rabêlo, Daniel Barbosa, Mário Oleskovicz and Ivan Nunes da Silva (2011). Pre-Processing Tools and Intelligent Systems Applied to Power Quality Analysis, Power Quality “ Monitoring, Analysis and Enhancement, Dr. Ahmed Zobaa (Ed.), ISBN: 978-953-307-330-9, InTech, Available from: <http://www.intechopen.com/books/power-quality-monitoring-analysis-and-enhancement/pre-processing-tools-and-intelligent-systems-applied-to-power-quality-analysis>

INTECH
open science | open minds

InTech Europe

University Campus STeP Ri
Slavka Krautzeka 83/A
51000 Rijeka, Croatia
Phone: +385 (51) 770 447
Fax: +385 (51) 686 166

InTech China

Unit 405, Office Block, Hotel Equatorial Shanghai
No.65, Yan An Road (West), Shanghai, 200040, China
中国上海市延安西路65号上海国际贵都大饭店办公楼405单元
Phone: +86-21-62489820
Fax: +86-21-62489821

www.intechopen.com

www.intechopen.com

IntechOpen

IntechOpen

© 2011 The Author(s). Licensee IntechOpen. This chapter is distributed under the terms of the [Creative Commons Attribution-NonCommercial-ShareAlike-3.0 License](https://creativecommons.org/licenses/by-nc-sa/3.0/), which permits use, distribution and reproduction for non-commercial purposes, provided the original is properly cited and derivative works building on this content are distributed under the same license.

IntechOpen

IntechOpen