

We are IntechOpen, the world's leading publisher of Open Access books Built by scientists, for scientists

5,300

Open access books available

129,000

International authors and editors

155M

Downloads

Our authors are among the

154

Countries delivered to

TOP 1%

most cited scientists

12.2%

Contributors from top 500 universities



WEB OF SCIENCE™

Selection of our books indexed in the Book Citation Index
in Web of Science™ Core Collection (BKCI)

Interested in publishing with us?
Contact book.department@intechopen.com

Numbers displayed above are based on latest data collected.
For more information visit www.intechopen.com



Applications and Optoelectronic Methods of Detection of Ammonia

Paul Chambers, William B. Lyons, Tong Sun and Kenneth T.V. Grattan
*City University, London
United Kingdom*

1. Introduction

This chapter describes applications of ammonia in agriculture, pharmaceutical and environmental industries and optoelectronic methods of its detection.

In Section 2 the discovery, the chemical structure, reactivity and application of ammonia are reviewed. Applications in agriculture, cleaning products, pharmaceutical industries, beauty products, the benefits and dangers of ammonia to human health, environment and industrial processes are also discussed.

Section 3 describes the rotational-vibrational molecular processes that cause the optical absorption of light in the infrared spectrum. The infrared and ultraviolet absorption spectra are also shown. Data relating to the absorption of light by ammonia at ultraviolet wavelengths is also shown.

Existing optical ammonia gas detection methods that utilise lasers and broadband sources and the evanescent field of an optical fibre are described in Section 4. This includes a discussion of optical sources, optical fibers, gas cell designs and detectors that are used in optoelectronic gas sensing systems.

In section 5, the limiting effects of fundamental noise sources, such as photon noise, resistor noise and optical source noise on sensor sensitivity are described. The selective performance of optoelectronic gas sensors is also discussed, i.e. the discrimination of the sensor to different gases.

2. Ammonia: the chemical

The ammonia molecule consists of one nitrogen atom covalently bound to three hydrogen atoms, the pyramidal configuration is shown in Figure 1. The structure of the covalent bond results in the compound being neutral in charge, but there remain two unfilled electron pairs in the valence band. As ammonia has an unfilled valence band, it is a weak base, with a pH of approximately 12. Ammonia exists in the gas phase in the environment, as the boiling point of ammonia is $-33.35^{\circ}C$.

The production of ammonia by the distillation of animal hoofs, horns and hide scraps is recognised as a very old method of the extraction of ammonia. Written references to the use of ammonia date back to the thirteenth century in Catalan literature (Miller (1981)), while Felty (1982) noted that the name ammonia is derived from the salt sal-ammoniac. Sal-ammoniac (salt comprised of ammonium chloride) or salt of Ammon was named after the Egyptian chief

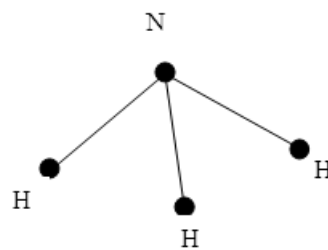

Fig. 1. Diagram of ammonia molecule consisting of 1 nitrogen and 3 hydrogen atoms which are covalently bound.

God Ammon, as it is possible that it was extracted from camel dung near the Temple of Jupiter, in ancient Egypt (in present day Libya) in around 332 B.C..

In Miller (1981), it is also described how Johann Kunkel van Lowenstern noticed that ammonia gas could be produced by the addition of lime to sal-ammoniac. In 1773 Joseph Priestley was the first chemist to identify and extract pure gaseous ammonia by applying heat to aqueous ammonia mixed with sal-ammoniac. Using the Haber-Bosch process of nitrogen fixation (Howard & Rees (1996)), ammonia is now the most widely synthetically produced chemical. Ammonia reacts with acids or neutral substances, such as water, sulfuric acid and nitric acid. These reactions result in the formation of anhydrous ammonia, which is acidic, ammonium sulfate and ammonium nitrate. Compounds in the Amine functional group are derived from the ammonia molecule, where one, or more, of the hydrogen atoms is replaced with an alternate chemical arrangement.

Ammonia currently has a wide range of uses and applications. When used in agriculture, ammonia forms a source of nitrides in fertilisers which promotes plant growth. In cleaning products the action of ammonia hydroxide, as an acid, aids in removing contamination from surfaces. In hair conditioners, ammonia aids the blending of colour into hair. Pharmaceutical processes use ammonia as a buffer to control the P.H. level for solution preparation. Dissociated ammonia atmospheres are employed in steel processing for the annealing of steel to aid corrosion resistance (Levey & van Bennekom (1995), Samide et al. (2004)). Chilled ammonia is used, as a binding agent, to remove carbon dioxide from the exhausts from fossil fuel burning power plants (Darde et al. (2008)).

While ammonia gas is necessary for these processes, it is dangerous to people in excessive concentrations if inhaled, as anhydrous ammonia is corrosive (Close et al. (1980)). Ammonia is also destructive when present in semiconductor fabrication facilities (Sun et al. (2003)). For safety reasons and process monitoring applications, it is therefore important to monitor the concentrations of ammonia and optoelectronic methods can provide an accurate means of achieving this.

3. Optical absorption spectrum of ammonia

The literature relating to the vibrational and electronic optical absorption spectra is reviewed in this section. This includes data relating to the infrared and ultraviolet absorption spectra.

3.1 Infrared absorption spectrum

Incident optical radiation on the ammonia molecule causes vibrations of the inter-atomic distances between the nitrogen and hydrogen atoms in the pyramidal structure. This causes

the partial absorption of optical power at characteristic wavelengths, including the original vibration and higher frequency (shorter wave-length) harmonics, resulting in the absorption spectrum. The rotational-vibrational modes, as reviewed by McBride & Nicholls (1972) are shown in Figure 2. The non-degenerate symmetric ν_1 and ν_2 vibrational modes shown in Figures 2(a) and 2(b), preserve the pyramidal shape, while the degenerate ν_3 and ν_4 modes, shown in figures 2(c) and 2(d) distort the three dimensional shape.

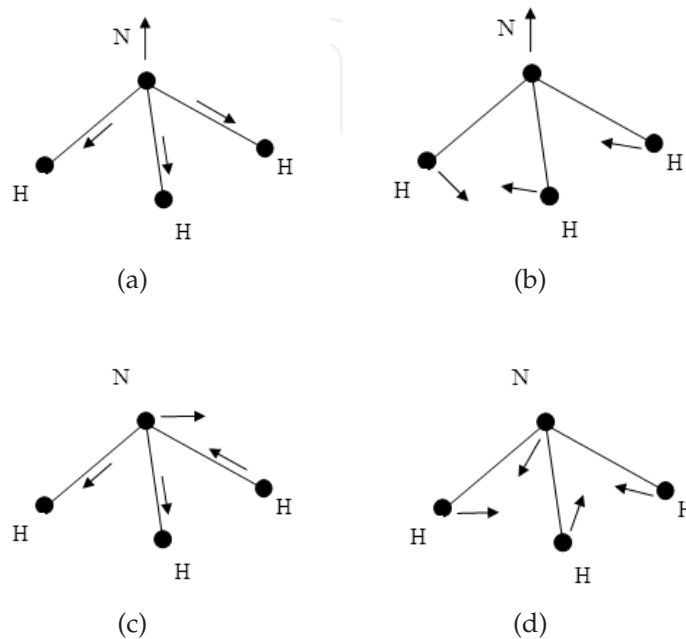

Fig. 2. The rotational-vibrational modes of the ammonia (NH_3) molecule

- (a): ν_1 vibration
- (b): ν_2 vibration
- (c): ν_3 vibration
- (d): ν_4 vibration

The optical absorbance of a gas is defined in terms of its cross-section. The absorbance cross-section is denoted by $\sigma(\lambda)$. The Beer-Lambert Law, which is shown in Equation 1, describes the relationship between the incident optical power, I_0 , and the transmitted power intensity, I_1 , at each wavelength, λ , in terms of the absorbance cross-section, $\sigma(\lambda)$, gas path-length, l , and gas concentration, c .

$$\ln \left(\frac{I_0}{I_1} \right) = \sigma(\lambda) \times l \times c \quad (1)$$

The cross-sections of atmospheric gases are contained in the HITRAN database. While the database is updated, with the last update in 2008 (<http://www.hitran.com>), the last update of the ammonia gas data was in the 1986 edition (Rothman et al. (1987)). The articles documenting the molecular vibrations of ammonia and their characteristic wave-lengths are detailed in Table 1.

The cross-sectional absorbance spectrum up to $8\mu\text{ m}$ using data from the Hitran database, which was detailed in Table 1, is shown in Figure 3. It can be observed that the maximum

Wavelength	Absorption Band	Reference
1.89–2.09 μm	$\nu_1 + \nu_4$ $\nu_3 + \nu_4$	Brown & Margolis (1996)
6.00 μm	$2\nu_2 / \nu_4$	Cottaz et al. (2000)
5–8 μm	$3\nu_2 - \nu_2$ $\nu_2 + \nu_4 - \nu_2$	Cottaz et al. (2001)
4.00 μm	$4\nu_2 - \nu_2$ $\nu_1 - \nu_2$ $\nu_3 - \nu_2$	
3 μm	ν_1 ν_3 $2\nu_4$	Kleiner et al. (1999) Guelachvili et al. (1989)
4 μm	$3\nu_2 / \nu_2 + \nu_4$	Kleiner et al. (1995)
1.89–2.09 μm	$\nu_1 + \nu_2$ $\nu_2 + \nu_3$ $\nu_2 + 2\nu_4$	Urban et al. (1989)

Table 1. The rotational-vibrational coupling of ammonia gas that gives the infra-red absorption of ammonia gas

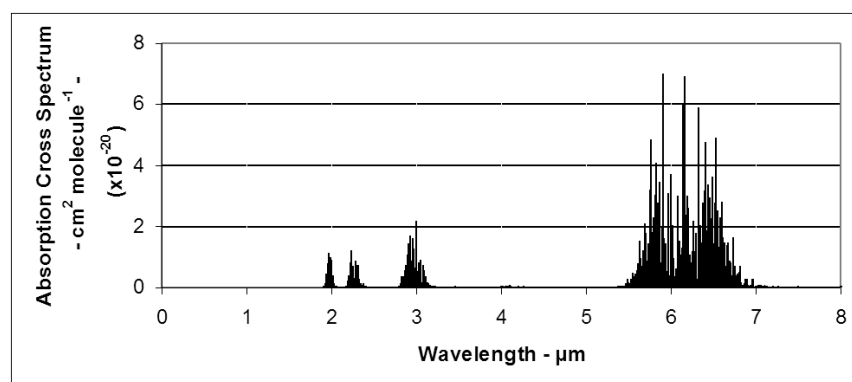

Fig. 3. The infrared absorption cross-section of ammonia gas. The data were selected from the 1986 edition of the HITRAN database (Rothman et al. (1987)), which includes the data described in Table 1

cross-section absorbance in this wavelength range is approximately $7 \times 10^{-20} \text{ cm}^2 \text{ molecule}^{-1}$ at around 6 μm .

3.2 Ultraviolet absorption spectrum

Ammonia also absorbs optical power at ultraviolet wavelengths. The ultraviolet electronic absorption is caused by the interaction of light with electrons in the valence band of the ammonia molecule (Burton et al. (1993)). The absorption spectrum of ammonia is shown in Figure 4. The data was obtained from the results of Cheng et al. (2006) that are contained in the Mainz UV spectral database (Keller-Rudek & Moortgat (2006)).

The peak absorbance shown in Figure 4 in the ultraviolet absorption spectrum is approximately $2 \times 10^{-17} \text{ cm}^2 \text{ molecule}^{-1}$. This is around one thousand times greater than was the case in the

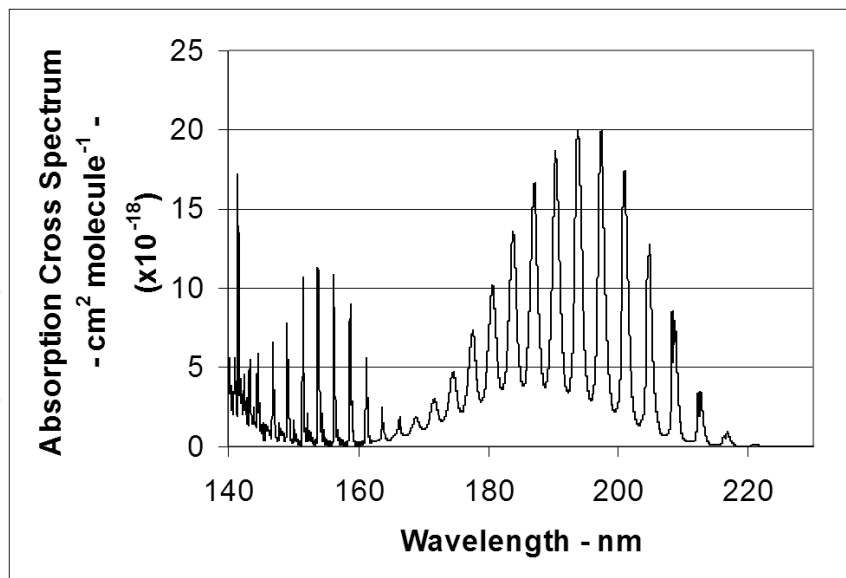

Fig. 4. Ultraviolet absorption cross-section absorption spectrum of NH_3 . Absorption spectrum data shown were taken from Cheng et al. (2006)

infrared spectrum. As the absorbance cross section is in the exponent of Equation 1, this leads to a difference in the gas absorption of many orders of magnitude.

4. Optical methods of detection

This Section reviews a range of optoelectronic methods for the detection of gases including how they are applied for the detection of ammonia.

Early optical gas analysers relied upon the photoacoustic properties of gases, at the time this was referred to as the "Tyndall-Röntgen effect". The "Tyndall-Röntgen effect" in gases is analogous to the "Bell effect", which is the development of an audible sound arising from the intermittent exposure of a solid or liquid to radiation. Early gas sensing systems that utilised the photoacoustic effect were developed before, during and since World War II, in Britain, the U.S.S.R. and Germany. An example of an early gas detection method due to Veingerov (1938), which is described in Hill Hill & Powell (1968), is shown in Figure 5. The gas analyser, which was named an "optico-acoustic" analyser, operated by passing intensity modulated optical radiation from a Nernst Glower Source through a highly polished tube to a telephone receiver. The pressure variations induced by the intermittent optical beams resulted in a differing expansion of the gases present in the sample gas cell. This, in turn, induced the generation of acoustic tones that were picked up by the telephone earpiece (microphone). These tones were indicative of the gases present in the sample gas cell. The branch-resonator enabled the pressure fluctuations developed to be amplified, so that the detected signal could be enhanced.

Concurrently with the work by Veingerov, Luft developed a null-balance arrangement (see Hill & Powell (1968)). This, and systems developed from it, were later referred to as LIRA (Luft Infra-Red Analyser, Luft (1947)) type analysers, an example of which is shown in Figure 6.

The systems operate by passing two alternately chopped optical beams through a reference gas cell and a sample or measurement gas cell to a detector. Initially the device was

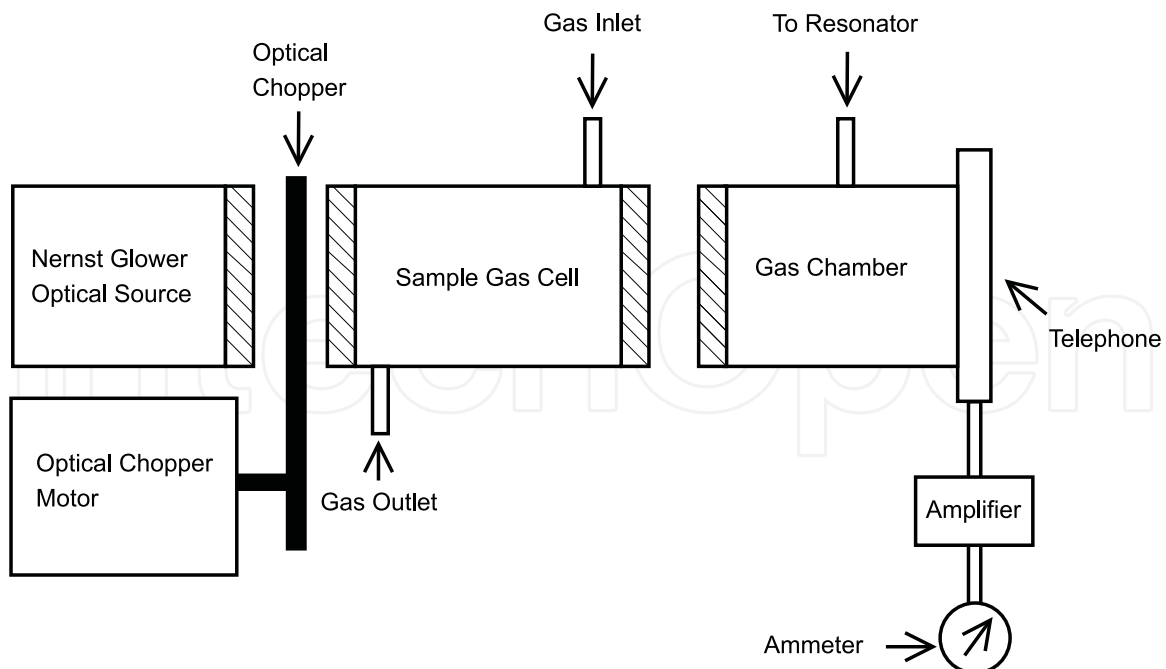

Fig. 5. An early "optico-acoustic" gas detection arrangement due to Vengerov (see references Hill & Powell (1968); Veingerov (1938))

"null-balanced" by filling both the reference and sample cells with a gas that had no absorption lines in the spectrum of interest and equalising the intensity of the optical beams by adjusting a blocking trimmer screw. The insertion of the sample gas into the sample or measurement cell leads to a signal modulation at the detector which is proportional to the target gas concentration in the sample gas. It was found that, by the insertion of a reference gas cell in series with the measurement gas cell, the selectivity of the system to the target gas could be improved. The LIRA system was able to detect CO_2 concentrations of less than 10 ppm (parts per million).

Hill & Powell (1968) also described the development of early gas analysers that were manufactured during the 1950s and 1960s and the development of early infra-red detectors. Goody (1968) explored the possibility of selectively detecting a specified target gas by a correlation technique. Goody introduced a pressure modulated "cross-correlating spectrometer", a device which involved passing light from an optical source through two sequential gas cells and an optical filter, before impinging on an optical detector, see Figure 7. The first gas cell contained the gas volume to be analysed (the measurement cell) and the second contained only the target gas (the reference cell). By modulation of the target gas pressure within the reference gas cell, a modulation of the detected optical power at the output of the measurement gas cell was observed. This magnitude of the output modulation was related to the concentration of target gas within the measurement gas cell. The method showed high rejection of drifts in source power and had high rejection of contaminant gas. A NH_3 sensor based on this method was found to be 140 times less sensitive to N_2O contaminant gas, even though the spectral absorption of N_2O is significantly stronger than the spectral absorption of NH_3 in the band used.

Taylor et al. (1972) provide details of a similar system, intended to measure remotely (from a satellite) the temperature of the upper atmosphere from the spectral transmission of CO_2 . The system gathered light reflected from the earth's atmosphere, and passed it through a pressure

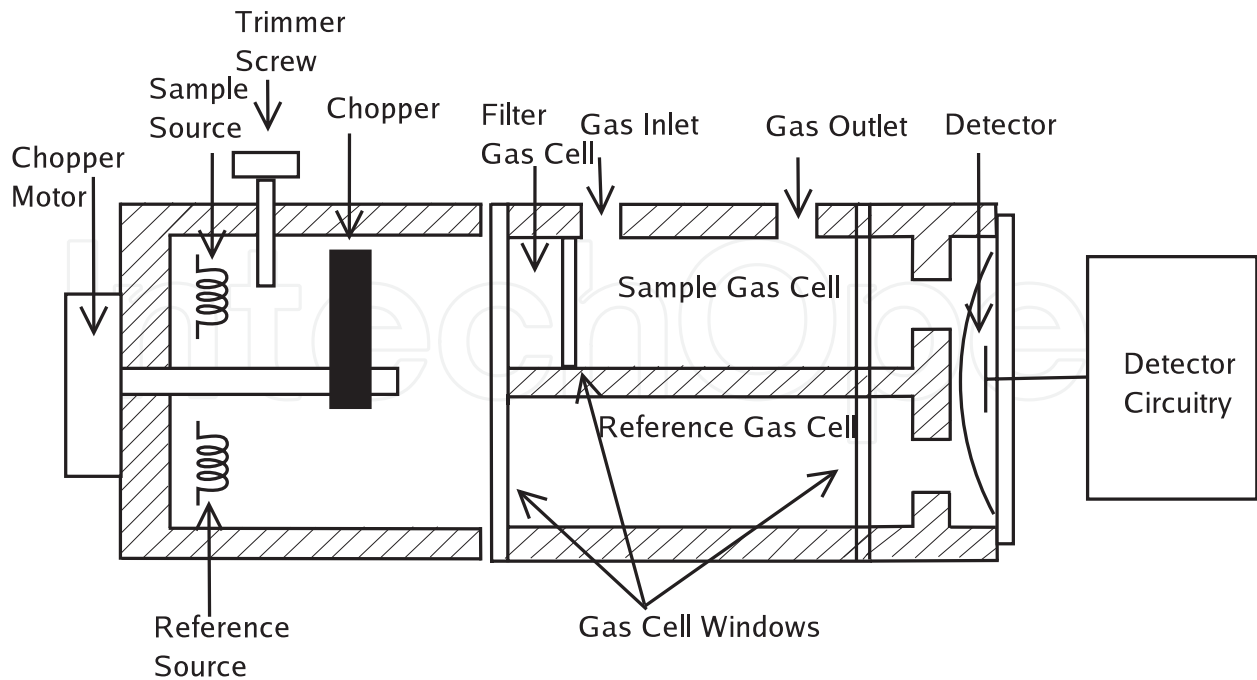

Fig. 6. A Null-Balance Lira (Luft Infra-Red Gas Analyser) gas detection system Hill & Powell (1968)

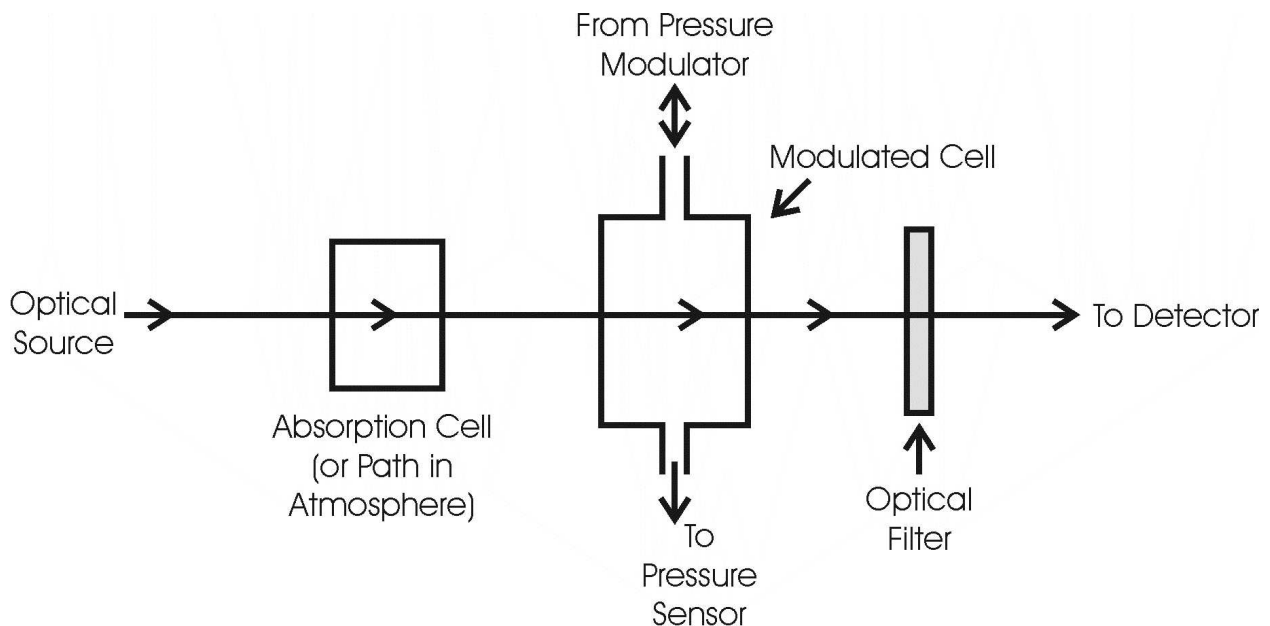

Fig. 7. Pressure Modulation Spectroscopy system (reproduced from Goody Goody (1968))

modulated reference gas cell to a detector. Their system showed a sensitivity of 1°C . This method utilised the spectral emission of CO_2 at $15\ \mu\text{m}$.

A reported method of modulating the transmission of the reference cell was that of Stark modulation. This is the line-splitting effect that results when a high electric field is applied to a gas. It is only effective on molecules having a significant dipole moment, e.g. H_2O , CH_4 etc. Edwards & Dakin (1993) investigated the use of Stark modulation for the detection of ammonia and water vapour, both of industrial significance, using optical fibre-based systems.

This system demonstrated the use of optical fibres for gas detection, an area which is now discussed in detail.

4.1 Optical fibre implementations

Optical detection systems using optical fibres offer a number of advantages over bulk optical sensing systems. This section develops the review by Dakin and Chambers (2004) to show the application of sensors using an optical fibre for the detection of ammonia. The principal advantage is that a robust passive sensing head may be sited remotely from the monitoring station, which is a useful feature in severe environments. This also allows for the development of multiplexed networked systems, where a single interrogation unit can monitor many low-cost passive sensing heads via a predictable propagation medium (i.e. the optical fibre). Conventional silica fibres have the disadvantage that transmission is restricted to the visible and near-infra-red region (0.6 μm to 2.0 μm). Fluoride and other fibres may be used to extend the operation of these sensors further into the infra-red, allowing accurate detection of gases with infra-red absorption in the mid- and far-infra-red. Unfortunately, these fibres are expensive and less robust. Optical fibre sensors are also generally believed to be safe for use in explosive atmospheres. However, the safety of optical fibre sensors is not unqualified, as it has been established that in the case of very high powers, i.e. of the order of 100 mW, or greater in multi-mode fibre, explosive risks may present themselves (Hills et al. (1993); Zhang et al. (1992)). Conventional optical fibres have a very small acceptance aperture, which severely restricts the amount of light that can be coupled into a fibre. Thus the power launched into optical fibres from high-radiance near-infra-red (NIR, $\sim 0.7 \mu\text{m}$ – $\sim 1.5 \mu\text{m}$) Light Emitting Diodes (LEDs) is rarely above 1mW, even when large core optical fibres are used, and by comparison the spectral radiance of incandescent filament lamps is usually at least an order of magnitude less. Longer wavelength LEDs ($> \sim 1.5 \mu\text{m}$) often have a lower spectral radiance. As the launched power is relatively low, sensitive light detection systems are required to produce operational sensors. With laser sources, there is no difficulty in achieving launch efficiencies in excess of 80% into multi-mode fibres. Consequently high powers can be launched, and the detection system constraints are eased substantially.

It was realised that narrow-linewidth diode lasers could readily be used in fibre-optic environmental detection systems. Inaba et al. (1979) suggested the use of a dual-wavelength laser to realise a differential absorption method that could be used over many kilometres of low-loss optical fibre in cases where it was necessary to locate the sensing head remotely from the measuring equipment. This typically involved the comparison of the received powers at two, or more, different wavelengths, each having passed through a remote measurement gas cell, so that the differential absorption of the two wavelengths by the gas sample could be used to infer the concentration of the target gas. The method required that the target gas possessed suitable gas absorption bands within the spectral transmission window of the optical fibre.

Culshaw et al. (1998) have surveyed some of the system topologies that may be used with laser-based optical gas detection systems and quantified the expected system sensitivities, which are of the order of less than 1 ppm. Stewart et al. (2004) and Whitenett et al. (2004) have realised some of these topologies, which included a Distributed FeedBack (DFB) wavelength modulated laser cavity ring-down approach that showed a methane detection sensitivity of 50 ppm.

A laser-based detection system for the detection of NO_2 gas (which is an industrial hazard and common environmental pollutant) was developed by Kobayashi et al. (1981). This was

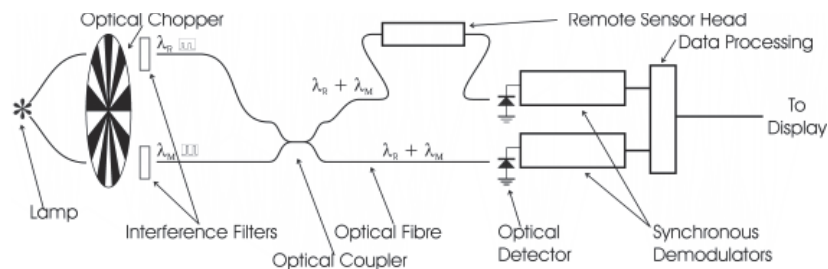

Fig. 8. Schematic of a differential fibre-optic detection system (redrawn from a diagram in Hordvik et al. (1983)).

achieved by splitting light, from an Ar-ion multi-line laser, into two paths, one passing through a measurement gas, and the other being transmitted directly to the measurement unit as a reference signal. The detection unit contained two filters to separate the two chosen laser lines, and these were then detected on separate optical receivers. One of these chosen laser lines coincided with a strong absorption line in the NO_2 absorption spectrum, whilst the other absorption line was somewhat weaker, hence giving a differential absorption method, by which the concentration of NO_2 in the measurement cell could be found. The system had an estimated detection limit of 17 ppm. The advantages of this dual-wavelength system were that the measurement was dependent on neither the optical power spectrum from a single source, which could drift, nor the system transmission, which could be affected by optical alignment, surface contamination, etc. It was realised that the selection of light sources used in this type of detection system was not necessarily limited to lasers, but broad-band sources such as filtered incandescent lamps or LEDs could also be used.

Hordvik et al. (1983) developed a fibre-optic system for the remote detection of methane gas (CH_4), see Figure 8. This system used a halogen lamp light source, which was alternately chopped into two separately filtered paths. One path was passed through a narrow-band interference filter, centred at the same wavelength as a strong absorption band of CH_4 (Q-branch centred at $1.666 \mu\text{m}$), whilst the other filter covered a broader spectral range, and consequently had lower average absorption. These two complementary-modulated beams were combined by means of a fibre-coupler, with two output ports. Light from one was passed through a measurement cell to an optical detector (the measurement signal), and light from the other was passed directly to an optical detector (reference signal). By comparison of the optical powers in the narrow-band and broadband beams of the light that had and had not passed through the measurement cell, it was possible to calculate the CH_4 concentration.

A somewhat similar system based on the use of optical fibres and optical fibre couplers, but with the innovative use of compact LED light sources, was developed by Stueflotten et al. (1982). The schematic of the system is shown in Figure 9. Again, two different optical filter wavelengths were used, to give differential attenuation in strong and weak gas absorption regions. This was proposed for remote measurement in hazardous industrial environments, such as off-shore oil platforms. The systems above developed by Hordvik and Stueflotten both had a reported detection limit of approximately 5000 ppm (0.5% vol/vol) of methane.

4.2 Sensing using inelastic processes

Other forms of spectrophotometric processes rely on Raman scattering. A Raman scattering gas detection method is now briefly reviewed.

Raman scattering involves the inelastic scattering of light, i.e. first absorption and then delayed re-emission of light at a different wavelength to that incident on the material. The Raman process represents a form of scattering in which an incident photon may gain energy from (the anti-Stokes Raman process), or donate energy to (the Stokes Raman process) a vibrational or rotational energy level in a material. This produces a re-emitted photon of different energy and, hence, of a different wavelength. A method of detection that exploits Raman spectroscopy was developed by Samson & Stuart (1989) using the detection system shown in Figure 10. Raman scattering in gases is generally very weak, but the emission usually occurs in a well defined spectrum.

In the system developed by Samson and Stuart, the laser excites the gas and a mirror is used to reflect the incident light back through the interaction zone. Another concave mirror reflector doubles the level of Raman light received by the collection lenses. The alternative inelastic scattering process of fluorescence is rare in gases, and consequently is not commonly used for optical gas sensors, but fluorescence cannot be ignored when using Raman sensing, as it can cause crosstalk if it occurs in optical glass components or at mirror surfaces. Fortunately, Raman lines for simple gases are narrow compared to fluorescence emission which is usually relatively broadband. Raman detection systems may be employed to monitor the concentration of ammonia and ammonia based compounds in industrial atmospheres (Schmidt et al. (1999)).

4.3 Comb filter modulator for partially matching several spectral lines

Instead of detecting a gas using a single line of its absorption spectrum, or using a broadband source to cover many absorption lines, there are advantages in using some form of optical “comb” filter, with several periodic narrow transmission windows, in order to match several

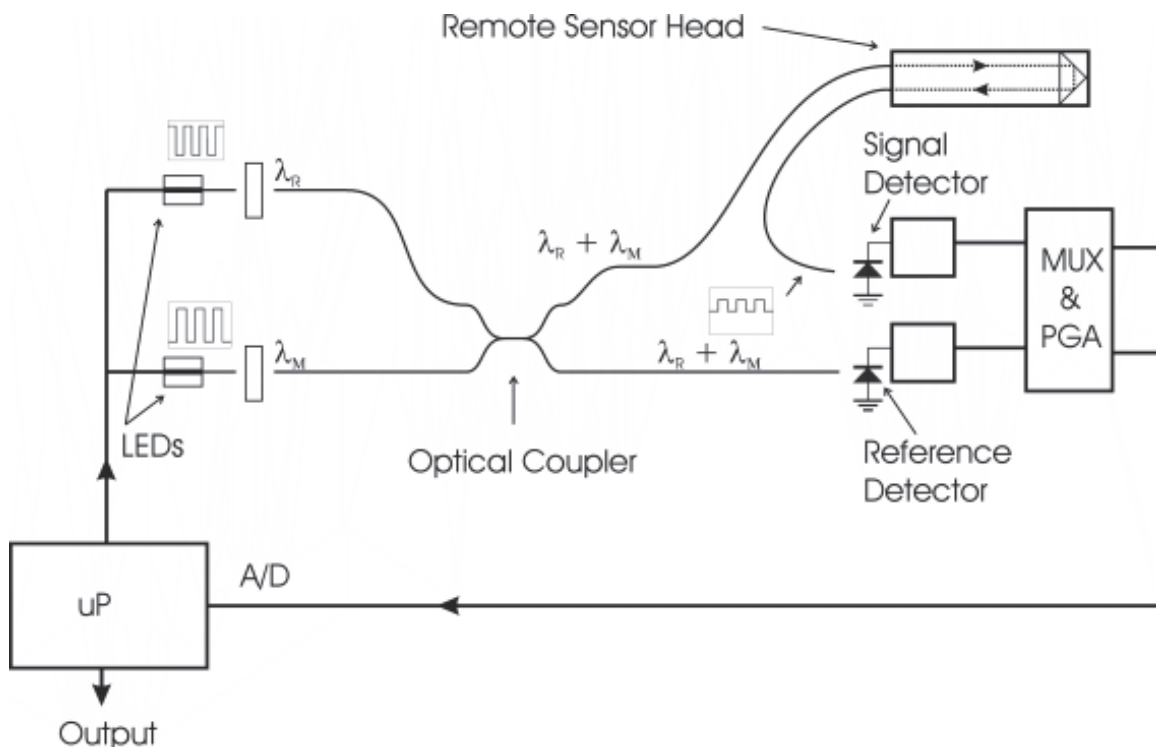

Fig. 9. Schematic of the differential fibre-optic detection system (redrawn from a diagram of Stueflotten et al. (1982))

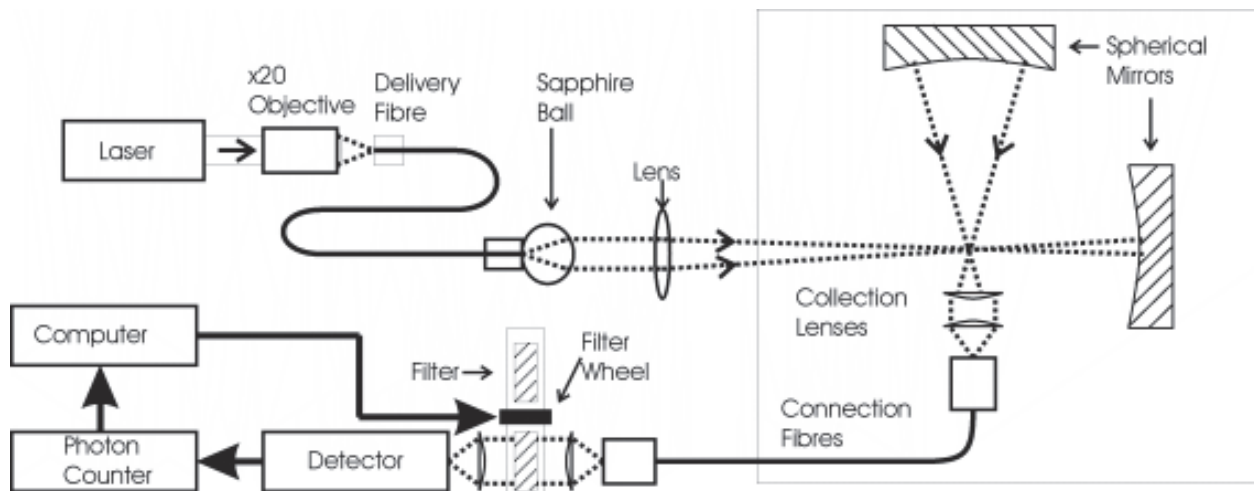

Fig. 10. Schematic of a gas sensor using Raman Scattering (Redrawn from Samson & Stuart (1989))

spectral lines simultaneously. Such a comb filter can be scanned, correlated or wavelength modulated, through a set of gas lines to give an intensity modulation. The method has the advantage that it may allow improved selectivity, as a synthetic multiple-narrow-line comb-filter spectrum allows simultaneous measurement on several spectral lines. This reduces interference effects, which can cause complications with laser sources. A method of doing this, with a scanned Fabry-Perot comb filter, has been demonstrated (Dakin *et al.* (1987); Mohebati & King (1988)) with application to methane detection. Dakin *et al.* implemented a system that passed light sequentially from a source through a Fabry-Perot interferometer to a detector. By changing the spacing of the plates of the interferometer the transmission of fringes of the interferometer were tuned to match the absorption spectrum of the methane target gas. Dakin *et al.* (1987) reported a sensitivity limit of 100 ppm. The disadvantage of the Fabry-Perot filter is that it has a regular frequency spacing, whereas the gas absorption features are not normally equally spaced. A variation of the method is to use the correlation spectroscopy complementary source modulation technique with a filter that replicates the gas transmission spectrum. Recently in Vargas-Rodriguez & Rutt (2009) have demonstrated that, using this approach at $3.3 \mu\text{m}$, a minimum detection level of 0.023 % methane could be detected with a 1 s integration time.

4.4 Photoacoustic ammonia gas detection

A wavelength modulation can also be used for a photo-acoustic optoelectronic gas concentration measurement. Kosterev & Tittel (2004) demonstrated a noise limited detection of 0.65 ppm v. The system operated by the wavelength modulation of light from a $1.53 \mu\text{m}$ laser source with a quartz tuning fork. The tuning fork vibration frequency was twice that of the modulation of the laser source. The detected current from the optical detector could then be demodulated to find the gas concentration.

4.5 Sol-gel ammonia detection

Gases, including ammonia, may also be detected by the application of a chemical indicator dye to the surface of an optical fibre. The Sol-gel process enables the deposition and immobilisation of the chemical dye on to the surface of the optical fibre. The dye then absorbs

light when in the presence of the gas to be sensed. The process can be applied to a wide range of chemical processes, however, the interactions of the dye with contaminant gases and humidity must be carefully considered (Malins et al. (1999)).

4.6 Ultraviolet optical detection of ammonia

The relatively intense ultraviolet absorption spectrum of ammonia, which was shown in Section 3.2, enables precise and selective detection of ammonia gas. Chambers et al. (2007) have demonstrated that ammonia gas can be detected at levels of ppm with low-cost ultraviolet LED light sources and detectors. Manap et al. (2009) has shown that the ultraviolet measurement was highly selective as contamination gases were not identifiable. With the recent development of these systems, it is necessary that the performance ultraviolet optical components are analysed (Eckhardt et al. (2007)).

5. Sources of noise

The accuracy of an optoelectronic sensor is limited by the selectivity and sensitivity of the sensor. These design considerations are now discussed.

In the design of optoelectronic gas sensor, it is important that the sensor measures solely the target gas that it was designed to measure. This is termed the selectivity of the sensor. In a gas absorption sensor selectivity issues can arise from contaminant gases, or the fouling of optical components, with an absorption spectrum that overlaps the gas to be sensed in the wavelength range of the optical source. Usually, the careful design of a sensor can eliminate this issue.

The measurement of an optoelectronic system will always be limited by a form of fundamental noise. These noise sources include resistor noise, photon noise, source noise and, in photo-acoustic systems, acoustic noise. Optical noise sources will now be discussed with their impact on measurement.

With optical absorption gas sensors it is necessary to accurately measure the optical power transmitted from the measurement gas cell. The output from the measurement detector photodiode is an electrical current that is proportional to the incident optical intensity. When broadband optical sources are used, the transmitted spectral power density is usually small, of the order of nW nm^{-1} , making it necessary to use a transimpedance amplifier to transform the detector current into a measurable voltage. This makes it necessary to use a sizeable feedback resistor, which is a significant source of thermal noise. This is usually the dominant source of noise in sensors with a low output optical power level. The thermal voltage noise, $V_{thermal}$, using the thermal noise equation is given by:

$$V_{thermal} = \sqrt{4kTR_{SO}B}, \quad (2)$$

where k is Boltzmann's constant, T is the resistor absolute temperature in kelvins, R_{SO} is the parallel resistance of the photodiode shunt resistance and feedback resistance and B is the post-detection noise bandwidth.

Shot noise (photon noise) describes the random arrival of photons at a detector and is described by Poisson Statistics. Photon noise is expressed by the following equation:

$$I_{Shot\ Noise} = \sqrt{2qI_{Sig}B},$$

where q is the electronic charge, I_{Sig} is the photocurrent generated and B is the post-detection noise bandwidth. With a shot noise limited system has reached the fundamental noise floor. The noise from an optical source is due to source related intensity or phase fluctuations. These variations have been analytically quantified and described by Tur et al. (1990). They derived a method for calculating the relative intensity noise from an optical source.

$$S_{in}(f) = \frac{0.66I_0^2}{\Delta\nu} \quad (3)$$

Tur et al. (1990) showed that the optical source noise may be described by Equation 3, where $\Delta\nu$ is the FWHM bandwidth (in Hertz) of the emission from the source, and the optical power from the source is I_0 . Source noise tends to be the dominant source of noise in laser coupled gas detection systems.

6. Conclusions

As the globally most produced chemical, with a range of applications in agriculture, cleaning products, pharmaceutical industry, steel processing and carbon dioxide capture processes ammonia is vitally important to modern life. The monitoring of ammonia concentration is essential as, not least the gas has a pungent odour, but is also extremely toxic.

The infrared and ultraviolet molecular absorption mechanisms were discussed and their resulting spectra shown. A range of optoelectronic detection systems were described. The intention is to show how these sensors may be adapted to domestic, agricultural and industrial environments. With the growing awareness of the importance and dangers of ammonia, it is highly likely that optoelectronic sensors will be further researched and developed.

7. References

- Brown, L. R. & Margolis, J. S. (1996). Empirical line parameters of NH_3 from 4791 to 5294 cm^{-1} , *JQSRT* 56: 283–294.
- Burton, G. R., Chan, W. F., Cooper, G. & Brion, C. E. (1993). The electronic absorption spectrum of nh_3 in the valence shell discrete and continuum regions. absolute oscillator strengths for photoabsorption (5–200 eV), *Chem. Phys.* 177: 217–231.
- Chambers, P., Lyons, W. B., Lewis, E., Sun, T. & Grattan, K. T. V. (2007). The potential for development of an NH_3 optical fibre gas sensor, *Journal of Physics: Conference Series, Third International Conference on Optical and Laser Diagnostics*, Vol. 012015.
- Cheng, B.-M., Lu, H.-C., Chen, H.-K., Bahou, M., Lee, Y.-P., Mebel, A. M., Lee, L. C., Liang, M.-C. & Yung, Y. L. (2006). Absorption cross sections of nh_3 , nh_2d , nhd_2 , and nd_3 in the spectral range 140–220 nm and implications for planetary isotopic fractionation, *The Astrophysical Journal* 647(2): 1535.
- Close, L. G., Catlin, F. I. & Cohn, A. M. (1980). Acute and chronic effects of ammonia burns of the respiratory tract, *Arch Otolaryngol.* 106(3): 151–158.
- Cottaz, C., Kleiner, I., Tarrago, G., Brown, L.R. (2001). Assignments and intensities of $^{14}\text{NH}_3$ hot bands in the 5–8 μm ($3\nu_2 - \nu_2$, $\nu_2 + \nu_4 - \nu_2$) and 4 μm ($4\nu_2 - \nu_2$, $\nu_1 - \nu_2$, $\nu_3 - \nu_2$) regions, *J.Mol.Spectrosc.* 209: 30–49.

- Cottaz, C., Kleiner, I., Tarrago, G., Brown, L. R., Margolis, J. S., Poynter, P. L., Pickett, H. M., Fouchet, T. & Drossart, P. (2000). Line positions and intensities in the $2\nu_2/\nu_4$ vibrational system of $^{14}\text{NH}_3$ near 5-7 μm , *JQSRT* 203: 285–309.
- Culshaw, B., Stewart, G., Dong, F., Tandy, C. & Moodie, D. (1998). Fibre optic techniques for remote spectroscopic methane detection from concept to system realisation, *Sensors & Actuators B: Chemical* 51: 25–37.
- Dakin J.P. & Chambers P. (2004). Review of methods of optical gas detection by direct optical spectroscopy with emphasis on correlation spectroscopy, *NATO Science Series, Volume 224, Part 2*, 457-477,
- Dakin, J. P., Wade, C. A., Pinchbeck, D. & Wykes, J. S. (1987). A novel optical fibre methane system, *SPIE volume: 734 Fibre Optics '87: Fifth International Conference on Fibre Optics and Optoelectronics*.
- Darde, V., Thomsen, K., van Well, W. J. M. & Stenby, E. H. (2008). Chilled ammonia process for CO_2 capture, *Greenhouse Gas Control Technologies 9, Proceedings of the 9th International Conference on Greenhouse Gas Control Technologies (GHGT-9)*, Vol. 1, pp. 1035–1042.
- Eckhardt, H. S., Klein, K.-F., Spangenberg, B., Sun, T. & Grattan, K. T. V. (2007). Fibre-optic uv systems for gas and vapour analysis, *J. Phys.: Conf.* 85: 012018.
- Edwards, H. O. & Dakin, J. P. (1993). Gas sensors using correlation spectroscopy compatible with fibre-optic operation, *Sensors & actuators B: Chemical* 11: 9.
- Felty, W. L. (1982). From camel dung, *J. Chem. Educ.* 59: 170.
- Goody, R. (1968). Cross-correlating spectrometer, *Journal of the Optical Society of America* 58(7): 900–908.
- Guelachvili, G., Abdullah, A. H., Tu, N., Rao, K. N., Urban, S. & Papoušek, D. (1989). Analysis of high-resolution fourier transform spectra of $^{14}\text{NH}_3$ at 3.0 μm , *Journal of Molecular Spectroscopy* 133: 345–364.
- Hill, D. W. & Powell, T. (1968). *Non-Dispersive Infra-Red Gas Analysis in Science, Medicine and Industry*, Adam Hilget Ltd.
- Hills, P. C., Samson, P. J. & Webster, I. (1993). Optical fibres are intrinsically safe: reviewing the myth, *Australian Journal of Electrical and Electronics Engineering* 10(3): 207–220. ISSN:0725-2986.
- Hordvik, A., Berg, A. & Thingbø, D. (1983). A fibre optic gas detection system, *proceedings 9th international conference on Optical Communications, 'ECOC 83'*, p. 317.
- Howard, J. B. & Rees, D. (1996). Structural basis of biological nitrogen fixation, *Chem. Rev.*, 96: 2965–2982.
- Inaba, H., Kobayasi, T., HIRAMA, M. & Hamza, M. (1979). Optical-fibre network system for air pollution monitoring over a wide area by optical absorption method, *Electronics Letters* 15(23): 749–751.
- Keller-Rudek, H. & Moortgat, G. K. (2006). *MPI-Mainz-UV-VIS Spectral Atlas of Gaseous Molecules*, Max-Planck-Gesellschaft zur Förderung der Wissenschaften e.V., chapter Spectral-Atlas-Mainz.
- Kleiner, I., Brown, L. R., Tarrago, G., Kou, Q.-L., Picque, N., Guelachvili, G., Dana, V. & Mandin, J.-Y. (1999). Line positions and intensities in the vibrational system ν_1, ν_3 and $2\nu_4$ of $^{14}\text{NH}_3$ near 3 micron, *J.Mol.Spectrosc.* 193: 46–71.
- Kleiner, I., Tarrago, G. & Brown, L. R. (1995). Positions and intensities in the $3\nu_2/\nu_2 + \nu_4$ vibrational system of $^{14}\text{NH}_3$ near 4 micron, *Journal of Molecular Spectroscopy* 173: 120–145.

- Kobayashi, T., Hirana, M. & Inaba, H. (1981). Remote monitoring of NO₂ molecules by differential absorption using optical fibre link, *Applied Optics* 20(19): 3279.
- Kosterev, A. A. & Tittel, F. K. (2004). Ammonia detection by use of quartz-enhanced photoacoustic spectroscopy with a near-ir telecommunication diode laser, *Applied Optics* 43: 6213–6217.
- Levey, P. R. & van Bennekom, A. (1995). A mechanistic study of the effects of nitrogen on the corrosion properties of stainless steels, *Corrosion* 51(12): 911–921.
- Luft, K. F. (1947). Anwendung des ultraroten spektrums in der chemischen industrie, *Angew. Chem.* 19(B): 2.
- Malins, C., Doyle, A., MacCraith, B. D., Kvasnik, F., Landl, M., Simon, P., Kalvoda, L., Lukas, R., Pufler, K. & Babusik, I. (1999). Personal ammonia sensor for industrial environments., *J Environ Monit.* 1(5): 417–422.
- Manap, H., Muda, R., O’Keeffe, S. & Lewis, E. (2009). Ammonia sensing and a cross sensitivity evaluation with atmosphere gases using optical fiber sensor, *Procedia Chemistry, Proceedings of the Eurosensors XXIII conference*, Vol. 1, pp. 959–962.
- McBride, J. . P. & Nicholls, R. W. (1972). The vibration-rotation spectrum of ammonia gas i.
- Miller, G. C. (1981). Chemical of the month: Ammonia, *J. Chem. Educ.* 58: 424–425.
- Mohebbati, A. & King, T. A. (1988). Remote detection of gases by diode laser spectroscopy, *Journal of Modern Optics* 35(3): 319–324.
- Rothman, L. S., Gamache, R. R., Goldman, A., Brown, L. R., Toth, R. A., Pickett, H. M., Poynter, R. L., Flaud, J.-M., Camy-Peyret, C., Barbe, A., Husson, N., Rinsland, C. P. & Smith, M. A. H. (1987). The hitran database: 1986 edition, *Appl. Opt.* 26: 4058–4097.
- Samide, A., Bibicu, I., Rogalski, M. S. & Preda, M. (2004). Surface study of the corrosion of carbon steel in solutions of ammonium salts using mössbauer spectrometry, *Journal of Radioanalytical and Nuclear Chemistry* 261(3): 593–596.
- Samson, P. J. & Stuart, A. D. (1989). Fibre optic gas sensing using Raman spectroscopy, *Proceedings of 14th Australian conference on optical fibre technology*, pp. 145–148.
- Schmidt, K., Michaelian, K. & Loppnow, G. (1999). Identification of major spieces in industrial metal-refining solutions with raman spectroscopy, *Applied Spectroscopy* 53(2): 139–143.
- Stewart, G., Shields, P. & Culshaw, B. (2004). Development of fibre laser systems for ring-down and intracavity gas spectroscopy in the near-IR, *Measurement Science Technology* 15: 1621–1628.
- Stueflotten, S., Christensen, T., Iversen, S., Hellvik, J. O., Almås, K., Wien, T. & Graav, A. (1982). An infrared fibre optic gas detection system, *Proceedings OFS-2 international conference*, pp. 87–90.
- Sun, P., Ayre, C. & Wallace, M. (2003). Characterization of organic contaminants outgassed from materials used in semiconductor fabs/processing, *Characterization And Metrology For Ulsi Technology: 2003 International Conference on Characterization and Metrology for ULSI Technology. AIP Conference Proceedings*, Vol. 683, pp. 245–253.
- Taylor, F. W., Haughton, J. T., Peskett, G. D., Rogers, C. D. & Williamson, E. J. (1972). Radiometer for remote sounding of the upper atmosphere, *Applied Optics* 11(1): 135–141.
- Tur, M., Shafir, E. & Blotekjaer, K. (1990). Source-induced noise in optical systems driven by low coherence sources, *Journal of Lightwave Technology* 8: 183–189.

- Urban, S., Tu, N., Rao, K. N. & Guelachvili, G. (1989). Analysis of high-resolution fourier transform spectra of $^{14}\text{NH}_3$ at $2.3\ \mu\text{m}$, *Journal of Molecular Spectroscopy* 133: 312–330.
- Vargas-Rodriguez, E. & Rutt, H. N. (2009). Design of CO, CO₂ and CH₄ gas sensors based on correlation spectroscopy using a fabry-perot interferometer, *Sensors & actuators B: Chemical* 137: 410–419.
- Veingerov, M. L. (1938). Eine methode der gasanalyse beruhend auf dem optisch-akustischen Tyndall-Röntgeneffekt, *Dokl. Akad. Nauk SSSR*. 19: 687.
- Whitenett, G., Stewart, G., Yu, H. & Culshaw, B. (2004). Investigation of a tuneable mode-locked fiber laser for application to multipoint gas spectroscopy, *Journal of Lightwave Technology* 22(3): 813–819.
- Zhang, D. K., Hills, P. C., Zheng, C., Wall, T. F. & Samson, P. (1992). Fibre optic ignition of combustible gas mixtures by the radiative heating of small particles, *Proceedings of the 24th International Symposium on Combustion (code 19626)*, Pittsburgh, PA, USA, pp. 1761–1767. ISSN:0082-0784.

IntechOpen

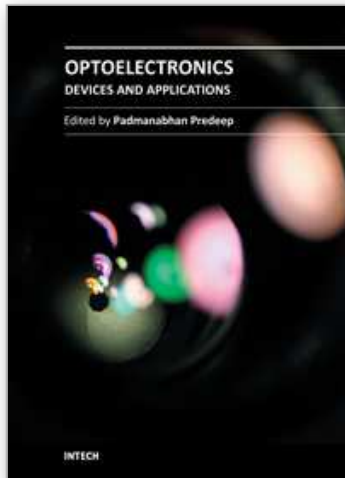

Optoelectronics - Devices and Applications

Edited by Prof. P. Predeep

ISBN 978-953-307-576-1

Hard cover, 630 pages

Publisher InTech

Published online 03, October, 2011

Published in print edition October, 2011

Optoelectronics - Devices and Applications is the second part of an edited anthology on the multifaced areas of optoelectronics by a selected group of authors including promising novices to experts in the field. Photonics and optoelectronics are making an impact multiple times as the semiconductor revolution made on the quality of our life. In telecommunication, entertainment devices, computational techniques, clean energy harvesting, medical instrumentation, materials and device characterization and scores of other areas of R&D the science of optics and electronics get coupled by fine technology advances to make incredibly large strides. The technology of light has advanced to a stage where disciplines sans boundaries are finding it indispensable. New design concepts are fast emerging and being tested and applications developed in an unimaginable pace and speed. The wide spectrum of topics related to optoelectronics and photonics presented here is sure to make this collection of essays extremely useful to students and other stake holders in the field such as researchers and device designers.

How to reference

In order to correctly reference this scholarly work, feel free to copy and paste the following:

Paul Chambers, William B. Lyons, Tong Sun and Kenneth T.V. Grattan (2011). Applications and Optoelectronic Methods of Detection of Ammonia, Optoelectronics - Devices and Applications, Prof. P. Predeep (Ed.), ISBN: 978-953-307-576-1, InTech, Available from:

<http://www.intechopen.com/books/optoelectronics-devices-and-applications/applications-and-optoelectronic-methods-of-detection-of-ammonia>

INTECH
open science | open minds

InTech Europe

University Campus STeP Ri
Slavka Krautzeka 83/A
51000 Rijeka, Croatia
Phone: +385 (51) 770 447
Fax: +385 (51) 686 166
www.intechopen.com

InTech China

Unit 405, Office Block, Hotel Equatorial Shanghai
No.65, Yan An Road (West), Shanghai, 200040, China
中国上海市延安西路65号上海国际贵都大饭店办公楼405单元
Phone: +86-21-62489820
Fax: +86-21-62489821

© 2011 The Author(s). Licensee IntechOpen. This is an open access article distributed under the terms of the [Creative Commons Attribution 3.0 License](#), which permits unrestricted use, distribution, and reproduction in any medium, provided the original work is properly cited.

IntechOpen

IntechOpen