

We are IntechOpen, the world's leading publisher of Open Access books Built by scientists, for scientists

5,000

Open access books available

125,000

International authors and editors

140M

Downloads

Our authors are among the

154

Countries delivered to

TOP 1%

most cited scientists

12.2%

Contributors from top 500 universities



WEB OF SCIENCE™

Selection of our books indexed in the Book Citation Index
in Web of Science™ Core Collection (BKCI)

Interested in publishing with us?
Contact book.department@intechopen.com

Numbers displayed above are based on latest data collected.
For more information visit www.intechopen.com



Efficient Integration of Transgenes and Their Reliable Expression in Human Embryonic Stem Cells

Kenji Sakurai^{1,2,a}, Miho Shimoji¹, Kazuhiro Aiba^{1,3} and Norio Nakatsuji^{2,3}

¹*Stem Cell and Drug Discovery Institute*

²*Institute for Frontier Medical Sciences, Kyoto University*

³*Institute for Integrated Cell-Material Sciences (iCeMS), Kyoto University*

^a*Present affiliation: Kyowa Hakko Kirin Co., Ltd.*

Japan

1. Introduction

Human embryonic stem cells (hESCs) are promising materials for both basic and applied research fields such as human developmental biology and drug discovery because of their capacity for long-term self-renewal and differentiation into virtually all types of cells and tissues (Thomson et al., 1998; Hoffman & Carpenter, 2005). For example, with regard to their applications for drug development research, these cells can be used to test whether drugs under development are efficacious against specific diseases by using hESCs-derived disease models which show disease phenotypes (Barbaric et al., 2010; Laustriat et al., 2010).

Genetic manipulation is a useful strategy for generating cellular disease models. Random integration of exogenous genes into the genome of hESCs is the most straightforward and easiest method. Random integration, however, often results in inactivation or silencing of integrated genes in hESCs (Ellis, 2005; Liew et al., 2007; Xia et al., 2007) and also might alter the cellular phenotypes due to insertional mutagenesis, which disrupts gene functions in undefined gene regions (Hacein-Bey-Abina et al., 2003; Nienhuis et al., 2006). Furthermore, the reliability of data may be compromised by differences in the transgene integration sites when comparing multiple transgenic cell lines. Introducing transgenes by gene targeting is one way to avoid undesired gene silencing and insertional mutagenesis, but the targeting efficiency in hESCs is notoriously low (Zwaka and Thomson, 2003; Urbach et al., 2004; Irion et al., 2007; Di Domenico et al., 2008; Ruby et al., 2009). Therefore, a lot of time and effort may be required to obtain gene-targeted hESC clones. To address these issues, several strategies have been explored. Researchers have identified usable native sites for gene integration in the human genome. Bacteriophage phiC31 integrase, or adeno-associated virus type 2 (AAV2), can mediate plasmid integration into pseudo-attP sites or the adeno-associated virus integration site 1 locus in the genome, respectively (Thyagarajan et al., 2008; Smith et al., 2008). However, the human genome possesses 23 different pseudo-attP sites, so the integration site cannot be specifically controlled, and the AAV2-mediated targeting efficiency is still low (4.16%). In contrast, foreign sequences such as bacterial loxP and yeast FRT are useful for gene integrations into the genome. Both loxP and lox2272 sequences can

be introduced at the silence-resistance sites of hESCs, but the selection efficiency of recombination-mediated cassette exchange is relatively low (two out of 92 clones) (Du et al., 2009). As a result, it is thus considered that there is room for improvement in the targeting and the selection of loxP technology.

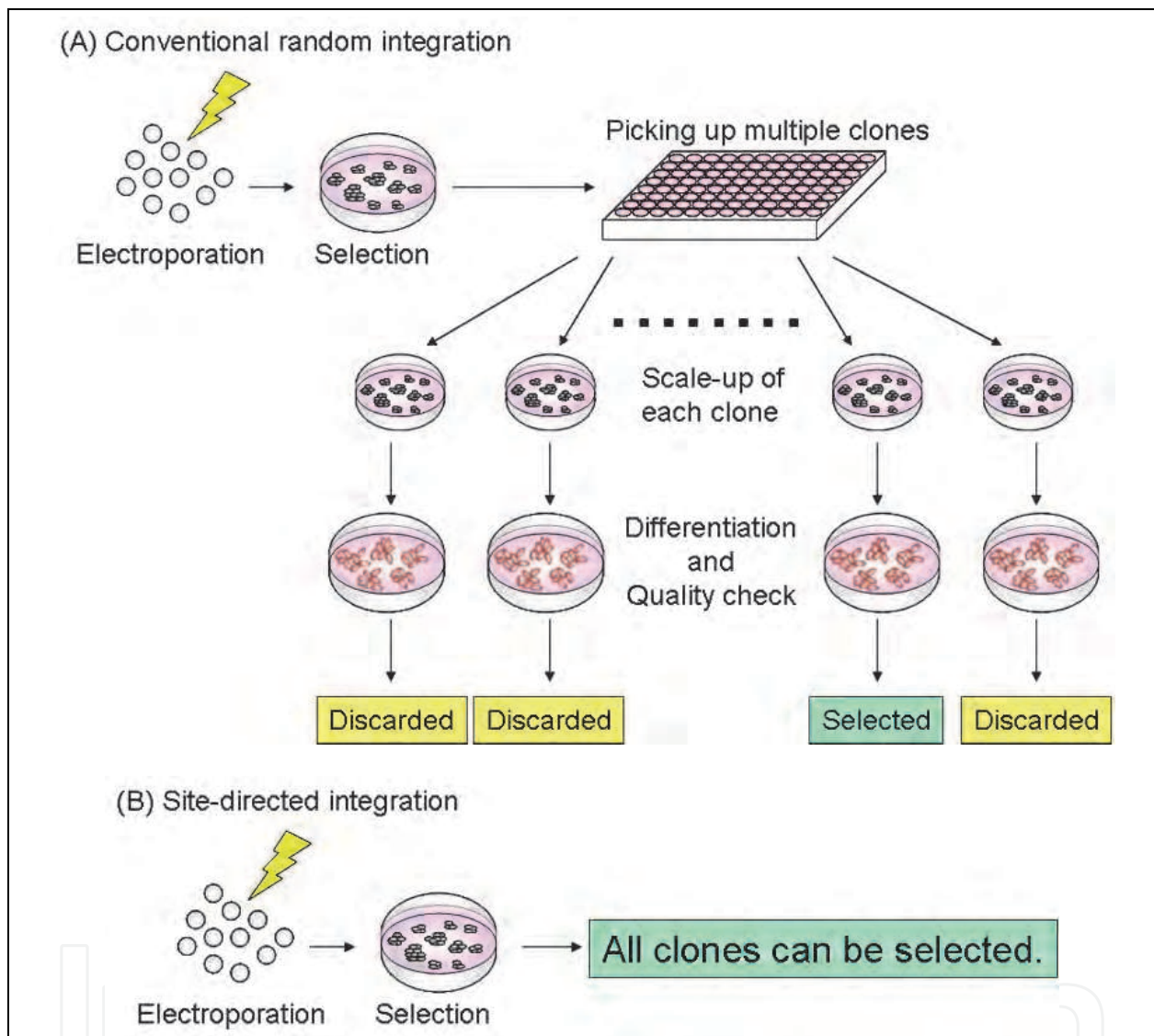

Fig. 1. Schematic diagrams of the conventional random integration and site-directed integration. (A) Conventional random integration requires selection of the proper clone(s) from among a large number of clones. This puts a burden on researchers to scale-up, differentiate and check the quality of each individual clone. (B) The site-directed integration produces clones by manipulating the only docking site. Hence, all clones can be used.

In this chapter, a site-directed integration system based on homologous recombination (HR) and Cre recombinase-mediated site-specific integration is described. First, gene targeting was performed to introduce a docking site containing two loxP sites and a hygromycin resistance gene without the first methionine codon into the hypoxanthine phosphoribosyltransferase 1 (HPRT) locus. Next, a gene of interest was inserted into the docking site by Cre recombinase. Correct insertion into the docking site confers hygromycin

resistance. Using this strategy, when an EGFP expression cassette (CAG promoter-driven EGFP) was inserted into the HPRT-docking site of the hESC line, the EGFP fluorescence was detected in all of the hygromycin-resistant clones. Furthermore, when a single vector carrying both an rtTA expression cassette and a Tetracycline (Tet) Response Element (TRE)-driven EGFP was introduced into the docking site, doxycyclin (Dox) could induce EGFP expression in the hygromycin resistant clones in a dose-dependent manner, and the clones did not leak EGFP expression in the absence of Dox.

Every time a transgene is inserted into the HPRT locus, carrying out conventional gene targeting is impractical because of the low HR efficiency, whereas the new site-directed integration system has greatly improved efficiency. Once the hESC lines with the docking site in the HPRT locus are generated by HR, any gene of interest can be integrated into the HPRT locus with nearly 100% efficiency. Furthermore, all clones created by this system have the same genetic background. This enables the effects among different genes integrated at the HPRT locus to be evaluated without consideration of data from multiple cell lines, unlike the usual need for comparison among randomly integrated hESC lines. Therefore, the new site-directed integration system makes it possible to produce transgenic hESC lines quickly and thus obtain reliable research results (Fig. 1).

2. Site-directed integration of transgenes for hESCs and its future applications

2.1 Homologous recombination for hESCs

To integrate the docking site for site-directed gene integration, we first carried out HR for hESCs. We chose the HPRT locus as the transgene integration site because, along with ROSA26 and others, this locus is considered to always allow transgene expression in the mouse genome (Bronson et al., 1996; Zambrowicz et al., 1997; McCreath et al., 2000). In addition, previous reports have shown the success of HR to the HPRT locus of hESCs (Zwaka & Thomson, 2003).

To generate the HPRT-targeting vector, the 5'- and 3'- homologous arms (7.0 kb and 2.0 kb respectively) were amplified from KhES-1 genomic DNA by polymerase chain reaction (PCR) using KOD FX (TOYOBO, Japan, also known as KOD Xtreme, supplied from Merck). This targeting vector contained a loxP site flanked by a neomycin resistance gene expression cassette, and another loxP site was located 5' to a promoter-less hygromycin resistance gene lacking the start ATG codon. These elements thus became the docking site for gene integration. To exclude the effects of external transcription factors, the docking site was inserted between two DNase I-hypersensitive site 4 (HS4) insulators (Chung et al., 1993) (Fig. 2). After the targeting vector was linearized by cutting the NotI site at the distal end of the 5' arm, it was then delivered to the female hESC KhES-1 cells (Suemori et al., 2006) by electroporation.

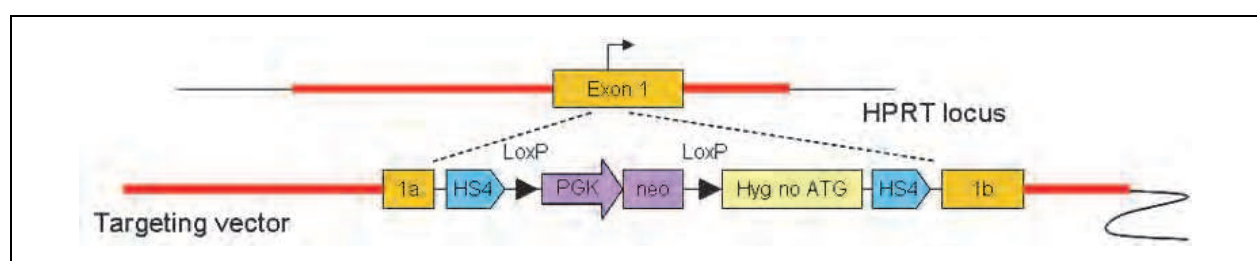

Fig. 2. The structure of the targeting vector for the human HPRT locus.

For electroporation, two confluent 100 mm dishes of KhES-1 ($2-4 \times 10^6$) cells were completely dissociated using 0.05% trypsin and 0.2 mM EDTA. Cells were mixed with 10 μ g of linearized targeting vector, electroporated in GenePulser Xcell (BioRad) using the following settings: square mode, 250 V, 4 ms x 2, 5 s interval, and then dispensed into a 60 mm dish plated with neomycin-resistant feeders (mouse embryonic fibroblasts (MEFs)). Two days after electroporation, the cells were treated with 50 μ g/ml G418 (Sigma). The next day, the G418 concentration was increased to 100 μ g/ml. Selection was performed for 10-14 days post-electroporation.

Out of the 424 G418-resistant clones screened, six (1.42%) had undergone the desired homologous recombination event (Table 1) (Sakurai et al., 2010). HR was confirmed by PCR and a Southern blotting analysis (Sakurai et al., 2010). One targeted clone, named K1-HS, was randomly selected and used for subsequent gene replacement. We also carried out gene targeting for KhES-1 sub-line 1 (Hasegawa et al., 2006) and this targeting efficiency was 0.89% (three clones underwent HR out of 336 G418-resistant clones) (Table 1).

hESC line	G418 resistance	Homologous recombination	Efficiency
KhES-1	424	6	1.42%
Sub-line 1	336	3	0.89%

Table 1. HPRT gene targeting experiments in hESCs.

2.2 Site-directed gene integration

To perform site-directed integration for the HPRT locus, we constructed the pInsert vector as a basic vector, which contained the EF1 α promoter, a Kozak sequence (Kozak, 1987), an ATG codon and a loxP site in this order (Fig. 3A). To examine whether this site-directed integration system was functional, we tried to integrate an EGFP expression vector into the HPRT locus and constructed the pInsert-Tif-CAG-EGFP vector, which carries an EGFP transgene under the control of the CAG promoter and a Cor insulator, with the tandem core element of the chicken HS4 beta globin insulator (Otsuki et al., 2005) (Fig. 3B).

Electroporation was used to introduce the plasmids into the cells. Five micrograms of a Cre expression vector (pEF1 α -Cre) and 20 μ g of the pInsert-Tif-CAG-EGFP vector were used for each electroporation procedure. The number of cells (K1-HS), the methods used for cell dissociation, and the electroporation settings were the same as those used for the gene targeting experiments. The ESCs were then plated onto hygromycin-resistant MEFs (Dainippon Sumitomo Pharma, Japan). Hygromycin selection (40 μ g/ml, Invitrogen) was started two days after electroporation, and was performed for 10-14 days post-electroporation.

In the presence of hygromycin, survival is highly skewed towards clones that have undergone the correct recombination event. This is because our method requires the reconstitution of the hygromycin resistance gene by Cre-mediated recombination between the EF1 α promoter-ATG sequence in a plasmid vector carrying the transgene of interest and a promoter-less hygromycin resistance gene lacking a start codon in the targeted HPRT

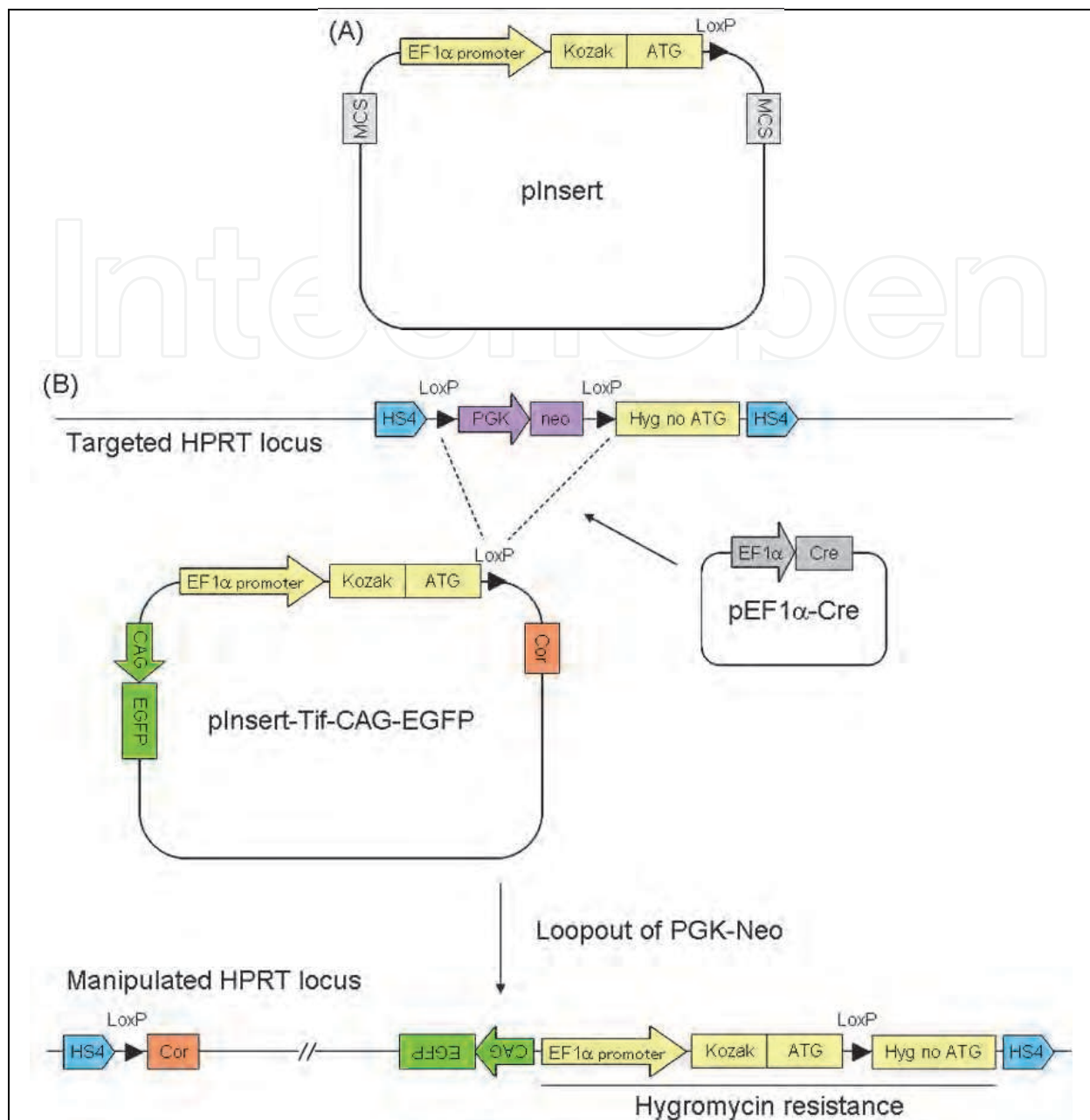

Fig. 3. (A) A vector developed for site-directed integration, pInsert. (B) The strategy used for site-directed integration. Cre recombinase-mediated integration of the pInsert vectors carrying a gene of interest confers hygromycin resistance.

locus (Fukushige & Sauer, 1992; Beard et al., 2006). In this case, only clones in which the CAG-EGFP cassette is integrated into the docking site on the HPRT locus can survive under hygromycin selection. All hygromycin resistant clones therefore theoretically express EGFP, because the HPRT locus supports strong, ubiquitous expression of inserted sequences, and it is not subject to any gene-silencing effects.

In five transfection experiments, a total of 186 hygromycin-resistant clones were obtained, and all of them were EGFP-positive (Table 2) (Sakurai et al., 2010). Eight clones were randomly selected from the hygromycin-resistant clones, and all of them expressed similar levels of EGFP. The correct and single-copy integration were confirmed by PCR and a

	Exp 1	Exp 2	Exp 3	Exp 4	Exp 5	Total
Hygromycin resistant	45	22	13	26	80	186
EGFP ⁺	45	22	13	26	80	186
Efficiency	100%	100%	100%	100%	100%	100%

Table 2. Efficiency of EGFP expression in the site-directed integration using a pInsert-Tif-CAG-EGFP vector.

Southern analysis (Sakurai et al., 2010). The correctly integrated clones were expected to have lost their neomycin resistance due to cassette exchange. As expected, all clones (80 clones that were randomly chosen from the initial 186) were neomycin-sensitive (Sakurai et al., 2010). The pInsert-Tif-CAG-EGFP integrated clones maintained their expression of EGFP for at least 6 months in an undifferentiated state in the presence of hygromycin (data not shown). When these cells were differentiated into neurons, it was possible to detect EGFP expression in the resulting neurons (Fig. 4).

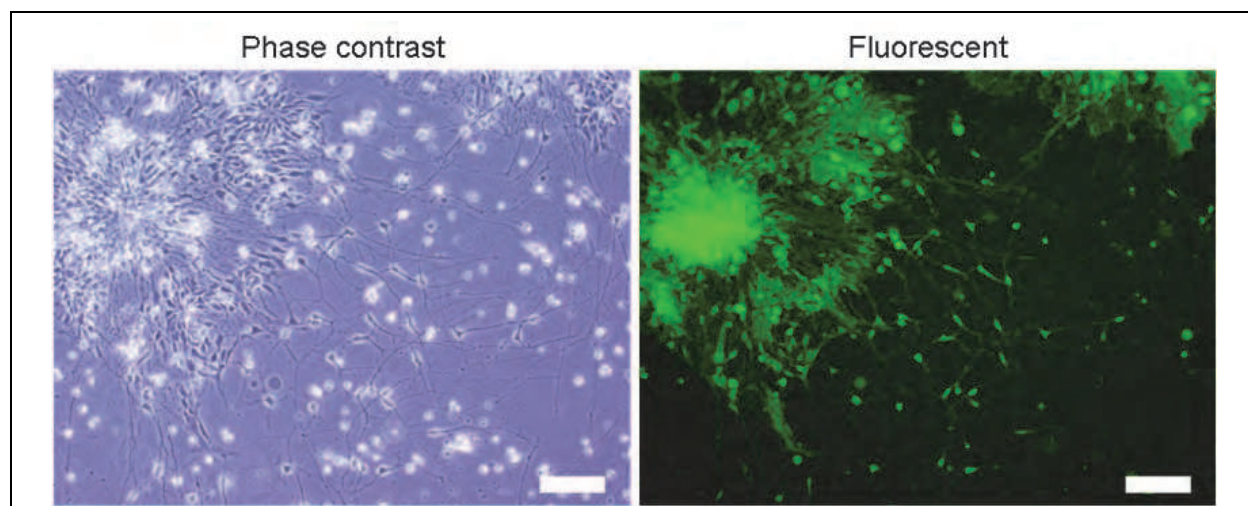

Fig. 4. Neural differentiation of a pInsert-Tif-CAG-EGFP integrated clone. Bar = 100 μ m.

2.3 Inducible gene expression based on the site-directed integration

We attempted to introduce all components of the Tet-inducible gene expression system into the docking site at the HPRT locus. Site-directed integration was performed by co-transfection of a pInsert vector carrying CAG-rtTA, the Cor insulator and TREtight-EGFP (pInsert-CTOR-EGFP) (Fig. 5), with a pEF1 α -Cre. Fifty micrograms of pInsert-CTOR-EGFP was used for this experiment, and the other methods were the same as were used for the site-directed integration of pInsert-Tif-CAG-EGFP (Sakurai et al., 2010).

Treatment with Dox for 2 days after the emergence of hygromycin-resistant colonies resulted in a dose-dependent induction of EGFP expression (Sakurai et al., 2010). Two clones

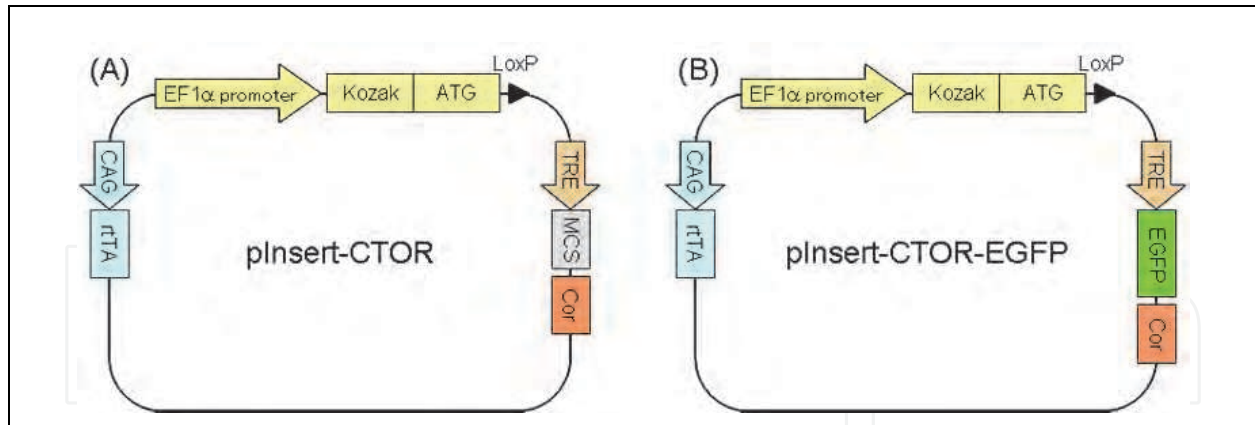

Fig. 5. (A) pInsert-CTOR and (B) pInsert-CTOR-EGFP vectors for the first-generation Tet-inducible gene expression system based on the site-directed integration.

that were randomly selected exhibited similar responsiveness to Dox (Sakurai et al., 2010). Their correct integration of pInsert-CTOR-EGFP was confirmed by PCR and a Southern blotting analysis (Sakurai et al., 2010). One of the two clones was further analyzed in additional experiments, and it could form embryoid bodies (EBs) and retained the ability to differentiate into representative cells of all three germ layers (Sakurai et al., 2010). Taken together, these results indicate that these ESCs maintain their pluripotency after a second round of genetic modification and clonal selection.

Although we put two insulators on both sides of the TRE-EGFP cassette in the pInsert-CTOR-EGFP integrants to avoid the leaky expression of EGFP, the results indicated that the faint EGFP signals could still be detected in the absence of Dox (Sakurai et al., 2010). Furthermore, although a FACS analysis showed that most of the Dox-treated live ESCs expressed EGFP, the fluorescent micrographs displayed their EGFP expression in a patchy fashion (Sakurai et al., 2010). Therefore, we tried to improve the pInsert-CTOR vector for practical use.

2.4. pInsert-Tet5 vector: the reliable Tet-on system

We investigated methods to diminish the leaky expression of transgenes downstream of the TRE. We examined the orientation of the TRE-EGFP cassette and the types of insulators. We did not modify the CAG-rtTA cassette because its structure was the same as the CAG-EGFP cassette of the pInsert-Tif-CAG-EGFP vector that demonstrated a robust expression of EGFP. As a result, we developed a pInsert-Tet5 vector with undetectable expression of EGFP in the absence of Dox.

The pInsert-Tet5 vector was generated by exchanging the Cor insulator of pInsert-CTOR for the HS4 insulator with orientation in opposition to the HS4 insulators of the K1-HS cells (Fig. 6A). The pInsert-Tet5-EGFP was introduced into K1-HS cells with pEF1 α -Cre, and transfected cells were selected by hygromycin treatment (Fig. 6B). The experimental method was the same as that used for the pInsert-CTOR-EGFP. After the emergence of hygromycin-resistant cells, Dox was added for induction of EGFP expression (Fig. 7A). Unlike the pInsert-CTOR-EGFP integrated clones with their patchy expression, the fluorescent micrographs indicated that EGFP was expressed in most of the cells in the colonies in response to Dox treatment (Fig. 7A).

We picked up three pInsert-Tet5-EGFP integrated clones randomly and analyzed their responsiveness to Dox. All three clones expressed a similar level of EGFP when they were

treated with Dox for 3 days (Fig. 7B). In the absence of Dox, the fluorescence intensities of all clones were the same as their parental K1-HS, indicating that the pInsert-Tet5-EGFP integrants do not leak any significant level of EGFP expression in the absence of Dox (Fig. 7B). Moreover, we further analyzed clone 3, and could induce EGFP expression in a Dox dose-dependent manner (Fig. 7C). Single-copy integration of a pInsert-Tet5-EGFP vector was confirmed by a Southern analysis (Fig. 7D).

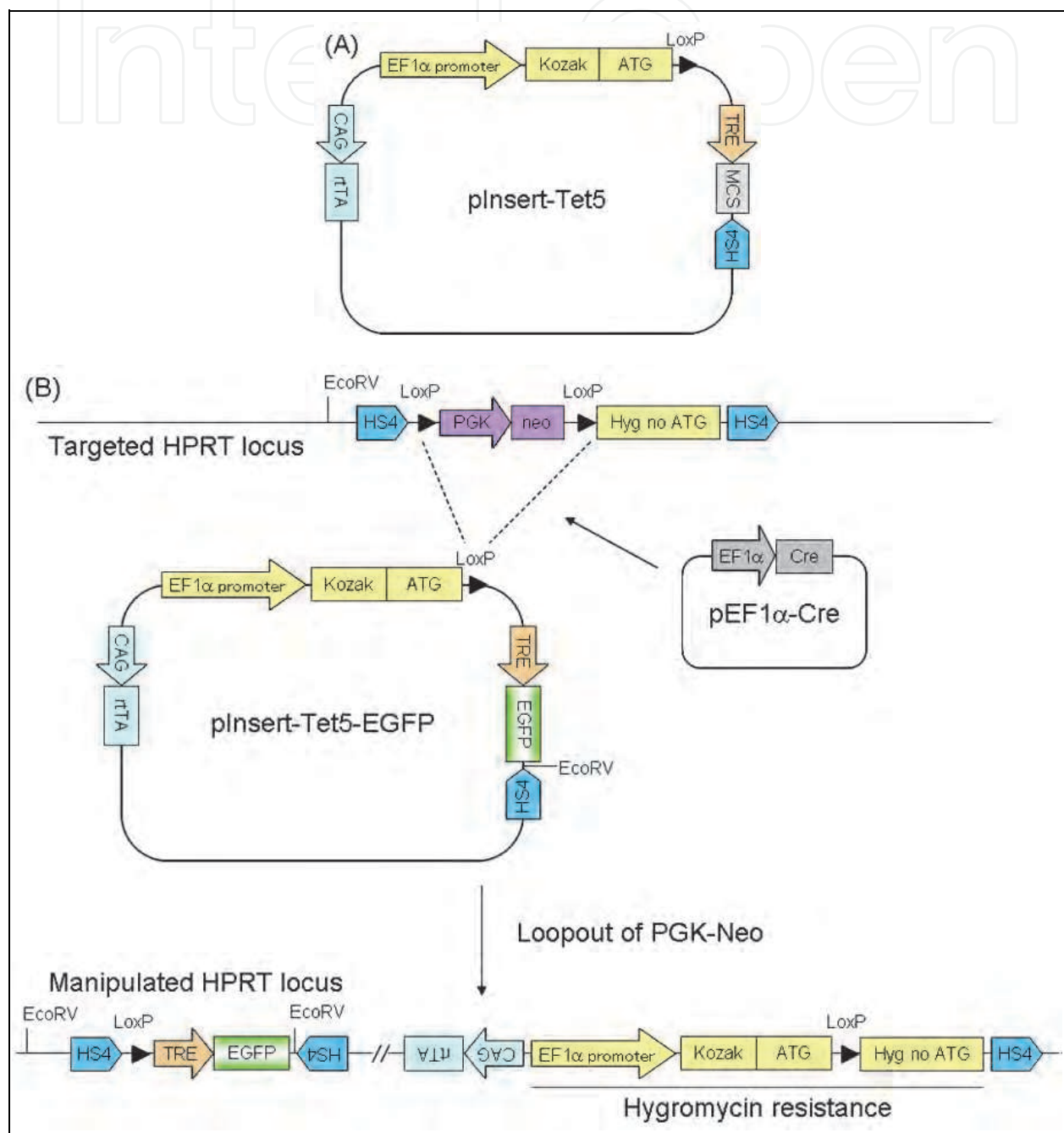

Fig. 6. (A) The pInsert-Tet5 vector used to generate a reliable Tet-On system. The insulator of this vector (HS4) was changed from that of the pInsert-CTOR vector (Cor). (B) The strategy for site-directed integration of pInsert-Tet5-EGFP. The TRE-EGFP cassettes are wedged between two HS4 insulators to avoid the leaky expression of EGFP.

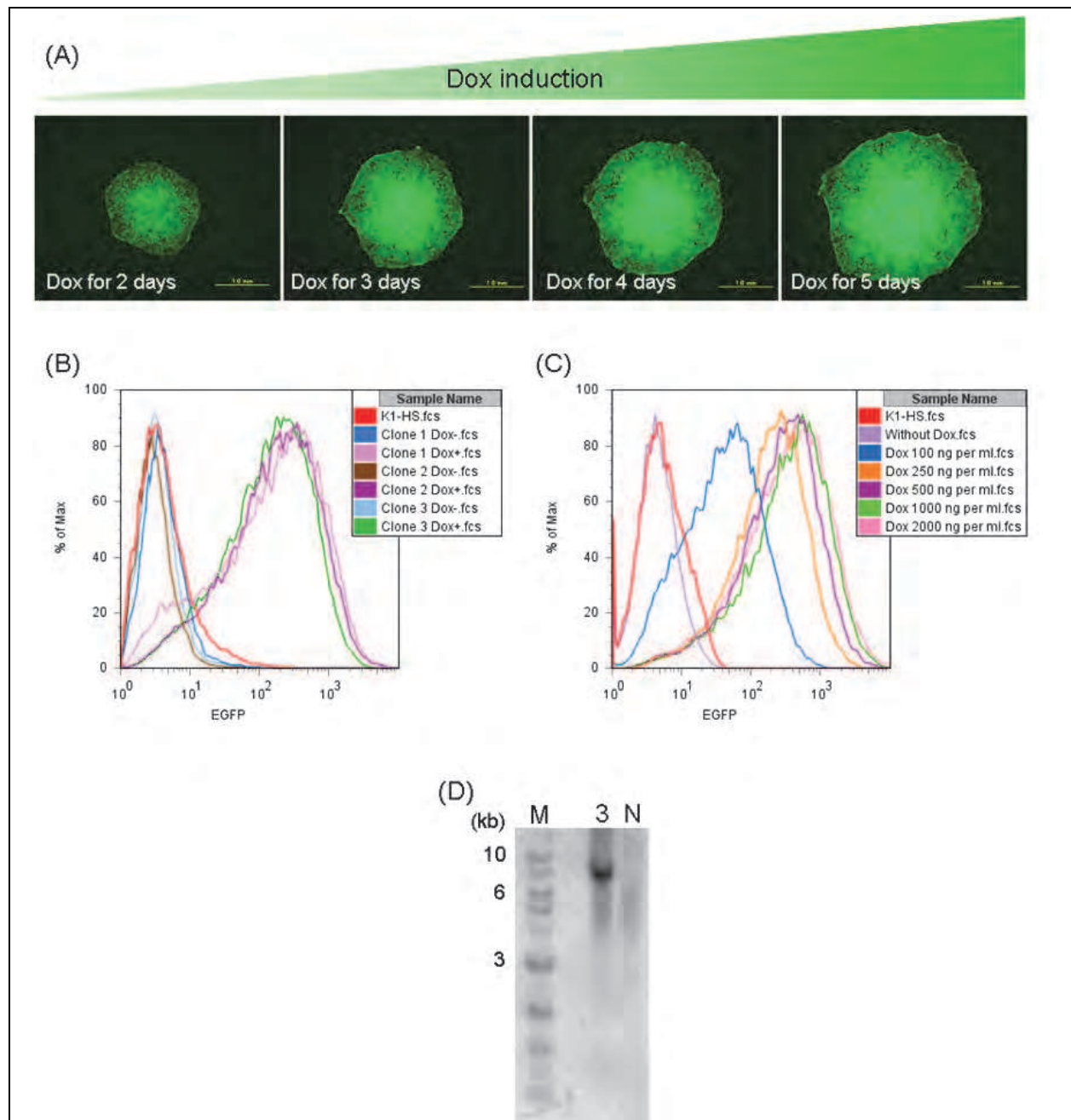

Fig. 7. (A) Dox-inducible EGFP induction of a pInsert-Tet5-EGFP integrated hygromycin-resistant clone. (B) The FACS analysis of three pInsert-Tet5-EGFP integrated clones. All of them expressed a similar level of EGFP when they were treated with 2 μ g/ml of Dox for 3 days. Furthermore, the pInsert-Tet5-EGFP integrants did not leak any detectable EGFP in the absence of Dox. (C) The dose-dependent induction of EGFP expression by Dox. Cells were treated with 100, 250, 500, 1000 or 2000 ng/ml Dox for 3 days. (D) The Southern blotting analysis. Genomic DNA was digested by EcoRV and hybridized with an EGFP probe. M: Size marker, 3: Clone 3, N: Non-integrated genome. The expected band size was 7.5 kb.

We believe that the combination of K1-HS and pInsert-Tet5 is a feasible Dox-inducible gene expression system. To establish even greater feasibility for using this system, we plan to examine to accuracy of the transgene integration, Dox responsiveness in differentiated cells,

epigenetic modification near the docking site, and genomic structure of pInsert-Tet5 integrated locus. There is a possibility that several copies of the pInsert vector may insert in tandem into the docking site in the site-directed integration system. In the case of pInsert-Tet5, tandem integration of pInsert-Tet5 vectors may abolish the reliable regulation by Dox, because the gene of interest would be downstream of the EF1 α promoter, without intervening insulators. Therefore, it will be necessary to pick up a few hygromycin-resistant clones and to confirm their correct integration of the pInsert-Tet5 vector.

2.5 Future applications of the site-directed integration system in human pluripotent stem cells

The drug discovery and development process is time-consuming and costly. Nevertheless, the average success rate of approval is approximately 11% after clinical trials (Kola and Landis, 2004). The major causes of failure are a lack of efficacy and toxicity in humans (Kola and Landis, 2004). Animal disease models can provide a wealth of information about the complexity of various disease processes, but efficacious lead compounds for these models are often found to be inefficacious during human clinical trials (Kola and Landis, 2004). Moreover, animal models do not always indicate the toxicity of compounds in humans because of the differences in the biological processes in humans and animals (Martignoni et al., 2006). These facts demonstrate the need for more predictive drug screening systems (Kola and Landis, 2004; Ebert and Svendsen, 2010). In this regard, human pluripotent stem cells are considered to be a promising cell source for drug screening because of the virtually limitless supply of normal human cells that can be differentiated into any specific cell type.

2.5.1 Disease modeling and efficacy screening

There are several approaches that have been designed to create *in vitro* disease models using pluripotent stem cells. One is that ESCs carrying serious genetic disorders can be differentiated into cells with disease-related phenotypes. Preimplantation genetic diagnosis (PGD) can identify embryos with genetic defects. The generation of disease-specific hESC lines via PGD has already been reported. For example, there are hESC lines with cystic fibrosis, myotonic dystrophy type I, Huntington's disease, adrenoleukodystrophy, Duchenne muscular dystrophy, Becker muscular dystrophy, fragile-X syndrome and thalassaemia (Pickering et al., 2005; Verlinsky et al., 2005; Mateizel et al., 2006; Stephenson et al., 2009). Differentiation of these disease-specific hESC lines into each of the specific cell types that manifest disease phenotypes may make it possible to screen for factors that restore the normal phenotype and to identify factors associated with disease initiation or progression. Furthermore, many induced pluripotent stem cells (iPSCs) have been generated from adult patients with incurable diseases and it is also hoped that they will provide new sources for drug screening (Dimos et al., 2008; Park et al., 2008; Ebert et al., 2009; Lee et al., 2009; Soldner et al., 2009; Ye et al., 2009; Maehr et al., 2009; Ye et al., 2009).

Using pluripotent stem cells carrying disease-linked genes and a high-throughput screening system, small-molecule compounds or humoral factors can be identified as potential therapeutic drugs (Barbaric et al., 2010). However, in order to more effectively screen for intracellular proteins or artificial peptides that are involved in or affect the disease process, the site-directed integration system may be more useful. In this section, we describe an example of an application of the site-directed integration system for drug screening and disease mechanism research.

First, as shown in Fig. 8, the docking site was targeted to the HPRT locus of diseased ES/iPS cells. Although the targeting efficiency of the docking site by electroporation is relatively low (Table 1), more efficient gene targeting method for human ESC/iPS cells using helper-dependent adenoviral vectors or zinc-finger nuclease has recently been reported (Suzuki et al., 2008; Lombardo et al., 2007; Zou et al., 2009) and applying these targeting methods may resolve these technical problems. Next, libraries of pInsert vectors which contain expression cassettes of cDNAs coding for various proteins or artificial peptides are constructed. Insertion of each pInsert vector into the targeted docking site confers stable expression of exogenous proteins in the diseased ES/iPS cells. These ES/iPS cells should show the phenotypes of the disease after differentiation. However, if differentiated cells show normal phenotypes, this means that the disease phenotype has been resolved, suggesting that expressing the specific exogenous protein influences the disease process. Such exogenous proteins can be identified by analyzing the sequence of the integrated pInsert vector.

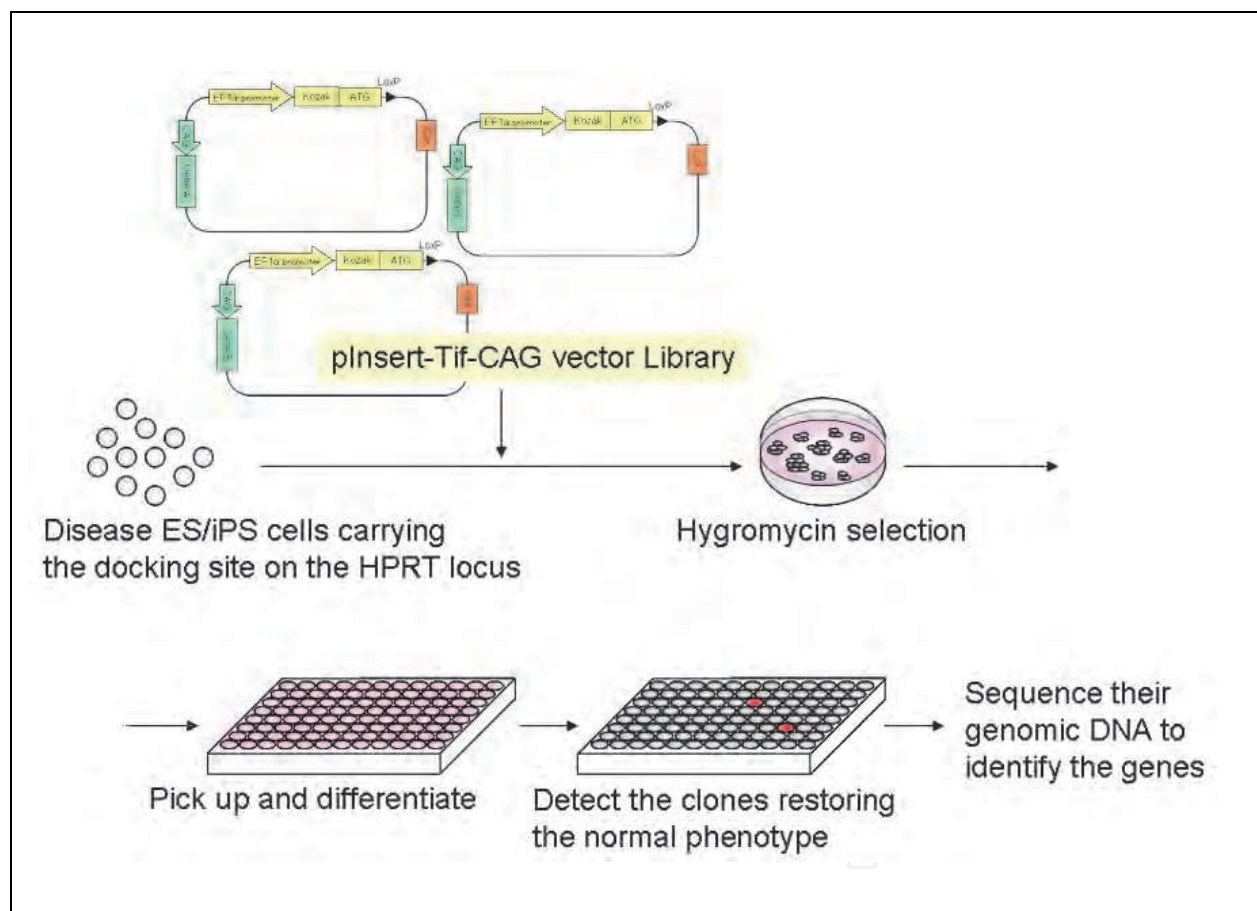

Fig. 8. A schematic diagram for discovering potential disease-curing proteins or peptides using pInsert vector libraries and disease-specific ES/iPS cells.

However, although a number of disease-specific ES/iPS cell lines have been established, only a few studies have demonstrated that the differentiated cells showed disease phenotypes (Ebert et al., 2009; Lee et al., 2009), while many disease-specific ES/iPS cells did not show any disease phenotypes, perhaps because of the late onset or multi-factorial nature of such diseases. Therefore, long-term culture might be needed before the disease

phenotypes will emerge or the disease will be initiated. However, overexpression of disease-linked genes in K1-HS cells using the site-directed integration system might enable an accelerated onset of disease phenotypes, and if overexpression of the disease-related gene leads to cell death, the pInsert-Tet5 vector system represents a suitable method because it can control gene expression by Dox, allowing for short-term gene expression.

2.5.2 Toxicity screening

Toxicity screening may be the most advanced application of pluripotent stem cells for drug screening. Public-private collaborations such as Stem Cells for Safer Medicine or Stem Cells and Drug Discovery Institute have been launched to enable consistent differentiation of stem cells into particular cell types with physiologically relevant phenotypes suitable for toxicology testing. Cardiomyocytes derived from human ES/iPS cells have already begun to be used for drug-induced cardiotoxicity screening (Asai et al., 2010).

In the drug development process, it is necessary to evaluate the metabolism of the novel compound in hepatocytes, because the liver is the main detoxification organ in the body. The models used at present are primary hepatocytes or immortalized cell lines such as HepG2, which present major limitations in terms of supply and their relevance to normal metabolic reactions, respectively (Wilkening et al., 2003; Laustriat et al., 2010). Recently, Inamura et al. reported the efficient generation of hepatoblasts from human pluripotent stem cells (Inamura et al., 2011). However, it is still difficult to obtain homogeneous populations of mature hepatocytes, and contamination with other unwanted cell types decreases the reliability of the toxicity data. Using a pInsert vector equipped with a lineage-specific selection marker and an HS4 insulator downstream of loxP may enable the reproducible production of concentrated hepatocytes.

2.5.3 Applications for cellular medicine

Human pluripotent stem cells are expected to provide sources for cellular therapy as well as drug screening. Geron Corporation already started a phase I clinical trial of transplantation of oligodendrocyte progenitor cells derived from hESCs to patients with spinal cord injury (<http://www.geron.com/GRNOPC1Trial/>). However, when transplanting differentiated cells from human ES/iPS cells, it is necessary to consider the potential for uncontrollable overproliferation and tumor formation due to implantation of small numbers of undifferentiated cells. Using the pInsert-Tet5-like vector equipped with an undifferentiated state-specific promoter instead of the CAG promoter and a proper suicide gene downstream of TRE may resolve this problem (Fig. 9). Because the undifferentiated cells will die in the presence of Dox, administration of Dox to transplant recipients can remove the undifferentiated cells.

When differentiated cells are provided for cellular therapy, it is important to determine how to differentiate the hES/iPS cells efficiently into a single type of cells. If differentiation promoting factors are identified, they could be useful in the production of hES/iPS cell-derived differentiated cells. However, there have been only a few studies using high-throughput screening methods to discover small molecules that increase the differentiation of hES/iPS cells into specific cell lineages (Borowiak et al., 2009; Zhu et al., 2009). Our pInsert-Tet5 vector can also identify proteins with activities promoting differentiation. First, pInsert-Tet5 libraries which are equipped with a variety of cDNAs downstream of TRE can

be introduced into K1-HS cells. Hygromycin-resistant clones can then be induced to desired differentiation lineages, and then Dox can be added at various stages of differentiation. Differentiation-promoting factors at the different stages can then be identified by sequencing the cDNAs from clones whose differentiation efficiency has been increased by the administration of Dox.

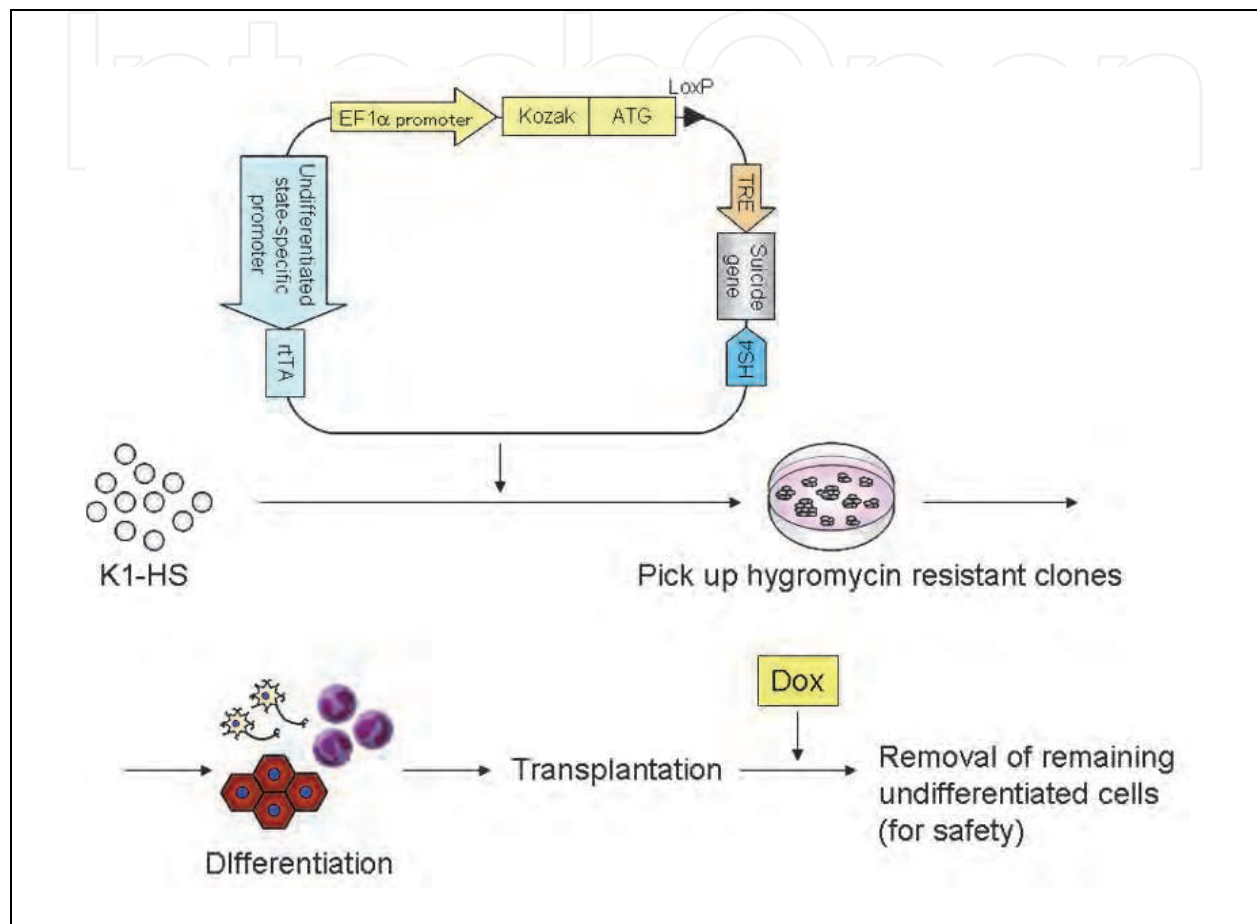

Fig. 9. A theoretic method to remove any remaining undifferentiated cells after transplantation using the inducible gene expression system based on the pInsert vector.

3. Conclusion

We have performed gene targeting in hESCs to introduce a transgene docking site into the HPRT locus, and have demonstrated high efficiency Cre-mediated integration of a given construct into this docking site. Moreover, we have developed a Tet-On system with undetectable background expression based on this site-directed integration. This review also discussed the potential applications of our site-directed integration system for drug discovery, toxicity screening and cell-based therapy.

4. Acknowledgment

We thank all members of the Stem Cell and Drug Discovery Institute for their excellent technical assistance, fruitful discussions and valuable suggestions.

5. References

- Asai, Y.; Tada, M.; Otsuji, T.G. & Nakatsuji, N. (2010). Combination of functional cardiomyocytes derived from human stem cells and a highly-efficient microelectrode array system: an ideal hybrid model assay for drug development. *Curr. Stem Cell Res. Ther.*, Vol. 5, No. 3, pp. 227-232, ISSN 1574-888X
- Barbaric, I.; Gokhale, P.J. & Andrews, P.W. (2010). High-content screening of small compounds on human embryonic stem cells. *Biochem. Soc. Trans.*, Vol. 38, No. 4, pp. 1046-50, ISSN 0300-5127
- Beard, C.; Hochedlinger, K.; Plath, K.; Wutz, A. & Jaenisch, R. (2006). Efficient method to generate single-copy transgenic mice by site-specific integration in embryonic stem cells. *Genesis*, Vol. 44, No. 1, pp. 23-28, ISSN 1526-954X
- Borowiak, M.; Maehr, R.; Chen, S.; Chen, A.E.; Tang, W.; Fox, J.L.; Schreiber, S.L. & Melton, D.A. (2009). Small molecules efficiently direct endodermal differentiation of mouse and human embryonic stem cells. *Cell Stem Cell*, Vol. 4, No. 4, pp. 348-358, ISSN 1934-5909
- Bronson, S.K.; Plaehn, E.G.; Kluckman, K.D.; Hagaman, J.R.; Maeda, N. & Smithies, O. (1996). Single-copy transgenic mice with chosen-site integration. *Proc. Natl. Acad. Sci. U S A*, Vol. 93, No. 17, pp. 8804-8808, ISSN 0027-8424
- Chung, J.H.; Whiteley, M. & Felsenfeld, G. (1993). A 5' element of the chicken beta-globin domain serves as an insulator in human erythroid cells and protects against position effect in *Drosophila*. *Cell*, Vol. 74, No. 3, pp. 505-514, ISSN 0092-8674
- Di Domenico, A.I.; Christodoulou, I.; Pells, S.C.; McWhir, J. & Thomson, A.J. (2008). Sequential genetic modification of the hprt locus in human ESCs combining gene targeting and recombinase-mediated cassette exchange. *Cloning and stem cells*, Vol. 10, No. 2, pp. 217-230, ISSN 1536-2302
- Dimos, J.T.; Rodolfa, K.T.; Niakan, K.K.; Weisenthal, L.M.; Mitsumoto, H.; Chung, W.; Croft, G.F.; Saphier, G.; Leibel, R.; Golland, R.; Wichterle, H.; Henderson, C.E. & Eggan, K. (2008). Induced pluripotent stem cells generated from patients with ALS can be differentiated into motor neurons. *Science*, Vol. 321, No. 5893, pp. 1218-1221, ISSN 0036-8075
- Du, Z.W.; Hu, B.Y.; Ayala, M.; Sauer, B. & Zhang, S.C. (2009). Cre Recombination-Mediated Cassette Exchange for Building Versatile Transgenic Human Embryonic Stem Cells Lines. *Stem Cells*, Vol. 27, No. 5, pp. 1032-1041, ISSN 1066-5099
- Ebert, A.D.; Yu, J.; Rose, F.F. Jr.; Mattis, V.B.; Lorson, C.L.; Thomson, J.A. & Svendsen, C.N. (2009). Induced pluripotent stem cells from a spinal muscular atrophy patient. *Nature*, Vol. 457, No. 7227, pp. 277-280, ISSN 0028-0836
- Ebert, A.D. & Svendsen, C.N. (2010). Human stem cells and drug screening: opportunities and challenges. *Nat. Rev. Drug Discov.*, Vol. 9, No. 5, pp. 367-372, ISSN 1474-1776
- Ellis, J. (2005). Silencing and variegation of gammaretrovirus and lentivirus vectors. *Hum. Gene Ther.*, Vol. 16, No. 11, pp. 1241-1246, ISSN 1043-0342
- Fukushige, S. & Sauer, B. (1992). Genomic targeting with a positive-selection lox integration vector allows highly reproducible gene expression in mammalian cells. *Proc. Natl. Acad. Sci. U S A*, Vol. 89, No. 17, pp. 7905-7909, ISSN 0027-8424

- Hacein-Bey-Abina, S.; Von Kalle, C.; Schmidt, M.; McCormack, M.P.; Wulffraat, N.; Leboulch, P.; Lim, A.; Osborne, C.S.; Pawliuk, R.; Morillon, E.; Sorensen, R.; Forster, A.; Fraser, P.; Cohen, J.I.; de Saint Basile, G.; Alexander, I.; Wintergerst, U.; Frebourg, T.; Aurias, A.; Stoppa-Lyonnet, D.; Romana, S.; Radford-Weiss, I.; Gross, F.; Valensi, F.; Delabesse, E.; Macintyre, E.; Sigaux, F.; Soulier, J.; Leiva, L.E.; Wissler, M.; Prinz, C.; Rabbitts, T.H.; Le Deist, F.; Fischer, A. & Cavazzana-Calvo, M. (2003). LMO2-associated clonal T cell proliferation in two patients after gene therapy for SCID-X1. *Science*, Vol. 302, No. 5644, pp. 415-419, ISSN 0036-8075
- Hasegawa, K.; Fujioka, T.; Nakamura, Y.; Nakatsuji, N. & Suemori, H. (2006). A method for the selection of human embryonic stem cell sublines with high replating efficiency after single-cell dissociation. *Stem Cells*, Vol. 24, No. 12, pp. 2649-2660, ISSN 1066-5099
- Hoffman, L.M. & Carpenter, M.K. (2005). Characterization and culture of human embryonic stem cells. *Nat. Biotechnol.*, Vol. 23, No. 6, pp. 699-708, ISSN 1087-0156
- Inamura, M.; Kawabata, K.; Takayama, K.; Tashiro, K.; Sakurai, F.; Katayama, K.; Toyoda, M.; Akutsu, H.; Miyagawa, Y.; Okita, H.; Kiyokawa, N.; Umezawa, A.; Hayakawa, T.; Furue, M.K. & Mizuguchi, H. (2011). Efficient Generation of Hepatoblasts From Human ES Cells and iPS Cells by Transient Overexpression of Homeobox Gene HEX. *Mol. Ther.*, Vol. 19, No. 2, pp. 400-407, ISSN 1525-0016
- Irion, S.; Luche, H.; Gadue, P.; Fehling, H.J.; Kennedy, M. & Keller, G. (2007). Identification and targeting of the ROSA26 locus in human embryonic stem cells. *Nat. Biotechnol.*, Vol. 25, No. 12, pp. 1477-1482, ISSN 1087-0156
- Kola, I. & Landis, J. (2004). Can the pharmaceutical industry reduce attrition rates? *Nat. Rev. Drug Discov.*, Vol. 3, No. 8, pp. 711-715, ISSN 1474-1776
- Kozak, M. (1987). An analysis of 5'-noncoding sequences from 699 vertebrate messenger RNAs. *Nucleic Acids Res.*, Vol. 15, No. 20, pp. 8125-8148, ISSN 0305-1048
- Laustriat, D.; Gide, J. & Peschanski, M. Human pluripotent stem cells in drug discovery and predictive toxicology. *Biochem. Soc. Trans.*, Vol. 38, No. 4, pp. 1051-57, ISSN 0300-5127
- Lee, G.; Papapetrou, E.P.; Kim, H.; Chambers, S.M.; Tomishima, M.J.; Fasano, C.A.; Ganat, Y.M.; Menon, J.; Shimizu, F.; Viale, A.; Tabar, V.; Sadelain, M. & Studer, L. (2009). Modelling pathogenesis and treatment of familial dysautonomia using patient-specific iPSCs. *Nature*, Vol. 461, No. 7262, pp. 402-406, ISSN 0028-0836
- Liew, C.G.; Draper, J.S.; Walsh, J.; Moore, H. & Andrews, P.W. (2007). Transient and stable transgene expression in human embryonic stem cells. *Stem Cells*, Vol. 25, No. 6, pp. 1521-1528, ISSN 1066-5099
- Lombardo, A.; Genovese, P.; Beausejour, C.M.; Colleoni, S.; Lee, Y.L.; Kim, K.A.; Ando, D.; Urnov, F.D.; Galli, C.; Gregory, P.D.; Holmes, M.C. & Naldini, L. (2007). Gene editing in human stem cells using zinc finger nucleases and integrase-defective lentiviral vector delivery. *Nat. Biotechnol.*, Vol. 25, No. 11, pp. 1298-1306, ISSN 1087-0156
- Maehr, R.; Chen, S.; Snitow, M.; Ludwig, T.; Yagasaki, L.; Golland, R.; Leibel, R.L. & Melton, D.A. (2009). Generation of pluripotent stem cells from patients with type 1 diabetes. *Proc. Natl. Acad. Sci. U S A*, Vol. 106, No. 37, pp. 15768-15773, ISSN 0027-8424

- Martignoni, M.; Groothuis, G.M. & de Kanter, R. (2006). Species differences between mouse, rat, dog, monkey and human CYP-mediated drug metabolism, inhibition and induction. *Expert Opin. Drug Metab. Toxicol.*, Vol. 2, No. 6, pp. 875-894, ISSN 1742-5255
- Mateizel, I.; De Temmerman, N.; Ullmann, U.; Cauffman, G.; Sermon, K.; Van de Velde, H.; De Rycke, M.; Degreef, E.; Devroey, P.; Liebaers, I. & Van Steirteghem, A. (2006). Derivation of human embryonic stem cell lines from embryos obtained after IVF and after PGD for monogenic disorders. *Hum. Reprod.*, Vol. 21, No. 2, pp. 503-511, ISSN 0268-1161
- McCreath, K.J.; Howcroft, J.; Campbell, K.H.; Colman, A.; Schnieke, A.E. & Kind, A.J. (2000). Production of gene-targeted sheep by nuclear transfer from cultured somatic cells. *Nature*, Vol. 405, No. 6790, pp. 1066-1069, ISSN 0028-0836
- Nienhuis, A.W.; Dunbar, C.E. & Sorrentino, B.P. (2006). Genotoxicity of retroviral integration in hematopoietic cells. *Mol. Ther.*, Vol. 13, No. 6, pp. 1031-1049, ISSN 1525-0016
- Otsuki, A.; Tahimic, C.G.; Tomimatsu, N.; Katoh, M.; Chen, D.J.; Kurimasa, A. & Oshimura, M. (2005). Construction of a novel expression system on a human artificial chromosome. *Biochem. Biophys. Res. Commun.*, Vol. 329, No. 3, pp. 1018-1025, ISSN 0006-291X
- Park, I.H.; Arora, N.; Huo, H.; Maherali, N.; Ahfeldt, T.; Shimamura, A.; Lensch, M.W.; Cowan, C.; Hochedlinger, K. & Daley, G.Q. (2008). Disease-specific induced pluripotent stem cells. *Cell*, Vol. 134, No. 5, pp. 877-886, ISSN 0092-8674
- Pickering, S.J.; Minger, S.L.; Patel, M.; Taylor, H.; Black, C.; Burns, C.J.; Ekonomou, A. & Braude, P.R. (2005). Generation of a human embryonic stem cell line encoding the cystic fibrosis mutation deltaF508, using preimplantation genetic diagnosis. *Reprod. Biomed. Online*, Vol. 10, No. 3, pp. 390-397, ISSN 1472-6483
- Ruby, K.M. & Zheng, B. (2009). Gene targeting in a HUES line of human embryonic stem cells via electroporation. *Stem cells*, Vol. 27, No. 7, pp. 1496-1506 ISSN 1066-5099
- Sakurai, K.; Shimoji, M.; Tahimic, C.G.; Aiba, K.; Kawase, E.; Hasegawa, K.; Amagai, Y.; Suemori, H. & Nakatsuji, N. (2010). Efficient integration of transgenes into a defined locus in human embryonic stem cells. *Nucleic Acids Res.*, Vol. 38, No. 7 e96, ISSN 0305-1048
- Smith, J.R.; Maguire, S.; Davis, L.A.; Alexander, M.; Yang, F.; Chandran, S.; French-Constant, C. & Pedersen, R.A. (2008). Robust, persistent transgene expression in human embryonic stem cells is achieved with AAVS1-targeted integration. *Stem Cells*, Vol. 26, No. 2, pp. 496-504, ISSN 1066-5099
- Soldner, F.; Hockemeyer, D.; Beard, C.; Gao, Q.; Bell, G.W.; Cook, E.G.; Hargus, G.; Blak, A.; Cooper, O.; Mitalipova, M.; Isacson, O. & Jaenisch, R. (2009). Parkinson's disease patient-derived induced pluripotent stem cells free of viral reprogramming factors. *Cell*, Vol. 136, No. 5, pp. 964-977, ISSN 0092-8674
- Stephenson, E.L.; Mason, C. & Braude, P.R. (2009). Preimplantation genetic diagnosis as a source of human embryonic stem cells for disease research and drug discovery. *BJOG*, No. 116, Vol. 2, pp. 158-165, ISSN 1470-0328

- Suemori, H.; Yasuchika, K.; Hasegawa, K.; Fujioka, T.; Tsuneyoshi, N. & Nakatsuji, N. (2006). Efficient establishment of human embryonic stem cell lines and long-term maintenance with stable karyotype by enzymatic bulk passage. *Biochem. Biophys. Res. Commun.*, Vol. 345, No. 3, pp.926-932 ISSN 0006-291X
- Suzuki, K.; Mitsui, K.; Aizawa, E.; Hasegawa, K.; Kawase, E.; Yamagishi, T.; Shimizu, Y.; Suemori, H.; Nakatsuji, N. & Mitani K. (2008). Highly efficient transient gene expression and gene targeting in primate embryonic stem cells with helper-dependent adenoviral vectors. *Proc. Natl. Acad. Sci. U S A*, Vol. 105, No. 37, pp. 13781-13786, ISSN 0027-8424
- Thomson, J.A.; Itskovitz-Eldor, J.; Shapiro, S.S.; Waknitz, M.A.; Swiergiel, J.J.; Marshall, V.S. & Jones, J.M. (1998). Embryonic stem cell lines derived from human blastocysts. *Science*, Vol. 282, No. 5391, pp. 1145-1147, ISSN 0036-8075
- Thyagarajan, B.; Liu, Y.; Shin, S.; Lakshmipathy, U.; Scheyhing, K.; Xue, H.; Ellerström, C.; Strehl, R.; Hyllner, J.; Rao, M.S. & Chesnut, J.D. (2008). Creation of engineered human embryonic stem cell lines using phiC31 integrase. *Stem Cells*, Vol. 26, No. 1, pp. 119-126, ISSN 1066-5099
- Urbach, A.; Schuldiner, M. & Benvenisty, N. (2004). Modeling for Lesch-Nyhan disease by gene targeting in human embryonic stem cells. *Stem Cells*, Vol. 22, No. 4, pp. 635-641, ISSN 1066-5099
- Verlinsky, Y.; Strelchenko, N.; Kukhareno, V.; Rechitsky, S.; Verlinsky, O.; Galat, V. & Kuliev, A. (2005). Human embryonic stem cell lines with genetic disorders. *Reprod. Biomed. Online*, Vol. 10, No. 1, pp. 105-110, ISSN 1472-6483
- Wilkening, S.; Stahl, F. & Bader A. (2003). Comparison of primary human hepatocytes and hepatoma cell line Hepg2 with regard to their biotransformation properties. *Drug Metab. Dispos.*, Vol. 31, No. 8, pp. 1035-1042, ISSN 0090-9556
- Xia, X.; Zhang, Y.; Zieth, C.R. & Zhang, S.C. (2007). Transgenes delivered by lentiviral vector are suppressed in human embryonic stem cells in a promoter-dependent manner. *Stem Cells Dev.*, Vol. 16, No. 1, pp. 167-176, ISSN 1547-3287
- Ye, L.; Chang, J.C.; Lin, C.; Sun, X.; Yu, J.; & Kan, Y.W. (2009). Induced pluripotent stem cells offer new approach to therapy in thalassemia and sickle cell anemia and option in prenatal diagnosis in genetic diseases. *Proc. Natl. Acad. Sci. U S A*, Vol. 106, No. 24, pp. 9826-9830, ISSN 0027-8424
- Ye, Z.; Zhan, H.; Mali, P.; Dowey, S.; Williams, D.M.; Jang, Y.Y.; Dang, C.V.; Spivak, J.L.; Moliterno, A.R. & Cheng, L. (2009). Human-induced pluripotent stem cells from blood cells of healthy donors and patients with acquired blood disorders. *Blood*, Vol. 114, No. 27, pp. 5473-5480, ISSN 0006-4971
- Zambrowicz, B.P.; Imamoto, A.; Fiering, S.; Herzenberg, L.A.; Kerr, W.G. & Soriano, P. (1997). Disruption of overlapping transcripts in the ROSA beta geo 26 gene trap strain leads to widespread expression of beta-galactosidase in mouse embryos and hematopoietic cells. *Proc. Natl. Acad. Sci. U S A*, Vol. 121, No. 5, pp. 3789-3794. ISSN 0027-8424
- Zhu, S.; Wurdak, H.; Wang, J.; Lyssiotis, C.A.; Peters, E.C.; Cho, C.Y.; Wu, X. & Schultz, P.G. (2009). A small molecule primes embryonic stem cells for differentiation. *Cell Stem Cell*, Vol. 4, No. 5, pp. 416-426, ISSN 1934-5909

- Zou, J.; Maeder, M.L.; Mali, P.; Pruetz-Miller, S.M.; Thibodeau-Beganny, S.; Chou, B.K.; Chen, G.; Ye, Z.; Park, I.H.; Daley, G.Q.; Porteus, M.H.; Joung, J.K. & Cheng, L. (2009). Gene targeting of a disease-related gene in human induced pluripotent stem and embryonic stem cells. *Cell Stem Cell*, Vol. 5, No. 1, pp. 97-110, ISSN 1934-5909
- Zwaka, T.P. & Thomson, J.A. (2003). Homologous recombination in human embryonic stem cells. *Nat. Biotechnol.*, Vol. 21, No. 3, pp. 319-21, ISSN 1087-0156

IntechOpen

IntechOpen

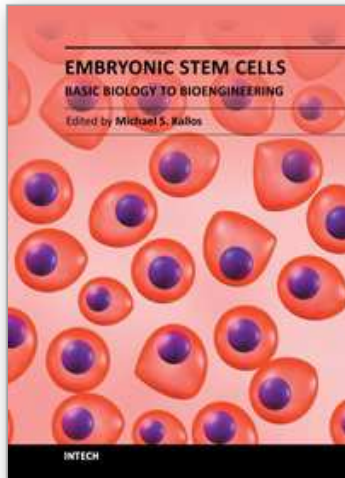

Embryonic Stem Cells - Basic Biology to Bioengineering

Edited by Prof. Michael Kallos

ISBN 978-953-307-278-4

Hard cover, 478 pages

Publisher InTech

Published online 15, September, 2011

Published in print edition September, 2011

Embryonic stem cells are one of the key building blocks of the emerging multidisciplinary field of regenerative medicine, and discoveries and new technology related to embryonic stem cells are being made at an ever increasing rate. This book provides a snapshot of some of the research occurring across a wide range of areas related to embryonic stem cells, including new methods, tools and technologies; new understandings about the molecular biology and pluripotency of these cells; as well as new uses for and sources of embryonic stem cells. The book will serve as a valuable resource for engineers, scientists, and clinicians as well as students in a wide range of disciplines.

How to reference

In order to correctly reference this scholarly work, feel free to copy and paste the following:

Kenji Sakurai, Miho Shimoji, Kazuhiro Aiba and Norio Nakatsuji (2011). Efficient Integration of Transgenes and Their Reliable Expression in Human Embryonic Stem Cells, *Embryonic Stem Cells - Basic Biology to Bioengineering*, Prof. Michael Kallos (Ed.), ISBN: 978-953-307-278-4, InTech, Available from: <http://www.intechopen.com/books/embryonic-stem-cells-basic-biology-to-bioengineering/efficient-integration-of-transgenes-and-their-reliable-expression-in-human-embryonic-stem-cells>

INTECH
open science | open minds

InTech Europe

University Campus STeP Ri
Slavka Krautzeka 83/A
51000 Rijeka, Croatia
Phone: +385 (51) 770 447
Fax: +385 (51) 686 166
www.intechopen.com

InTech China

Unit 405, Office Block, Hotel Equatorial Shanghai
No.65, Yan An Road (West), Shanghai, 200040, China
中国上海市延安西路65号上海国际贵都大饭店办公楼405单元
Phone: +86-21-62489820
Fax: +86-21-62489821

© 2011 The Author(s). Licensee IntechOpen. This chapter is distributed under the terms of the [Creative Commons Attribution-NonCommercial-ShareAlike-3.0 License](#), which permits use, distribution and reproduction for non-commercial purposes, provided the original is properly cited and derivative works building on this content are distributed under the same license.

IntechOpen

IntechOpen