

We are IntechOpen, the world's leading publisher of Open Access books Built by scientists, for scientists

5,000

Open access books available

125,000

International authors and editors

140M

Downloads

Our authors are among the

154

Countries delivered to

TOP 1%

most cited scientists

12.2%

Contributors from top 500 universities



WEB OF SCIENCE™

Selection of our books indexed in the Book Citation Index
in Web of Science™ Core Collection (BKCI)

Interested in publishing with us?
Contact book.department@intechopen.com

Numbers displayed above are based on latest data collected.
For more information visit www.intechopen.com



Tag Movement Direction Estimation Methods in an RFID Gate System

Yoshinori Oikawa
NEC TOKIN Corporation
Japan

1. Introduction

An RFID system is desired to be introduced in large gate management systems because it can read the ID of a large number of target objects simultaneously in the field of logistics and retail business. Especially, UHF RFID has gathered significant interest since it has the advantage of long distance reading and low cost of tags. Customers using an RFID gate system require several convenient functions. One of them is to know the tag movement direction for the purpose of recognition in warehousing or shipment for inventory management. Moreover it can check for undesirable objects or prevent theft. For this purpose, some sensors are established at the entrance and the exist side of the gate system in an existing system. Therefore the direction of movement of tags is judged by the time difference in the passing time at these sensors. For example, the future store of the Metro group used this gate system for their stock management system of the backyard system [1]. However, in these systems it is necessary to use optional expensive equipment such as several sensors.

In this chapter, an effective tag movement direction detection method is proposed in which an original tag communication system is used as much as possible without using optional equipment.

2. Estimation methods of the RF tag movement direction

It is basically necessary for the judgment of tag movement to obtain two or more time information of an object. For obtaining that information, it is common to use two sensors on both sides of the gate. This method corresponds to the Range-based method, which is a location allocation system (LAS) method using a fixed anchor [2][3][4][5]. A conventional RFID gate system using photoelectric sensors is shown in Fig.1. This gate can detect the movement direction of an RF tag by judging the difference between the two passing times at each sensor. For example, because the RF tag moves from the left side to the right side in the case of Fig.1, sensor 1 detects it in advance of the detection at sensor 2. Here, a new method of applying the Range-free method to RF tag direction detection is proposed.

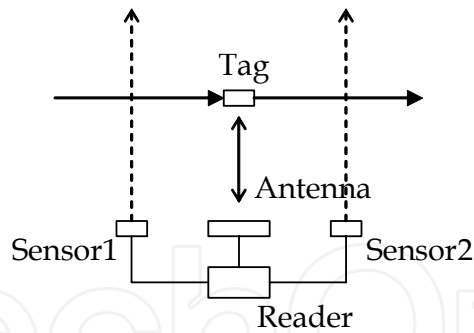

Fig. 1. Conventional RFID gate system

3. Proposed methods

3.1 Basic principle

Detection measures for measuring the time difference are considered for the RF tag and reader antennas. A double antenna method using two antennas is proposed. The configuration of this method is shown in Fig.2. The basic algorithm is that the tag movement direction is estimated by measuring the time difference of two antennas. The merit of this method is that the direction of each tag can be estimated independently. The conventional sensor system can detect only for the bulk in the case of many tags. The proposed method can estimate the movement direction for each tag even if some tags move in the opposite direction toward the other tags simultaneously.

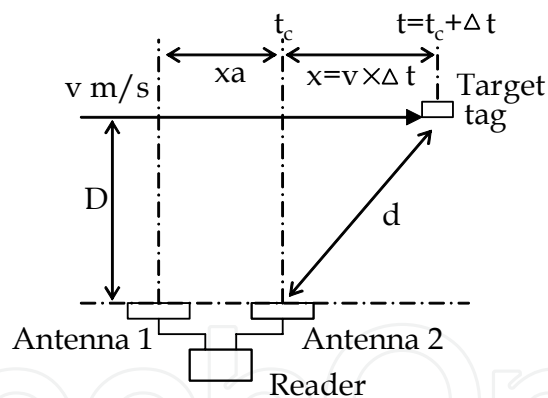

Fig. 2. Double antenna method

3.2 Attributes for estimation

The types of information obtained from a tag is the read count, received power and transmission delay. In this chapter, the former two types of information are studied because they are simpler than the last one. Three methods are considered for judgment of the detection time. They are (1) tag read time, (2) the time over the preset threshold, and (3) total judgment that considers the detection pattern or weighted time. In the case of using the time sequence pattern in the third method above, the processing function is very heavy because of complication of its algorithm. That does not match the philosophy of Range-free. Therefore, in this chapter, a weighted time center method for the third method is proposed. Each method is shown in Table 1.

Attribute Method	(a) Read count (n)	(b) Received power (P _r)
(1) Tag read	n > 1	-
(2) Threshold	n > Th ₁	P _r > Th ₂
(3) Weighted center	$\frac{\sum_i (n_i \cdot t_i)}{\sum_i n_i}$	$\frac{\sum_i (P_{ri} \cdot t_i)}{\sum_i P_{ri}}$

Table 1. Decision criteria of detection time

3.3 Basic model regarding received power

A basic model of an RFID system is shown in Fig. 3. The received power of a tag (chip) P_{tr} and the received power of a reader P_r are as follows using Friss’s formula [6].

$$P_{tr} = P_t + G_{rt} - L_a + G_{tr} \tag{1}$$

$$P_r = P_t + G_{rt} - L_a + G_{tr} - L_m + G_{tt} - L_a + G_{rr} \tag{2}$$

$$= P_t + (G_{rt} + G_{rr}) + (G_{tr} + G_{tt}) - 2 \cdot L_a - L_m$$

$$L_a = 20 \cdot \log\left(\frac{4\pi}{\lambda} \cdot d\right) \tag{3}$$

Here, G_{rt} and G_{rr} is the transmission gain and received gain of the reader antenna, G_{tt} and G_{tr} is the transmission gain and received gain of the tag antenna, L_m is the internal loss of the tag, L_a is the propagation loss in the air, d is the read distance, λ is the wavelength. Generally, the antenna of an RFID system can be used for both transmission and reception. Therefore, let G_r=G_{rt}=G_{rr}, G_t=G_{tt}=G_{tr}, then eq. (1) and eq. (2) are

$$P_{tr} = P_t + G_r + G_t - L_a \tag{4}$$

$$P_r = P_t + 2 \cdot (G_r + G_t - L_a) - L_m \tag{5}$$

Measurement results of P_r in the case of P_t=1W(30dBm), G_r=6dBiC(circular polarization antenna), G_t=0dBil(linear polarization antenna) are shown in Fig.4. This shows that the results are the same as the calculated values. Since the tag internal loss L_m depends on vendor or input level, the value of the actual used tag chip is applied.

Figure 4 shows that the distance (read range) between the reader and the tag can be approximately estimated by measuring P_r. In eq. (4) and (5), P_r is a maximum when the tag is just in front of the reader antenna. However, P_r decreases as the tag moves into farther from the center of the antenna because of its directional loss. Measurement results and

calculated values of P_r vs. the distance x between the center of the reader and tag are shown in Fig.5. From Fig.5, the tag's nearest point ($x=0$) to the reader can be estimated.

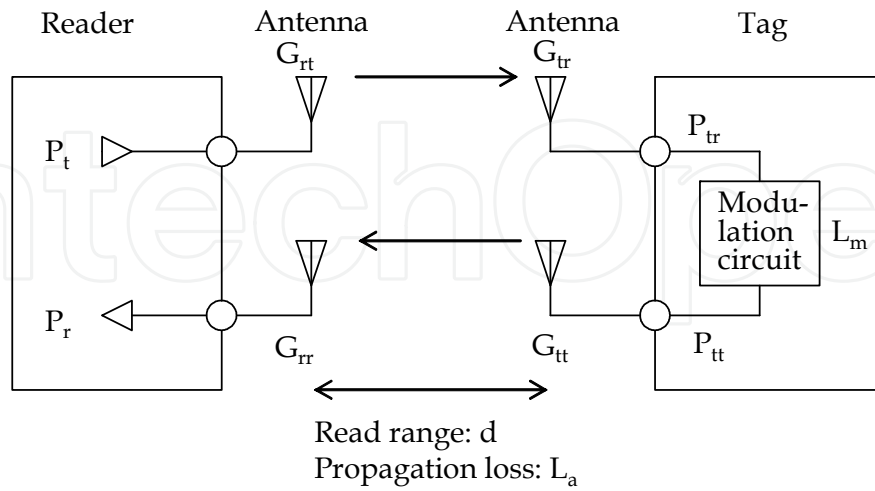

Fig. 3. RFID system model

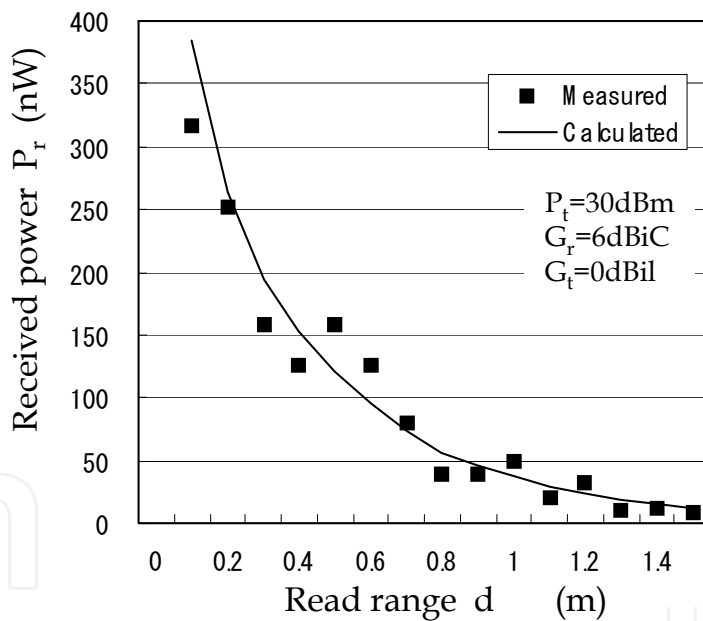

Fig. 4. Read range vs Received power

3.4 Comparison of detection methods

3.4.1 Method 1

In Method 1, the starting time to read a tag is detected as shown in Table 1(1) even if read only one time. In an actual RFID system, because tags are inventoried in advance of reading the tag, the inventory time can also be used. This method is so simple. However, it is hard to increase the decision accuracy since it sometimes happens to inverse the sequence of the read time of the two antennas.

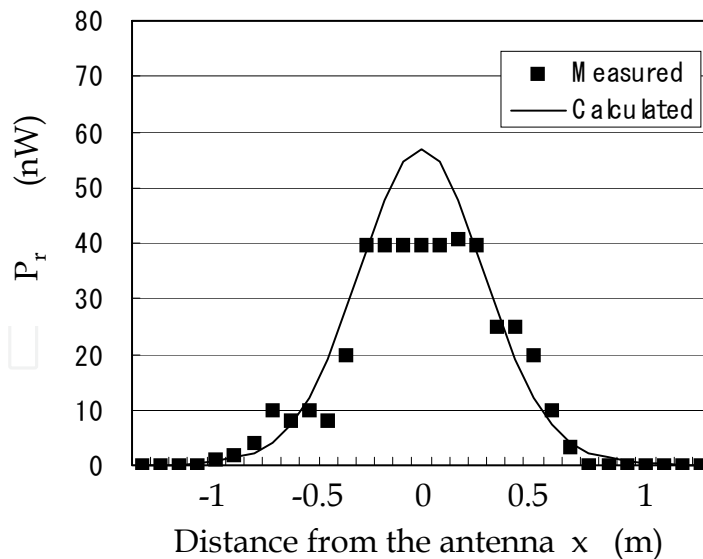

Fig. 5. Measurement result (x vs P_r)

3.4.2 Method 2

Incorrect judgment sometimes occurs due to a passing read for a reflected RF wave in the case of Method 1.

Method 2 uses the threshold of detected values and judges the direction using the time difference between each time when the detected value is over each threshold as shown in Table 1(2). This method is able to increase the accuracy of detection. However, it is sometimes hard to decide the threshold because the read count depends on the speed of movement and the received power depends on the distance between the reader antenna and the tag.

3.4.3 Method 3

Method 3 is proposed for improvement of the two methods, i.e. prevention of tentative read error caused by the influence of reflection or null points. The principal of this method is to estimate the time of the tag's nearest position from the reader antenna. Wilson has proposed the method for localization using the passive tag count percentage [7]. In this approach, tags can be estimated the closest position by detecting the peak point. However, it is difficult to adopt this method as RFID gate system because the variation of detected value reaches up to several tens of meters and is equivalent to the distance between two antennas. Therefore the algorithm we proposed is that each read time is weighted by the read count n or received power P_r , and the tag direction is estimated by the calculated difference between two weighted centers of two antennas. Recently, RFID readers become to have high-performance received power detection function [8]. Therefore, here, this method will be explained using the received power as the tag attribute. Figure 6 shows the judgment procedure of the three methods.

The detailed detection method is explained in Method 3. The received power is a function of time actually because the tag goes through at a speed of v (m/s).

Eq.(5) is shown as eq.(6) from Fig.2 and Fig.5. Δt in Fig.2 is the time difference between the passing time at the front of the reader antenna (t_c) and the present time (t).

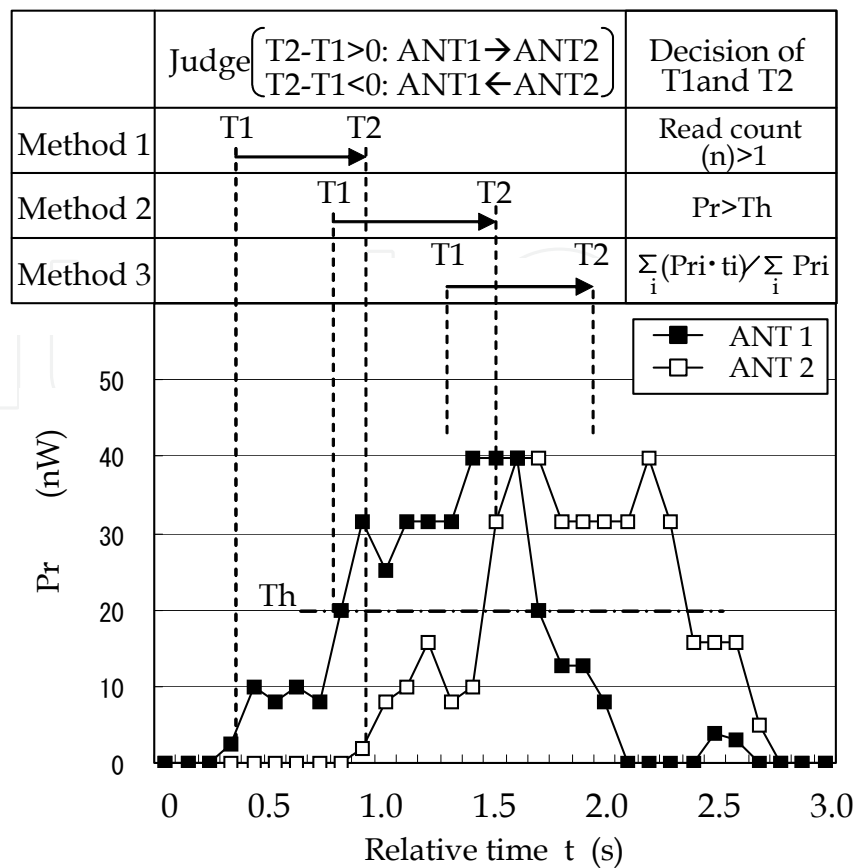

Fig. 6. Three methods in double antenna method

$$P_r(t) = P_t + 2 \cdot (G_r(t) + G_i(t) - L_a(t)) - L_m \tag{6}$$

The estimation procedure is as follows.

When the certain time before the reader starts to read tags put t_0 , weighted center of read time $t_{w1}(t_k)$ and $t_{w2}(t_k)$ from time t_0 to time t_k of antenna 1 and antenna 2 are

$$t_{w1}(t_k) = \frac{\sum_{i=0}^k P_{r1}(t_i) \cdot t_i}{\sum_{i=0}^k P_{r1}(t_i)} \tag{7}$$

$$t_{w2}(t_k) = \frac{\sum_{i=0}^k P_{r2}(t_i) \cdot t_i}{\sum_{i=0}^k P_{r2}(t_i)} \tag{8}$$

where $P_{r1}(t)$ and $P_{r2}(t)$ are the received power of the two antennas at time t .

In the eq.(7) or (8), when $t_{w2}(t_k) - t_{w1}(t_k) > 0$, it is judged that the tag moved from antenna 1 to antenna 2, and when $t_{w2}(t_k) - t_{w1}(t_k) < 0$, it is judged that the tag moved from antenna 2 to antenna 1. The calculated results in the case of Fig.6 is shown in Fig.7.

When t_{w1} and t_{w2} in the case of stable values after the elapse of a certain period of time put T1 and T2, respectively, the tag direction is finally judged by $T2 - T1$ as shown in Fig.6 .

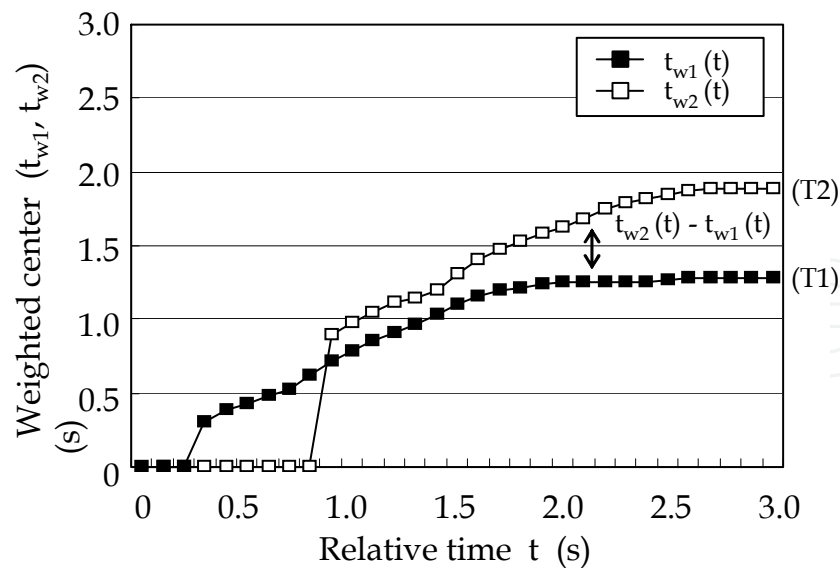

Fig. 7. Shift with time of t_{w1} and t_{w2} in Method 3

Measurement results and the experimental environment using 10 dense tags are shown in Fig.8 and Fig.9. Measurement conditions are shown below.

$P_t=30$ dBm, $G_r=6$ dBiC, $G_t=0$ dBil, $D=90$ cm, $x_a=60$ cm, $v=1$ m/s, height of antenna=1.3 m, data rate=80 kbps, Reader: NEC TOKIN (Speedway)

Tags: UPM Raflatac ShortDipole

movement direction: from antenna 1 to antenna 2 ($T_2-T_1>0$)

Because the distance between two antennas that are the same type is 60 cm, T_2-T_1 becomes 0.6 seconds in theory. There are occasional erroneous decisions because of reflection or interference in severe measurement environment, which causes undesirable reading in method 1, and tags placed in the middle (e.g. tag #3, #4, #7 and #8 in Fig.8) are hard to read in method 2.

On the other hand, method 3 is very stable because it is not misjudged, has low deviation and a desirable average. Figure 10 shows the time transition of the difference $t_{w2}-t_{w1}$ in method 3. We can see this method can obtain a stable and correct result (expectant value in the case of Fig.10 is 0.6s) even in the case of misjudgments caused by reflection and interference in the measurement stage.

4. Measurement results in Method 3

4.1 Detection of the tag direction

The detail performance of Method 3 was measured. Figure 11 shows the tag read counts and time difference T_2-T_1 in the case of two methods.

Though the deviation is wider in the case of a low read count, the judgment result is plus in pattern 1, and minus in pattern 2. Therefore it has enough stability for use as an actual tag direction decision tool. Pattern 3 shows the results in the illegal case assuming turning back in the center of the antenna. In this case, the expectation value is 0. Figure 12 shows the summary of means m and deviation σ of the measurement results of Fig.11.

By the way, an RFID system needs anti-collision technology that prevents no-read situations caused by collision when many tags are read simultaneously. The sequence to read tags is

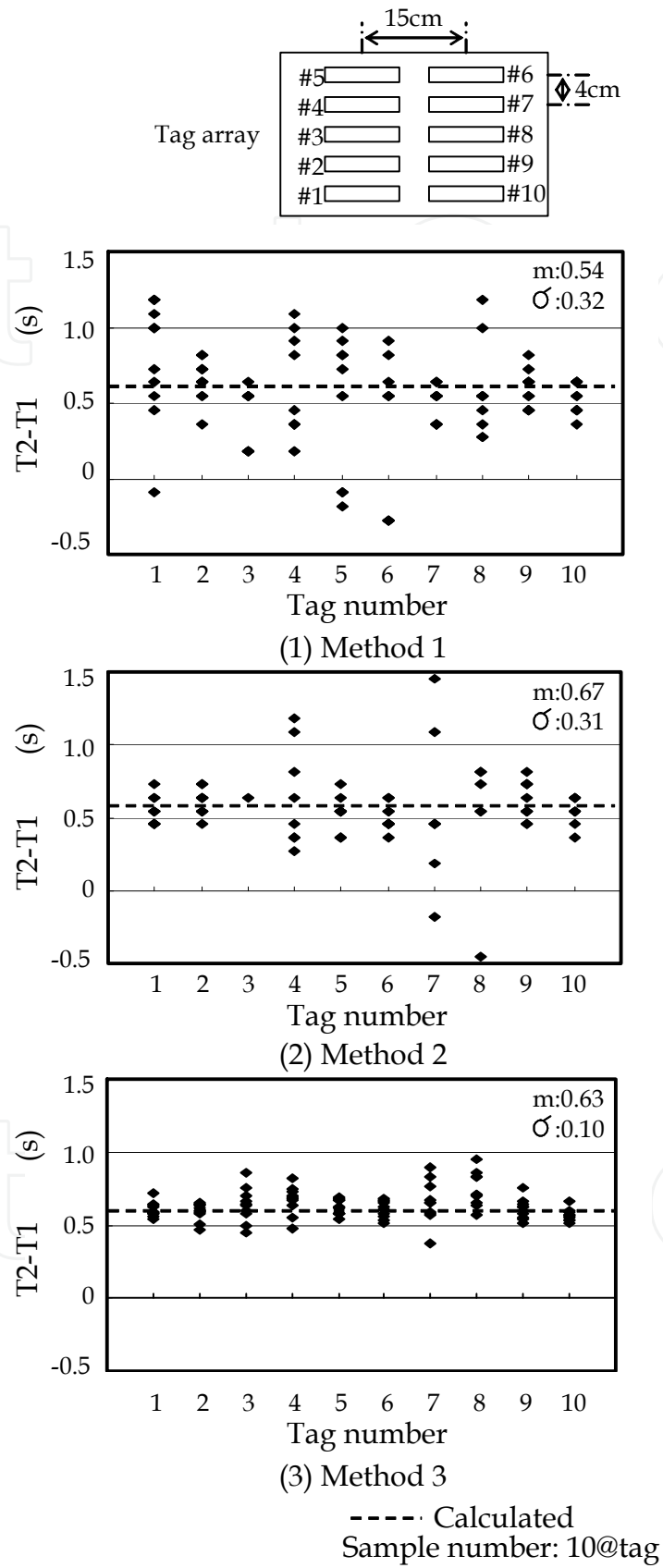

Fig. 8. Different time between two antennas

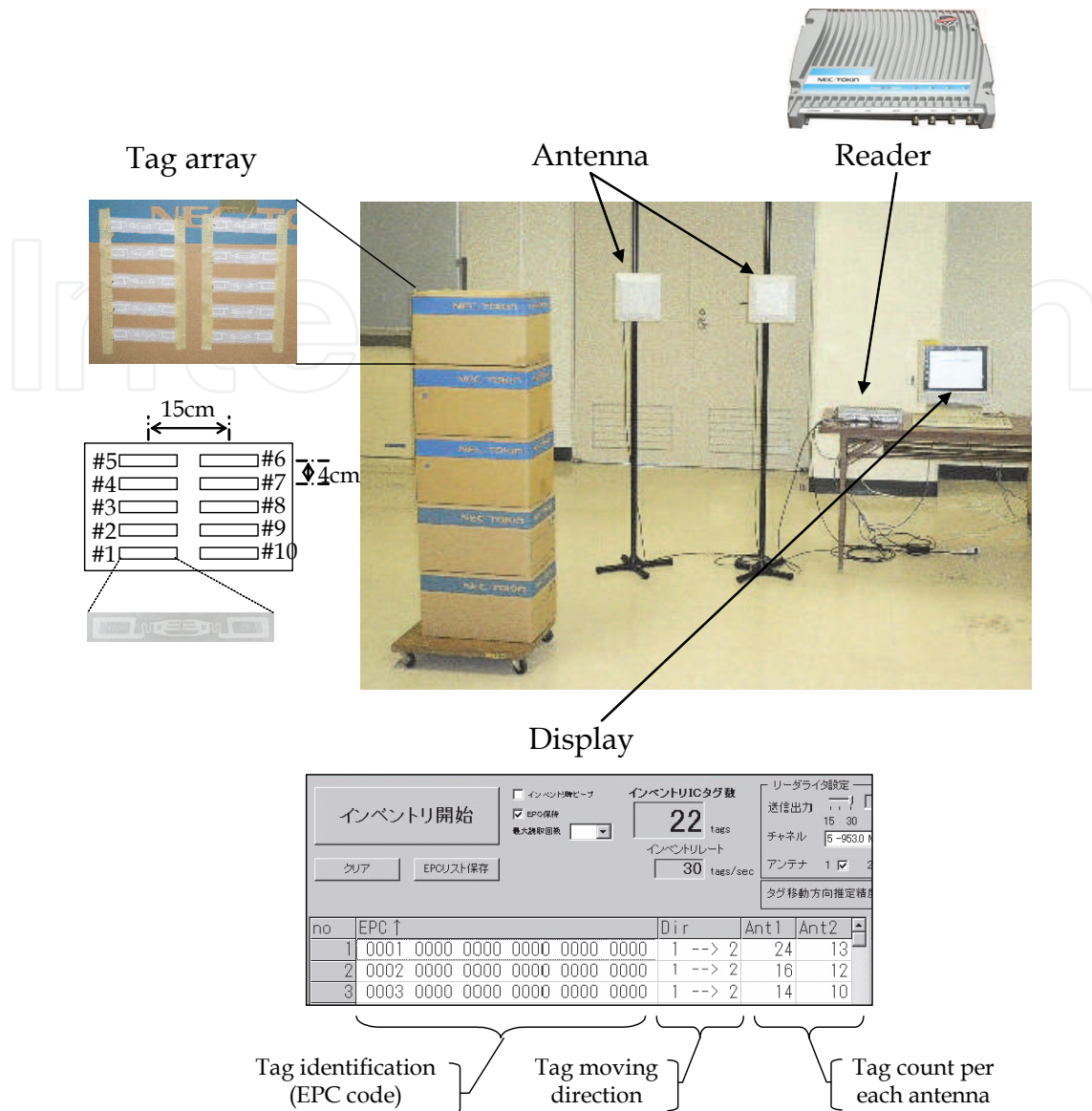

Fig. 9. Photograph of experimental environment

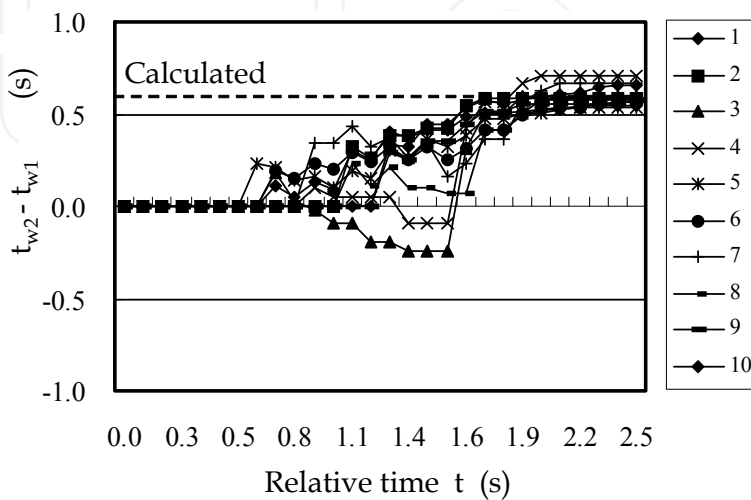

Fig. 10. Relative time vs $(t_{w2}-t_{w1})$ in method 3

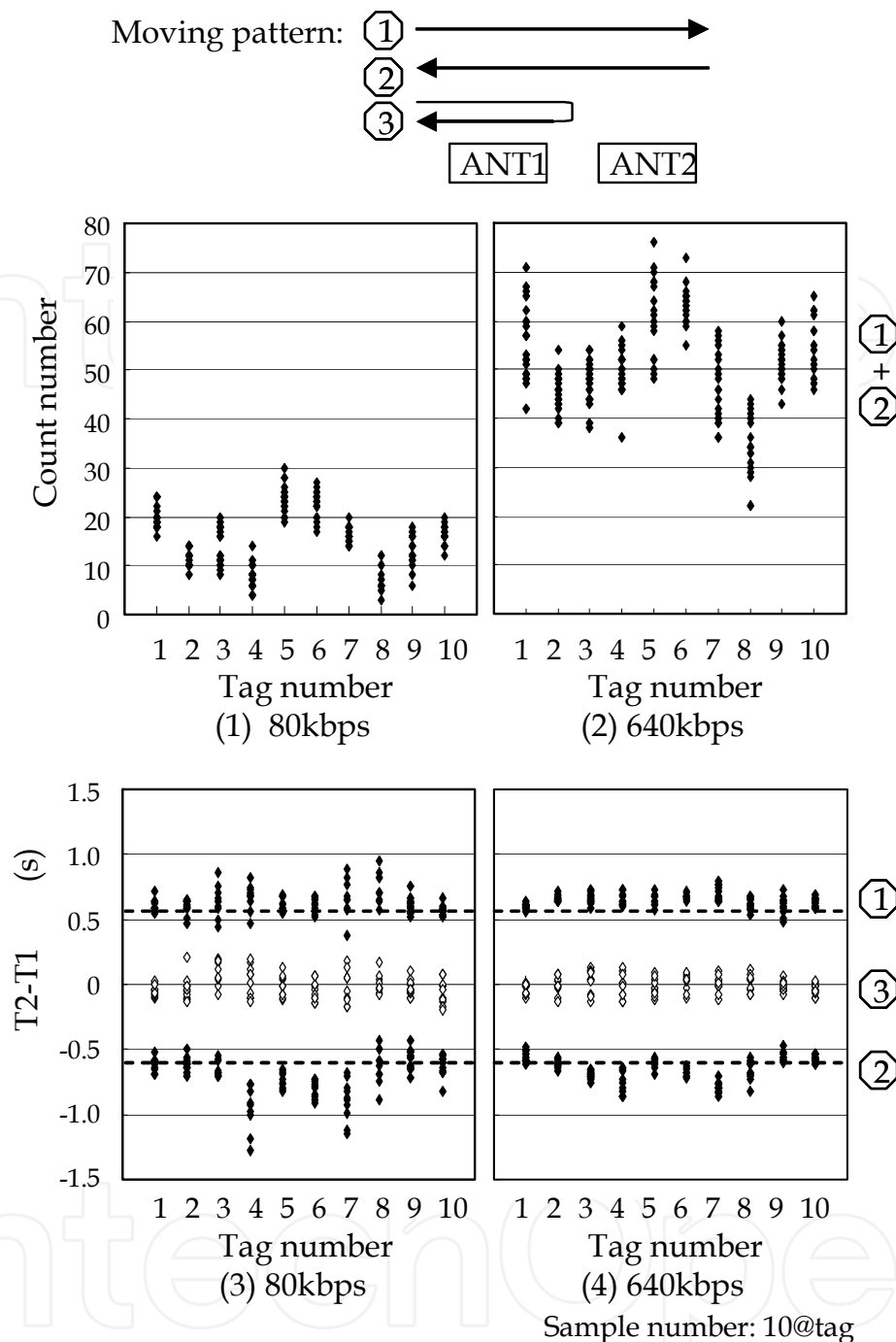

Fig. 11. Relative time vs ($t_{w2}-t_{w1}$) in method 3

random because a typical anti-collision system is used for using the probabilistic approach [9]. A variation of tag read sequence directly becomes a validation of detection time difference. Therefore, when a weighted center is normally-distributed, the time difference $T2-T1$ is also independent and identically distributed because of its reproducing property. From Fig.12, it is assumed that the criteria of detection precisely is 3σ or less, and the tag direction can be judged correctly from the data of pattern 1 and pattern 2. However, a data rate up to round 640kbps is necessary when the difference from abnormal action such as turning needs to be detected (pattern 3 in Fig.12).

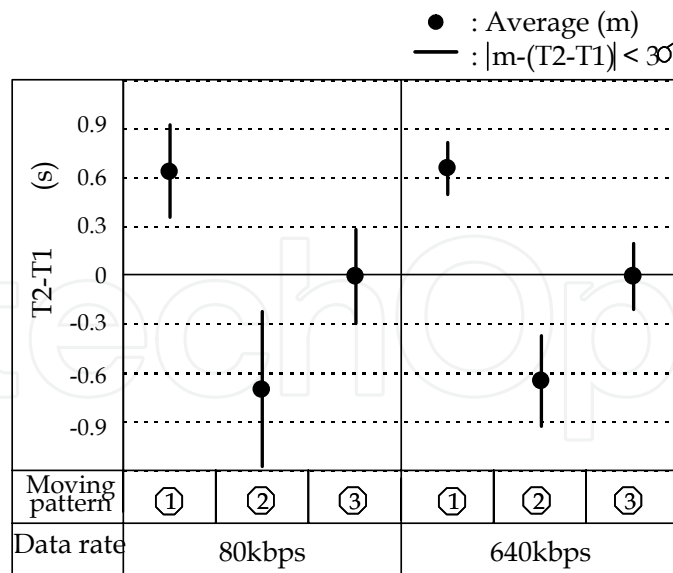

Fig. 12. Measurement results of (T2-T1)

4.2 Estimation of the tag moving speed

The detail performance of Method Moreover, the speed of movement can be also estimated by measuring the time difference T2-T1 because the distance between two antennas is fixed.

Figure 13 shows the measurement results of the movement speed.

Variation of measurement results in the case of $v=2\text{m/s}$ is larger than in other cases because the precise speed is inversely proportional to the speed of movement of the measurer. Figure 13 shows that this method can estimate not only the tag direction but also the speed of movement. It is very useful to set the threshold Th of movement speed as the decision criteria in order to increase the accuracy. For example, when the threshold Th_1 and Th_2 are set to -3.5 and 3.5 respectively, it is possible to eliminate abnormal movement such as turning in Fig.13.

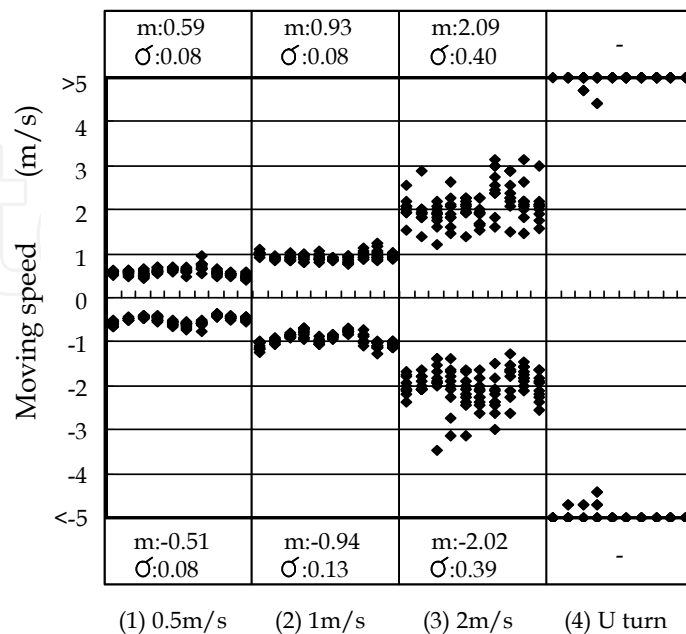

Fig. 13. Measurement results of moving speed

4.3 Effect of the orientation of the tag

Generally, a tag are used a liner polarized dipole antenna in consideration of read range and cost. In this case, the read performance in reader depends on the orientation of the tag. The tag movement detection results of the time difference T_2-T_1 in three cases is shown in Fig.14.

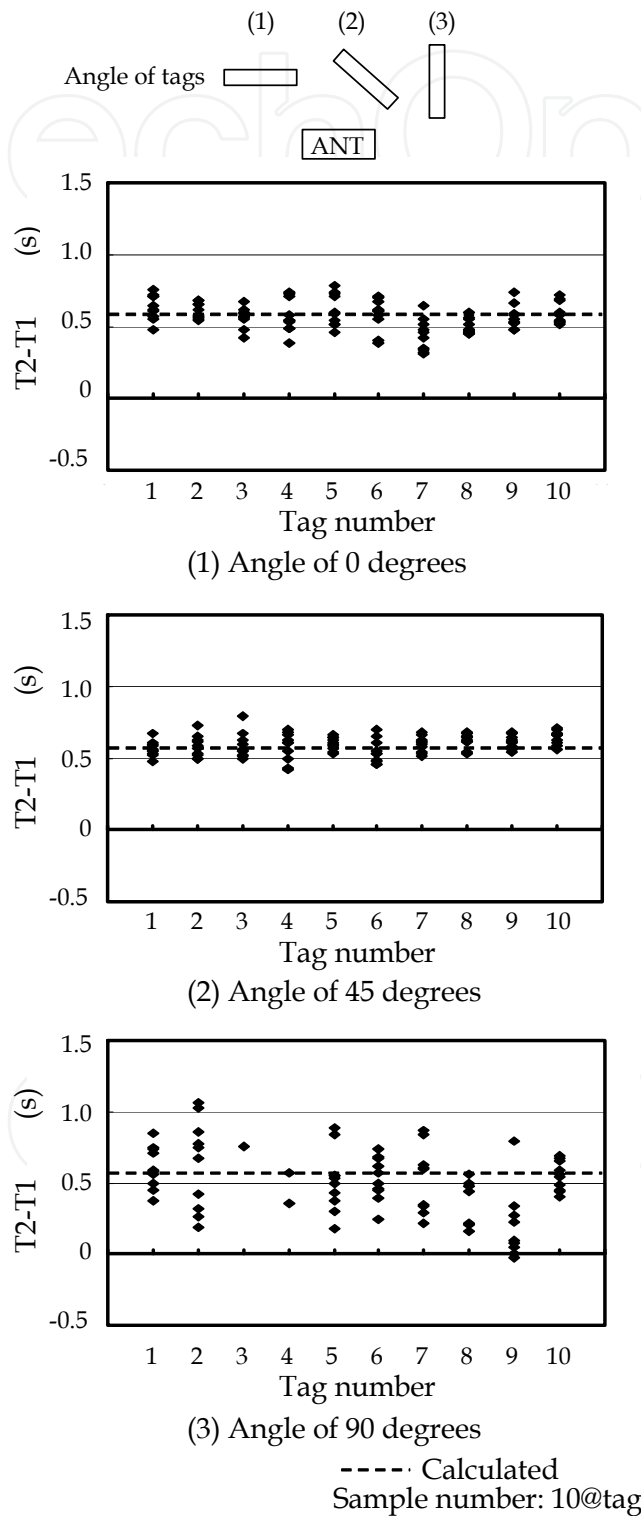

Fig. 14. Different time between two antennas

T2-T1 of the tags that have 90 degrees angle against the reader antenna ((3) in Fig.14) varies widely because they are hard to be read. The percentage of read in this case was 79% and the accuracy among tags to be read was 95%. However, when tags set 45 degrees angle, the movement direction of tags can be detected with as high accuracy as a parallel case ((1) in Fig.14). In other words, it is useful to tilt two antennas of the reader in place of tags.

4.4 Effect of the intersection of the tags

In actual cases, it may happen that two tag groups pass through in the opposite direction individually and simultaneously. The measurement results in that case are shown in Fig.15.

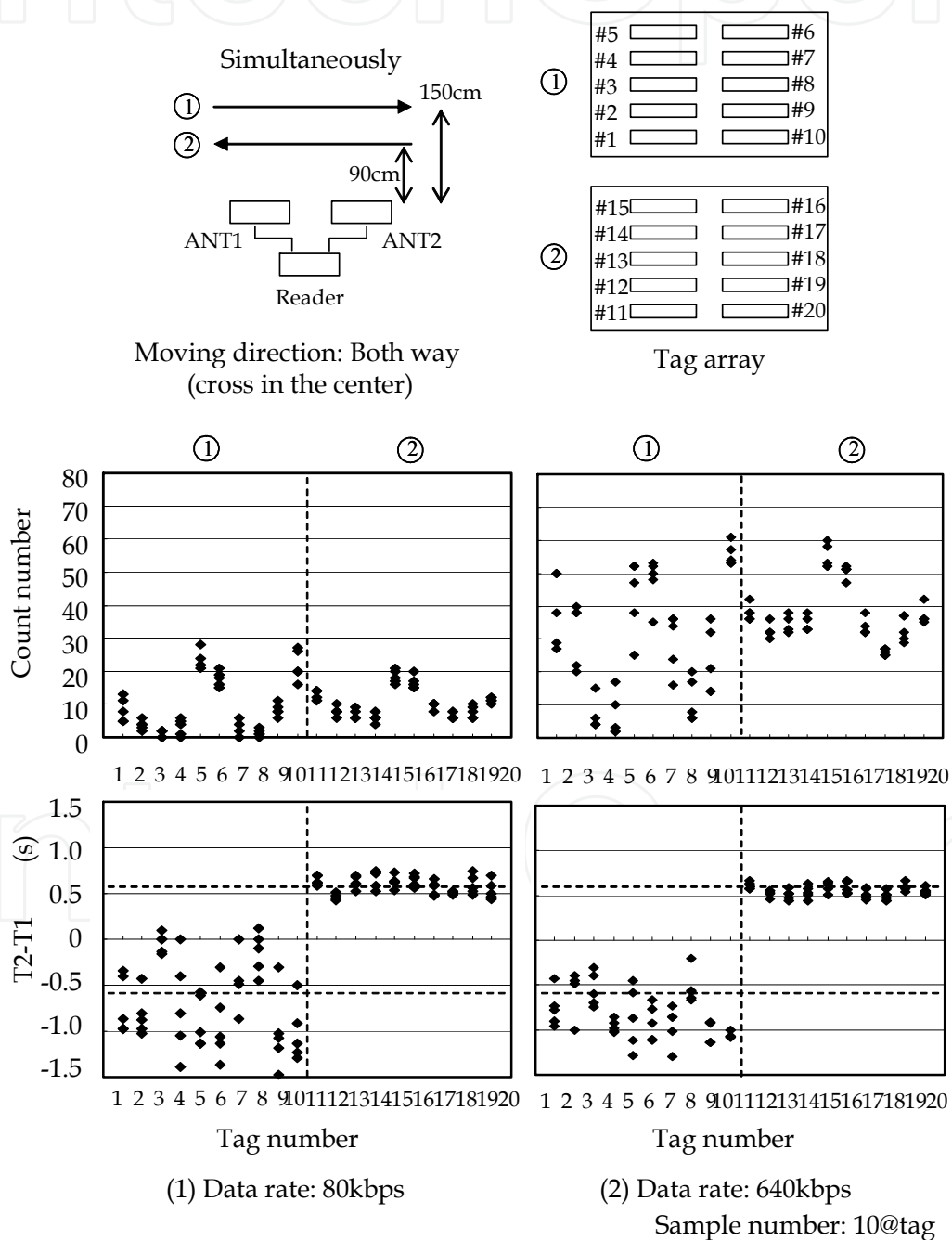

Fig. 15. Measurement results in simultaneous cross moving

One tag group (#1-#10) passed through from antenna 1 to antenna 2, and the other group (#11-#20) passed through in the opposite direction behind the former group. Tag group (#1-#10) has the same characteristics as in Fig.11. However, tag group (#11-#20) is strewn widely because the radio wave is blocked by the other tag group in passing in front of the reader antenna. In the case of 80kbps data rate, 14% of this tag group could not be read and around 5% among all the read tags made an error (that is, the accuracy was about 95%). However, when the data rate is 640kbps, both of the read rate and the accuracy are 100%. Therefore, this method is useful because the tag moving direction can be detected correctly by increasing the data rate even if the most severe case like intersection in front of the antenna.

5. Conclusion

In this chapter, a method for precisely estimating the tag movement direction in an RFID gate system was proposed. This method uses the time difference between two antennas of the reader. This method has the advantage of being able to judge tag direction individually even when there are some tags moving to the reverse direction. Especially, when it uses the proposed algorithm of the weighted center of passing time, the precision of the estimation can be increased. Finally, the feasibility of the method was proved by measurement results.

6. References

- [1] "Metro Future store" <http://www.rfidjournal.com/article/view/889>
- [2] H. Ochi, S. Tagashira and S. Fuita, "A localization system for wireless sensor networks," IPSJ SIG Tech. Rep., ARC-160, pp.17 22, Dec.2004
- [3] T. He, C. Huang, B. John, A. Stankovic and T. Abdelzaher, "Range-free localization schemes for large scale sensor networks." Mobicom, September 2003, pp.81 93
- [4] J. Hightower, G. Borriello and R. Want, "SpotON: an indoor 3D location sensing technology based on RF signal strength" UW CSE Tech. Report #2000-02-02, February 2000
- [5] L. Ni, Y. Liu, Y. Lau and A. Patil, "LANDMARC: indoor location sensing using active RFID" Wireless Networks 10, pp.701 710, Kluwer Academic Publishers, Netherlands, 2004
- [6] T. Yoshikawa, "Radio engineering B," Tokyo Denki University
- [7] P. Wilson, D. Prashanth and H. Aghajan, "Utilizing RFID signaling scheme for localization of stationary objects and speed estimation of mobile objects" International conference on RFID, pp.94 99, March 2007
- [8] Y. Oikawa, "UHF IC tag and reader/writer products" NEC Tech. Journal, vol.2, No.4, pp.76 80, December 2007
- [9] Y. Kawakita, J. Mitsugi, O. Nakamura and J. Murai, "Acceleration of UHF-band RFID inventory leveraging capture effect." IEICE, vol.J91-B, No.10, pp.1279 1286, October, 2008



Current Trends and Challenges in RFID

Edited by Prof. Cornel Turcu

ISBN 978-953-307-356-9

Hard cover, 502 pages

Publisher InTech

Published online 20, July, 2011

Published in print edition July, 2011

With the increased adoption of RFID (Radio Frequency Identification) across multiple industries, new research opportunities have arisen among many academic and engineering communities who are currently interested in maximizing the practice potential of this technology and in minimizing all its potential risks. Aiming at providing an outstanding survey of recent advances in RFID technology, this book brings together interesting research results and innovative ideas from scholars and researchers worldwide. *Current Trends and Challenges in RFID* offers important insights into: RF/RFID Background, RFID Tag/Antennas, RFID Readers, RFID Protocols and Algorithms, RFID Applications and Solutions. Comprehensive enough, the present book is invaluable to engineers, scholars, graduate students, industrial and technology insiders, as well as engineering and technology aficionados.

How to reference

In order to correctly reference this scholarly work, feel free to copy and paste the following:

Yoshinori Oikawa (2011). Tag Movement Direction Estimation Methods in an RFID Gate System, *Current Trends and Challenges in RFID*, Prof. Cornel Turcu (Ed.), ISBN: 978-953-307-356-9, InTech, Available from: <http://www.intechopen.com/books/current-trends-and-challenges-in-rfid/tag-movement-direction-estimation-methods-in-an-rfid-gate-system>

INTECH
open science | open minds

InTech Europe

University Campus STeP Ri
Slavka Krautzeka 83/A
51000 Rijeka, Croatia
Phone: +385 (51) 770 447
Fax: +385 (51) 686 166
www.intechopen.com

InTech China

Unit 405, Office Block, Hotel Equatorial Shanghai
No.65, Yan An Road (West), Shanghai, 200040, China
中国上海市延安西路65号上海国际贵都大饭店办公楼405单元
Phone: +86-21-62489820
Fax: +86-21-62489821

© 2011 The Author(s). Licensee IntechOpen. This chapter is distributed under the terms of the [Creative Commons Attribution-NonCommercial-ShareAlike-3.0 License](#), which permits use, distribution and reproduction for non-commercial purposes, provided the original is properly cited and derivative works building on this content are distributed under the same license.

IntechOpen

IntechOpen