

We are IntechOpen, the world's leading publisher of Open Access books Built by scientists, for scientists

4,700

Open access books available

121,000

International authors and editors

135M

Downloads

Our authors are among the

154

Countries delivered to

TOP 1%

most cited scientists

12.2%

Contributors from top 500 universities



WEB OF SCIENCE™

Selection of our books indexed in the Book Citation Index
in Web of Science™ Core Collection (BKCI)

Interested in publishing with us?
Contact book.department@intechopen.com

Numbers displayed above are based on latest data collected.
For more information visit www.intechopen.com



Electrodeposited Copper Oxide and Zinc Oxide Core-Shell Nanowire Photovoltaic Cells

Dante DeMeo, Samuel MacNaughton,
Sameer Sonkusale and Thomas E. Vandervelde
Tufts University
USA

1. Introduction

Uncertainty in energy capacity, limited fossil fuel resources, and changes in climate predicate a need for increased research and development into alternative and sustainable energy solutions. Solar energy is one solution to this problem and many variations of it exist; however, the majority of them are prohibitively expensive. We propose a low-cost solar energy generation method which is cost-effective both in materials and production. Our solution will utilize cheap, abundant materials as well as lower-cost fabrication methods to produce photovoltaic (PV) cells. Although it is unlikely that the efficiency of such cells will be record-breaking, its low cost should make its price-per-watt-produced competitive, which is one of the most important metrics for the commercialization of any solar technology.

Our design consists of a radial heterojunction comprised of p-type copper oxide and n-type zinc oxide nanowires, which are oxides of earth-abundant materials. The nanowires have a core-shell design to minimize carrier travel distance and maximize junction area. Furthermore, we utilize a wet chemistry fabrication process, making the production of such cells inexpensive, easily scalable and non-demanding in terms of fabrication energy. The process involves growing copper nanowires, oxidizing, plating zinc oxide, and depositing a top contact.

2. The case for solar

Solar energy is an attractive solution to demanding energy problems because of the amount of energy it can produce, its low maintenance and operating costs, and its clean nature. The sun has the ability to provide more than enough energy to satiate the world's demands, even accounting for future growth. Once in place, solar panels will continue to provide electricity for decades with minimal human interaction; systems can still operate after 40 years (King, Quintana et al. 2000) and have the potential to last even longer. There are no fuel costs or harmful pollutants during operation, and setup needs only little training.

The amount of energy coming from the sun is greater than any other form of renewable energy. Solar radiation accounts for 173,000 TW of energy, dwarfing all other renewables such as wind and waves at 3600 TW, geothermal energy at over 32 TW, and tidal energy at 3

TW (Da Rosa 2005). Although these numbers do not reflect the amount of electricity able to be produced from their respective sources of energy, it does demonstrate a clear dominance of solar over all other forms of energy.

Solar energy has the potential to supply all of the worlds power needs as demonstrated by Figure 1. If the six black circles were covered in solar panels of only 8% efficiency, 18 TW of energy could be produced (Loster 2010), which is more than the total energy consumption in 2007 of 16.6 TW (U.S. Energy Information Administration 2010). The total land area needed is approximately 910,000 sq. km. (Loster 2010) or about 0.6% of the total land area on earth. It should be noted that many solar cell designs which exceed 8% conversion efficiency have been produced. (Green, Emery et al. 2010)

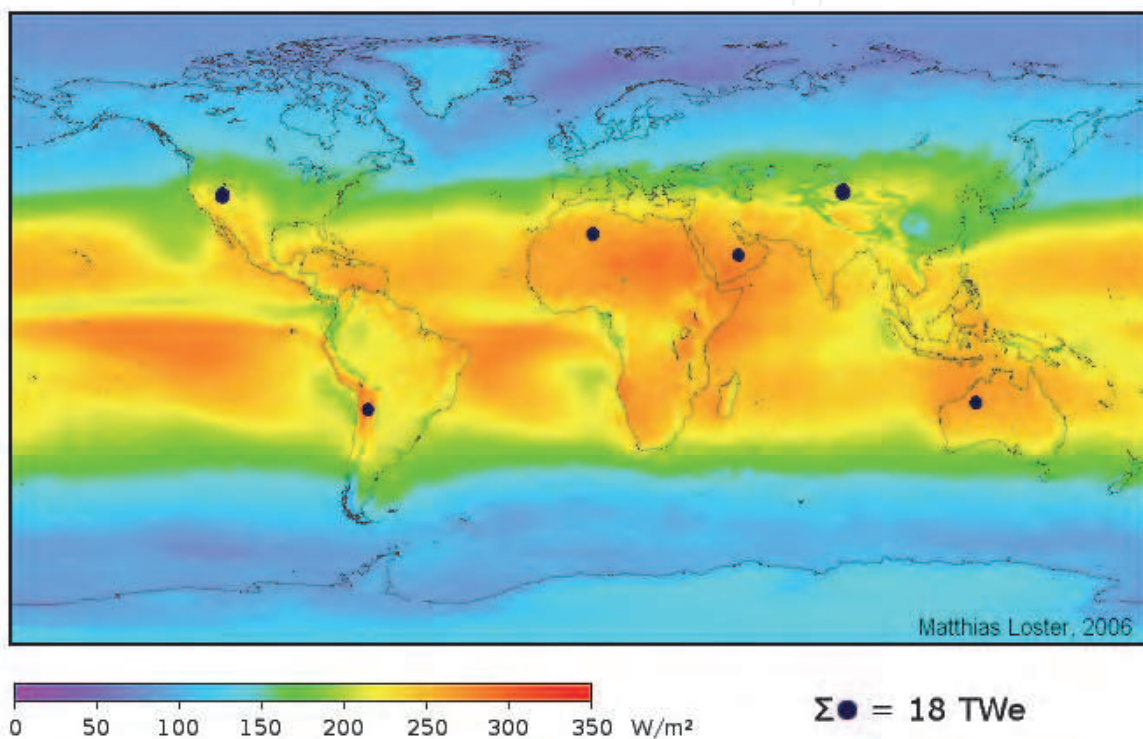

Fig. 1. "Sunlight hitting the dark disks could power the whole world if installed in areas marked by the six discs in the map, solar cells with a conversion efficiency of only 8% would produce, on average, 18TW electrical power. That is more than the total power currently available from all our primary energy sources, including coal, oil, gas, nuclear, and hydro. The colors show a three-year average of solar irradiance, including nights and cloud coverage." (Loster 2010)

Although solar photovoltaics have a substantial up-front cost, the operation and maintenance costs are minimal. Since solar cells are solid-state devices and have no moving parts (except in the case of tracking systems), they are highly reliable.

Photovoltaics generate no harmful emissions during use, nor do they produce any noise or unwanted by-products. (Luque and Hegedus 2003) This clean quality as well as the highly modular and scalable nature of the technology makes it an excellent choice for a myriad of power systems. Solar panels can be used by households to provide energy for one's home, for off grid remote power generation, or for large-scale utility plants. Outside of the manufacturing process, solar panels are very environmentally friendly and do not contribute

CO₂ to the atmosphere. Utilizing end-of-life recycling and more benign industrial processing will make the technology even more environmentally friendly in the future.

2.1 Solar cell basics

Solar photovoltaic cells are devices which turn radiant energy from the sun directly into electricity. Factors which affect the amount of energy created include the intensity of radiation, the spectral distribution of the radiation, and the specific materials, design, and quality of the solar cell at hand. Most inorganic solar cells, however, work in the same manner and will be described presently.

Electromagnetic radiation (primarily in the visible and near-infrared regions of the spectrum) is emitted from the sun and absorbed by the solar cell. A photon will then excite a negatively charged electron from the valence band (low energy state) to the conduction band (a higher energy state) leaving behind a positively charged vacancy, called a hole. For this energy transfer to create any usable energy, the photon must have an energy greater than the band-gap of the material, or else the electron will immediately relax down and recombine with the hole and the energy will be lost as heat. Upon excitation above the bandgap the photon creates an electron and a hole which are now free to move throughout the semiconductor crystal. These act as charge carriers which transport the energy to the electrical contacts, which results in a measurable external current. These processes are shown in Figure 2.

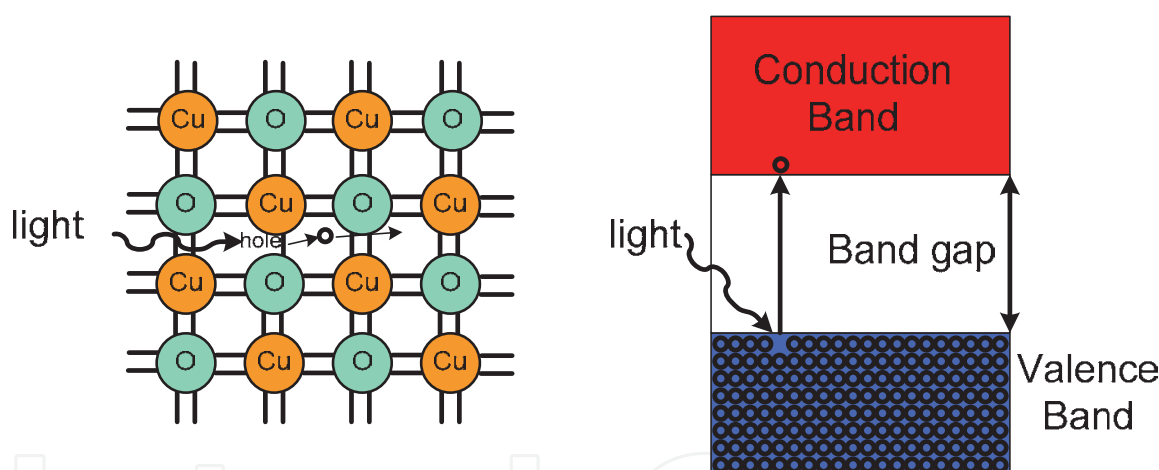

Fig. 2. (Right) A photon excites an electron (black circle) from the valence band to the conduction band. (Left) Each black line represents a valence electron in a covalent bond. When a photon breaks one of these bonds, a free electron and a hole are created.

The materials and structure of the solar cell are very important in this process. A solar cell is made out of semiconductor material which facilitates the creation and motion of charge carriers. The specific material determines the band-gap and thus which wavelengths of light the cell can absorb, as well as many other optoelectronic properties¹. Once the electron-hole

¹ For more information on optoelectronic properties of materials, one may refer to virtually any relevant textbook on the subject. Several recommended texts include: Kasap, S. O. (2001). *Optoelectronics and Photonics Principles and Practices*. Upper Saddle River, New Jersey, Prentice-Hall Inc., Kasap, S. O. (2006). *Principles of Electronic Materials and Devices*. New York, McGraw-Hill., and Saleh, B. E. A. and M. C. Teich (2007). *Fundamentals of Photonics*. Hoboken, New Jersey, John Wiley & Sons.

pair is created from incident sunlight, the solar cell must separate these charges or else they will quickly recombine and lose their energy. To do this, two layers of semiconductor are used: an n-type, which has an excess of fixed negative charges, and a p-type, which has an excess of fixed positive charges. When these two semiconductor layers are placed next to each other, opposing charge carriers self-annihilate in the region of the junction. The remaining fixed charges cannot move to recombine and thus create a built-in potential to the junction. This potential causes the charges to separate and move toward the contacts. If the electrons and holes survive long enough, then the solar cell can generate energy. This process can be seen in Figure 3, where light creates electron-hole pairs which are then carried towards the contacts due to the voltage difference between the n and p layers. Due to the opposite polarity of the different charge carriers, even though they travel in opposite directions, their currents add in the same direction.

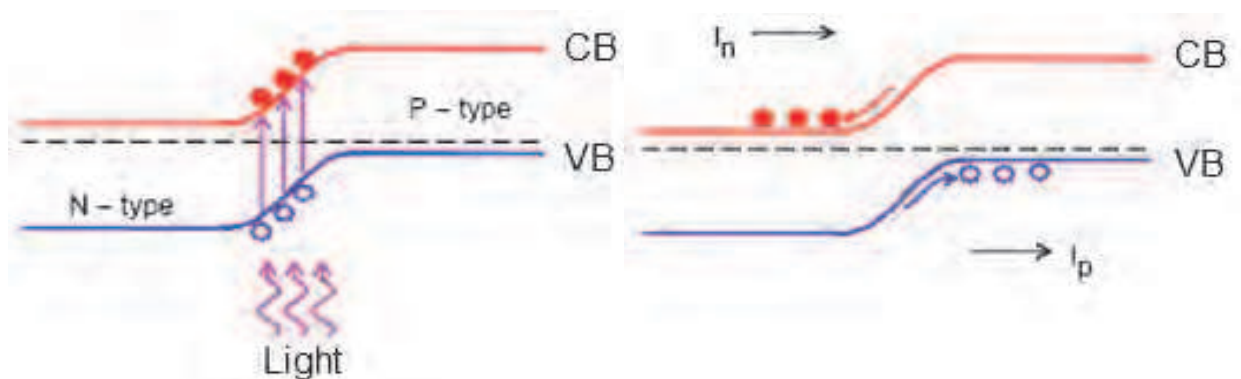

Fig. 3. Charge separation in a solar cell. The red circles are electrons, and the blue circles are holes. CB stands for conduction band, and VB stands for valence band. Note that although the electrons and holes travel in opposite directions, since they have opposite polarities, their currents, denoted as I_n and I_p , add in the same direction

The band-gap presents a distinct trade-off in the performance of a material in a solar cell device. A wide band-gap material does not absorb the energy of lower-energy photons. A small band-gap material may absorb more solar energy; however, the photo-generated charge carriers lose much of this energy due to thermalization down to the band-gap energy as the electrons travel out of the material. This is illustrated in Figure 4. Thus, regardless of the bandgap, a significant portion of solar energy is lost. As discussed in the following section, a nanowire array has the potential to resolve this issue, vastly increasing the maximum efficiency of the photovoltaic (Kempa, Naughton et al. 2009).

The ultimate figure of merit for solar cells is cost per watt; this decides whether a particular solar energy technology will become commercially viable. Our use of almost exclusive wet chemistry and abundant materials has the potential to be incredibly cheap and created on a massive scale. Solar energy has the potential to accommodate much of the world's energy needs, but for it to actually become a major source of energy the materials used must be in sufficient supply. The materials we present are abundant enough to provide electricity for the entire world (Wadia, Alivisatos et al. 2009). This abundance, when combined with the inexpensive mass manufacturing possibilities of the wet chemistry process, indicates that this device could help achieve energy independence while safeguarding our environment.

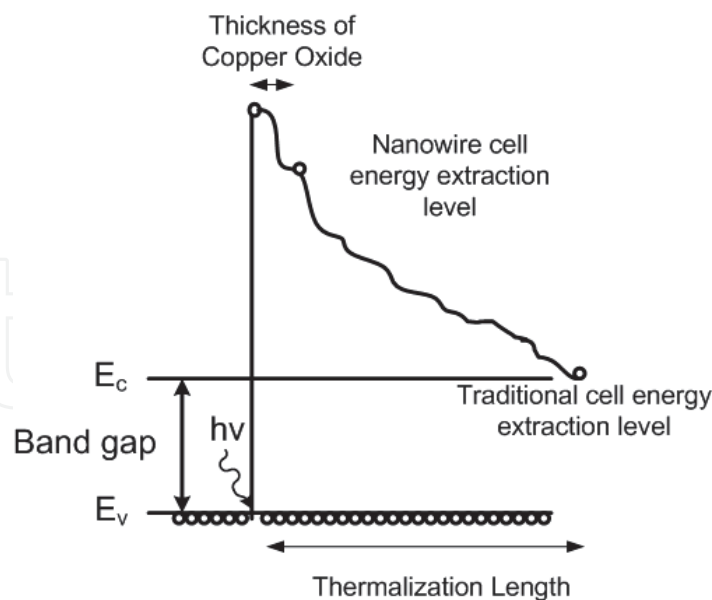

Fig. 4. Thermalization loss in a solar cell. E_c stands for conduction band energy level, and E_v stands for valence band energy level.

Our design focuses on the use of cheap, abundant materials, as well as inexpensive fabrication methods in order to drive down the cost of producing solar cells. The use of a nanowire geometry should help to increase absorption, as well as decrease the carrier travel distance. Details of our design and the benefits therein will be discussed in the following sections.

2.2 How nanowires benefit solar cells

Nanostructures are constantly being found to improve the performance of objects and devices in many different fields, including photovoltaics. Specifically, nanowires are being used to enhance solar cells and have several key benefits including: decreased net reflectance (increased absorbance), increased junction area, and decreased carrier travel distance.

The increased surface area of a nanowire array and the inherent surface features result in decreased reflection and consequently higher absorption of incident light. (Hu and Chen 2007) This is largely due to light trapping and scattering effects where light gets reflected in between the nanowires, thus largely reducing the likelihood that it will be reflected outwards. This effect is shown in Figure 5 and is explained in more detail in reference (Muskens, Rivas et al. 2008). Reference (Cao, Fan et al. 2010) demonstrates resonant effects based on nanowire diameter and the weak angle dependence of incident light inherent in nanowires which contribute to increased absorption.

The nanowire core-shell geometry causes carriers to travel radially across the wire, thus reducing the distance the carrier must travel before it can reach the contact. The junction is also close to the contacts due to the nanowires, thus the separated carriers have a shorter distance to travel within the semiconductor and consequently a lower likelihood of recombining. Additionally this also means that the material quality can be lower than a traditional device (Tian, Zheng et al. 2007), an important factor with our material and growth procedures. We are examining the carrier transport mechanisms in these photovoltaic cells to see if the decreased carrier travel distance caused by the lateral movement reduces carrier extraction times. This may lead to increased energy extracted per photon, as hot carriers could be extracted before they lose their above-bandgap energy to thermalization.

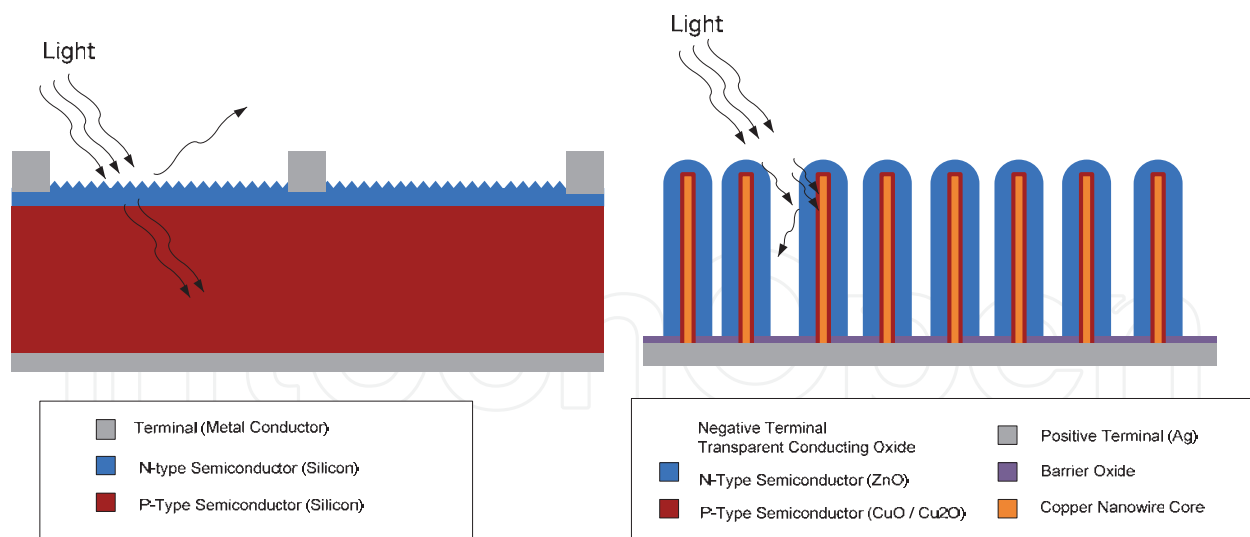

Fig. 5. Bulk solar cell and nanowire solar cell, notice the light trapping effect of the nanowire cell.

The core-shell nanowire array allows for the use of ultrathin semiconductor layers, which reduce the amount of material used, while not sacrificing photon absorption. Although the materials used here are good absorbers already, Figure 6 demonstrates how the nanowires greatly improve light absorption. Since absorption is high while using ultrathin layers, the added benefit of reducing the amount of material used will lower overall costs of the design.

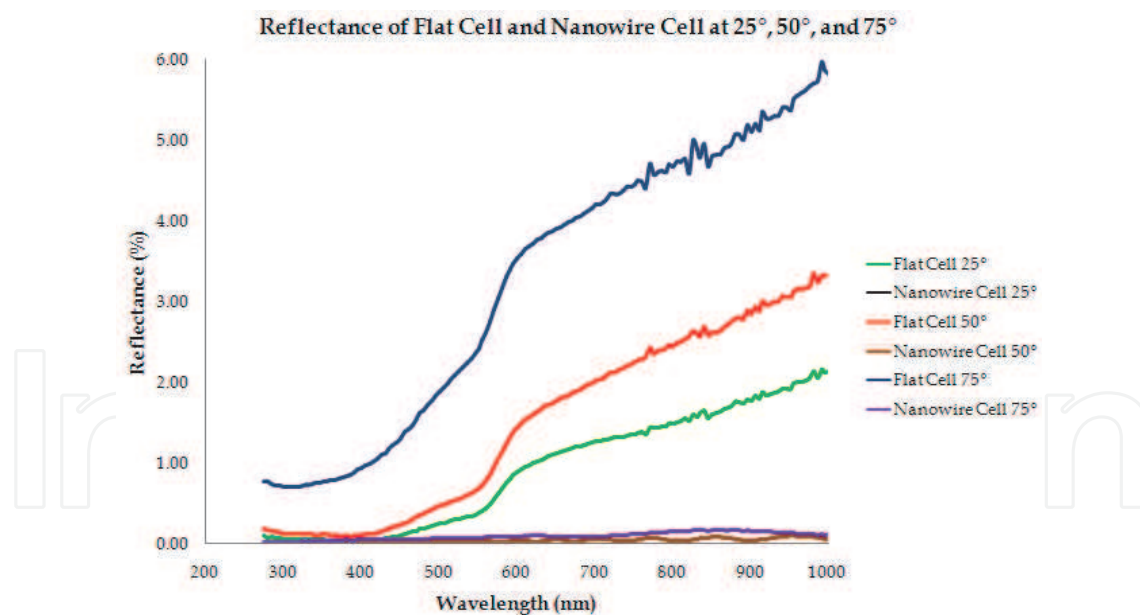

Fig. 6. Reflectance measurements for nanowire and flat cell structure at multiple angles with 45° polarized light. Measurements were taken on a JA Woollam VASE ellipsometer. The black indicating the nanowire cell at 25° is mostly obscured by the axis and other lines. The nanowire cell at 25° resulted in the least amount of reflection.

Yet another benefit to the core-shell geometry is that no matter where the photon is absorbed, it will be close to the junction. So if a photon travels halfway down a wire before being absorbed, or is absorbed at the tip of the wire, it has a similar likelihood of creating an electron-

hole pair. In a bulk cell this is not the case as the further into a cell the photon travels, the further it is from the junction and the less likely it is that it will contribute to carrier generation.

3. Nanowires and their fabrication

Due to their geometry and scale, nanowires have generated massive research interest in the recent decades. Nanowires demonstrate exceptional surface to volume ratios, which increase inversely with the diameter of the nanowire. Carbon nanotubes have surface to volume ratios exceeding $10^6 \text{ cm}^2/\text{cm}^3$. As such, nanowires have attracted much attention in the realms of catalytic science, energy storage, and electrochemistry; however, nanowire applications for energy generation are less forthcoming.

Many processes have been developed to fabricate nanowires. In general, 'bottom-up' methodologies are employed because 'top-down' techniques are limited in the achievable critical dimension and aspect ratios.

The technique of electrospinning forms nanofibers by taking advantage of the repulsive electrostatic forces present in a charged droplet of fluid. In the right conditions, a charged droplet can effuse a nanoscale stream that forms into a nanofiber. Composites may be used such that further processing can yield nanowires composed of metal or other materials (Shui and Li 2009).

Exceptionally high aspect ratio nanowires can also be grown along the step edges found in natural or manufactured structures. Zach et al. have demonstrated the ability to selectively electroplate at the atomic step edges of highly ordered pyrolytic graphite (Zach, Ng et al. 2000). Similarly, Menke et al. pioneered nanowire fabrication by electroplating along the undercut region of photoresist after wet etching an electrode masked by a lithographically-patterned photoresist film (Menke, Thompson et al. 2006).

Single-crystal semiconducting nanowires can be grown by the vapor-liquid-solid method (VLS growth). This popular method involves depositing a thin (1-10nm), often gold, seed layer on a substrate of the desired nanowire material. The substrate is then put into a vacuum chamber into which appropriate vapor-phase precursors for the material to be grown are introduced. The seed layer forms nucleation points that, at certain temperatures, facilitate the transfer of vapor species through the liquid phase to condensation on the substrate below the gold (Givargizov 1975).

Nanowires can also be fabricated by solution based processing. This is analogous to VLS growth except occurring in a solution rather than a vacuum chamber. In general, a catalyzing agent at the tip of the growing nanowire aids the transfer from ionic species in solution to solid species in the nanowire. Other components in solution inhibit growth on the substrate and sidewalls of the nanowire (Wang, Dong et al. 2006). Also of note is the similar polyol synthesis method (Sun, Mayers et al. 2003). This method involves the passivation of all but one crystal plane, allowing for the single dimensional growth along one crystal plane. High aspect ratio silver, gold, and palladium nanowires have been synthesized in this manner.

Standard lithography may also be used to create nanowires. However, the critical dimension (diameter) and aspect ratio are limited by the technology. The aspect ratios and dimensions achieved by the aforementioned techniques far outmatch those used in standard lithographic processes. However, the use of lithography does present two distinct advantages when dealing with electronic devices. For one, the nanowires can be easily integrated into other devices and structures that are fabricated by lithographic methods. For example, interconnects, transistors, and MEMS structures can be made together with nanowires. Secondly, for standard top-down fabrication methods, there exist many well-

characterized means to make electrical connections with the outside world (wirebonding, solder bumping, etc). This is often an issue when working with bottom-up methodologies. Finally, templated growth is a popular and versatile nanowire production method. This process is used in this work to fabricate core-shell nanowires. In this method, nanowires are masked by a template such as an anodized alumina membrane or a track etched polycarbonate membrane. Both of these membranes have extremely high aspect ratio pores. Anodized aluminum oxide (AAO) membranes have pores that range from nanometers to microns in diameter and up to hundreds of microns in length. To make nanowires, the desired material is filled into the template. A variety of methods have been used to achieve this including atomic layer deposition, centrifugation, electrophoretic deposition, and, most commonly, electrochemical deposition (ECD) (Cao and Liu 2008). In electrochemical growth a conductive seed layer is deposited on one side of the template, and the other side is introduced to a plating solution for the desired material. The final step in fabrication is the removal of the template, which is accomplished by dissolving the membrane in an appropriate solution (halogenated solvents for polycarbonate membranes or strong bases for AAOs).

3.1 Copper oxide - zinc oxide heterojunction nanowires:

The materials investigated here are copper (II) oxide and zinc oxide. These have bandgaps of 1.2 eV (Jiang, Herricks et al. 2002) and 3.3 eV (Ozgur, Alivov et al. 2005), respectively. There is a fair amount of copper (I) oxide present as well which has a band-gap of 2.0 eV (Rakhshani 1986), but this material should decrease with optimization of our fabrication process. These materials were chosen for their ease of use in electrodeposition and their relative abundance. They have the added benefit of being natural n and p type materials. Undoped zinc oxide has a residual n-type conductivity (Look, Hemsley et al. 1999; Ozgur, Alivov et al. 2005), and CuO is naturally p-type. (Jiang, Herricks et al. 2002) Currently an indium tin oxide (ITO) thin film is used for the top contact, but future work will include investigating more economical alternatives.

The structure of the nanowire consists of co-axially stacked layers creating a core-shell arrangement as seen in Figure 7. The benefits of the structure have been discussed in section 2.2. The base and core of the nanowires consist of a copper core, which acts as the bottom contact, next is a shell of copper oxide around the copper core, and then a second shell of zinc oxide. Finally, a layer of indium tin oxide is deposited on the top. Due to the sputtering deposition, this top layer is not very conformal and covers mostly the top of the wires. This process can be replaced by an ALD deposition to achieve a conformal coating.

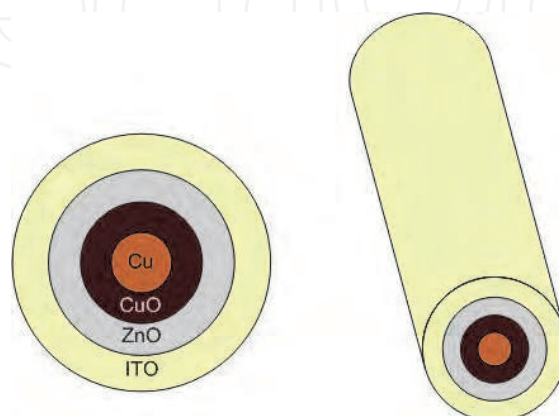

Fig. 7. Core-shell diagram

The band diagram of the cell can be seen in Figure 8. This shows the band-gaps of the materials and the voltage drop between them. This voltage drop is what pushes the electrons and holes away from each other to prevent them from immediately recombining. The band-gap of ZnO is 3.3eV and as such can absorb only UV light out to 376nm. Cuprous oxide (Cu_2O) can absorb light out to 620nm, and cupric oxide, CuO, can absorb radiation out to 1033nm. This encompasses the vast majority of the solar spectrum. The ZnO layer is very thin and has a wide band-gap. Therefore its purpose is to act as the n-type material to create the built in voltage of the diode, which serves to extract charge carriers. The copper oxides serve as the absorber and p-type material in the diode.

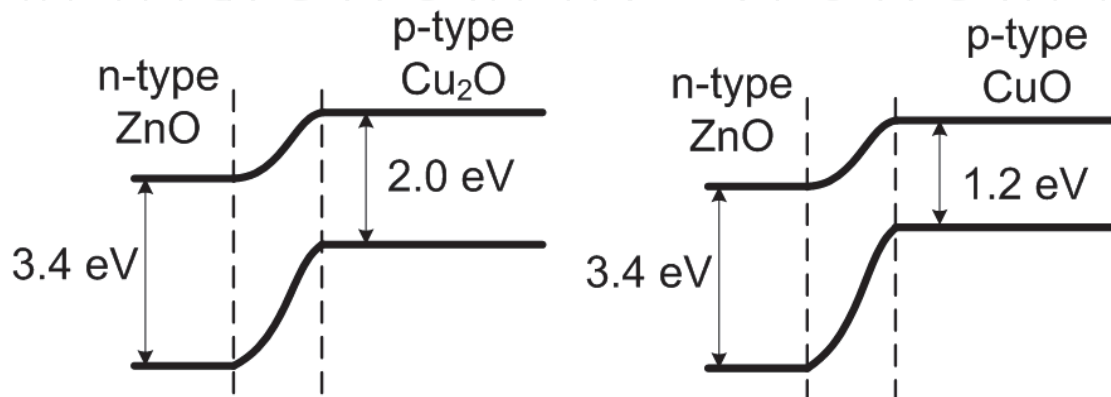

Fig. 8. Band-structure for both copper oxides present.

The process of creating our nanowires will be discussed in section 3.3, however the latest iteration (before top contact deposition) can be seen in Figure 9.

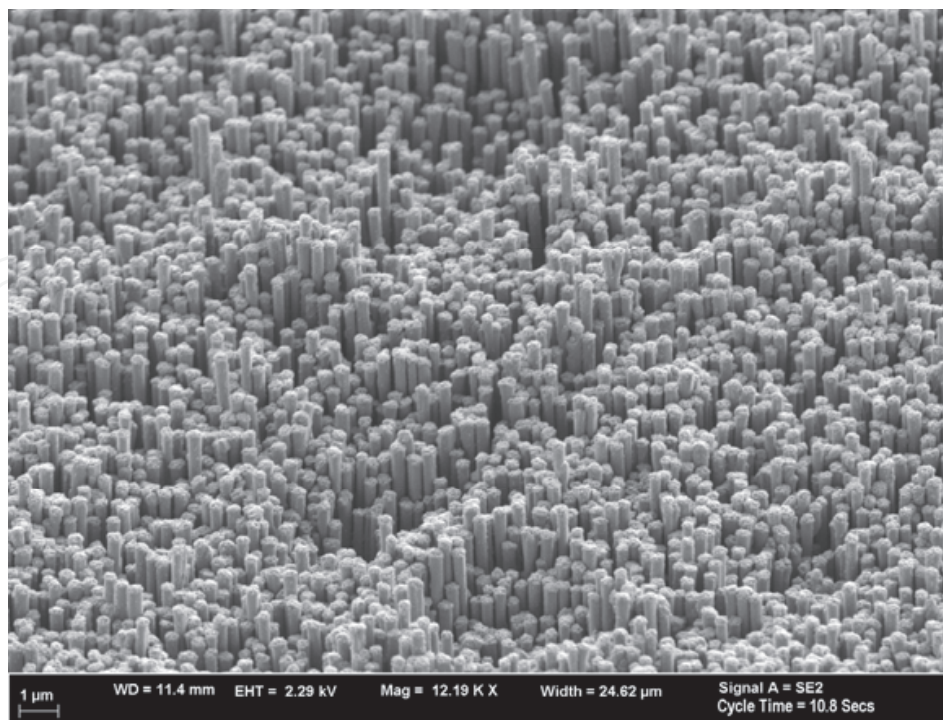

Fig. 9. SEM image of our latest iteration of core-shell nanowires

3.2 Electrochemical and other fabrication methods for nanowire arrays

The geometric constraints when fabricating nanowires (especially core-shell structures) make the use of many common top-down techniques impractical. The dimensions of nanowires place constraints on fabrication with which many conventional deposition methods cannot comply. For example, physical vapor deposition (PVD) processes are line of sight methods, and, as such, these methods never yield impressive step coverage in high aspect ratio (length to width ratio) features such as nanowires (Madou 2002). Chemical vapor deposition performs better and is routinely used to coat or fill features with aspect ratios of five or ten (Gordon, Hausmann et al. 2003). However, this is still orders of magnitude removed from the typical nanowire aspect ratios. The following section details fabrication methods well-suited to the creation and alteration of nanowire arrays with special attention to copper and zinc oxides and core-shell structures.

Electrochemical deposition, shown in Figure 10, is the utilization of electrically driven redox reactions to solidify ions out of solution. Most often, metallic cations are reduced at a cathode, while oxidation at an anode of the same metal replaces the reduced ions. It is possible to plate alloys and compounds through careful manipulation of the plating bath. For example, many metal oxides, including copper and zinc oxides, can be deposited by careful control of the solution and electrical conditions (Golden, Shumsky et al. 1996)

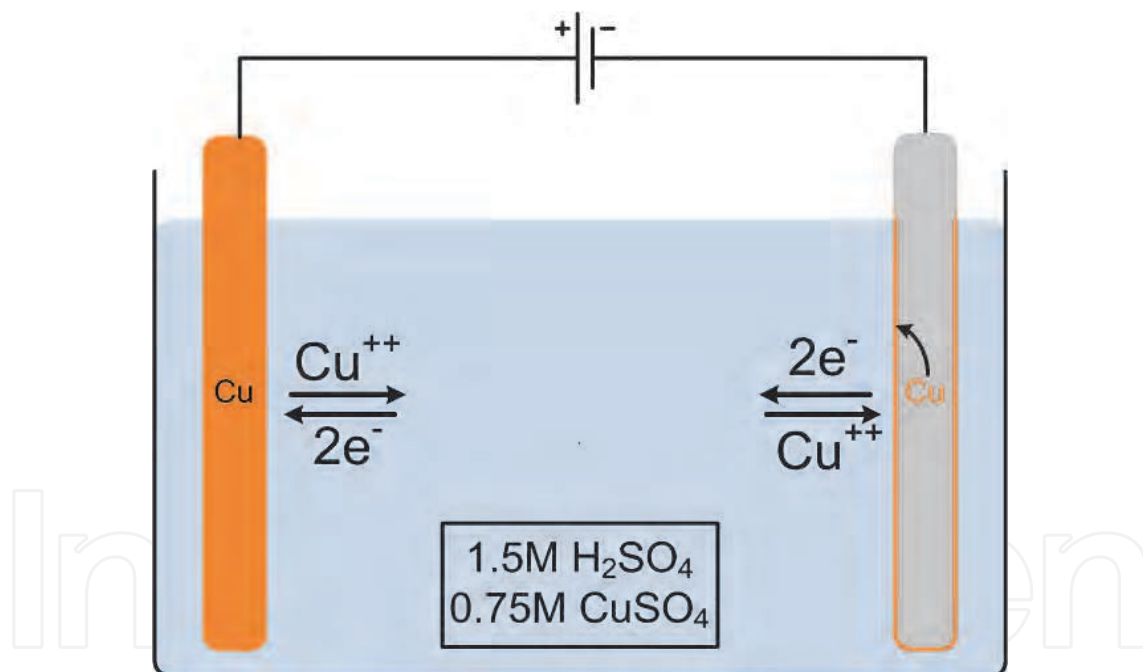

Fig. 10. Mechanism of electrochemical deposition

One drawback of electro-deposition is its tendency towards non-conformal growth on non-planar surfaces. This is not an issue when growing nanowires through a template, which serves to constrain the growth. However, on rough or textured surfaces (such as a nanowire array), electrons gather in the asperities on the surface. More deposition occurs at these points, which only exacerbates the issue as this makes the surface rougher. Additives into the plating bath can alleviate this issue by gathering at the points of highest current density and inhibiting deposition, but this introduces impurities into the deposited material. The power of additives in creating conformal deposits is evidenced by the advent of copper

interconnects in the integrated circuit industry where high-aspect ratio vias are filled by ECD (Andricacos 1999). However, aspect ratios are even more pronounced for the extreme geometries observed in nanowire arrays. There are also mass transfer concerns as the diffusion length for ions in solution exceeds the inter-nanowire spacing. Therefore, it is difficult (or improbable) for ions to travel the length of the nanowire to its base without being reduced and deposited prematurely. While ECD is difficult to implement for conformal coatings on nanowire arrays, it remains the method of choice to make high-quality nanowires through templated growth.

Electroless and immersion deposition are chemical methods to deposit metal films without applying an electric potential and have traditionally been used to conformally coat difficult geometries. Electroless plating (also known as autocatalytic deposition) utilizes reducing agents in solution to drive the reaction at the surface, which acts as a catalyst. Electroless deposition does not suffer from the current crowding effects of electrolytic deposition, but mass transfer effects can influence the deposition rates at different points in a nanowire geometry (Paunovic, Schlesinger et al. 1998).

Immersion plating is the displacement reaction of a more noble metal replacing a more active metal on a surface. For example, gold ions in solution would reduce and plate onto an iron bar. The iron surface would oxidize and dissolve into solution to maintain charge conservation. The reaction is self-limiting with deposits being only a few monolayers thick. Unlike autocatalytic and electrolytic plating, immersion deposits are exceptionally uniform regardless of surface topology. As such, immersion deposits are an attractive option for creating the 'shell' in nanowire core-shell applications. The main drawback is the material limitations: the depositing material must be higher in the galvanic series than the substrate (Langdon 1988).

The material constraints of immersion plating can be solved through a process known as contact plating. In this process, the substrate to be coated is put into electrical contact with a more electropositive (less noble) metal. Oxidation occurs at the electropositive metal, driven by the constituents of the bath. This oxidation yields electrons, which travel through the electrical contact and allow for reduction of ions out of solution. If the less noble metal is also the coating material, this reaction is self-limiting in that the reaction ceases when the work is coated. Thus, conformal coatings of less-noble metals may be electrochemically deposited on difficult geometries (Durney 1984).

While not electrochemical in nature, atomic layer deposition (ALD) should be mentioned as the ultimate method of conformal coating. Unlike the previous processes, ALD occurs from reactants in gas phase, generally at low pressures. In ALD a gas precursor is introduced and allowed to form a monolayer on the surface of a sample before being pumped out. Then, a second gas is introduced, which reacts with the monolayer to yield the desired film. This process is repeated to build up a film atomically, monolayer by monolayer. Because the monolayers are exceptionally uniform, conformal coatings on difficult topologies are easily achieved. Aspect ratios of almost 50 are easily coated uniformly (Ritala and Leskela 2001). The main drawback to ALD is the extremely low rate of deposition, which typically reaches a maximum at a few Angstroms per minute.

Finally, oxidation reactions are perhaps the most facile and effective way of creating exceptionally uniform and conformal layers on complex structures. Oxidation can be performed in either aqueous or gaseous environments. The latter case, generally referred to simply as thermal oxidation, has been well-characterized over a wide-range of temperatures

(Cabrera and Mott 1949). Thin, uniform oxides can be formed on metals simply by applying heat in an oxygen atmosphere (Rusu, Girtan et al. 2007; Njeh, Wieder et al. 2002). However, the high temperatures needed in thermal oxidation can have some undesired effects with regards to annealing, coefficients of thermal expansion, and diffusion. For example, a copper-zinc structure cannot be converted into a copper oxide - zinc oxide heterojunction by thermal oxidation because the materials will diffuse into one another. This forms brass, not a diode. In the case of wet oxidation, the reaction can occur spontaneously (Tam and Robinson 1986) or can be driven electrically in a process known as anodization (Yamaguchi, Yamazaki et al. 1998). These processes have the advantage of taking place at low temperatures. Anodization can be viewed as the reverse process as electroplating. In anodization, a positive potential applied to the piece will cause oxygen ions in solution to oxidize (in the electrochemical sense) atoms at the surface. Whereas, in ECD, the oxidized ions at the anode dissolve into solution, in anodization, the oxides remain at the anode and build up a conformal film. Incidentally, it is by this process that the AAO templates are made for the initial nanowire growth in the process presented in this paper.

3.3 Fabrication

Our fabrication takes place at the Tufts Micro and Nano Fabrication Facility (TMNF) at Tufts University, with some work being done at the Center for Nanoscale Systems (CNS) at Harvard University. TMNF is a class 1000 cleanroom where most of our wet chemical and sputtering processes are performed. CNS is a large 10,000 sq. ft. class 1000 cleanroom where most of our imaging is done. We also perform our atomic layer deposition at CNS as well.

Our fabrication flow process can be seen in Figure 11. This diagram shows the process from start to finish and includes the creation of the copper nanowires, oxidation of the copper oxide layer, deposition of the ZnO layer, and finally the deposition of the top contact layer. The process starts by obtaining an anodized aluminum oxide template which can either be purchased commercially or created by anodizing an aluminum film. Copper is then sputtered on one side of the template become the electrode and act as a seed layer for the nanowires. The AAO then acts as a mask for the through-plating of copper. Five to ten microns of copper is electroplated into the pores. The AAO is then dissolved in a 10% solution of potassium hydroxide (KOH) for 20 minutes, revealing a densely packed copper nanowire array (as shown in Figure 9 above).

The electrochemical deposition (ECD) of copper is performed using a solution of 0.75 M copper sulfate (CuSO_4) and 1.5 M sulfuric acid (H_2SO_4) at room temperature with air agitation. This reaction is current limited with the supplied current at less than or equal to $5\text{mA}/\text{cm}^2$. The zinc oxide ECD is performed using a solution of 0.1 M zinc nitrate (ZnNO_3) at $70^\circ - 80^\circ \text{C}$ at a potential of 0.75 volts.

4. Future research

Nanowires and especially nanowire solar cells are still in an early stage of development and are found almost exclusively in the laboratory, although there are several companies planning products which utilize nanowires, i.e. Bandgap Engineering, QDSoleil, Illuminex. As with so many new technologies, there is much work yet to be done and there are still many improvements, optimizations, and options to be explored in the research presented here. Several areas which require further research and investigation are with conformal coatings of the nanowires and general process optimization, difference material choices, and long-term stability.

CuO / ZnO Solar Cell Fabrication Process

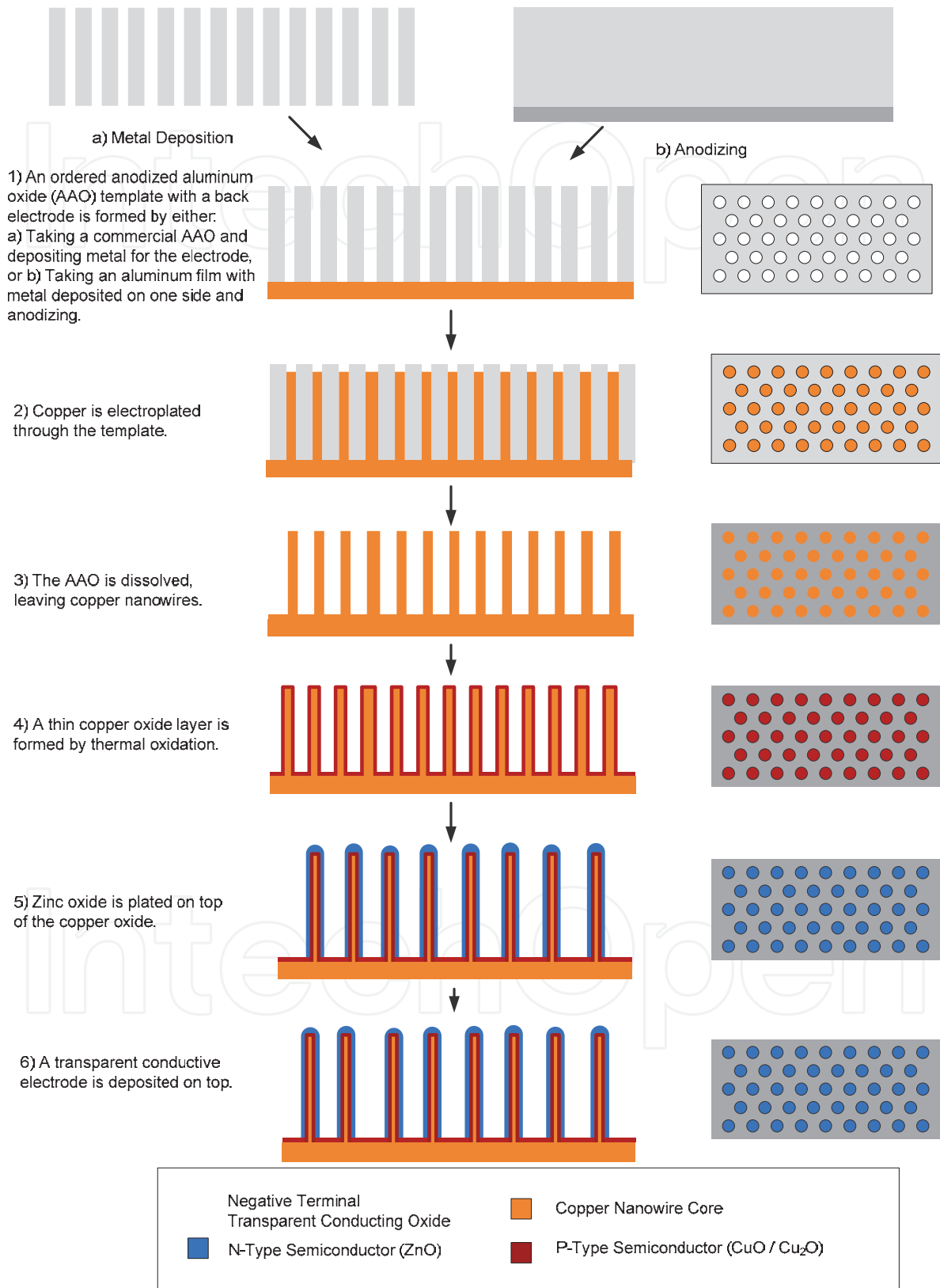

Fig. 11. Fabrication process for core-shell nanowire array photovoltaics

One of the biggest difficulties in growing these core-shell nanowires is achieving conformal coatings to create the core-shell structure. Electrochemical methods, besides being cheap, have proven to be much better than physical vapor deposition techniques, however due to the extremely small distances between the nanowires, often only the upper portions of the nanowires are coated. Several of the ways we are trying to mitigate this problem is by testing to see how atomic layer deposition compares to the ECD process. Also, contact plating shows promise in conformal, electrochemical coating of nanowire geometries. Much of the fabrication process already developed needs further optimization. Several factors which require tweaking are the specific parameters to obtain optimal widths and lengths of the nanowires, specific temperature and duration of thermal oxidation, specific voltage and concentration of the electrochemical baths, and especially our top contact deposition. We currently sputter coat an indium tin oxide transparent conductor, however this is an expensive material and a very non-conformal deposition. Sol-gel deposition techniques and alternate transparent conduction oxides such as doped ZnO should be investigated.

The oxides currently used were chosen specifically for their ease of use with ECD as well as their abundance in the earth's crust. This allowed us to make quick initial progress inexpensively, as well as to follow our goal of creating a low-cost solar alternative. However the copper and zinc oxides are not particularly well suited to the solar spectrum as they have relatively wide band-gaps and it would behoove us to look into other material choices. The fact that copper forms a Schottky barrier with copper oxide precludes the creation of an optimal ohmic contact reducing the efficiencies we may obtain, and as such a different bottom contact material or absorber material should be investigated. Another option is to optimize this process for a Schottky barrier PV cell, where the junction is formed not from a difference in doping but from the depletion layer induced by the metal at the metal-semiconductor junction.

One potential problem to be wary of is that the nanowires are extremely pressure sensitive. Locations on the cell where they have been handled are visibly damaged under a microscope, and in some cases visible to the eye. Although unavoidable in the early stages of research, this is an important problem which must be addressed down the line. Work must be done to provide adequate handling techniques during the fabrication process, as well as sufficient encapsulation to ensure long-term operation when deployed.

5. Conclusion

In this chapter, we have presented a novel fabrication process for the creation of oxide based core-shell nanowire photovoltaic cells. The major focus of this design process has been to keep costs low. To do this, earth-abundant materials have been investigated as well as wet chemical fabrication methods. As it is early in the design, our samples are plagued by issues which should be rectified by optimization of the fabrication process. Although we have seen a diode response from the fabricated samples, we are unsure of whether this is due to the possible schottky diode formed between the copper and copper oxide layers, or from the pn junction. These devices have the potential to become incredibly cheap solar cells but to achieve this goal further research and development is necessary and warranted.

6. Acknowledgements

The authors would like to sincerely thank the Tufts Micro and Nanofabrication facility as well as Harvard CNS for use of their clean room facilities. We would like to thank the

Wittich Energy Sustainability Research Initiation Fund for their funding as well as the National Science Foundation as this material is based upon work supported under a National Science Foundation Graduate Research Fellowship.

7. References

- Andricacos, P. C. (1999). "Copper On-Chip Interconnections." *The Electrochemical Society Interface* 8(1): 6.
- Cabrera, N. and N. Mott (1949). "Theory of the oxidation of metals." *Reports on Progress in Physics* 12: 163.
- Cao, G. and D. Liu (2008). "Template-based synthesis of nanorod, nanowire, and nanotube arrays." *Advances in Colloid and Interface Science* 136(1-2): 45-64.
- Cao, L. Y., P. Y. Fan, et al. (2010). "Semiconductor Nanowire Optical Antenna Solar Absorbers." *Nano Letters* 10(2): 439-445.
- Da Rosa, A. V. (2005). *Fundamentals of Renewable Energy Processes*, Elsevier Academic Press.
- Durney, L. J. (1984). *Electroplating engineering handbook*. New York, Van Nostrand Reinhold.
- Givargizov, E. I. (1975). "Fundamental aspects of VLS growth." *Journal of Crystal Growth* 31: 20-30.
- Golden, T. D., M. G. Shumsky, et al. (1996). "Electrochemical deposition of copper(I) oxide films." *Chemistry of Materials* 8(10): 2499-2504.
- Gordon, R., D. Hausmann, et al. (2003). "A kinetic model for step coverage by atomic layer deposition in narrow holes or trenches." *Chemical Vapor Deposition* 9(2): 73-78.
- Green, M. A., K. Emery, et al. (2010). "Solar cell efficiency tables (version 35)." *Progress in Photovoltaics: Research and Applications* 18(2): 144-150.
- Hu, L. and G. Chen (2007). "Analysis of Optical Absorption in Silicon Nanowire Arrays for Photovoltaic Applications." *Nano Letters* 7(11): 3249-3252.
- Jiang, X., T. Herricks, et al. (2002). "CuO Nanowires Can Be Synthesized by Heating Copper Substrates in Air." *Nano Letters* 2(12): 1333-1338.
- Kasap, S. O. (2001). *Optoelectronics and Photonics Principles and Practices*. Upper Saddle River, New Jersey, Prentice-Hall Inc.
- Kasap, S. O. (2006). *Principles of Electronic Materials and Devices*. New York, McGraw-Hill.
- Kempa, K., M. J. Naughton, et al. (2009). "Hot electron effect in nanoscopically thin photovoltaic junctions." *Applied Physics Letters* 95(23): 233121.
- King, D. L., M. A. Quintana, et al. (2000). "Photovoltaic module performance and durability following long-term field exposure." *Progress in Photovoltaics: Research and Applications* 8(2): 241-256.
- Langdon, P. H., Ed. (1988). *Metal finishing. Guidebook & directory issue*. Hackensack, N.J., Metals and Plastics Publications.
- Look, D. C., J. W. Hemsky, et al. (1999). "Residual Native Shallow Donor in ZnO." *Physical Review Letters* 82(12): 2552.
- Loster, M. (2010). "Total Primary Energy Supply - From Sunlight." Retrieved January 18, 2011, from http://www.ez2c.de/ml/solar_land_area/.
- Luque, A. and S. Hegedus (2003). *Handbook of Photovoltaic Science and Engineering*, John Wiley & Sons.

- Madou, M. J. (2002). *Fundamentals of microfabrication: the science of miniaturization*. Boca Raton, CRC Press.
- Menke, E. J., M. A. Thompson, et al. (2006). "Lithographically patterned nanowire electrodeposition." *Nat Mater* 5(11): 914-919.
- Muskens, O. L., J. G. m. Rivas, et al. (2008). "Design of Light Scattering in Nanowire Materials for Photovoltaic Applications." *Nano Letters* 8(9): 2638-2642.
- Njeh, A., T. Wieder, et al. (2002) "Reflectometry studies of the oxidation kinetics of thin copper films." *Surface and Interface Analysis*, 626-628 DOI: 10.1002/sia.1421.
- Ozgur, U., Y. I. Alivov, et al. (2005). "A comprehensive review of ZnO materials and devices." *Journal of Applied Physics* 98(4): 041301-103.
- Paunovic, M., M. Schlesinger, et al. (1998). *Fundamentals of electrochemical deposition*. New York, Wiley.
- Rakhshani, A. E. (1986). "Preparation, characteristics and photovoltaic properties of cuprous oxide--a review." *Solid-State Electronics* 29(1): 7-17.
- Ritala, M. and M. Leskela (2001). "Atomic layer deposition." *Handbook of thin film materials* 1: 103-159.
- Rusu, G. G., M. Girtan, et al. "Preparation and characterization of ZnO thin films prepared by thermal oxidation of evaporated Zn thin films." *Superlattices and Microstructures* 42(1-6): 116-122.
- Saleh, B. E. A. and M. C. Teich (2007). *Fundamentals of Photonics*. Hoboken, New Jersey, John Wiley & Sons.
- Shui, J. and J. C. M. Li (2009). "Platinum Nanowires Produced by Electrospinning." *Nano Letters* 9(4): 1307-1314.
- Sun, Y., B. Mayers, et al. (2003). "Polyol Synthesis of Uniform Silver Nanowires: A Plausible Growth Mechanism and the Supporting Evidence." *Nano Letters* 3(7): 955-960.
- Tam, T. M. and R. D. Robinson (1986). "ANALYSIS OF FACTORS CONTROLLING PEEL STRENGTH OF BLACK OXIDE CONVERSION COATINGS." *Plating and Surface Finishing* 73(4): 74-77.
- Tian, B., X. Zheng, et al. (2007). "Coaxial silicon nanowires as solar cells and nanoelectronic power sources." *Nature* 449(7164): 885-889.
- U.S. Energy Information Administration (2010). *International Energy Outlook 2010*. Washington DC, US Government Printing Office.
- Wadia, C., A. P. Alivisatos, et al. (2009). "Materials Availability Expands the Opportunity for Large-Scale Photovoltaics Deployment." *Environmental Science & Technology* 43(6): 2072-2077.
- Wang, F., A. Dong, et al. (2006). "Solution-Liquid-Solid Growth of Semiconductor Nanowires." *Inorganic Chemistry* 45(19): 7511-7521.
- Yamaguchi, Y., M. Yamazaki, et al. (1998). "Photocatalytic ZnO films prepared by anodizing." *Journal of Electroanalytical Chemistry* 442(1-2): 1-3.
- Zach, M. P., K. H. Ng, et al. (2000). "Molybdenum Nanowires by Electrodeposition." *Science* 290(5499): 2120-2123.



Nanowires - Implementations and Applications

Edited by Dr. Abbass Hashim

ISBN 978-953-307-318-7

Hard cover, 538 pages

Publisher InTech

Published online 18, July, 2011

Published in print edition July, 2011

This potentially unique work offers various approaches on the implementation of nanowires. As it is widely known, nanotechnology presents the control of matter at the nanoscale and nanodimensions within few nanometers, whereas this exclusive phenomenon enables us to determine novel applications. This book presents an overview of recent and current nanowire application and implementation research worldwide. We examine methods of nanowire synthesis, types of materials used, and applications associated with nanowire research. Wide surveys of global activities in nanowire research are presented, as well.

How to reference

In order to correctly reference this scholarly work, feel free to copy and paste the following:

Dante DeMeo, Samuel MacNaughton, Sameer Sonkusale and Thomas Vandervelde (2011). Electrodeposited Copper Oxide and Zinc Oxide Core-Shell Nanowire Photovoltaic Cells, *Nanowires - Implementations and Applications*, Dr. Abbass Hashim (Ed.), ISBN: 978-953-307-318-7, InTech, Available from: <http://www.intechopen.com/books/nanowires-implementations-and-applications/electrodeposited-copper-oxide-and-zinc-oxide-core-shell-nanowire-photovoltaic-cells>

INTECH

open science | open minds

InTech Europe

University Campus STeP Ri
Slavka Krautzeka 83/A
51000 Rijeka, Croatia
Phone: +385 (51) 770 447
Fax: +385 (51) 686 166
www.intechopen.com

InTech China

Unit 405, Office Block, Hotel Equatorial Shanghai
No.65, Yan An Road (West), Shanghai, 200040, China
中国上海市延安西路65号上海国际贵都大饭店办公楼405单元
Phone: +86-21-62489820
Fax: +86-21-62489821

© 2011 The Author(s). Licensee IntechOpen. This chapter is distributed under the terms of the [Creative Commons Attribution-NonCommercial-ShareAlike-3.0 License](#), which permits use, distribution and reproduction for non-commercial purposes, provided the original is properly cited and derivative works building on this content are distributed under the same license.

IntechOpen

IntechOpen