

We are IntechOpen, the world's leading publisher of Open Access books Built by scientists, for scientists

5,300

Open access books available

130,000

International authors and editors

155M

Downloads

Our authors are among the

154

Countries delivered to

TOP 1%

most cited scientists

12.2%

Contributors from top 500 universities



WEB OF SCIENCE™

Selection of our books indexed in the Book Citation Index
in Web of Science™ Core Collection (BKCI)

Interested in publishing with us?
Contact book.department@intechopen.com

Numbers displayed above are based on latest data collected.
For more information visit www.intechopen.com



Shielding Analysis of the Secondary Coolant Circuit of Accelerator Driven Systems

Toshinobu Sasa and Hiroyuki Oigawa
*Japan Atomic Energy Agency
Japan*

1. Introduction

Disposition of radioactive waste is one of the key issues to make nuclear energy as a sustainable power resource for future power generation. To solve this issue, a long-term program for research and development on partitioning and transmutation called "OMEGA" (Options Making Extra Gains from Actinides and fission products) was adopted in 1988 by the Japan Atomic Energy Commission (Japan Atomic Energy Commission, 2009). The aims of the OMEGA Program are to widen options for future waste management and to explore the possibility to utilize high-level radioactive wastes as useful resources. To proceed the OMEGA program, partitioning and transmutation (P-T) is a key technology to reduce environmental impacts and source terms contained in the high level radioactive waste which was discharged from commercial nuclear power reactors. By using partitioning technology, the long-lived radioactive nuclides such as minor actinides (MAs) and long-lived fission products (LLFPs) can be extracted from high level radioactive waste. From the mass balance study performed under the OMEGA program, the lifetime of final disposal site can be prolonged 3 to 10 times more than current designed lifetime (Oigawa, et al. 2005). Under the framework of the OMEGA program, Japan Atomic Energy Agency (JAEA) has proposed a double-strata fuel cycle concept (Takano, et al. 2000) which consists of two fuel cycles; one is a commercial fuel cycle including current LWR cycle and also future FBR fuel cycle and the other is a small fuel cycle dedicated to the transmutation of MA and LLFP. By the double-strata fuel cycle shown in Fig. 1, long-lived radioactive nuclides are confined into the second-stratum small fuel cycle that includes an innovative nuclear system which is optimized to the transmutation of MA and LLFP. JAEA carries out research and development of accelerator-driven transmutation systems (ADS) as an innovative dedicated transmutation system under the OMEGA Program.

In the P-T, the most effective reaction to transmute MA separated from high level radioactive waste by partitioning process into short-lived/stable nuclides is fission reaction. By fission reaction, target MA nuclides can be directly transmuted into short or stable nuclides. However, to make fission reaction as dominant reaction in the nuclear reactor, the reactor core should be formed a fast neutron spectrum field. It requires rather large fuel inventory and diminishes some safety characteristics such as Doppler coefficient and delayed neutron fraction. Another point of view, MA discharged from current light water power reactors is roughly composed of 55% of neptunium, 40% of americium and 5% of

curium. Each nuclide has several difficulties to handle within the current fuel cycle because of their own physical/chemical characteristics. Neptunium requires special separation processes at reprocessing because the chemical properties of neptunium are similar to those of uranium and plutonium. Americium and curium can be easily separated from the other actinides but have several problems related to their physical properties such as decay heat release and particle emission. These nuclides also give the chemical instability, namely the low vapor pressure of americium which harms the soundness of burnup fuel pellet properties. It means that it is not easy to stabilize americium and curium in MOX type fuel (Sasa, et. al, 2009). From these reasons, JAEA proposes the dedicated transmutation system instead of the transmutation by commercial nuclear power reactors to keep the safety requirements and cost effectiveness of the commercial reactors.

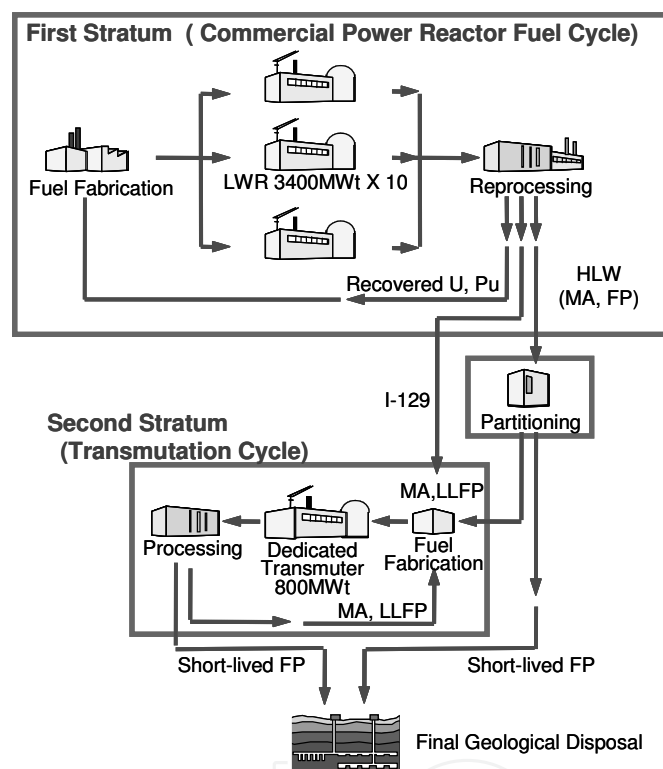

Fig. 1. Double-strata fuel cycle concept

ADS is one of the innovative nuclear systems that is a hybrid system composed of a high-intensity proton accelerator and a subcritical fast core. By using a subcritical core, the safety issues caused by the characteristics of MA can be compensated. However, to realize the ADS, there are some technical problems such as stable operation of accelerator, interface components between an accelerator and a reactor core, properties of MA fuels, adoption of liquid metal coolant, and so on (Sugawara, et al., 2009). This chapter mentions the issues related to the radiation protection from irradiated components installed in the tank-type subcritical core of a JAEA-proposed lead-bismuth cooled ADS.

2. Outline of ADS

Figure 2 shows a conceptual view of a JAEA-proposed ADS. MA is extracted from the spent fuel of commercial reactors and used as a dominant fuel component for ADS.

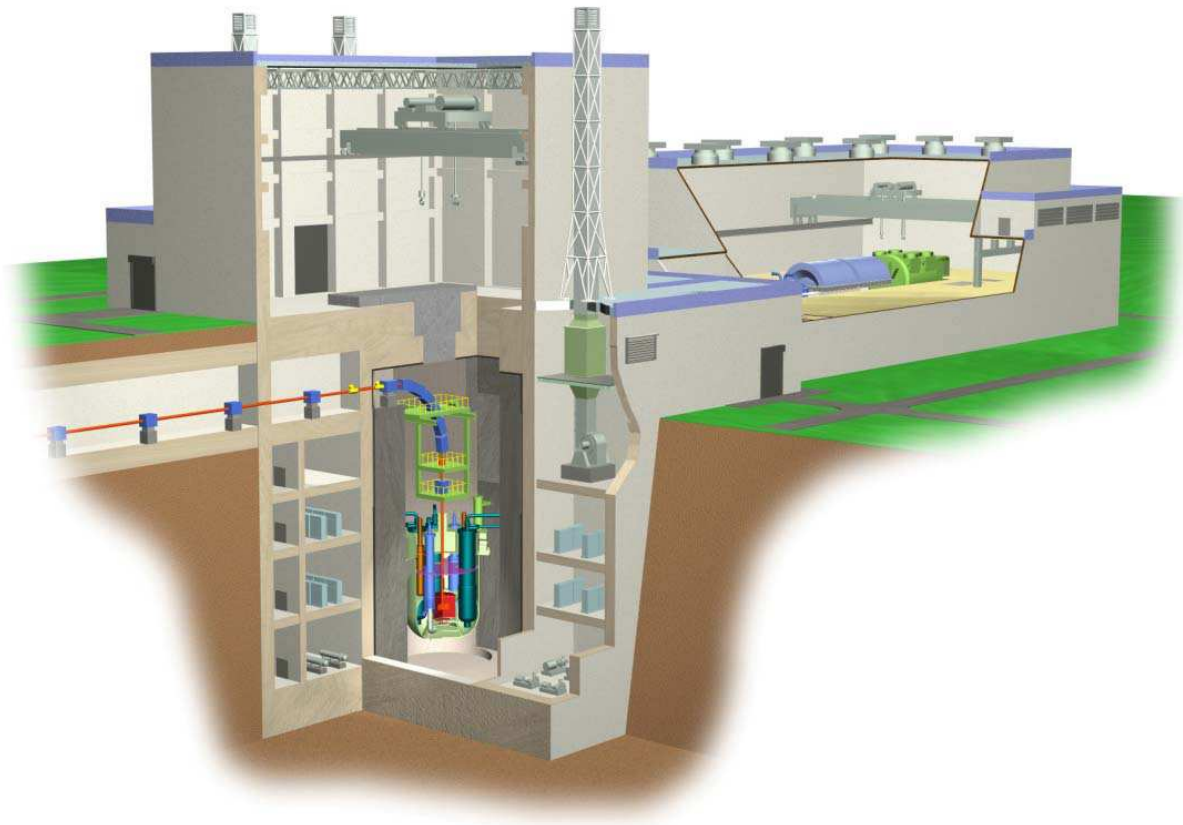

Fig. 2. Conceptual view of ADS plant

The system is mainly composed of a high intensity proton accelerator and a fast neutron spectrum subcritical core. Accelerated protons are injected into the subcritical core through the spallation target zone which is located at the center of the subcritical core. The subcritical core is driven by neutrons generated by spallation reaction of protons delivered from an accelerator with heavy metal target nuclides. To obtain enough efficiency of neutron production by spallation reaction, proton energy is set about 1 GeV to 1.5 GeV. In the case of JAEA-proposed ADS, proton energy is set at 1.5 GeV to reduce the proton beam current density. The vacuum zone inside the accelerator beam duct and the subcritical core was separated by the beam window. The beam window is fabricated by thin steel plate and formed like semi-sphere shape to sustain mechanical stress caused by the irradiation and heat deposition of protons and static pressure of lead-bismuth, simultaneously. Optimization of the beam window structure is one of the key issues of ADS design. To improve the soundness of beam window, effective and stable cooling is indispensable. From the preliminary design, a guide tube and an inlet nozzle are equipped to the beam duct. The inlet temperature of primary coolant is set at low value, 300°C to achieve effective cooling of the beam window.

The subcritical core is driven by the spallation neutrons. Because the core is set to subcritical condition, the fission chain reaction is not kept without the external neutron source. Released energy from fission reaction in the subcritical core is converted to electric power and used for the operation of the own accelerator. Residual electricity can be supplied to the power grid. The output electric power is about 250 MW, which means the ADS can be a self-sustaining system providing the efficiency of the accelerator is more than 15%. The block diagram of a power generation system and heat balance is illustrated in Fig. 3.

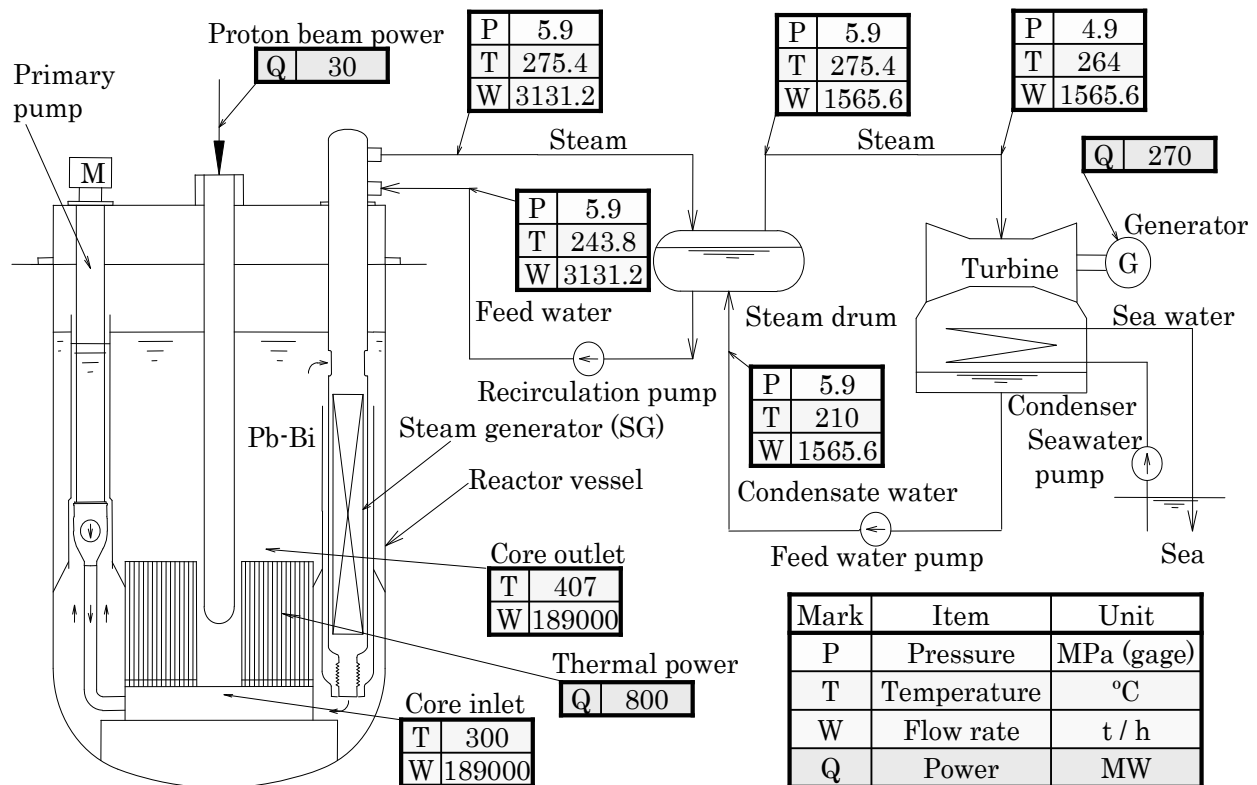

Fig. 3. Block diagram of power generation system and heat balance of ADS

The reference ADS design proposed by JAEA is 800 MW of thermal power and consists of a fast subcritical core fuelled with MA nitride and cooled by lead bismuth eutectic alloy (Pb-Bi), a spallation neutron source using Pb-Bi spallation target and a superconducting proton linear accelerator. According to the rated operation power of 800MW_{th}, about 250 kg of MA can be transmuted annually by fission reactions, which corresponds to the amount of MA produced from 10 units of large-scale commercial LWR spent fuels whose burn-up is 33,000 MWD/tHM.

In the reference design, the maximum value of an effective multiplication factor, k_{eff} , is set to 0.97 (Tsujimoto et al., 2004). To achieve the thermal power with this k_{eff} about 12 MW of a proton beam is required. Moreover, taking into account of the burn-up reactivity swing, k_{eff} will be deteriorated to 0.94, where proton beam of about 27 MW is necessary. A superconducting linear accelerator is suitable to supply such high power proton beam. Considering the energy efficiency of a neutron source, the specification of the proton beam, 1.5 GeV-18 mA, is chosen, though the acceleration energy should be finally determined by taking into account of the factors such as a cost of the accelerator and a proton beam current density distribution on the beam window surface.

As for the spallation target, Pb-Bi was chosen from several heavy metals, such as Hg and W, because of its good thermal property; the melting point of 125°C and the boiling point of 1670°C, respectively, although Pb-Bi is comparatively corrosive to steel at the high temperature. Many countries have started R&D to establish the technology for the usage of Pb-Bi and selection of the candidate structural materials for Pb-Bi cooling circuits.

Nitride fuel has the advantage of accommodating various MA with a wide range of composition besides good thermal properties. It can provide hard neutron spectrum suitable

for effective transmutation of MA. Moreover, when the ADS fuel is fabricated as a nitride, dry process is applicable for reprocessing of spent ADS fuels. For avoiding the production of radioactive ^{14}C , however, ^{15}N enriched nitrogen shall be used in the nitride fuel.

3. Specification of ADS components

The subcritical core of JAEA-proposed ADS is designed as a tank type layout because of the application of Pb-Bi coolant. Two units of primary pump and four units of steam generator are installed in the reactor tank. The proton beam power and reactor thermal output are specified to about 30MW and 800MW, respectively. The reactor outlet/inlet temperature of the primary coolant at rated operation is set to 407/300 °C. Steam generators can be directly inserted in the reactor vessel because Pb-Bi is chemically compatible with water. Turbine steam condition is set to the saturated steam turbine at 4.9 MPa.

3.1 Design of primary circulation pump

The primary circulation pump is operated at 300°C and flow amount is 94500 t/h (152 m³/min) according to the heat balance at rated operation. NPSH_{av} (Net Positive Suction Head) is 2.5 m and suction specific speed is set to 1150 rpm·m³/min·m. To specify the actual head, the pressures loss in primary circuit is set as follows,

Fuel bundle section	0.25MPa,
Core bottom structure	0.03MPa,
Steam generator	0.09MPa,
Coolant piping in reactor	0.03MPa, and
Total	0.4MPa.

From the specification, the actual head pressure loss of the primary circuit was specified to H=4.0m. The rotation frequency N is derived from the Suction specific speed S, NPSH_{av} and flow rate.

$$N = S \frac{H_{sv}^{3/4}}{\sqrt{Q}} = 185.5 \text{ rpm} \quad (1)$$

Impeller rim speed U_2 at lifting coefficient $\phi=0.3$ is delivered from following equation.

$$U_2 = \sqrt{\frac{gH}{\phi}} = 11.4 \text{ m/s} \quad (2)$$

And then, diameter of the impeller D_2 are specified as follows.

$$D_2 = \frac{60U_2}{\pi V} = 1.21 \text{ m} \quad (3)$$

3.2 Specification of steam generator

Heat transfer tube for steam generator is set to 12Cr steel which has good heat transfer rate and high strength. Outer diameter of heat transfer tube is set to 31.8 mm, which is as same as Japanese prototype fast breeder reactor "Monju". The thickness of the tube was set to 1.6

mm considering required strength determined by outer pressure, margin for corrosion by Pb-Bi or water and margin for manufacturing.

Heat transfer area is determined by considering the depth of the beam window and height of the heat transfer region (3.6 m). From the analysis with the conditions mentioned above, the number of the heat transfer tube is 255 which is assembled in 15 layer of helical pipes. The effective heat transfer area and effective heat transfer height of helical coil are 569 m² and 3510 mm, respectively. The specification of steam generator is summarized in Table 1.

Type, Number of units		Helical coil type with free fluid surface, 4 units
Total heat exchange quantity		205 MW
Rated flow volume	Pb-Bi side	47,250 t/h
	Steam side	782.8 t/h
Rated operation temperature	Pb-Bi (Inlet/Outlet)	407 °C/300 °C
	Steam (Inlet/Outlet)	243.8 °C / 275.4 °C
Steam outlet pressure/Enthalpy		6MPa / 1998.8kJ/kg
Maximum temperature (Pb-Bi / Steam)		430 °C/410 °C
Maximum pressure (Pb-Bi / Steam)		0.8 MPa / 7.5 MPa
Thermal conductivity for 12Cr steel		27.78 W/mK at 350 °C
Inner surface roughness of heat transfer tube		0.05mm
Effective heat transfer area		120% of required heat transfer area
Effective heat transfer area		569 m ²
Effective heat transfer height		3510 mm
Pressure loss (Pb-Bi/Steam)		0.09 MPa / 0.25 MPa
Helical coil pitch (radial/axial) and angle		0.5mm/0.5mm, 9.04°

Table 1. Main parameters of the steam generator

Heat transfer section is designed as a helical coil type. A water/steam flows inside of the heat transfer tube and Pb-Bi circulates outside of the heat transfer tube. The Pb-Bi at hot-leg temperature enters the steam generator through the window located at the upper section of steam generator. After the heat exchange with water, Pb-Bi flows out of the bottom of steam generator. Water is supplied from the water supply room at the upper section of steam generator and goes down through the inner piping of the steam generator. Then, water goes up through the inside of the heat transfer tube and heat of the Pb-Bi is exchanged. From the current R&D activities, the most suitable candidate material for Pb-Bi cooling system is not decided. Then, structural material is tentatively set to Modified 12Cr Steel.

From the result of heat transfer analysis, water inlet pressure should be set below 6.5 MPa, and maximum operation pressure of heat-transfer pipe is set to 7.5 MPa. From these pressure conditions, the pipe wall thickness is specified. The outer diameter and wall thickness of heat-transfer pipe is set to 31.8mm and 0.8 mm, respectively, to bear these water pressure specifications. To reserve the margin for corrosion by Pb-Bi (0.64 mm), pipe wall thickness is finally set to 1.6mm.

When the number of the heat-transfer tube and layer number of helical coil are set to 255 and 15, respectively, heat transfer area is 621 m² and height of the helical coil is 3830 mm. After further optimization according to the layout of reactor tank, final design parameters was adjusted as follows; the number of the heat-transfer tube is 220 and layer number of the helical coil is 14. Total length of steam generator is 12.39 m and heat transfer area is 606 m². Conceptual view of steam generator unit based on the analysis results is illustrated in Fig. 4.

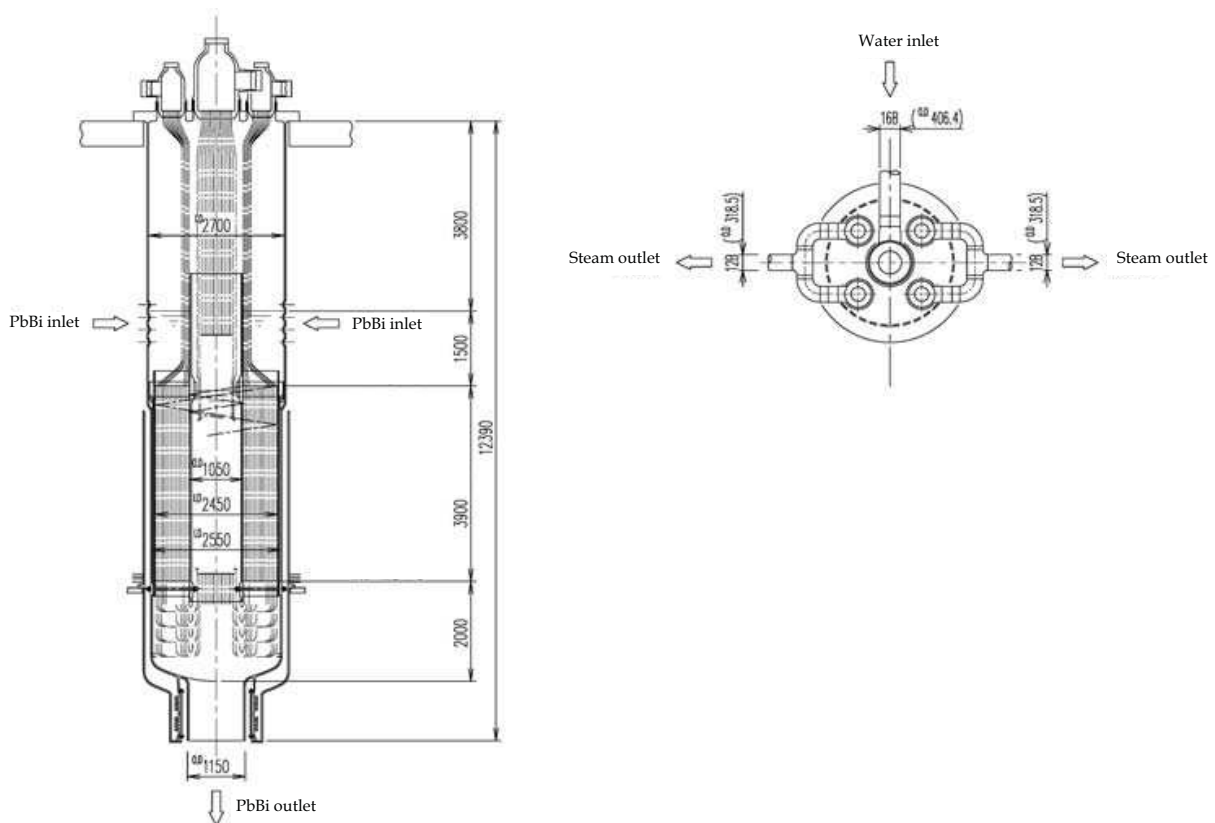

Fig. 4. Conceptual view of steam generator

ISI and maintenance of the heat transfer tube is performed by removing the top section of the steam generator. The steam generator itself can also be exchanged by extracting the device easily.

4. Shielding analyses around steam generator

For the maintenance of steam generator, irradiation of the structures located at the upper section of ADS subcritical core should be considered. Structure of the core and beam injection part is illustrated in Fig.5.

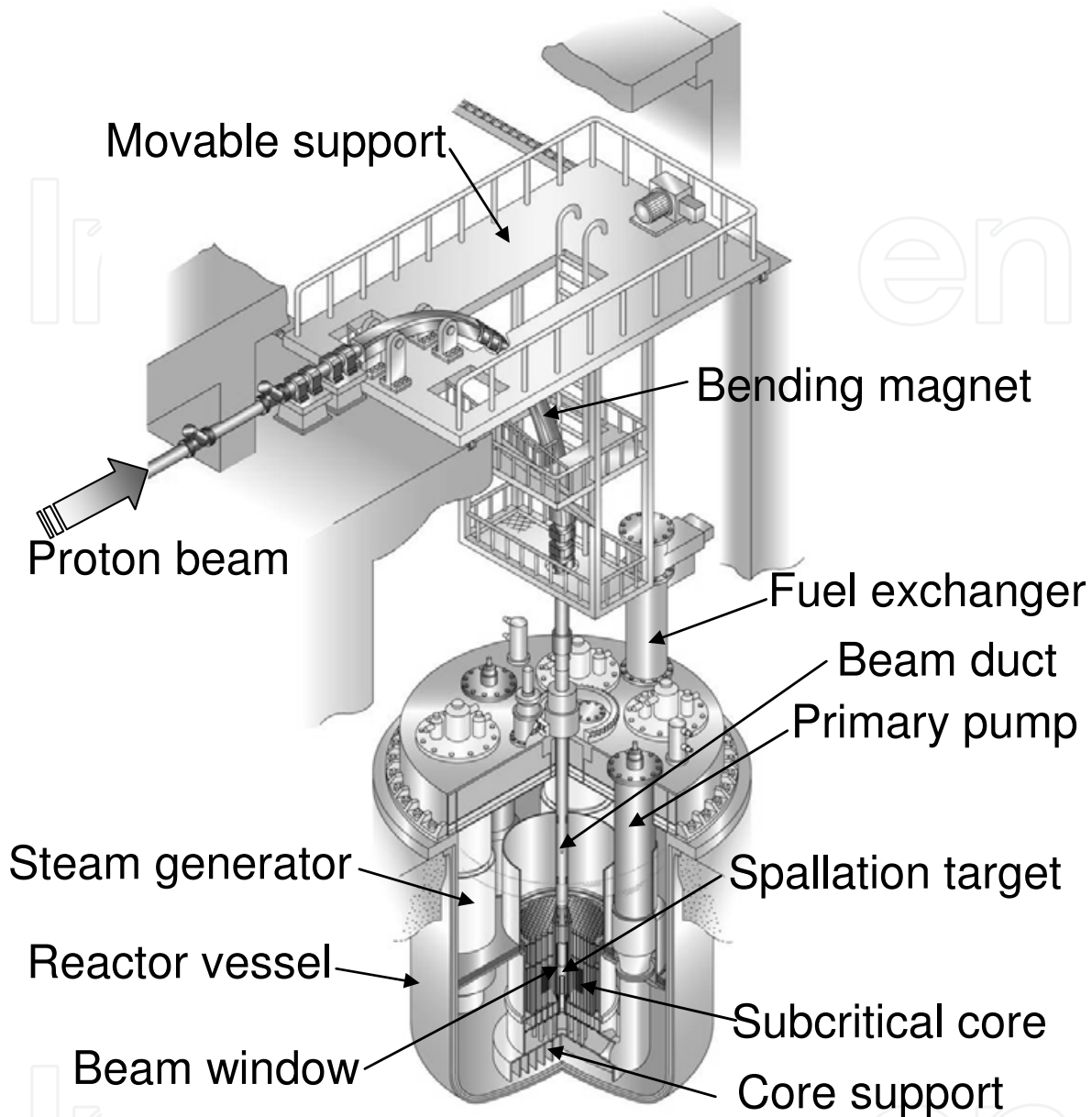

Fig. 5. Conceptual view of ADS subcritical core

Focusing magnets are the major component of beam transport line of ADS and are located at the upper part of the reactor vessel. Because the beam duct acts as a streaming path of the particles generated in the subcritical core, mainly neutron and photon, those magnets are heavily irradiated. To access the upper area of the subcritical core, the area locates a top section of steam generator, it is important to estimate the radiation dose from focusing magnets accurately.

Another point of view for radiation shielding, the system has four units of steam generator and then, secondary coolant, namely the water/steam, is also irradiated by secondary particles from subcritical core. It is also important to evaluate the radiation from irradiated secondary coolant through the piping to confirm the leakage radiation level satisfies the limitation of radiation non-controlled area.

4.1 Subcritical core configuration for modeling

Fuel loading pattern and structure of fuel assembly are shown in Figs. 6 and 7, respectively. Parameters for fuel assembly are summarized in Table 2.

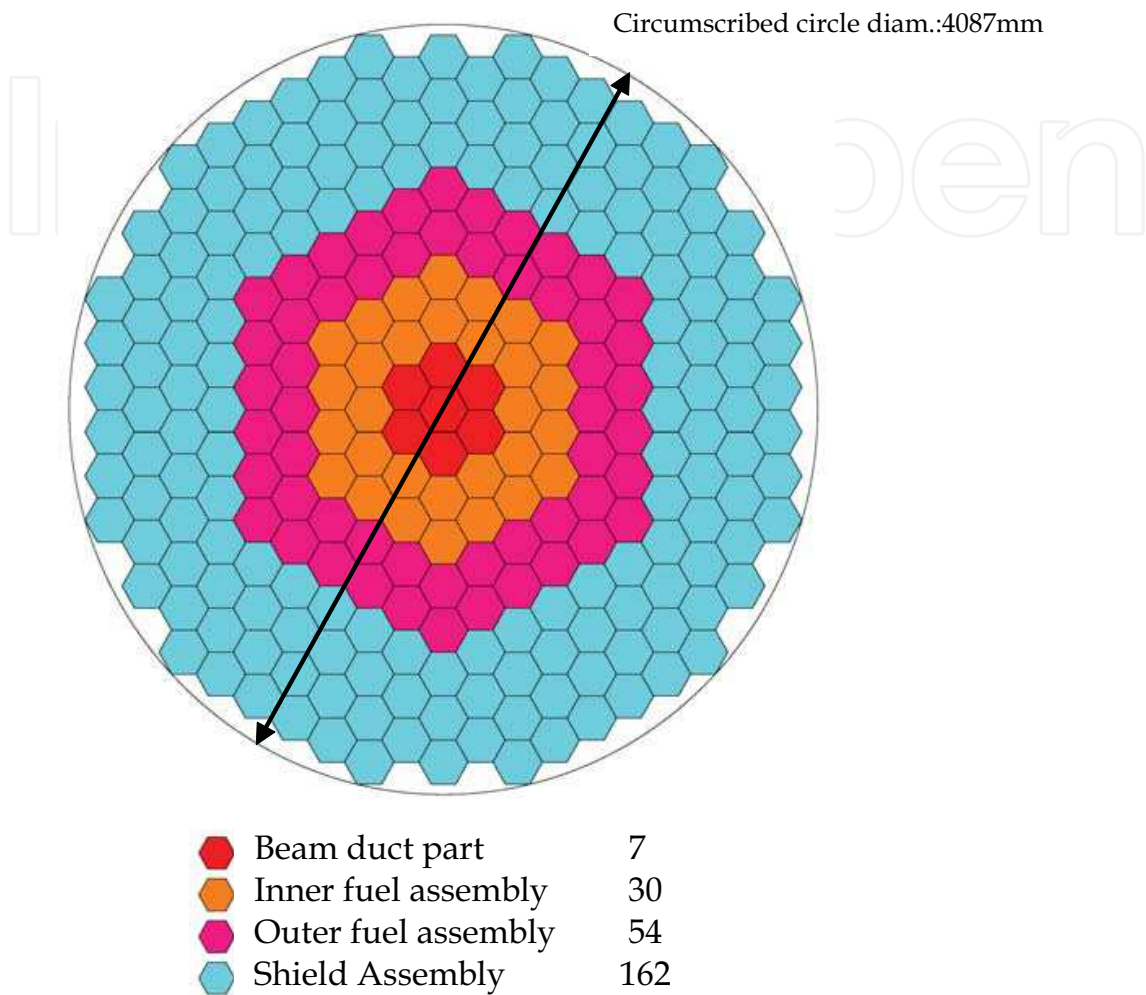

Fig. 6. Fuel loading pattern of ADS subcritical core

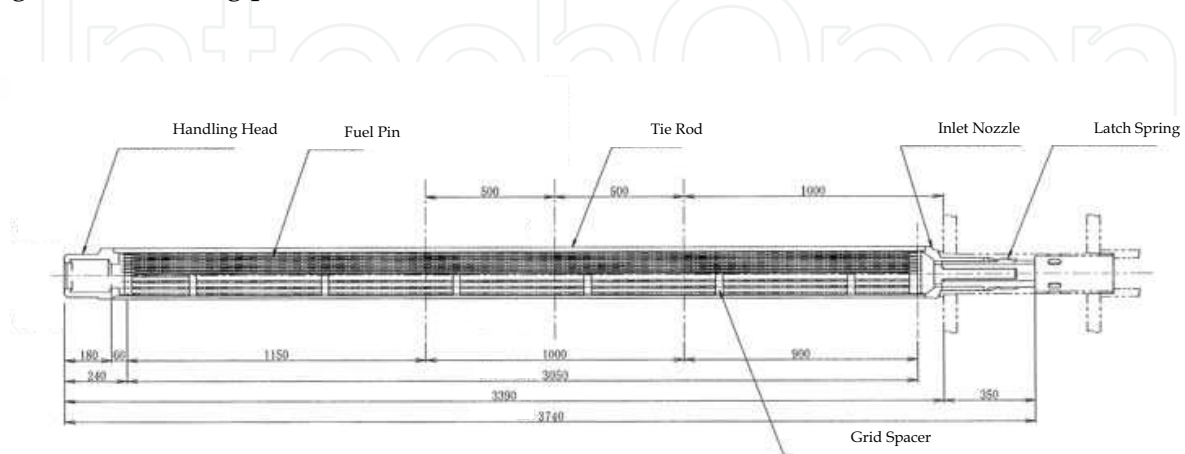

Fig. 7. Fuel Assembly for ADS

Number of fuel assemblies	84
Core equivalent radius	117.1 cm
Fuel composition	(MA, Pu) mono-nitride
Inert matrix	ZrN
Initial loaded Pu ratio	36 wt%
Inert matrix ratio	47.2 wt%
Fuel pellet density	95%TD (TD: Theoretical Density)
Pellet smear density	85%
Fuel pellet outer diameter	0.632 cm
Fuel-clad gap width	0.0165 cm
Clad outer diameter	0.765 cm
Clad thickness	0.05 cm
Actual fuel zone length	100 cm
Fuel pin pitch	1.148 cm
Fuel pin pitch/Clad OD (P/D)	1.5
Fuel assembly pitch	23.39 cm
Fuel pin number	391 pins/assembly
Tie rod number	6 rods/assembly

Table 2. Fuel assembly specification

As for the radial core layout, beam duct is located at the center of the core. Area of the beam duct is close to the area for 7 fuel assemblies. Around the beam duct, 84 fuel assemblies are located (30 inner fuel assemblies and 54 outer fuel assemblies). 162 units of reflector and shield assemblies (29 Pb-Bi assemblies, 33 SUS reflector assemblies and 100 B₄C shield assemblies) are located around the fuel zone. Pitch of the fuel assembly is 23.39 cm. A core vessel is made of Mod.9Cr-1Mo steel with 420 cm of inner diameter and 5 cm thick. A reactor vessel, which is also made of Mod.9Cr-1Mo steel, has 1120 cm of inner diameter and 5 cm thick. Radial distance of the center axis of steam generator is 390 cm from core center. The outer radius of the steam generator is 245 cm. Density of Pb-Bi coolant is 10.2 g/cm³ at the temperature of 430 °C.

As for the core layout along to the axial direction, length of the fuel assembly and fuel pin are 374 cm and 305 cm, respectively. Effective fuel length is 100 cm. Upper side of the fuel

meat, a 100 cm of gas plenum and a 15 cm shield are located. A 90 cm of SUS shield is attached at lower side of fuel meat. At the top of the reactor vessel, 200 cm thick shield plug made by concrete is located.

4.2 Design criteria for shielding

Design criteria of shielding is assumed as follows,

1. Radiation dose rate around secondary coolant piping should be lower than 6 $\mu\text{Sv/h}$ during rated operation,
2. Radiation dose by gamma ray to magnet cable is limited below 10 MGy, and
3. Radiation dose rate at the upper section of the core is less than 2 mSv/h.

To obtain radiation dose from particle flux, energy dependent dose conversion factor, which is illustrated in Fig.8 was used (Sakamoto & Yamaguchi, 2001).

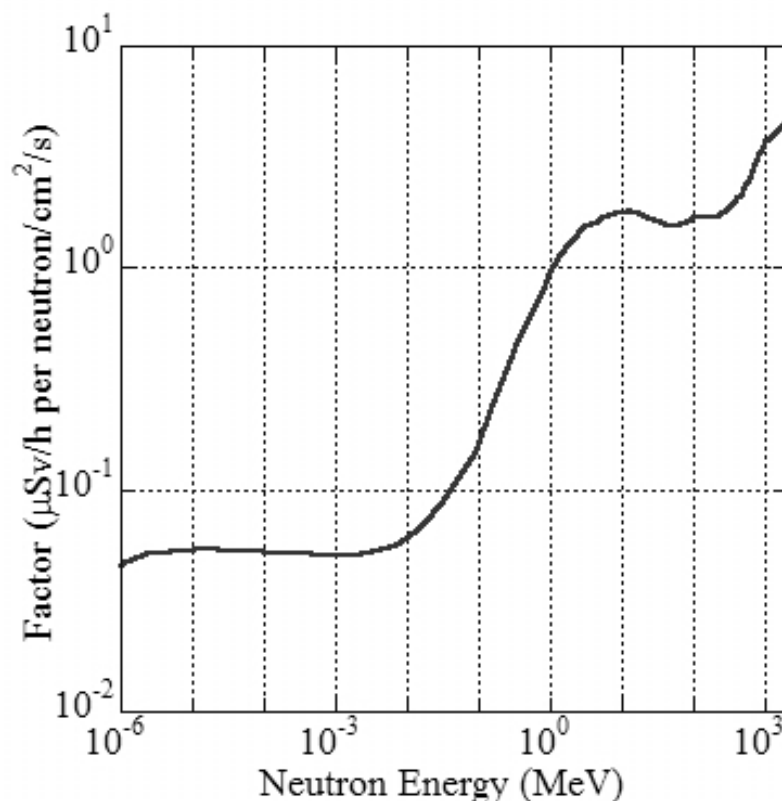

Fig. 8. Dose conversion factor for neutron

4.3 Streaming analysis through the beam duct

The 1.5 GeV proton beam is injected into the Pb-Bi spallation target that is located at the center of the core region, and generates spallation neutrons. These neutrons drive the subcritical core by fission chain reaction at the fuel region of the core. However, part of the neutrons escape from the core and are captured at the outside of the core zone and some of escaping particles runs through the beam duct, which is ordinarily kept in vacuum condition, without the attenuation. Based on these specifications discussed in section 3.1, calculation model for the streaming analysis was set as Fig.9 (Sasa, Yang & Oigawa, 2005).

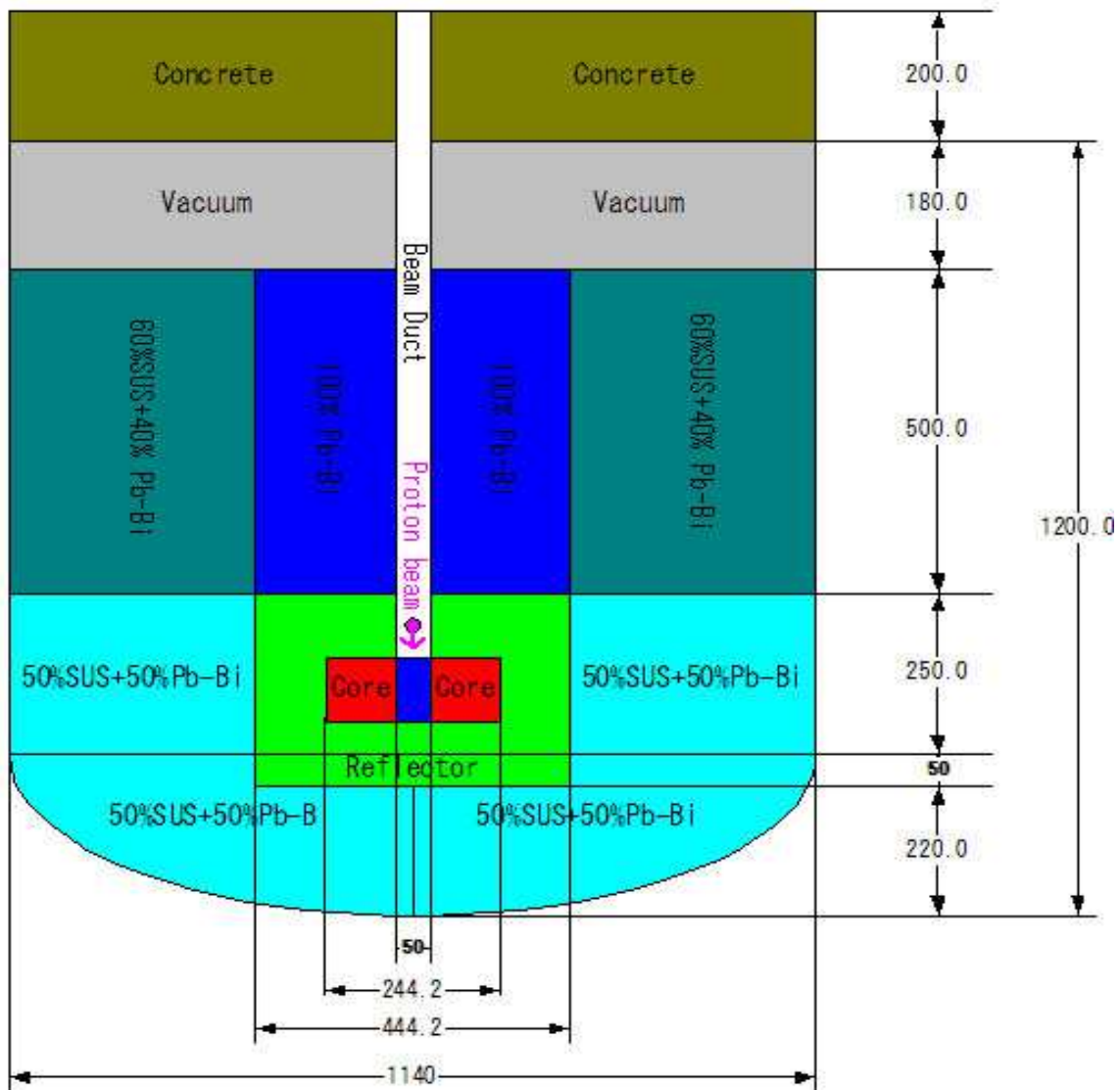

Fig. 9. Calculation model for streaming analysis

Before obtaining the activation of upper section devices, a leakage particle spectrum through the beam duct was calculated by MCNPX (CCC-705, 1999) with the Weight Window technique. For the analysis of secondary photons, the cross sections of almost all MA were substituted with those of plutonium because of lack of gamma-production cross section in JENDL-3.2 (Nakagawa et al., 1995). Figure 10 summarizes axial distributions of the radiation dose rates caused by neutrons and photons with (Duct case) and without (Bulk case) the beam duct during the rated operation.

From Fig.10, radiation doses at the bulk case give rather low value because of the large amount of the Pb-Bi at the upper plenum region. However, at the top of the subcritical core, the neutron radiation dose through the beam duct gives about 20 orders higher value than that of the bulk case. Some modifications are required to suppress the leakage particle such as application of narrower beam duct. To apply a narrow beam duct, optimization of the beam transport components especially for the beam expansion section must be performed simultaneously.

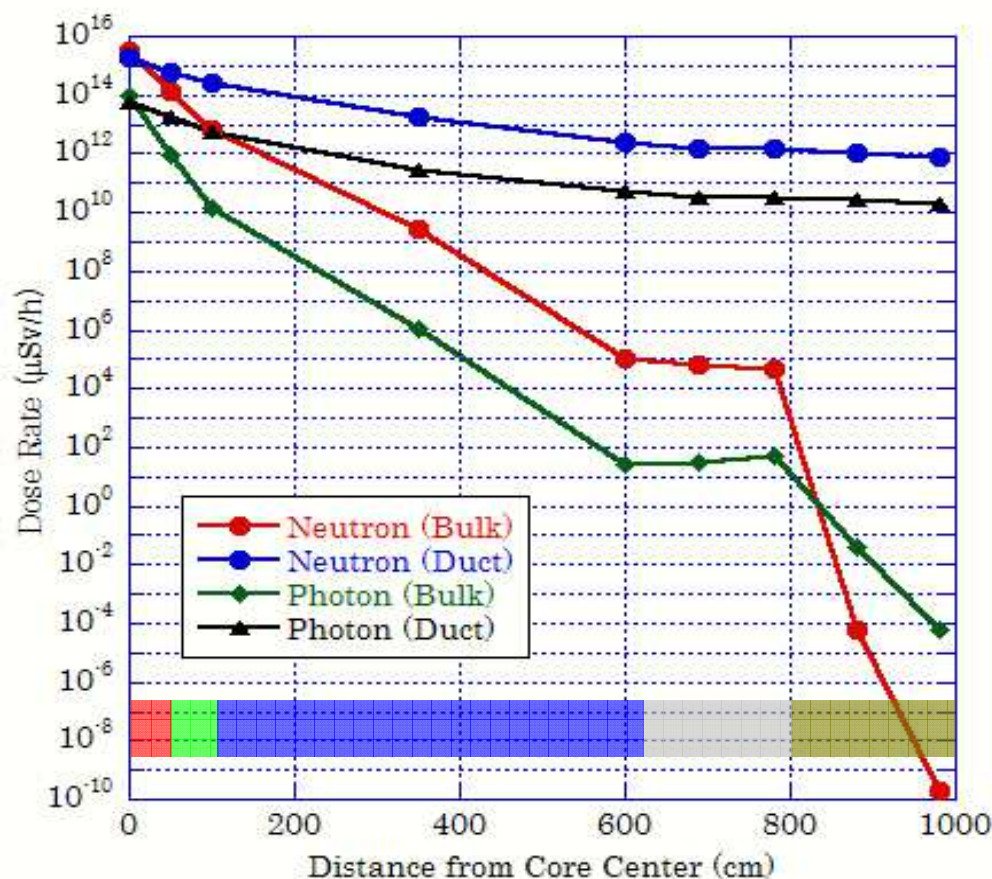

Fig. 10. Axial radiation dose distribution

Activation of the bending magnet, focusing magnets and shield plug was analyzed by PHITS (Iwase et al., 2002) and DCHAIN-SP (Kai et al., 2001) using the leakage neutron spectrum mentioned above. Two-dimensional calculation model and the calculation results are shown in Figs. 11 and 12, respectively. The proton beam power and operation period are 1.5 GeV/20 MW and 600 days, respectively. Figure 12 indicates that the radioactivity of the shield plug is 10^{15} Bq after 600 days of rated operation. It is almost the same value as those of beam window of the Pb-Bi target/cooled ADS (Nishihara and Sasa, 2001). Focusing magnets also have high radioactivity. Additional shield must be required to reduce the irradiation by streaming particles.

Using these activated sources, gamma-ray transport analysis was performed to determine the radiation dose of the workers during maintenance period. The radiation doses at three kinds of time period, ten days, thirty days and one year after system shutdown were analyzed. Figure 13 shows the trends of radiation dose level after system shutdown in unit of mSv/h. From the figure, maximum radiation dose are observed around additional steel shield plug (exceed 1 Sv/h) and nearby the magnets are in order of 1 to 100 mSv/h. These high radiation doses are caused from components closed to the reactor, namely an additional shield plug and a lower part focusing magnet. These conditions are kept through one month because of the contribution of Fe-55 (2.7 years of half-life) and Mn-54 (312 days half-life) generated from (n,p) reaction of Fe-54.

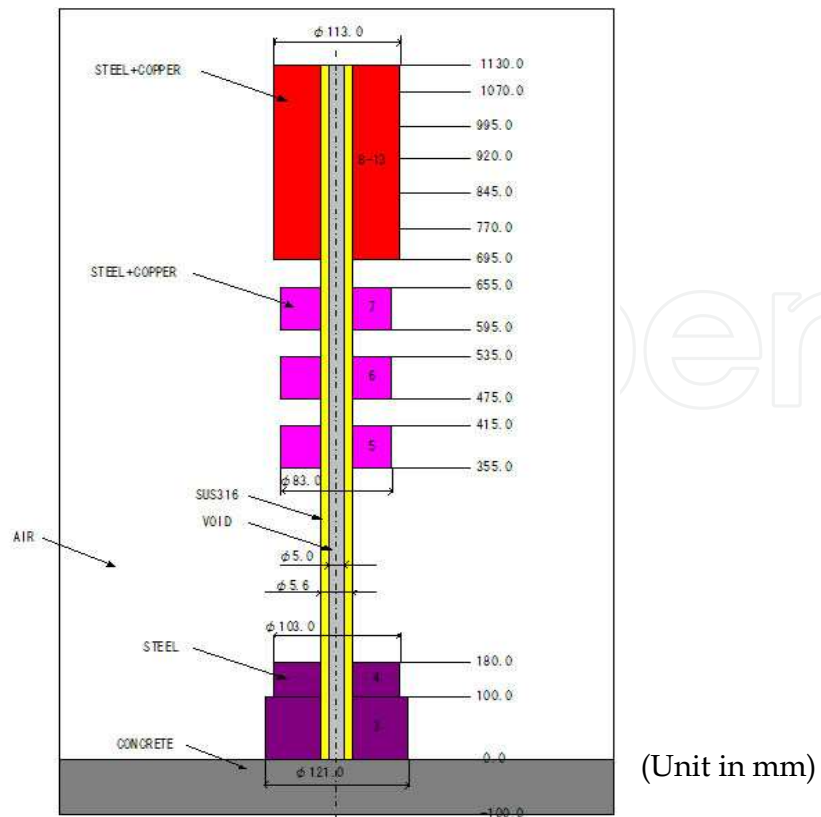

Fig. 11. Analysis model for activation analysis

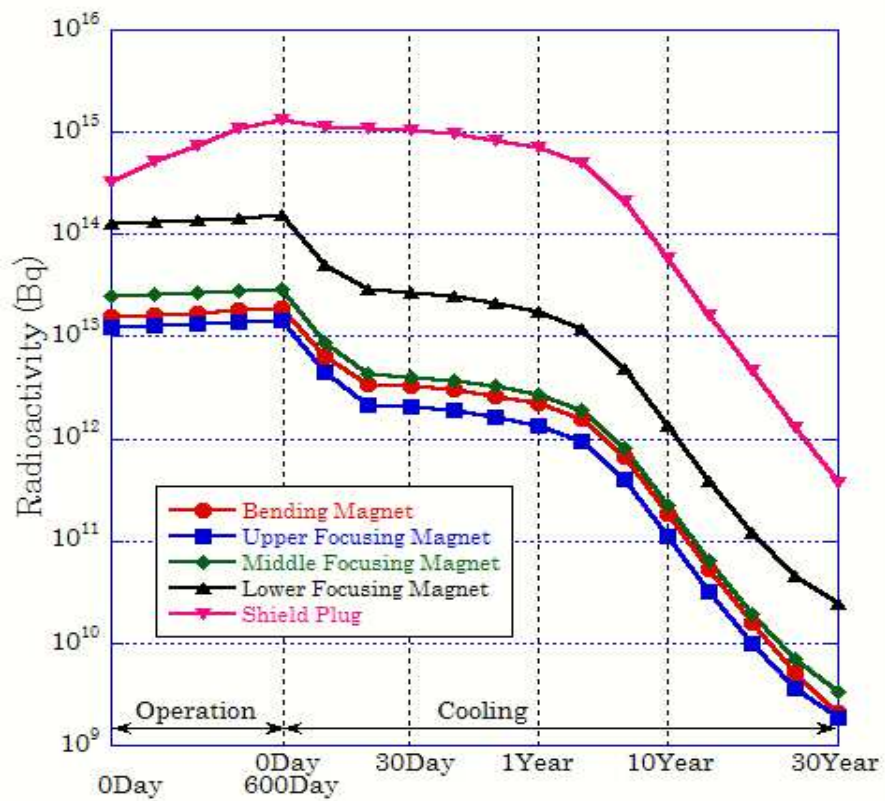

Fig. 12. Time evolution of radioactivity

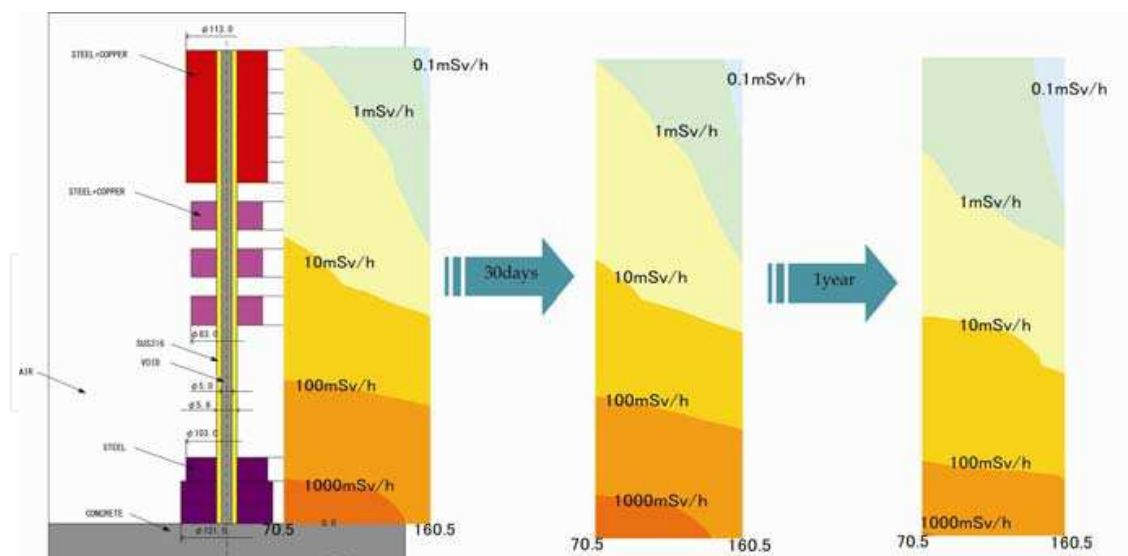

Fig. 13. Trends of radiation dose after shutdown

Compared with limitation of radiation exposure in Japan, the radiation dose near the magnets gives two or three order higher values. To suppress the radiation exposure of workers, the additional shield plug should be removed before maintenance period by remote operation. After the removal of additional shield plug, about ten to thirty minutes of maintenance time is applicable according to the maintenance positions.

4.4 Shielding analysis of the secondary coolant circuit

Because of the heavy weight of lead and bismuth, the JAEA-proposed ADS adopt a tank-type reactor vessel and then, cooling circuit components are located nearby the core barrel. The size of the steam generator is slightly larger than the similar-scale sodium-cooled fast reactor by the limitation of maximum operation temperature to suppress the corrosion of structural materials. Considering these conditions, the activation of secondary coolant might be larger than that of other fast reactors. The analysis using MCNPX code with LA150 and JENDL-3.2 based cross section libraries, was performed to specify the requirement of secondary coolant circuit shielding.

To define the leakage neutrons reaching the steam generator, inside the core barrel was modeled in detail. Material compositions of the inner structure of the core barrel were homogenized by referring to the fuel assembly structure and assembly layout. To conserve the computation time, steam generator was modeled in homogenized annular shape by taking into account the volumetric ratio of lead-bismuth, water and structural material. At first, reaction rates of ^{16}O (mainly a $^{16}\text{O}(n,p)^{16}\text{N}$ reaction) were calculated and then, following formula was used to calculate radioactivity of reaction products;

$$A_i = \sum_g N_i \cdot \sigma_g \cdot \phi_g \frac{1 - e^{-\lambda_i t_0}}{1 - e^{-\lambda_i t}} \quad (4)$$

where

A_i : Activity of nuclide in steam generator (Bq/gram),

g : Energy group number,

N_i : Number density of nuclide (10^{24} /gram H_2O),

- σ_g : Activation cross section of nuclide (barn),
 ϕ_g : Neutron flux in steam generator ($n/cm^2 \cdot s$),
 λ_i : Decay constant of decay products of nuclide (s^{-1}),
 t_0 : Round time of coolant in secondary loop (s), and
 t : Secondary coolant transit time in steam generator (s).

Figure 14 indicates the two-dimensional cylindrical calculation model for MCNPX.

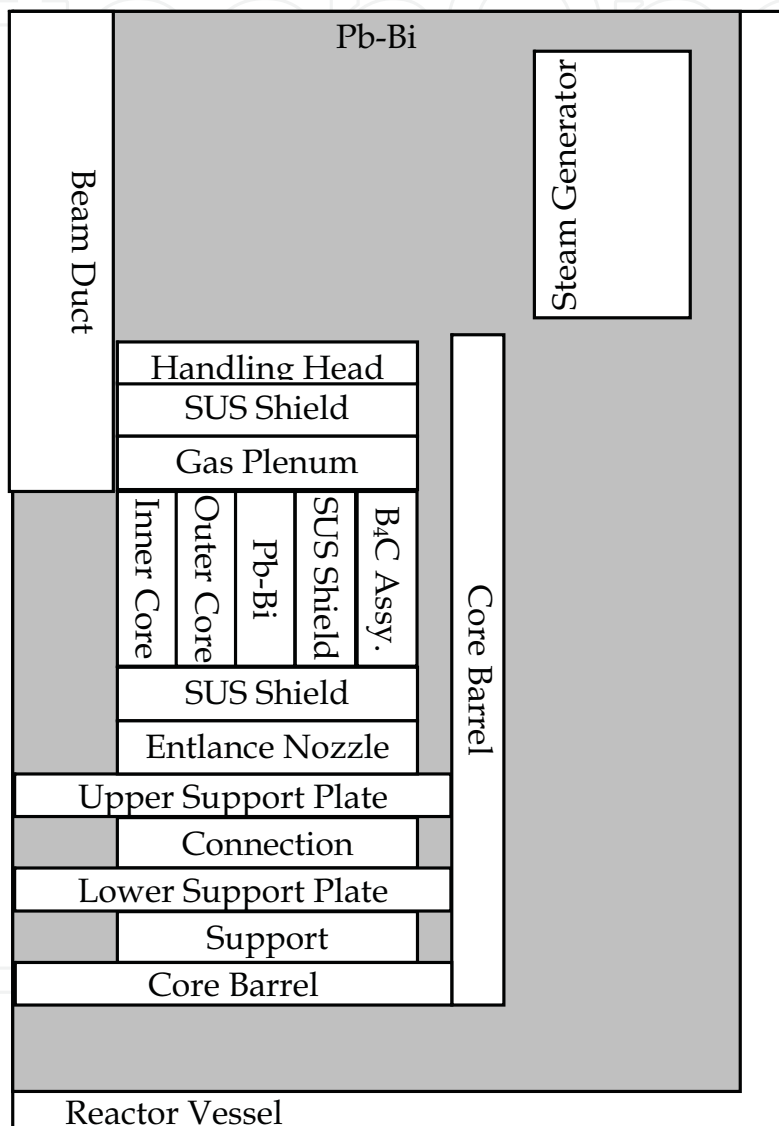

Fig. 14. Analysis model for secondary coolant activation by MCNPX

For the analysis of the radiation dose around the secondary loop, the dose rate calculation at the exit piping of the steam generator was performed using MCNPX code because of the short life time of ^{16}N (7.1 seconds half-life) by one dimensional cylindrical model. Figure 15 shows the neutron spectrum around the steam generator. Because the statistical error is not enough in high energy region, the neutron flux in 0.5 MeV is extrapolated above 2 MeV energy region to determine the reaction rates. By using the above mentioned formula, neutron reaction cross section of ^{16}O shown in Fig.16, and neutron flux information, ^{16}N

concentration is delivered to 0.12 Bq/gramH₂O. Figure 17 illustrates the gamma-ray radiation dose around the piping caused by ¹⁶N accumulation. It is shown that the radiation dose at the outside of the piping is 0.002 μSv/h and then, no specific shields are required for secondary cooling circuits.

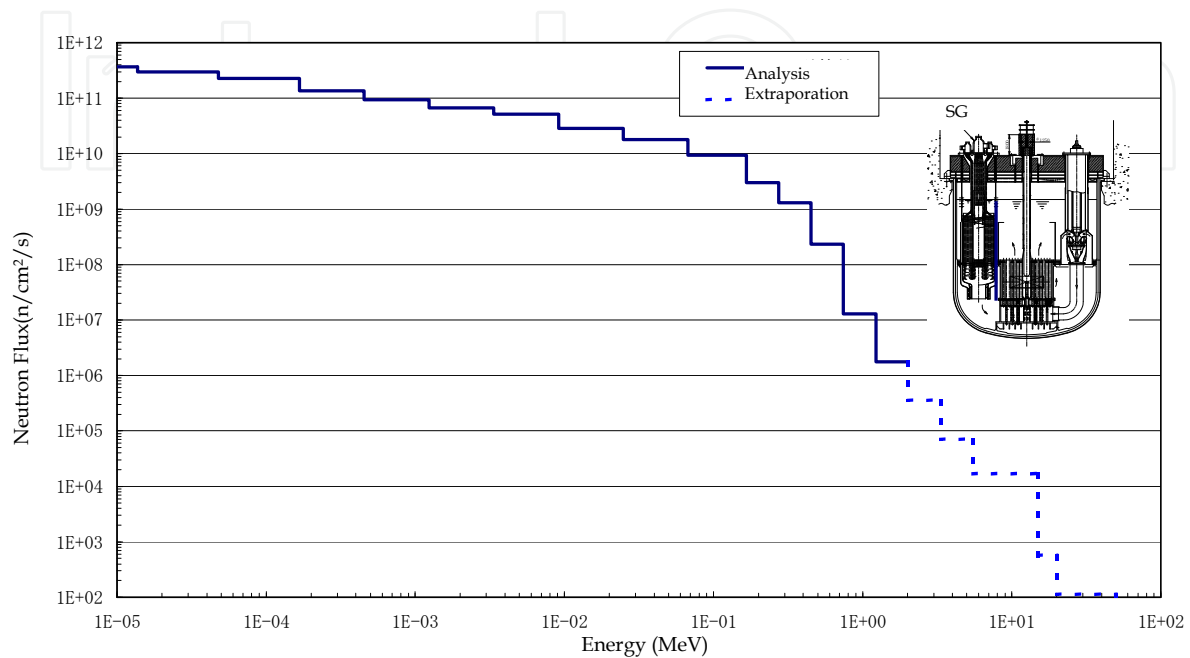

Fig. 15. Neutron energy spectrum at the outer surface of the steam generator

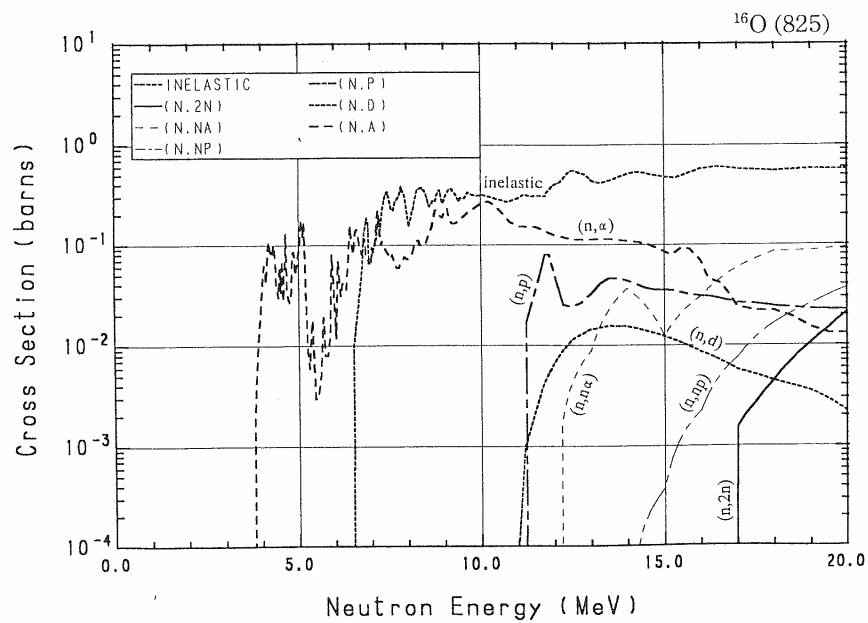

Fig. 16. Neutron reaction cross section for ¹⁶O

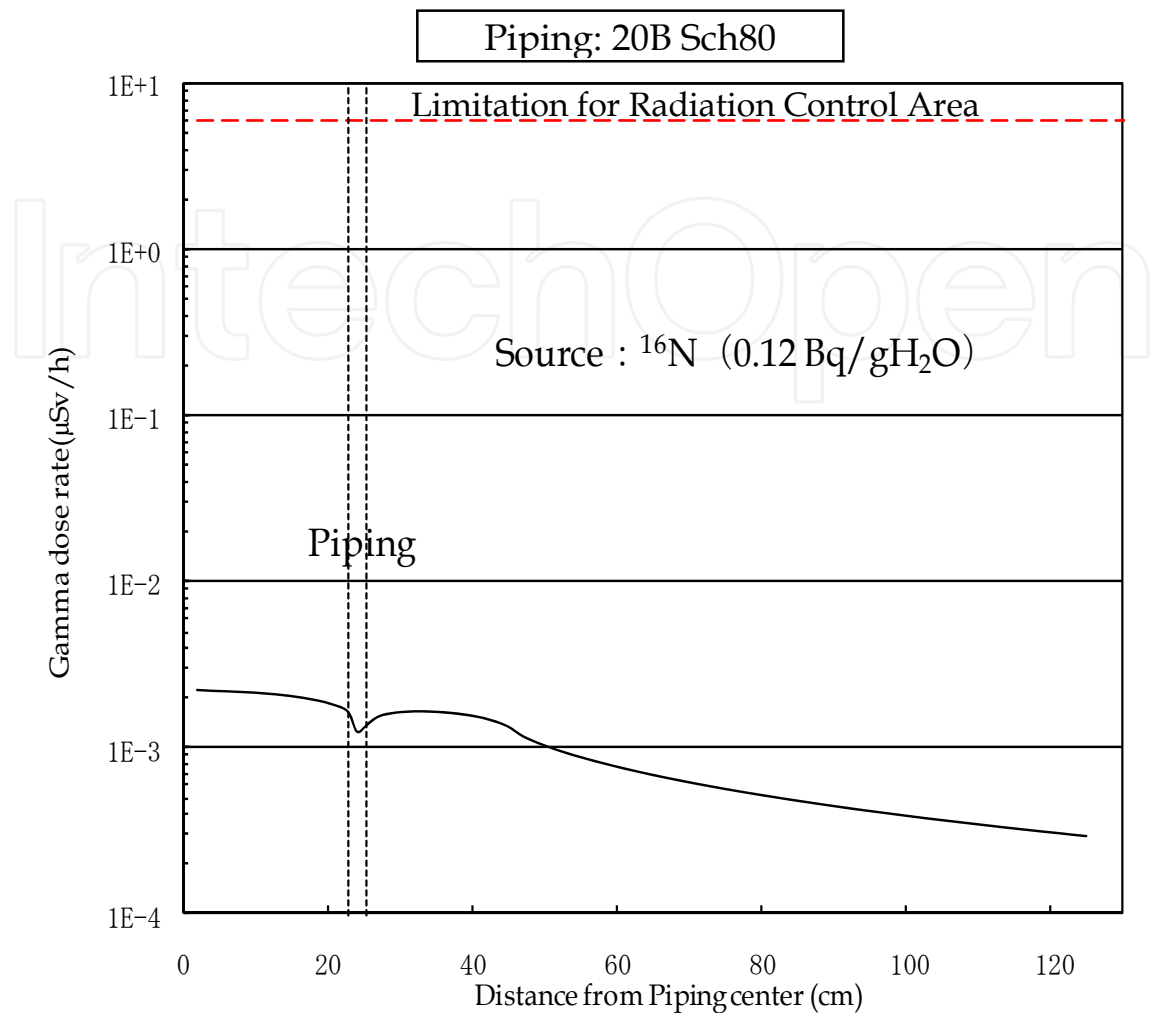

Fig. 17. Radiation dose rate distribution at secondary coolant piping

5. Conclusion

JAEA proceeds the research and development for partitioning and transmutation technology under the framework of the OMEGA program conducted by Japan Atomic Energy Commission since 1988.

To transmute long-lived radioactive nuclide, especially for the MA such as neptunium, americium and curium, fission chain reaction is suitable even though their physical and chemical characteristics is not necessarily compatible with other materials. To solve the problems to use minor actinides, JAEA promotes ADS which is an innovative nuclear system composed of high power proton accelerator and subcritical core.

To realize ADS, there are many technical issues to be solved. One of the issues is a shielding of high energy particles caused by spallation reaction of protons. In this chapter, we focused the influence of radiation exposure to the workers in two different viewpoints, activation of components set on the upper section of subcritical core including steam generator and radiation from secondary coolant which is irradiated in steam generator located in reactor vessel.

From Fig.10, the neutron radiation dose through the beam duct gives high activation dose than that of bulk case. To suppress the leakage particle, narrower beam duct might be effective. However, to apply a narrower beam duct at the shield plug position, optimization of the beam transport components especially for the beam expansion section must be performed simultaneously. In this study, it was found that the components set on the reactor vessel is heavily irradiated. It is indispensable to isolate shield plug before maintenance to access the upper section. Even the shield plug is isolated, allowable maintenance time for individual workers are limited within 30 minutes for hands on maintenance.

The analysis of the activation of secondary coolant was performed. Even using the detailed core configuration, which takes into account the closed layout of secondary cooling circuit to the fuel region, radiation dose caused by the activation of water/steam, namely an accumulation and circulation of ^{16}N , was not so high and satisfy the limitation of the regulation for radiation non-control area as shown in Fig. 17. In this case, Pb-Bi in reactor vessel acts as a shield. It results that no additional shield is needed for secondary cooling circuits.

6. References

- Japan Atomic Energy Commission (2009). Concerning the Report Entitled “*Current Status and a Way Forward to Promote the Research and Development of Partitioning and Transmutation Technologies*”, Japan
- CCC-705 (1999), *MCNPX version 2.1.5*, RSICC Computer Code Collection, Oak Ridge National Laboratory.
- Iwase H. et al. (2002), Development of General-Purpose Particle and Heavy Ion Transport Monte Carlo Code, *Journal of Nuclear Science and Technology*, Vol.39, pp.1142.
- Kai T. et al. (2001), DCHAIN-SP2001: High Energy Particle Induced Radioactivity Calculation Code, *JAERI-Data/Code* 2001-016.
- Nakagawa T. et al. (1995), JENDL-3 Version2, *Journal of Nuclear Science and Technology*, Vol. 32, pp.1259.
- Nishihara K. and Sasa T. (2001), Estimation of Activity and Toxicity for Spallation Product from the Target for Accelerator-Driven Transmutation System, *JAERI-Research* 2001-015 [in Japanese]
- Oigawa, H., et al. (2005). Parametric Survey on Possible Impact of Partitioning and Transmutation of High-level Radioactive Waste, *Proc. of GLOBAL2005, International Conference Nuclear Energy System for Future Generation and Global Sustainability*, Tsukuba, Japan, October 9-13, 2005.
- Sakamoto Y. and Yamaguchi Y. (2001), Dose Conversion Coefficients in the Shielding Design Calculation for High Energy Proton Accelerator Facilities, *JAERI-Tech* 2001-042.
- Sasa, T., Yang, J.A. and Oigawa, H. (2005), Shielding analysis at the upper section of the accelerator-driven system, *Radiation Protection Dosimetry*, Vol.116, No.1-4, pp.256.
- Sasa, T. et al. (2009), Liquid-fuelled accelerator-driven transmutation system, *Proceedings of 10th OECD/NEA Information Exchange Meeting on Actinide and Fission Product Partitioning and Transmutation* (CD-ROM)

- Sugawara, T. et al. (2009), Recent activities for accelerator driven system in JAEA, *Proceedings of International Conference on Advanced Nuclear Fuel Cycle; Sustainable Options & Industrial Perspectives (Global 2009) (CD-ROM)*
- Takano, H. et al. (2000), Transmutation of Long-Lived Radioactive Waste Based on Double-Strata Concept, *Progress in Nuclear Energy*, Vol.37, pp.371.
- Tsujimoto, K. et al. (2004), Neutronics Design for Lead-Bismuth Cooled Accelerator-Driven System for Transmutation of Minor Actinide, *Journal of Nuclear Science and Technology*, Vol.41, pp.21.

IntechOpen

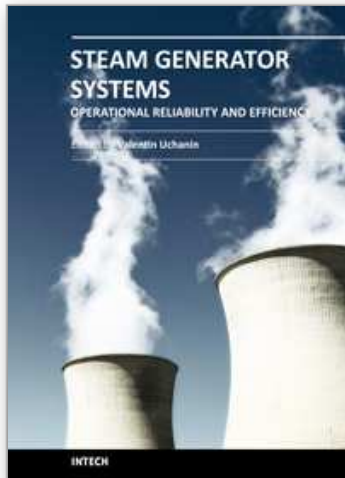

Steam Generator Systems: Operational Reliability and Efficiency

Edited by Dr. Valentin Uchanin

ISBN 978-953-307-303-3

Hard cover, 424 pages

Publisher InTech

Published online 16, March, 2011

Published in print edition March, 2011

The book is intended for practical engineers, researchers, students and other people dealing with the reviewed problems. We hope that the presented book will be beneficial to all readers and initiate further inquiry and development with aspiration for better future. The authors from different countries all over the world (Germany, France, Italy, Japan, Slovenia, Indonesia, Belgium, Romania, Lithuania, Russia, Spain, Sweden, Korea and Ukraine) prepared chapters for this book. Such a broad geography indicates a high significance of considered subjects.

How to reference

In order to correctly reference this scholarly work, feel free to copy and paste the following:

Toshinobu Sasa and Hiroyuki Oigawa (2011). Shielding Analysis of the Secondary Coolant Circuit of Accelerator Driven Systems, *Steam Generator Systems: Operational Reliability and Efficiency*, Dr. Valentin Uchanin (Ed.), ISBN: 978-953-307-303-3, InTech, Available from: <http://www.intechopen.com/books/steam-generator-systems-operational-reliability-and-efficiency/shielding-analysis-of-the-secondary-coolant-circuit-of-accelerator-driven-systems>

INTECH
open science | open minds

InTech Europe

University Campus STeP Ri
Slavka Krautzeka 83/A
51000 Rijeka, Croatia
Phone: +385 (51) 770 447
Fax: +385 (51) 686 166
www.intechopen.com

InTech China

Unit 405, Office Block, Hotel Equatorial Shanghai
No.65, Yan An Road (West), Shanghai, 200040, China
中国上海市延安西路65号上海国际贵都大饭店办公楼405单元
Phone: +86-21-62489820
Fax: +86-21-62489821

© 2011 The Author(s). Licensee IntechOpen. This chapter is distributed under the terms of the [Creative Commons Attribution-NonCommercial-ShareAlike-3.0 License](#), which permits use, distribution and reproduction for non-commercial purposes, provided the original is properly cited and derivative works building on this content are distributed under the same license.

IntechOpen

IntechOpen