

We are IntechOpen, the world's leading publisher of Open Access books Built by scientists, for scientists

5,300

Open access books available

130,000

International authors and editors

155M

Downloads

Our authors are among the

154

Countries delivered to

TOP 1%

most cited scientists

12.2%

Contributors from top 500 universities



WEB OF SCIENCE™

Selection of our books indexed in the Book Citation Index
in Web of Science™ Core Collection (BKCI)

Interested in publishing with us?
Contact book.department@intechopen.com

Numbers displayed above are based on latest data collected.
For more information visit www.intechopen.com



Effect of Long-Term Thermal Influence on Mechanical Properties of Welded Joints for Carbon Steels used in Power Engineering

Zilvinas Bazaras and Boris Timofeev

¹*Kaunas University of Technology,*

²*Saint Petersburg State Polytechnic University*

¹*Lithuania*

²*Russia*

1. Introduction

Carbon steels widely used in power engineering for manufacture of different types of equipment. A lot of part of WWER and RBMK equipments is produced from 22K steel (Timofeev, 1982) or its foreign analogs (Vaseneva, 1990). For example, the case of steam generator PGV-440, cases of separator and also the pipe-lines of the large diameter for NPP with RBMK reactors. Thus for manufacturing the equipment were used as the forgings and the plates or sheets from this steel of various methods of melt – open hearth furnace, vacuum arc and electro-slag re-melting. Separate semi-products of this equipment was joined using welding – MAW (manual arc welding), SAW (submerged arc welding) and ESW (electro-slag welding).

2. Information

Case of PGV-440 steam generator of NPP with WWER-440 reactors

Steam generator case (Zherebenkov, 1979) consists of two central shells (having a thickness of 135 mm) and two end shells (having a thickness of 78 mm) to which the nozzles Du-250, Du-500, Du-700, Du-1100 and some small nozzles and unions and also two bottoms (with thickness 84 mm) are welded. The case design is given in Fig.1. Plane billets of bottoms and shells of steam generators were produced using electro-slag welding of two plates of 22K steel with the use of Sv-10Mn2 wire and AN-8M flux. During edge preparation the edges of plates to be welded were subjected to ultrasonic inspection. Stamped bottoms after heat treatment were also tested using various inspection procedures. Shells were joined (using submerged arc welding with Sv-08A wire under AN-348A flux) with three circumferential welds. The welding up of nozzles which are displaced relatively the steam generator axis is carried out manually with the use of electrodes of the type YONI-13/55.

Thus steel type 22K (OHF, ESM or VAM) and three method of welding can be used at manufacture of PGV-440 steam generator.

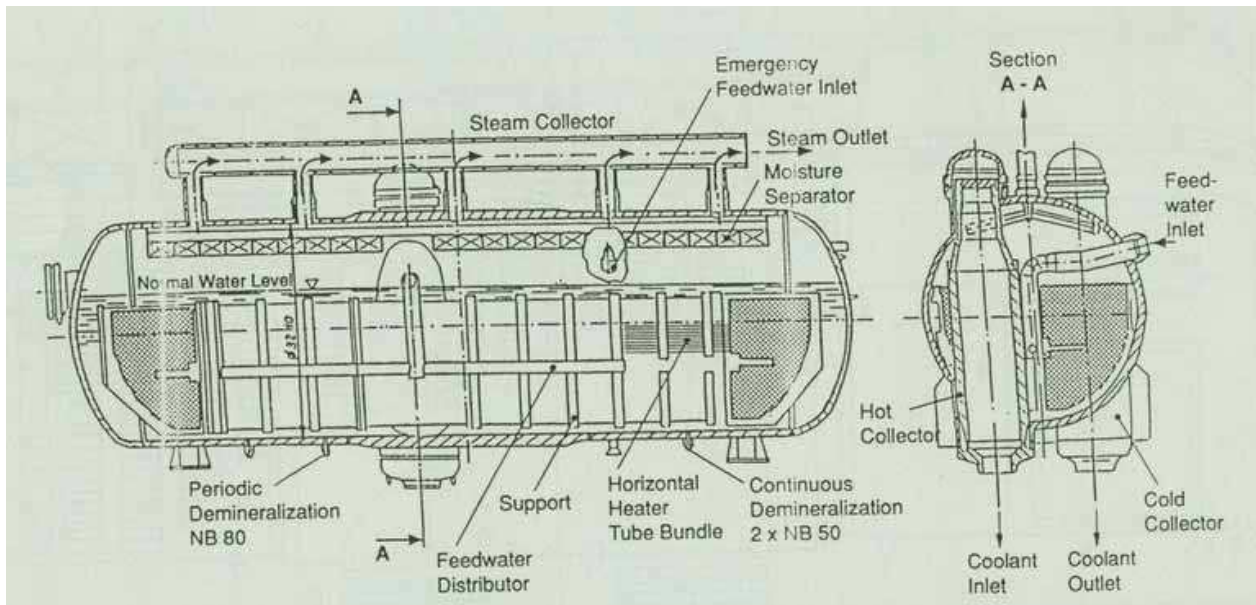

Fig. 1. Sketch of PGV-440 steam generator case

Separator drum of NPP with RBMK-1000 reactors

The design of separator drum of steam (Kashirin, 2004) is a vessel with the following geometrical dimensions: outer diameter - 2300 mm, length - 30480 mm, wall thickness - 105 mm. Sketch of design is presented in Fig.2.

Separators are manufactured from two semi-vessels, each of which consists of some sections. The section includes bottom (thickness - 115 mm) and shells (thickness - 105 mm) or only shells. Each of these elements are assembled from two clad plates, which (in the form of half-cylinders) are joined with longitudinal welds produced by electroslag welding (wire Sv-10Mn2, flux AN-8M). The different number of 22K steel heats (from 30 to 40) is used because one heat (2-4 ingots) may be used for different components of pressure vessel. Post-welding heat treatment is carried out on the following regime: normalization at $930 \pm 10^\circ\text{C}$ exposure for 2.5 hours, cooling in air. Welding of shells with each other and a shell with a bottom using circumferential welds is produced by submerged arc welding (SAW) using Sv-08A wire and AN-348A flux. After welding up circumferential welds the tempering is carried out at $630 \pm 10^\circ\text{C}$, exposure for 4 hours and cooling in air. Welding up of shells to nozzles is performed with manual arc welding (MAW) with the use of the type YONI-13/55 electrode and then the whole pressure vessel is subjected to tempering at $630 \pm 10^\circ\text{C}$ (heating rate - $80^\circ\text{C}/\text{min}$) for a time of 11 hours.

Separator drum case consists of 20 shells and 2 bottoms. Each shell is assembled from two components welded ("semi-troughs") together with two longitudinal welds. There is a man-hole in the separator case (Fig.3) numerous nozzles are welded in the case wall. Sketches of units of connecting nozzles to separator case are given in Fig.3.

It follows from Fig.3 that the largest holes (diameter 470 mm) in separator case wall are from 24 nozzles of down-comer pipe-lines, from a man-hole - diameter 400 mm, from nozzles of steam rejection - diameter 297 mm. Besides there are other nozzles with smaller holes including nozzles of steam-water service lines - diameter 76 mm. All these numerous nozzles are located in the separator case in the distance from longitudinal welds.

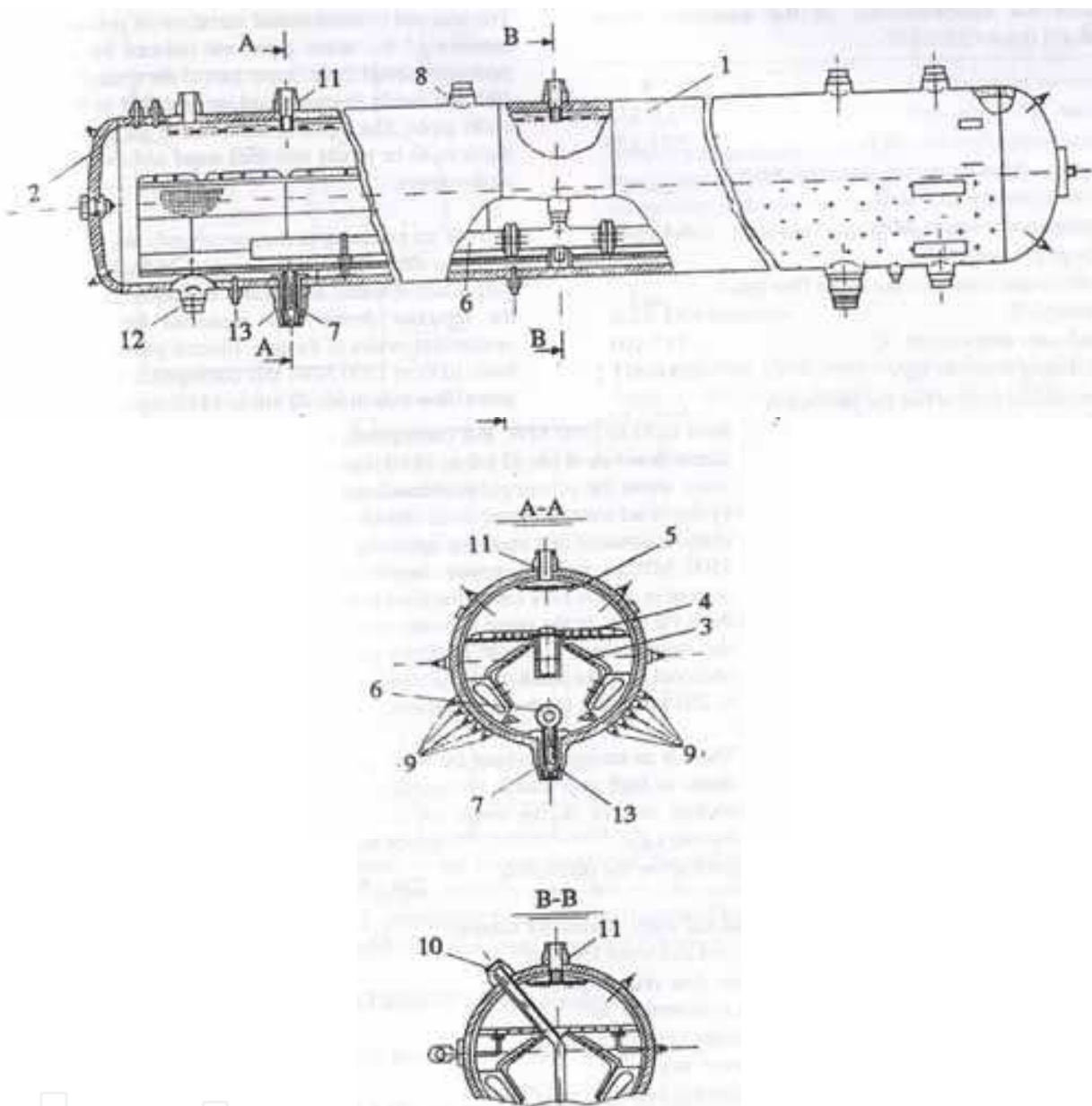

Fig. 2. Sketch of separator drum: 1 - vessel case; 2 - bottom; 3 - plate receiving water and steam flow; 4 - perforated plate in water; 5 - upper perforated plate; 6 - distribution collector of potable water; 7 - nozzle for water rejection; 8 - nozzle for steam line; 9 - nozzle of steam-water piping; 10 - nozzle of feed water; 11- nozzle in steam zone; 12 - nozzle in water zone; 13 - nozzle of down-comers

In connection with numerous holes in the steam separator case these zone are stress concentrators. Increased stresses are acting in them (above the yield stress) conditioned both by concentration and stiffness variation. The accumulation of fatigue damage is possible in stress concentration zones, which may cause both the nucleation of cracks and their development in the process of operation. As stated above the rules of nuclear power engineering design do not permit holes in the regions of longitudinal and circumferential welds of vessel nozzles. At the same time the connection of nozzles to the case is performed

with welding and namely in this unit the maximum stresses are acting during operation and this results in the necessity to carry out low cycle fatigue investigations not only for base metal but also for weld metal.

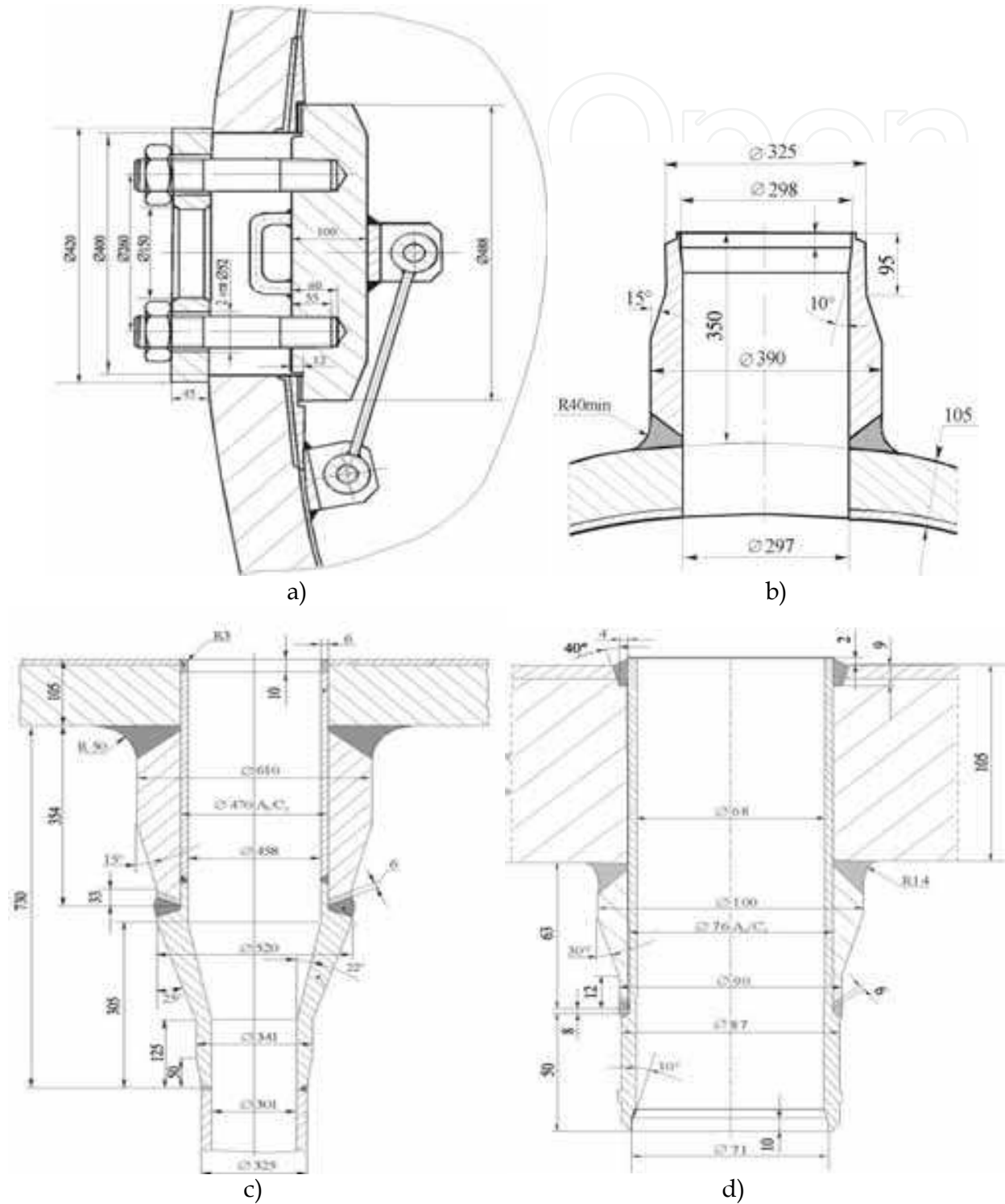

Fig. 3. Sketches of units of connecting various nozzles with steam separator case: a – man-hole; b – nozzles of steam rejection; c – nozzle of down-comer; d – nozzle of steam-water of service lines

2.1 Steam headers of NPP with RBMK-1000 reactors

Collectors are manufactured from 5-7 shells having a diameter of 900 mm (wall thickness – 60-70 mm) and two bottoms (wall thickness – 70-80 mm). The type 22K steel clad with EI-898 (Sv-08Cr18Ni10Mn2Nb) steel is used for the manufacture of collectors. A shell consists of two semi-shells connected with each other using Sv-10Mn2 wire and AN-8M flux. Welding up of nozzles to a collector case is performed manually with YONI-13/55 electrodes.

Headers in-take (Fig.4) and pumping (Fig.5) are made from 5-7 shells (diameter – 900 mm, wall thickness – 70 mm in pumping and wall thickness – 60 mm in-take) and two bottoms (wall thickness 80 mm and 70 mm, respectively for i-take and pumping collectors). The type 22K steel was used for the manufacture of collectors, clad by EI-898 steel. Each shell consisted of two semi-shells, connected with each other by electro-slag welds produced using Sv-10Mn2 wire and AN-8M flux. Welding of nozzles to collector is performed manually with YONI-13/55 electrodes.

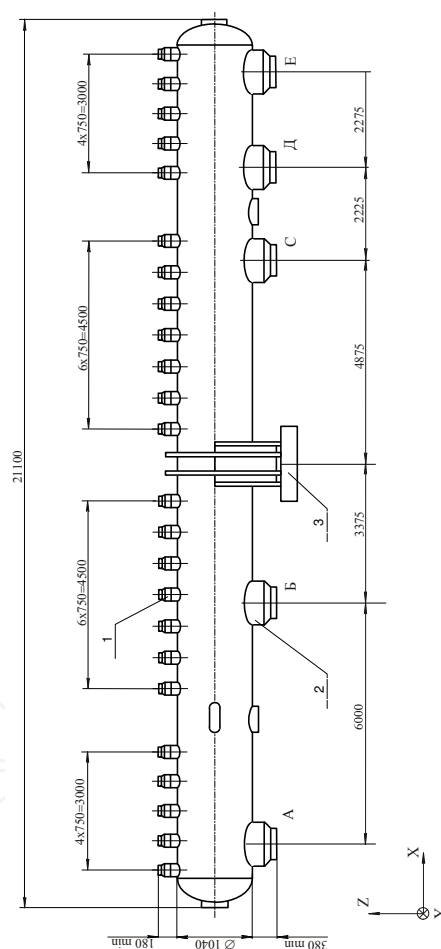

Fig. 4. Sketch of header in-take: 1 – nozzle DN300 to joint with down-comer; 2 – nozzle DN750 to joint with pipe-lines in-take; 3 – central stopper

The design service life of header is 25 years. Geometrical sizes are : diameter 800 mm, length – 21500 mm, wall thickness – 70 (60) mm. Coolant temperature – 290°C, working pressure – 9.1 MPa. For in-take and 7 MPa for pumping collectors, working environment – water of high purity.

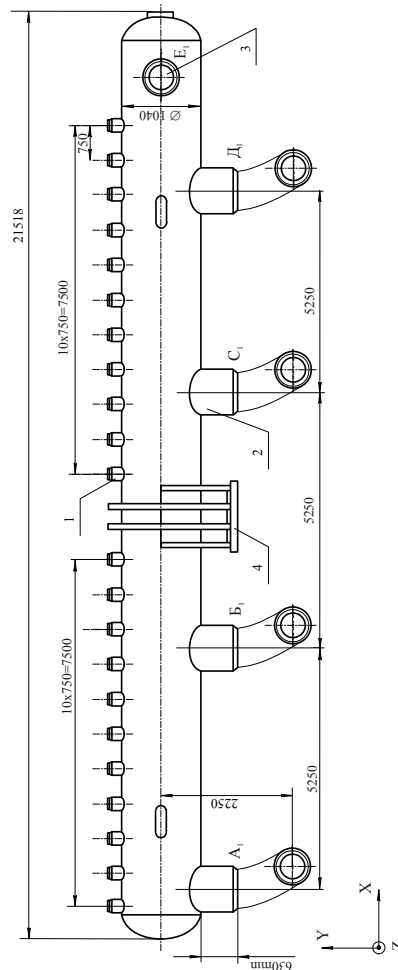

Fig. 5. Sketch of header pumping: 1 - nozzle DN300 to joint RGK; 2 - nozzle DN750 and elbow to joint with pipe-line pumping; 3 - nozzle DN750 to joint with unit between headers in-take and pumping; 4 - central stopper

Requirements for chemical composition and properties of 22K steel used for manufacture of in-take and pumping collectors are presented in Specification TU 24-1-11-427-67. The statistical treatment of certificate data presented in Certificates on the product was carried out. The results of statistical treatment are given below.

2.2 Pipe-lines Du-800 with RBMK-1000 reactors

Tube units of MFCC circuit in-take pipes (diameter - 836 mm, wall thickness - 42 mm) and pumping pipes (diameter - 848 mm, wall thickness - 48 mm) Du-800 (Fig.6). Tube units of the main circulating suction pipes ($\varnothing 838 \times 42 \text{ mm}$) and pressure pipes ($\varnothing 848 \times 48 \text{ mm}$) are made from Du-800 tubes. The main elements of tube units are semi-shells and half-cylinders from 22K steel of the first generation, for which chemical composition and mechanical properties are defined separately. The semi-shells, which are joined with each other using SAW (Sv-08A wire, AN-348A flux) were used for straight section of Du-800 pipe-lines. The elbow sections of Du-800 pipe-line the half-cylinders were used which were also joined with each other by SAW with same welding materials (Sv-08A wire, An-348A flux). For Du-800 pipe-lines of the second generation the French carbon steel Creselso-330E and Japanese 19MN5 steel were used instead of 22K steel.

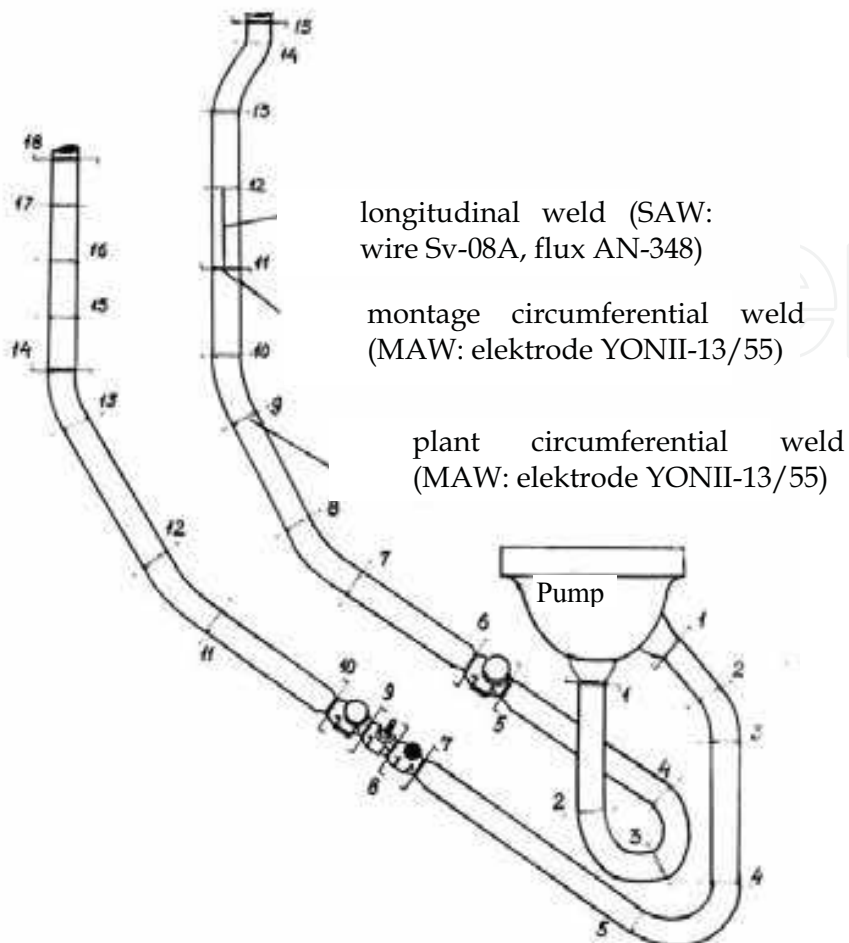

Fig. 6. Sketch of MFCC Du-800

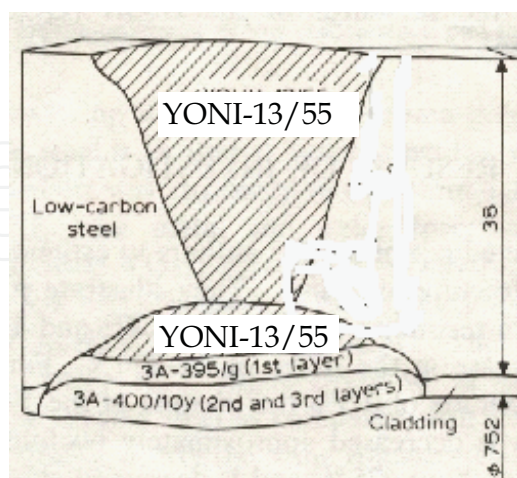

Fig. 7. Sketch of circumferential weld joint

Tube units of the main circulating suction pipes ($\varnothing 838 \times 42 \text{mm}$) and pressure pipes ($\varnothing 848 \times 48 \text{mm}$) are made from Du-800 tubes. The main elements of tube units are semi-shells and half-cylinders from 22K steel of the first generation, for which chemical composition

and mechanical properties are defined separately. The semi-shells, which are joined with each other using SAW (Sv-08A wire, AN-348A flux) were used for straight section of Du-800 pipe-lines. The elbow sections of Du-800 pipe-line the half-cylinders were used which were also joined with each other by SAW with same welding materials (Sv-08A wire, An-348A flux). For Du-800 pipe-lines of the second generation the French carbon steel Creselso-330E and Japanese 19MN5 steel were used instead of 22K steel.

Tube blocks are made from separate units consisting of two semi-elbows $\text{Ø}836 \times 42$ mm and $\text{Ø}848 \times 48$ mm connected with each other with longitudinal weld (SAW Sv-08A wire, AN-348M flux). Separated units are connected with circumferential welds, produced by manual welding with YONI-13/55 electrodes. The type 22K steel clad from the inside with EI-898 (Sv-08Cr18Ni10Mn2Nb) steel (thickness -6 mm) was used for the manufacture of tube units.

2.3 Operating conditions of steam generated systems

The design service life of steam generated systems is 25-30 years. The main factors working in the equipment at operation are:

- elevated temperature is,
- working pressure,
- working environment (water + saturated steam).

The main operating conditions during the design service life are determined by the chief designer of NPP with RBMK-1000 reactors – Research and Development Institute of Power Engineering (RDIPE). The calculated loading regimes of multiple forced circulation circuit (MFCC) are defined for various operating conditions, namely, for normal operating conditions (NOC), breakdown of normal operating conditions and hydraulic tests (HT). They are given in Table 1.

N	Operating conditions	Number of regimes
1. Normal of operating conditions		
1	Normal calculation regime (285°C)	-
2	Planning start (from 40 to 285°C)	300
3	Planning shut down (from 285 to 40°C)	300
4	Cooling with rate 60°C/h (from 285 to 100°C)	100
5	Heating with rate 30°C/h (from 100 to 285°C)	120
6	Operating regime A3 (from 285 to 250°C)	200
7	Normal heating (from 250 to 285°C)	200
2. Break down of normal operating conditions		
8	Cooling with rate 120°C/h (from 285 to 100°C)	20
3. Hydraulic tests		
9	Hydraulic tests during operation	100

Table 1. Calculation loading regimes for MFCC circuit

In total, more than 1000 loading cycles of MFCC are possible during the project service life of NPP with RBMK reactors and this leads to the necessity of studying cyclic strength of

materials from which the separator was manufactured. By this, it is necessary to study fatigue resistance of both base metal and weld metal.

General operation condition of equipment of all generated systems is presented in Table 2.

Equipment	Type of steel	Type of melt	Semi-product	Pressure, MPa	Temperature, °C
SG	22K	OHF, ESM, VAM	Plate, forging	5.7	273
Separator	22K	OHF	Plate	7.6	260-275
Header	22K	OHF	plate	8.5	260-275
MFCC	22K, Crezelso-330, 19MN5	OHF	Sheet Tube Tube	8.5	285

Table 2. General operation condition of equipment

3. Investigated materials

Melting of steel of the given mark (22K) from metallic charge is a task of open hearth process. The composition of metallic charge may vary from 100% pig iron to 100% steel return; in this case the pig iron component may be in liquid and solid state. Materials: ore, pitch, oxygen and fuel. Melted metal is cast. The low part of ingot (zone with negative chemical heterogeneity) and sink head (zone of positive segregation with increased content of sulphur, phosphorus and carbon) are removed and we have open-hearth furnace steel (Zherebenkov, 1980).

Metal of electroslag melting is obtained by melting of bars (rods) of open-hearth melting in the electrical conductive slag. Electroslag process takes place in copper mould cooled by water. Slag is formed at the expense of melting of the flux AHF-6 ($\text{CaF}_2 + \text{Al}_2\text{O}_3$). Metal is obtained of more pure especially on the content of gases because the process of rod metal melting takes place in the protective slag system. Metal of vacuum arc melting is practically formed under the same conditions like the electroslag process. Vacuum is used instead of slag protection and the process itself- electric arc. This makes possible to obtain more pure metal. Steel of special melting methods has more dense uniform oriented structure, containing minimum number of non-metallic inclusions. It is well known that with using melting it is possible to obtain more refined metal containing sulphides less by 40-50%, the number of oxide inclusions and silicates less by 1.5 times as compared with the steel of the same type of open-hearth melting. Ductility and fatigue strength of steel (of these melting for products manufacture the macrostructure of zone with increased etching ability must be limited in sizes and mainly depends on metal crystallization and sulphur content in it. It is necessary to take into account the fact that in ingots from 22K steel of usual melting the off-axis inhomogeneity take place. In some ingots the sources of this inhomogeneity are sulphides "whiskers" which reach considerable sizes. In the process of operation the presence of such defects may result in metal delaminating or plate cracking.

In VAR and ESR due to the oriented crystallization and uniform sulphur distribution across the whole section the "whiskers" are absent, therefore the production of components and

welded joints of pressure vessels with wall thickness equal to 120 mm and more is carried out only from steel of special melting method. The content of gas in metal of special procedures of melting is considerably lower than by the open hearth melting. As concerns density, homogeneity and absence of internal defects the vacuum-arc steel exceeds greatly electroslag, open-hearth and electric furnace steels. Structure and properties of steel depend not only on metallurgical effect of melting but also on a possible variation of its chemical composition within the limits of values permissible in Specification.

The chemical composition of investigated materials is presented in Fig.8. Statistical treatment was applied for more than 200 heats of sheets (plates) which were used at manufacture the steam generator cases.

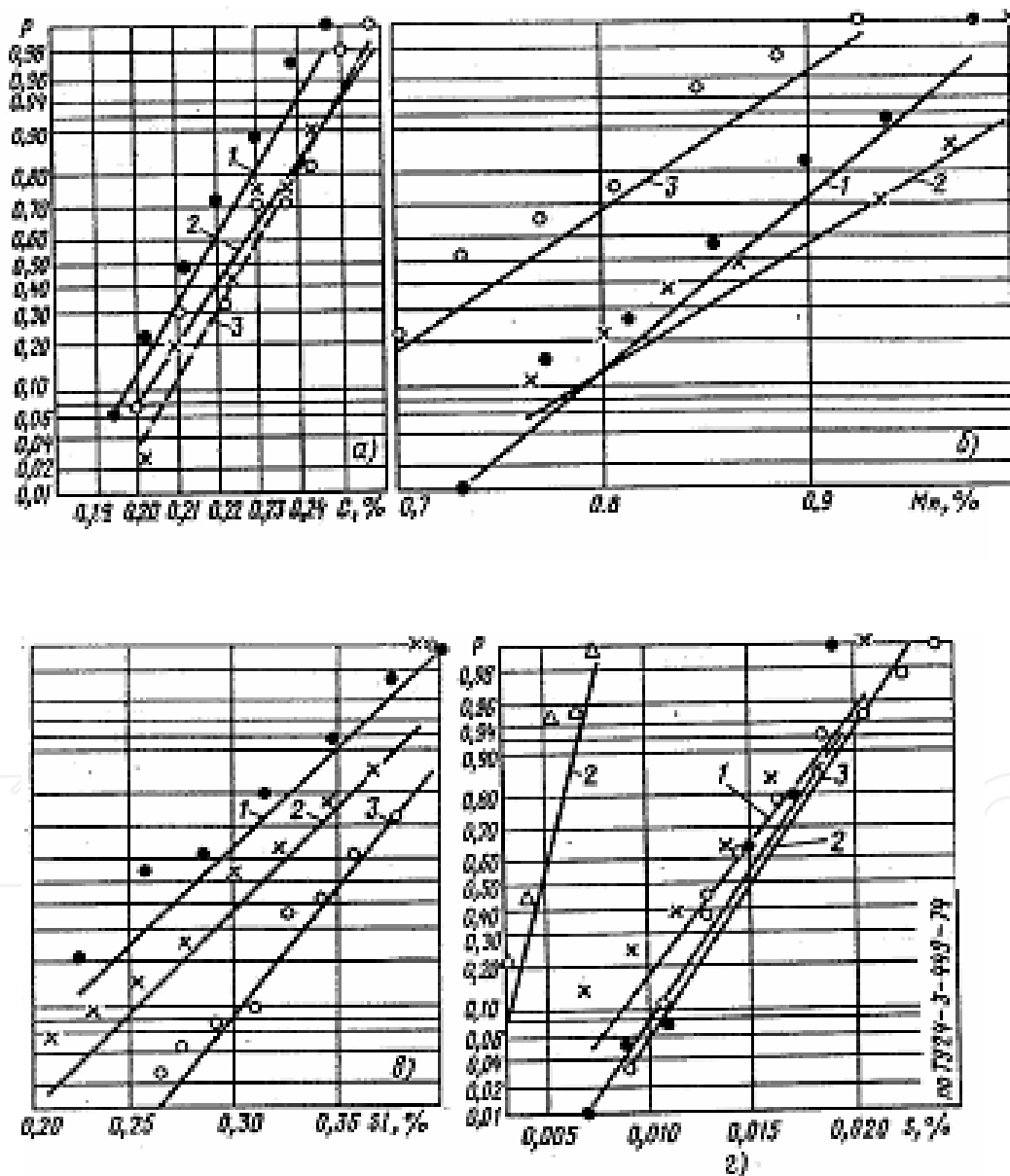

Fig. 8. Distribution of basic elements of 22K steel for various melting methods: ● - OHF; x - VAR; o - ESM (Δ - in ladle).

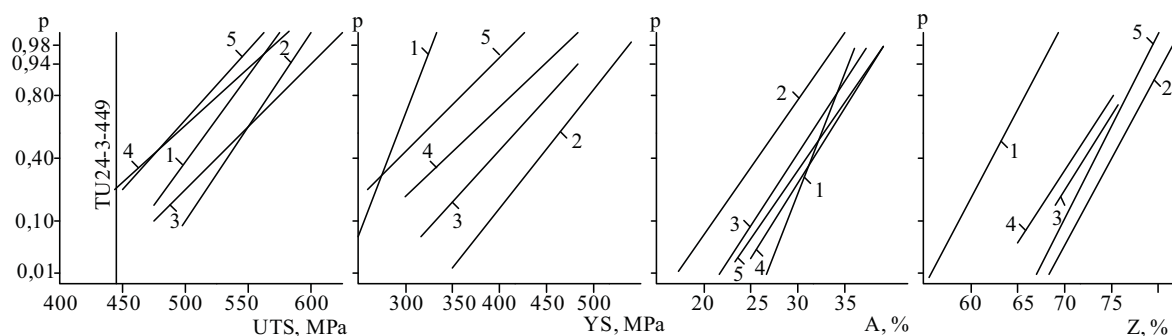

Fig. 9. Distribution of mechanical properties for welded joints of PGV-440 steam generator case: 1 – base metal (22K steel); 2 and 3 – weld metal produced by MAW using YONII-13/45 and YONII-13/55 electrodes; 4 – weld metal produced by SAW using welding wire Sv-08A; 5 – weld metal produced by ESW using welding wire Sv-10Mn2

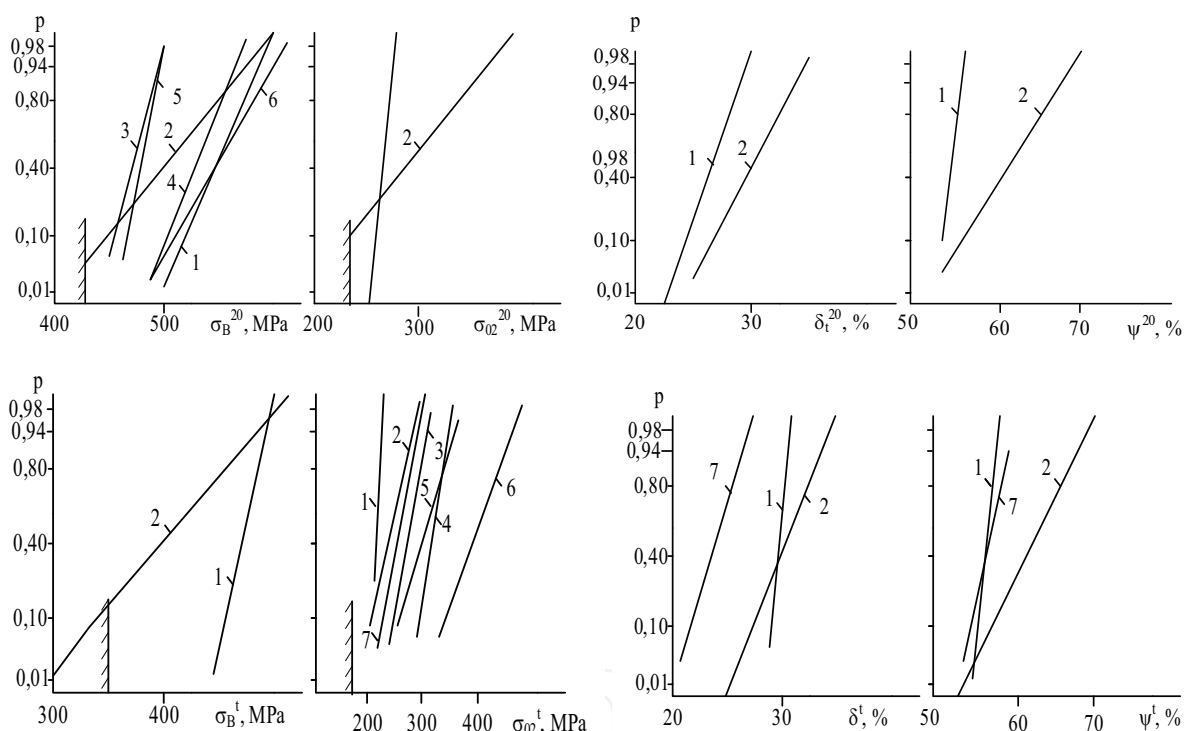

Fig. 10. Distribution of mechanical properties for welded joints on statistical analysis of manufactured RBMK units at room and elevated temperatures: 1 – base metal Crezelso 330E; 2- base metal 22K; 3 – weld metal (SAW wire Sv-08A); 4 – weld metal (SAW wire SF-2); 5 – weld metal (MAW electrode YONII-13/55); 6 – weld metal (MAW electrode ETNA-52HR), 7 – base metal (22K) at 270°C

In Russia eleven power units with RBMK-1000 reactors are being operated at a present time. Four of them (1 and 2 power units of Sosnovy Bor and Kursk NPP) refer to power units of the first generation for which the design service life completed or will complete in the nearest time. Practically all these power units were manufactured on the same technology with the use of same materials delivered on the unitary documentation. Their operating conditions are practically identical. Thus for the elements of multiple forced circulating

circuit (MFCC) namely for steam separators, suction and pressure collectors and Du-800 pipe-lines the carbon steel 22K clad with stainless steel of the type EI-898 (08Cr18Ni10Mn2Nb) and delivered on specification TU24-1-11-427-67 was used. About 30 – 40 steel heats of different melting methods (open-hearth furnace, electroslag and vacuum arc) in the form of rolled plate of different thickness (105 and 115 mm) are used for the manufacture of one separator drum vessel. Approximately the same number of heats but with less thickness of rolled plates (60-80 mm) are used for each collector and with the thickness of rolled sheets from 38 to 48 mm – for tube units. A large bulk of information (more than 500 heats) on properties and chemical composition of MFCC was of interest in view of statistical assessment. The statistical treatment for each equipment element on four power units as a whole was performed and the comparison of properties for different products was carried out.

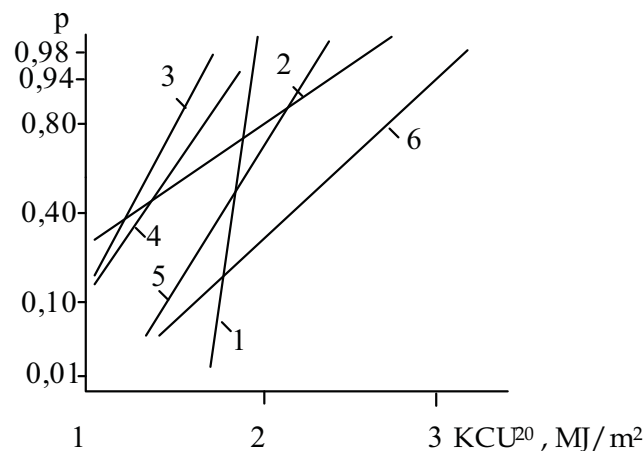

Fig. 11. Distribution of impact strength (KCU) for welded joints on statistical analysis of manufactured RBMK units at room temperature (conventional sign the same as Fig.10)

Separators ($\varnothing 2300 \times 105$ mm, length - 30,5 m) are manufactured from two semi-vessels, each of which consists of some sections [1]. The section includes bottom (thickness - 115 mm) and shells (thickness - 105 mm) or only shells. Each of these elements are assembled from two clad plates, which (in the form of half-cylinders) are joined with longitudinal welds produced by electroslag welding (wire Sv-10Cr2, flux AN-8M). The different number of 22K steel heats (from 30 to 40) is used because one heat (2-4 ingots) may be used for different components of pressure vessel. Post-welding heat treatment is carried out on the following regime: normalization at $930 \pm 10^\circ\text{C}$ exposure for 2.5 hours, cooling in air. Welding of shells with each other and a shell with a bottom using circumferential welds is produced by submerged arc welding (SAW) using Sv-08A wire and AN-348A flux. After welding up circumferential welds the tempering is carried out at $630 \pm 10^\circ\text{C}$, exposure for 4 hours and cooling in air. Welding up of shells to nozzles is performed with manual arc welding (MAW) with the use of the type YONII-13/55 electrode and then the whole pressure vessel is subjected to tempering at $630 \pm 10^\circ\text{C}$ (heating rate - $80^\circ\text{C}/\text{min}$) for a time of 11 hours.

Collectors are manufactured from 5-7 shells having a diameter of 900 mm (wall thickness - 60-70 mm) and two bottoms (wall thickness - 70-80 mm). The type 22K steel clad with EI-898 steel is used for the manufacture of collectors. A shell consists of two semi-shells connected with each other using Sv-10Mn2 wire and AN-8M flux. Welding up of nozzles to a collector case is performed manually with YONII-13/55 electrodes.

Tube units of the main circulating suction pipes ($\varnothing 838 \times 42 \text{mm}$) and pressure pipes ($\varnothing 848 \times 48 \text{mm}$) are made from Du-800 tubes. The main elements of tube units are semi-shells and half-cylinders from 22K steel of the first generation, for which chemical composition and mechanical properties are defined separately. The semi-shells, which are joined with each other using SAW (Sv-08A wire, AN-348A flux) were used for straight section of Du-800 pipe-lines. The elbow sections of Du-800 pipe-line the half-cylinders were used which were also joined with each other by SAW with same welding materials (Sv-08A wire, An-348A flux). For Du-800 pipe-lines of the second generation the French carbon steel Creselso-330E and Japanese 19MN5 steel were used instead of 22K steel.

Earlier as applied to PGV-440 steam generator cases, made from 22K steel the statistical analysis of mechanical properties was performed. There is one publication for components of NPP equipment with RBMK reactors, where the limited information presented. The statistical treatment in more representative volume of data was carried out in this work and the results are given in Tables 3 and 4 only for steam separator (SD) and in Figures 12-15 for tube units and steam separators in comparison with the recommendations of documentation. In this case the law of normal distribution was accepted for the statistical treatment of 22K steel mechanical properties on the certificate data of corresponding product.

Number of SD	Content of elements, %							
	C	Si	Mn	S	P	Cr	Ni	Cu
SD-1	0,21	0,32	0,86	0,012	0,013	0,17	0,26	0,23
SD-2	0,23	0,32	0,86	0,012	0,013	0,17	0,26	0,24
SD-3	0,22	0,31	0,87	0,011	0,013	0,16	0,25	0,22
SD-4	0,22	0,29	0,85	0,011	0,013	0,15	0,25	0,22
SD-5	0,22	0,30	0,86	0,011	0,013	0,18	0,25	0,23
SD-6	0,23	0,30	0,85	0,013	0,012	0,18	0,25	0,22
SD-7	0,22	0,30	0,82	0,013	0,012	0,18	0,23	0,21
SD-8	0,21	0,28	0,82	0,012	0,013	0,19	0,23	0,20
SD-9	0,22	0,29	0,87	0,013	0,013	0,21	0,23	0,20
SD-10	0,22	0,30	0,87	0,015	0,013	0,20	0,23	0,19
SD-11	0,22	0,30	0,88	0,013	0,013	0,21	0,22	0,19
SD-12	0,225	0,32	0,86	0,012	0,013	0,17	0,26	0,23
SD-18	0,22	0,31	0,86	0,012	0,011	0,20	0,24	0,20
SD-19	0,22	0,31	0,85	0,012	0,012	0,21	0,23	0,21
SD-20	0,23	0,32	0,86	0,014	0,013	0,19	0,19	0,18
SD-23	0,22	0,33	0,84	0,015	0,014	0,17	0,18	0,18
TU	0,19-0,26	0,20-0,40	0,75-1,0	$\leq 0,030$	$\leq 0,030$	$\leq 0,40$	$\leq 0,30$	$\leq 0,30$

Table 3. Chemical composition of 22K steel for steam separator of NPP units with RBMK-1000 reactors of the first generation

As can be seen from the presented in Figs.12 and 13 data the strength properties (average values, dispersion) at room temperature for the metal of separator and tube units does not practically differ and the values (UTS and YS) required on documentation (Specification TU24-1-11-427-67) are provided with a high degree of reliability (more than 99%). As

concerns the ductility characteristics the results in view of meeting requirements of documentation appeared somewhat different. The differential curves for elongation (A) and impact strength (KCU) at 20°C confirm this idea.

Number of SD	At 20°C				At 350°C
	UTS MPa	YS MPa	A %	KCU J/cm ²	YS MPa
SD-1	534	354	25,5	176	249
SD-2	537	342	25,1	175	244
SD-3	528	335	25,7	184	238
SD-4	526	340	25,2	186	244
SD-5	523	337	27,5	183	249
SD-6	535	349	24,6	169	246
SD-7	520	328	25,4	174	245
SD-8	515	319	25,1	170	238
SD-9	528	346	27,4	180	248
SD-10	530	347	29,9	158	262
SD-11	533	343	29,7	177	251
SD-12	525	343	32,1	149	254
SD-18	523	304	31,5	144	254
SD-19	507	309	31,4	157	237
SD-20	518	316	31,8	170	234
SD-23	511	321	32,1	176	232

Table 4. Mechanical properties of steam separator

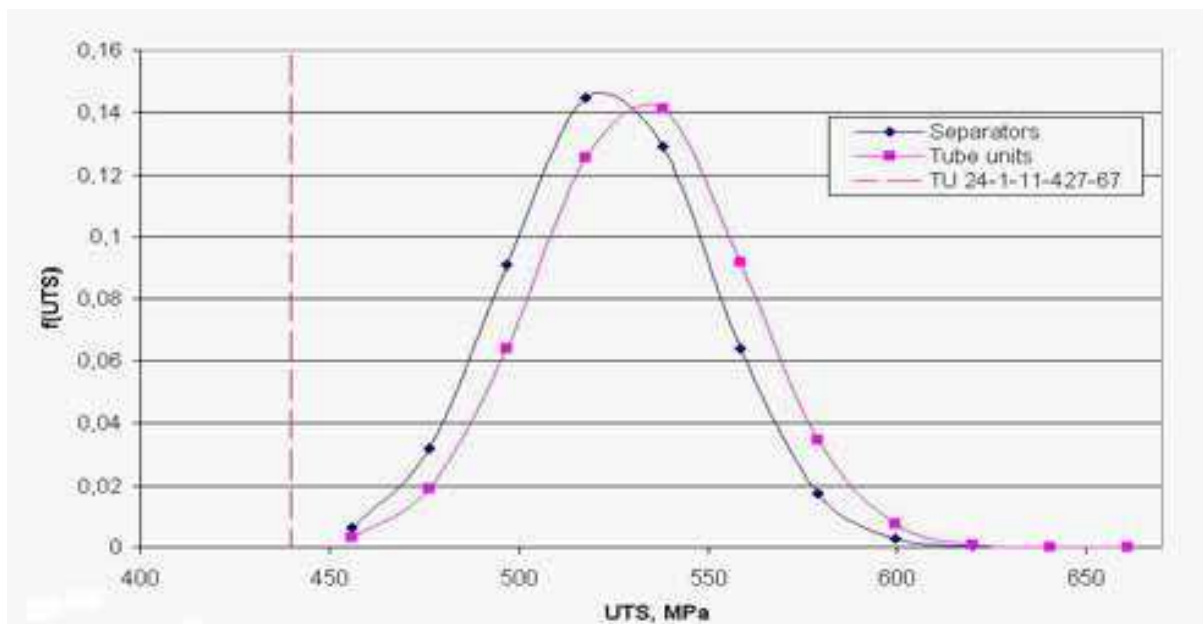

Fig. 12. Comparison of theoretical curve of ultimate tensile strength distribution at 20°C for separators and tube units with requirements of specification TU 24-1-11-427-67

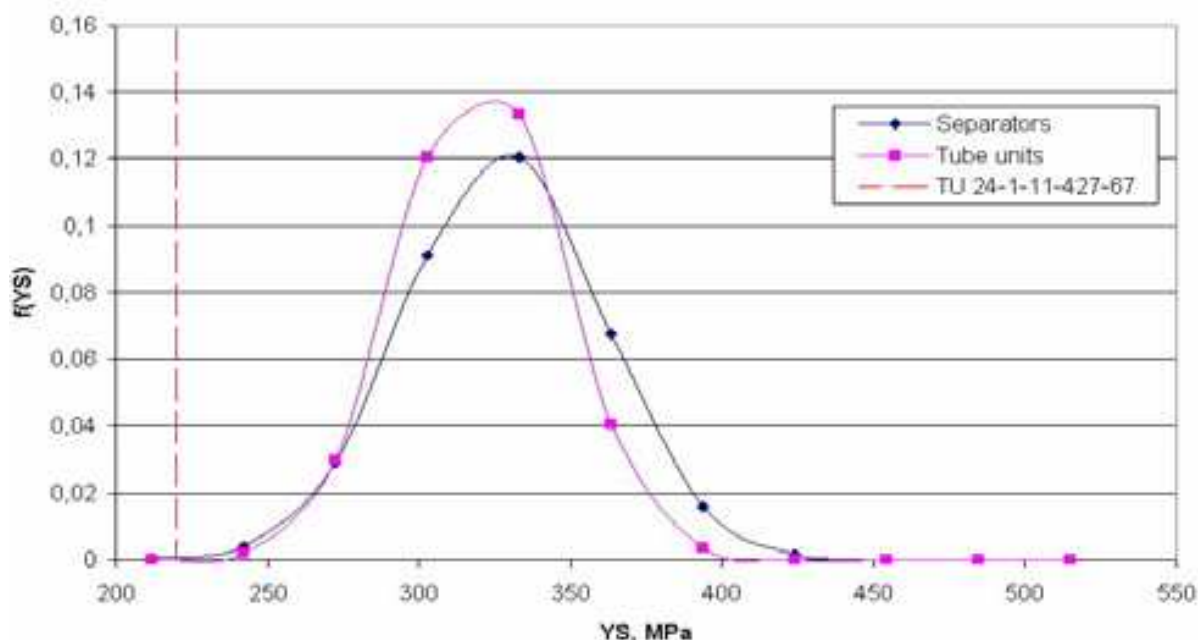

Fig. 13. Comparison of theoretical curve of yield strength at 20°C for separators and tube units with requirements of specification TU 24-1-11-427-67

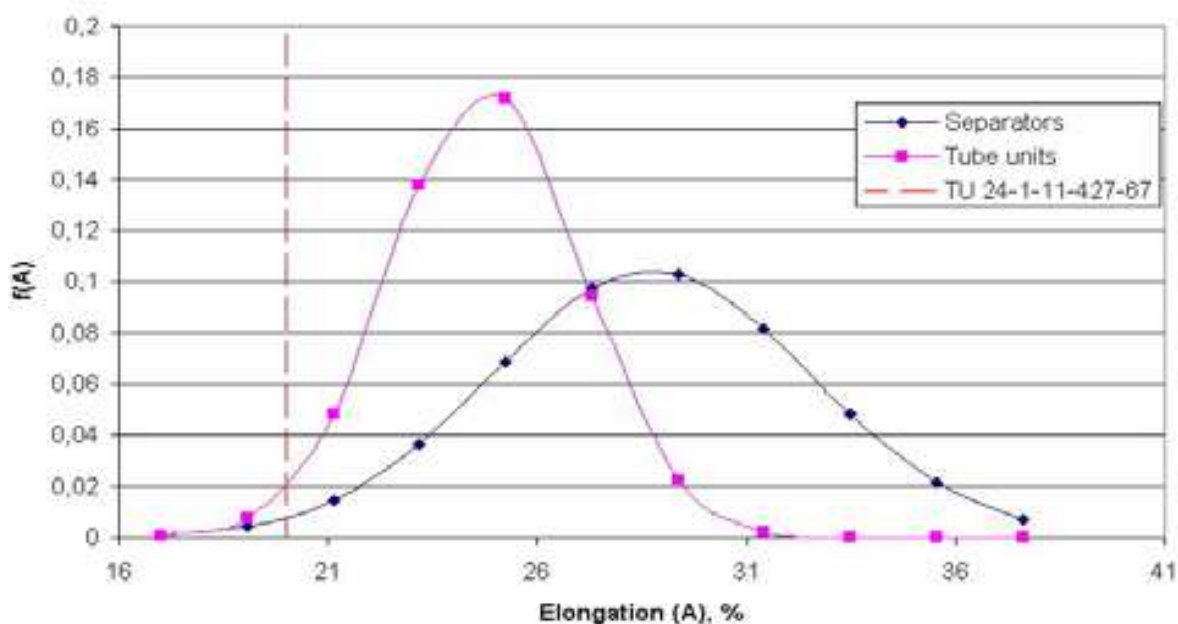

Fig. 14. Comparison of theoretical curve of elongation distribution at 20°C for separators and tube units with requirements of specification TU 24-1-11-427-67

The characteristics presented in Figs. 14 and 15 reflect in a higher degree the ductile properties of material at room temperature. The relative elongation and impact strength on Manager specimens rather relates to qualitative characteristic and usually are not used by the conduction of strength calculations. At the same time we may note than A and KCU for material of tube units are a few not so good than for steel of the same separator type, and the theoretical curves of distribution of these characteristics confirm it. The same may be said about the value of yield strength at elevated temperature.

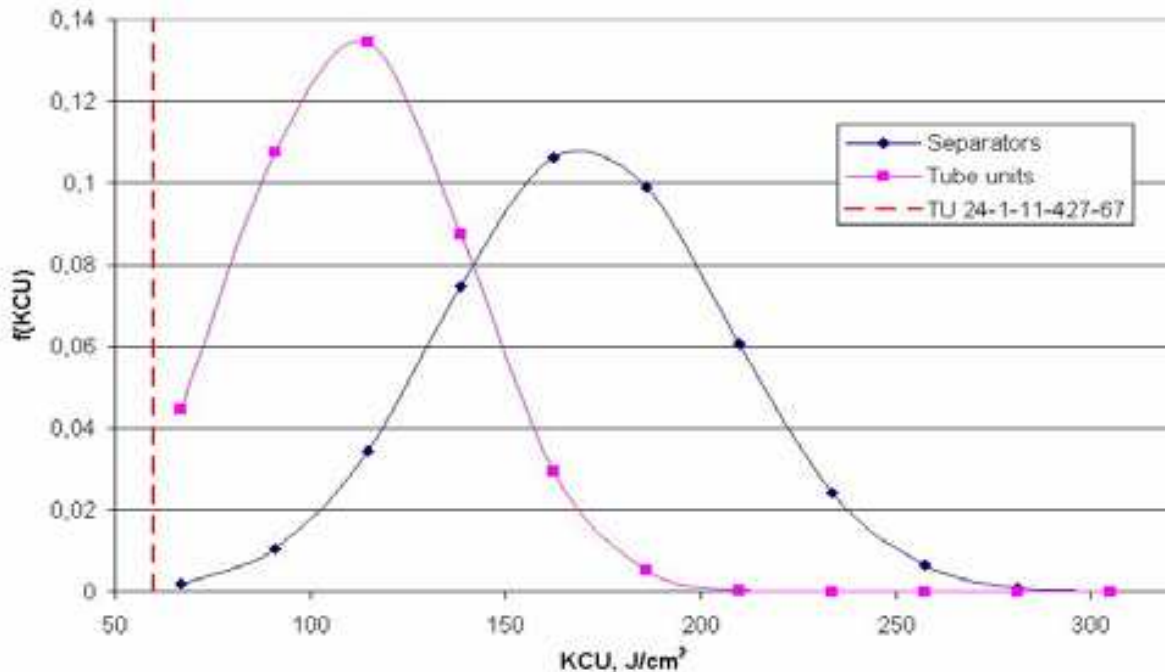

Fig. 15. Comparison of theoretical curve of impact strength at 20°C for separators and tube units with requirements of specification TU 24-1-11-427-67

4. Requirements for stability of properties during operation

In accordance with item 7.6.3 (PNAE G-7-008-89, 1990) the inspection of equipment mechanical properties is carried out using destructive and non-destructive techniques. It shall be performed out not rarely than at interval of 100000 hrs of operation for NPP with water-cooled and water-moderated reactors (WWER) and water-graphite reactors (RBMK), and at intervals of 50000 hrs for fast reactors with liquid metal coolant (BN). This order of assessment of actual properties of material in the process of operation was introduced in the regulations of NPP works for the purpose of safety provision. This requirement was associated with the necessity to obtain valid information about material ageing in the NPP equipment operation and on the base of this information to estimate the change of strength margin coefficient used in design with regard to variations of initial mechanical properties of materials. It is possible to assess various methods using surveillance specimens, part of materials removed from the inner surface of equipment (RPV, SG and other large cases) or a part of the piping. For RPV as a rule the variation of mechanical properties are examined with the use of surveillance specimens which are tested not less than six times during the calculated design lifetime of reactor.

By the development of the first normative documents for NPP arrangement and safe operation of other equipment and piping of NPP PNAE G-7-008-89 the regulation about a periodical inspection of steel mechanical properties on the base of test results of specimens removed from pipe-lines was introduced. It makes possible to follow the actual state of pipe-lines and variation of mechanical properties of base metal and welded joints under the influence of real operating conditions (elevated temperature, pressure, corrosive medium) by all regimes. It is natural to suggest that due to the operation influence (static and cyclic loads, a prolonged effect of elevated temperatures and coolant) the degradation of material mechanical properties is possible. Of course in accordance with (PNAE G-7-002-86, 1989)

these factors should be taken into consideration in the condition by calculations. The values of the mechanical properties of NPP materials during the whole designed lifetime is estimated by definite requirements which are presented in Table 5.

BASE Material	Part of welded joint	At 20°C				At 350°C				T _{KO} , °C
		UT MPa	YS, MPa	A,%	Z,%	UTS MPa	YS, MPa	A,%	Z,%	
22K	Base metal	430	215	18	40	392	177	18	40	+40
	SAW Sv-08A	353	196	20	55	314	176	13	50	0
	MAW YONII- 13/45	353	216	20	55	314	176	20	55	+20
	YONII- 13/55	431	255	20	50	372	216	18	50	+30
	ESW Sv-10Mn2	372	216	16	50	=	196	-	-	+40

Table 5. Requirements of mechanical properties for NPP equipment materials

At a present time a great experience has been accumulated on the determination of ageing processes under conditions of NPP pipe-lines operation which has shown that the steel mechanical properties variations of pipe-lines are small and are within the limits of measurement accuracy. Such results might be expected for operation conditions of pipe-lines in light water pressurized reactors thanks to:

- steady structure equilibrium of structural steels used for pipe-lines which should provide a relative stability of steel structure and properties during operation;
- a low level of membrane stresses (margins $n_{0.2}=1-5$ and $n_B=2.6$) assuring the operation of the main metal mass in the elastic area;
- in principle the steels considered are cyclically stable and this makes the processes of cyclic hardening insignificant.

The aim of this presentation is as follows:

- generalization of experimental results and analysis their stability;
- determination of a possible decrease of inspection scope of mechanical properties under NPP conditions up to a complete or partial cancellation, decrease or cancellation of metal removal from real pipe-lines considering the fact that the removal of specimens from real pipe-lines did not promote the increase of pipe-lines quality and reliability because the repair process results in the increase of defective pipe-lines welds which are performed under assembling conditions with radiation influence

Based on the operation conditions by the conduction of strength calculations of equipment it is necessary to take into account the variation of properties due to the action of the main damaging factors during the designed service life (30 years). They are:

- structural changes and degradation of material properties caused by a prolonged influence of elevated temperatures;
- generation of cracks caused by low cycle loads by a combined action of cyclic (including thermal cycles) and static loads;

- embrittlement of material and welded joints due to the influence of static and cyclic loads;
- corrosion damage due to a prolonged effect of coolant.

Ageing is defined as the metal state variations which may take place in the course of time under external influences or without them. The ageing by heat treatment, a prolonged temperature influence, by strain aging, under operational and thermo-mechanical influences, etc. are distinguished. As ageing occurs, as a rule, mechanical properties of metal are degraded. Taking into account an obligatory execution of the item 7.6.3 PNAE G-7-008-89 a lot of tests of specimens removed from piping after operation 100000 hrs were carried out in our country and also other countries and large number of data were accumulated. Nevertheless the published information about the effect of operational factors on material mechanical properties is quite limited. The first publication was devoted to the investigations performed for the main circulating piping from stainless steel intended for units 3 and 4 of Novo-Voronezh NPP (Gaponov, 1989). Such results for piping made from carbon steels appeared later and are presented in (Timofeev, 2004). The information accumulated for the last 15 years on the investigation of the state of base metal and welded joints after a prolonged operation (100000 hrs and more) makes possible to analyze the variation of strength and ductility characteristics. Besides there are some publications (Timofeev, 2009) and (Petrov, 2004)) about thermal ageing of RPV steels and their welded joints. This paper presents the analysis for carbon steel and their welded joints mainly as applied to operation conditions of NPP.

5. Thermal ageing

The first results for piping made from carbon steels appeared later and they are presented (Gaponov, 1989) and (Beznosikov, 1995). The information accumulated for the last 15 years on the investigation of the state of base metal and welded joints after a prolonged operation (100000 hrs and more) makes possible to analyze the variation of strength and ductility characteristics. The mechanical properties of carbon steels of the type 20 and 22K and their welded joints produced using manual arc welding (MAW) with covered electrode after a prolonged (100000 hours) influence of operation temperatures up to 290°C practically do not change. This tendency for base metal is confirmed up to 200000 hours, i.e. to the designed service life of piping (30 years) makes possible to correct item 7.6.3 "Rules of arrangement and safe operation of equipment and piping of NPP" as concerns the inspection periodicity of mechanical properties with destructive techniques at the NPP in the period of planned maintenance repair. As the degradation of mechanical properties of carbon steel is practically absent during the designed service life was recommends to carry out inspection after 200000 hrs of operation and not 100000 hrs and the basis for this conclusion was presented. On the base of earlier performed investigations (Karzov, 1993) we can mention a high stability of strength and ductile properties of this steel at 20°C independent of temperature and a prolonged thermal exposure. In this case the level of mechanical properties after thermal exposures does not decrease below the normative requirements for the initial period of operation. At the same time it should be noted the insignificant decrease of impact strength of steel by Menage specimens tests after the exposure during 10000 hrs at the thermal temperature 450°C if we compare with value according to the normative requirements. The critical transition temperature of 22K steel is also nearly stable after thermal ageing at studied temperatures (except 340°C) on the duration 100000 hrs.

A section of Du-800 piping was cut out from Sosnovyj Bor NPP, operated under the influence of elevated temperatures and pressure for nearly 30 years, in order to assess the mechanical properties variation of piping material after a prolonged operation. Specimens were made from base metal (22K steel) of the removed from piping (0828x38 mm) element and tested by one-fold tension. Fig.16 presents the summarized results which make possible to judge about the relation between actual properties of materials with the requirements on the values of characteristics specified by the technical normative documentation and it was accepted to conduct strength calculations by the chief designer of the power plant. In this case the actual values in as-produced condition are accepted with regard for their distribution according to the investigation data in (Timofeev, 2004) after 100000 hours of operation - data of NPP reports for various power units and after 30-year period of operation - test results of specimens removed from the piping of unit 1 Sosnovyj Bor NPP (Karzov, 1999).

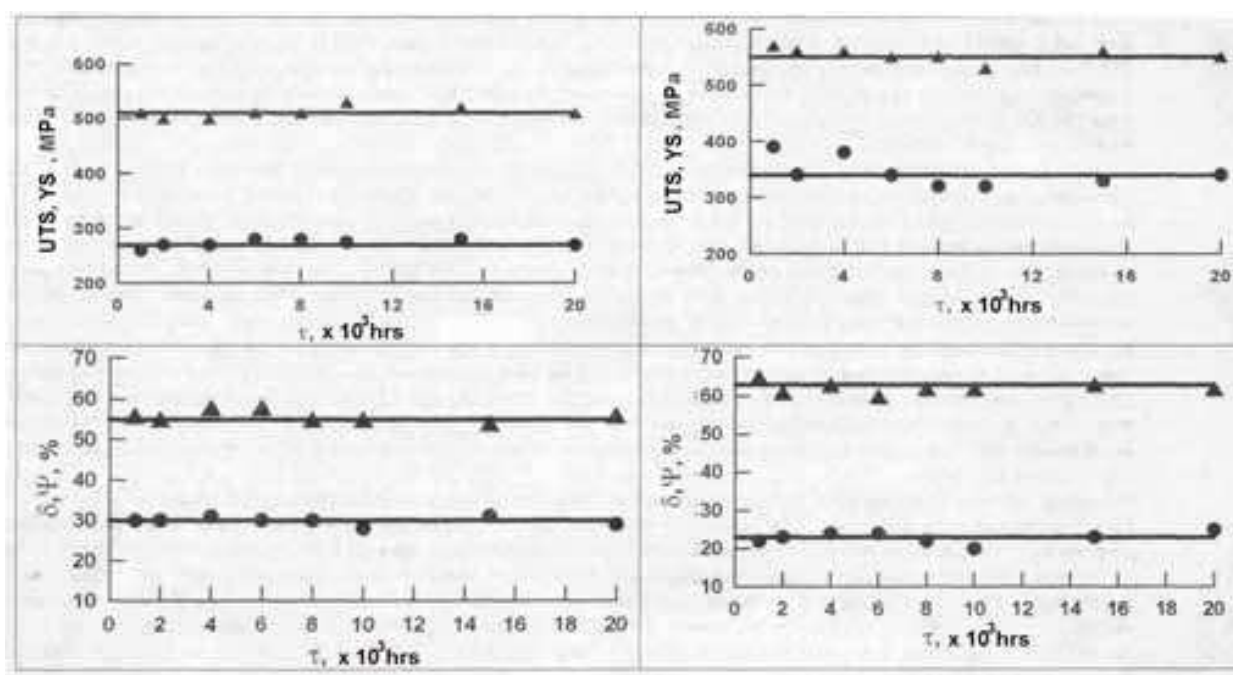

Fig. 16. Variation of mechanical properties for 22K steel (left) and its weld metal (right) produced by MAW electrode YONII-13/45 at room temperature for different time of thermal ageing

As follows from Fig.16 the variations of mechanical properties of both base metal and weld metal during the designed operation time of pipe-lines made from carbon steels as related to these materials in as-produced condition (before operation) practically do not occur and thus margins of static strength accepted at the project stage are retained. This conclusion may be drawn for margins of cyclic strength because the values of material reduction of area independent of the thermal ageing duration is actually at the same level as in as-produced condition.

The obtained experimental data for 22K steel show that after the operation time (30 years) the mechanical properties are appreciably higher than required by the documentation TU-24-3-449-74. And this is the evidence for the fact that a prolonged heating of 22K steel within

the range of operation temperatures and operating pressure does not result in an appreciable degradation of properties.

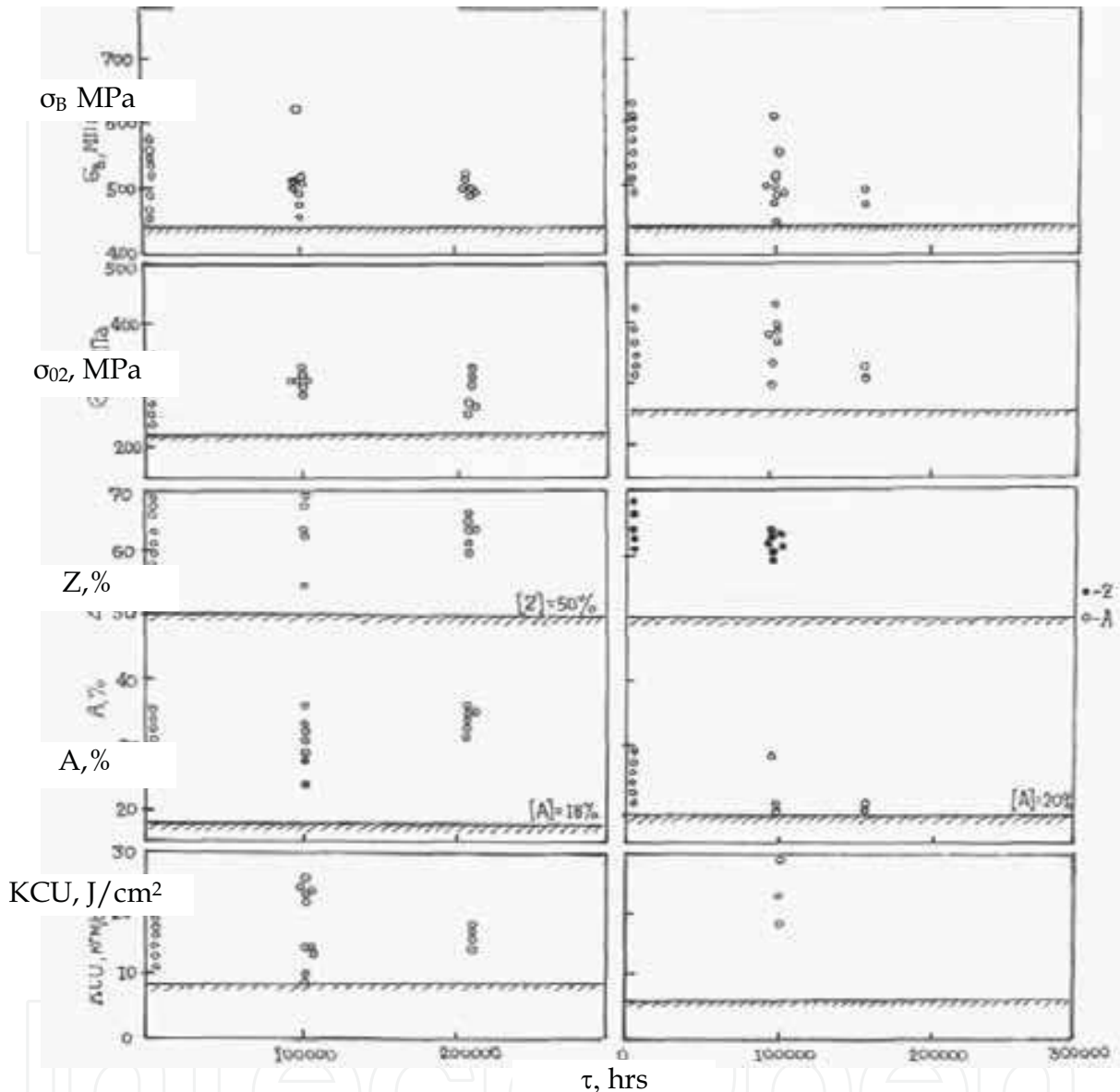

Fig. 17. Summarized data of effect of thermal ageing on mechanical properties of welded joints for carbon steel type 22K

6. Strain ageing

The equipment and pipe-lines of NPP manufactured in carbon steel are operated at elevated temperatures up to 360°C that lay within the temperature range of dynamic strain ageing which manifests itself in strength properties improvement and plastic properties deterioration under single loading (Karzov, 1993). The variation of mechanical and fatigue properties of steels in the temperature range from 20 to 400°C can be attributed to different reasons, including carbon and nitrogen atomic hardening around screw dislocations, strain

ageing due to internodes carbon and nitrogen atoms, and also to dislocation precipitation of carbide and nitride particles.

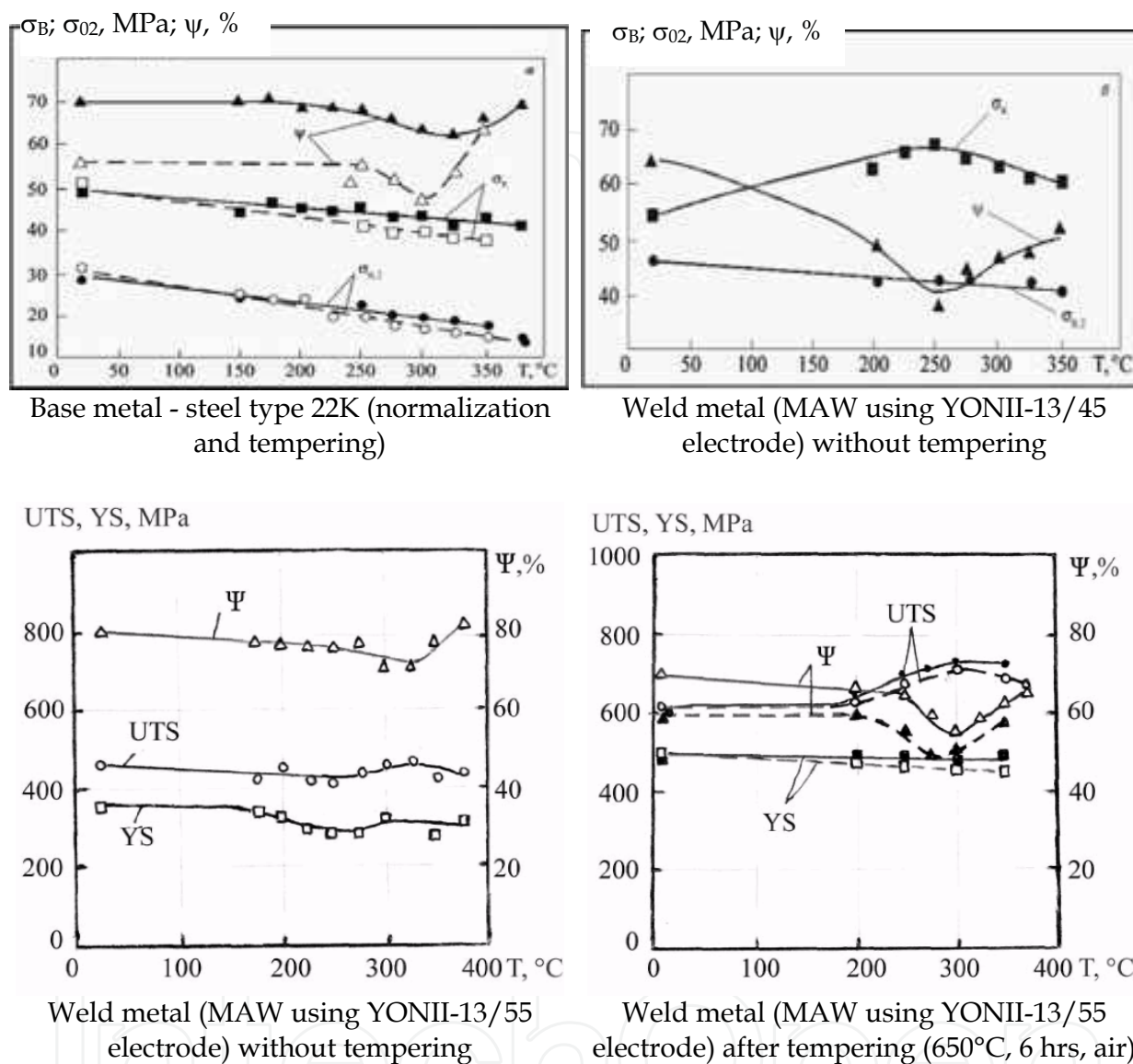

Fig. 18. Variation of mechanical properties for base and weld metal of 22K welded joints in BOL ($\tau = 0$) and EOL ($\tau = 30$ years)

From these assumptions it is noted in Ref. [9] that the effect of mechanical and fatigue properties variation must be most evident in welded joints since high heating temperatures in welding and subsequent fast cooling enhance super saturation and ageing. Some investigations carried out in our country during 1970 are devoted to this problem. The variation of mechanical properties in the temperature range from 20°C up to 400°C was investigated for different materials (base metal and welds, Fig 18) under single tension at the strain rate of $150 \times 10^{-4} \text{ s}^{-1}$ (the rate applied in low-cycle fatigue tests). It has been established that strain ageing shows up most vividly in reduction of area Z (Daunene, 1975) and (Daunis, 1982).

7. Low cycle fatigue

Experimental results of low cycle fatigue tests for low carbon steel of grade 22K are shown in Fig. 19. Here data of 22K steel after various procedures (melting in open-hearth furnace, electro-slag and vacuum-arc re-melting) is presented. These data were received for forging, sheet rolling and a pipe at room and elevated temperatures. The thickness of semi-products is changed from 38 to 120 mm. All experimental points are located in a fairly narrow scatter band and, therefore, can be referred to a single general population. This fact enabled us to construct a mean-square relation (solid line 4) and bound areas of the 95% confidence interval (dashed lines 2 and 3) for the entire array of experimental data. The mean-square relation is described by the formula $\log \varepsilon_a = 1.29154 - 0.45116 \log N$. Comparison of this relation and the lower envelope of the common data array at 20°C with the design curve of fatigue for carbon steels (line 1) shows that the values of safety factors $n_\sigma=2$ and $n_N=10$ by the lower envelope (line 3) are provided for the base metal (Timofeev, 2005).

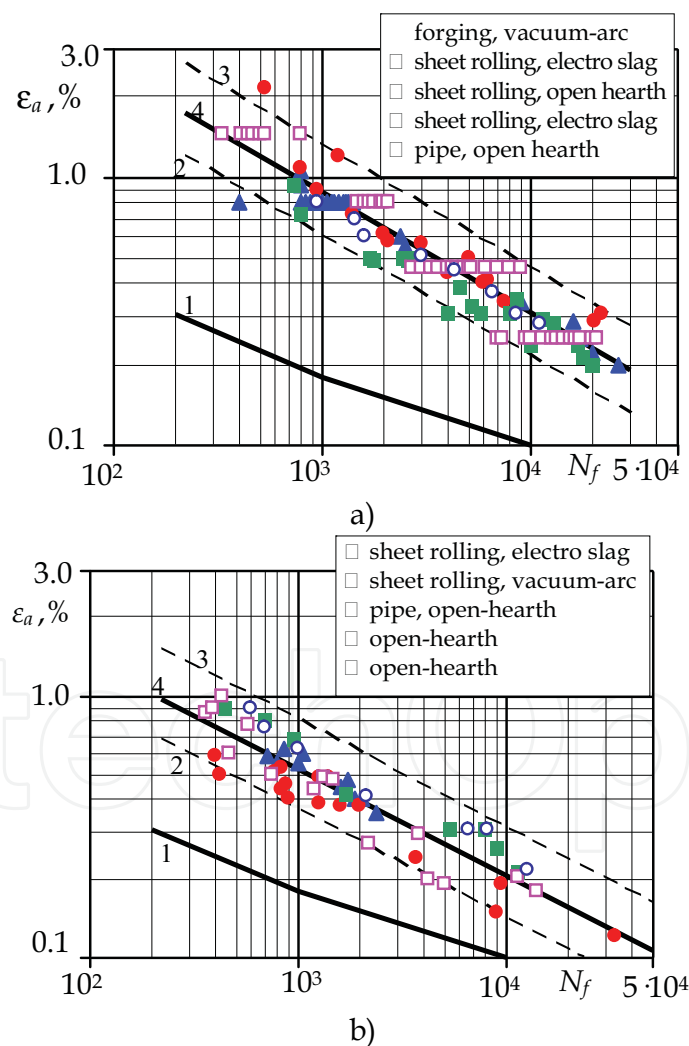

Fig. 19. Low-cycle fatigue curves of 22K steel of different melting: a – at room temperature; b – at 350°C temperature. Dots – experimental data for different heats of steel; 1 – Reference curve for low alloyed steel; 2 and 3 – data falling outside the 5 and 95% tolerance bounds for steel at 20°C; 4 – mean square dependence for the scatter band for steel at 20°C

8. Conclusion

The generalization of experimental investigation results performed in our country and devoted to the effect of thermal ageing at 250-350°C on mechanical properties of carbon steel and its welds has shown that variation of structure, strength and ductility characteristics, practically, does not occur during the 30-years service life. There are only some deviations from the general tendency, however they are small and always within the limits of the accuracy of characteristic measurement on the accepted determination procedure.

A prolonged operation experience of carbon steels in the composition of equipment of the LWR confirmed the absence of variation of mechanical characteristics of the carbon steel. Some decreasing of reduction of area materials is observed because some of them (weld metal without tempering) have sensitivity to strain ageing.

9. References

- Beznosikov S.A., Mjasnjankin A.I., Veselovsky V.F., Timofeev B.T., Filchagin Yu. (1995). Assessment of State of Properties for Base Metal and Welds of NPP Pipe-Lines after Prolonged Operation. *Proceedings of Workshop "Ageing of NPP Component Materials"*, St-Petersburg, 28 February-2 March 1995, p.221-232.
- Dauniene S.A., Karzov G.P, Timofeev B.T., Timofeeva A. (1975). Experimental Assessment of Sensitivity of Weld Metal to Strain Ageing. *Sudostroitel'naja Promyshlennost, serja "Svarka"*, issue 20, p. 17-21.
- Daunys M.A., Dauniene S.A., Timofeev B. (1982). Properties of Welded Joints at Strain Ageing during Low Cycle Fatigue. *Svarochnoe Proizvodstvo*, No. 12, 1982, p. 12-14.
- Gaponov, A. (1989). The State of the Du-500 Piping of the WWER Main Circulating Circuit after 100000 hrs Operation. *Teploenergetika*, No.1, p.43-44.
- Karzov G.P., Timofeev B. (1999). Assessment of Degradation of Mechanical Properties of Steels and Weldments for Pressure Vessels and Piping. *Proceedings of the Joint EC - IAEA Specialists Meeting on NDT "Methods for Monitoring Degradation"*. 10-12 March 1999, Petten, p.94-103.
- Karzov G.P., Timofeev B.T., Filchagin Yu.G. The Influence of Prolonged Exposure to Operating Temperatures and Strain Aging on the Material Properties of Nuclear Power Plant Reactor Vessels and Piping. *International Journal of Pressure Vessel and Piping*. Volume 53, No.2, 1993, p.195-216.
- Kashirin V., Krasnov A., etc. (2004). Problems and their Solution by the Substantiation of a Possible Service Life Extension of Steam Separators and Collectors of Unit 1 Sosnovy Bor NPP. *Proceedings of Int. Conf. "Channel reactors: Problems and Solution"*, Moscow, 8p.
- Petrov V.A., Timofeev B.T., Shalygin A.S. (2004). Influence of Prolonged Operation Time on Mechanical Properties of NPP Piping Welded Joints from Carbon Steels. *Proceedings of the Tenth Workshop "Provision on Safety and Economy of Power Engineering Equipment"*. 23-26 November 2004, St. Petersburg, p.175-180.
- PNAE G-7-002-86. *Strength Calculations Norms for Nuclear Power Plant Equipment and Piping*. Energoatomizdat, Moscow, 1989, 525p.
- PNAE G-7-008-89. *Regulations of the NPP Equipment Installation and Piping Safe Operation*. Energoatomizdat, Moscow, 1990, 168p.

- Timofeev B.T., Shalygin A. (2004). Assessment of Variation of Properties for Welded Joints of Piping from Carbon Steels during Design Lifetime. *Voprosy Materialovedeniya*, No.3(39), p.54-61.
- Timofeev B., Bazaras Z. (2005). Cyclic Strength of the Equipment of Nuclear power Plants Made of 22K Steel. Cyclic Strength of the Equipment of Nuclear power Plants Made of 22K Steel. *International Journal Materials Science*, 2005, vol.41, No.5, p.680-685.
- Timofeev, B. (2009). Thermal Ageing of Russian RPV Materials Used for NPP with LWR. *Proceeding of the 15 Int. Conf. "Building Services > Mechanical and Building Industry Days"*. 15-16 October 2009, Debrecen, Hungary. Mechanical Engineering Section, p.55-66.
- Timofeev, B.; Zhrebekov, A.; Chernenko, T. (1982). *Statistical Approach to Estimation Quality and Properties of Welded Joints*. Leningrad, LDNTP, 23p.
- Vaseneva, N.; Generalova, S.; Timofeev, B.; Chernenko, T. (1990). Properties of Steel and Welded Joints of Pipe-Lines of Circuit MFCC for NPP with RBMK Reactors of First and Second Generations. *Sudostroitel'naya promyshlennost*, Issue Number 9 "Welding", p.29-34.
- Zhrebekov A., Timofeev B., Chernenko T.. (1979). Dispersion of Mechanical Properties of Welded Joints from the Type 22K Steel. *Scientific-Technical Collection "Problems of Shipbuilding"*. Ser. Welding, issue 28, 1979, p.56-59.
- Zhrebekov A.; Sobolev Yu.; Timofeev B.; Zemzin V. (1980). Comparative Assessment of Properties and Composition of the Used in Power Mechanical Engineering 22K Steel Depending on Melting Method. *Energomashinostroenie*, No.11, 1980, p.20-23.

IntechOpen

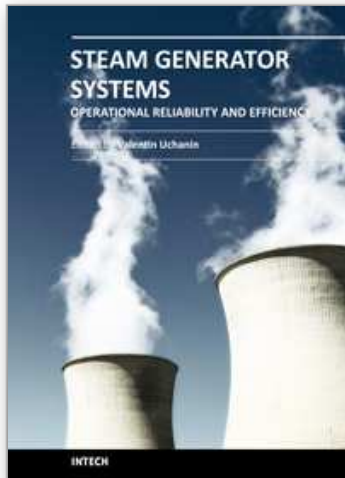

Steam Generator Systems: Operational Reliability and Efficiency

Edited by Dr. Valentin Uchanin

ISBN 978-953-307-303-3

Hard cover, 424 pages

Publisher InTech

Published online 16, March, 2011

Published in print edition March, 2011

The book is intended for practical engineers, researchers, students and other people dealing with the reviewed problems. We hope that the presented book will be beneficial to all readers and initiate further inquiry and development with aspiration for better future. The authors from different countries all over the world (Germany, France, Italy, Japan, Slovenia, Indonesia, Belgium, Romania, Lithuania, Russia, Spain, Sweden, Korea and Ukraine) prepared chapters for this book. Such a broad geography indicates a high significance of considered subjects.

How to reference

In order to correctly reference this scholarly work, feel free to copy and paste the following:

Zilvinas Bazaras and Boris Timofeev (2011). Effect of Long-Term Thermal Influence on Mechanical Properties of Welded Joints for Carbon Steels used in Power Engineering, *Steam Generator Systems: Operational Reliability and Efficiency*, Dr. Valentin Uchanin (Ed.), ISBN: 978-953-307-303-3, InTech, Available from: <http://www.intechopen.com/books/steam-generator-systems-operational-reliability-and-efficiency/effect-of-long-term-thermal-influence-on-mechanical-properties-of-welded-joints-for-carbon-steels-us>

INTECH

open science | open minds

InTech Europe

University Campus STeP Ri
Slavka Krautzeka 83/A
51000 Rijeka, Croatia
Phone: +385 (51) 770 447
Fax: +385 (51) 686 166
www.intechopen.com

InTech China

Unit 405, Office Block, Hotel Equatorial Shanghai
No.65, Yan An Road (West), Shanghai, 200040, China
中国上海市延安西路65号上海国际贵都大饭店办公楼405单元
Phone: +86-21-62489820
Fax: +86-21-62489821

© 2011 The Author(s). Licensee IntechOpen. This chapter is distributed under the terms of the [Creative Commons Attribution-NonCommercial-ShareAlike-3.0 License](#), which permits use, distribution and reproduction for non-commercial purposes, provided the original is properly cited and derivative works building on this content are distributed under the same license.

IntechOpen

IntechOpen