

# We are IntechOpen, the world's leading publisher of Open Access books Built by scientists, for scientists

5,400

Open access books available

133,000

International authors and editors

165M

Downloads

Our authors are among the

154

Countries delivered to

TOP 1%

most cited scientists

12.2%

Contributors from top 500 universities



WEB OF SCIENCE™

Selection of our books indexed in the Book Citation Index  
in Web of Science™ Core Collection (BKCI)

Interested in publishing with us?  
Contact [book.department@intechopen.com](mailto:book.department@intechopen.com)

Numbers displayed above are based on latest data collected.  
For more information visit [www.intechopen.com](http://www.intechopen.com)



# Cuff Pressure Pulse Waveforms: Their Current and Prospective Application in Biomedical Instrumentation

Milan Stork<sup>1</sup> and Jiri Jilek<sup>2</sup>

<sup>1</sup>University of West Bohemia, Plzen

<sup>2</sup>Carditech, Culver City, California

<sup>1</sup>Czech Republic

<sup>2</sup>USA

## 1. Introduction

Use of the arterial pulse in the evaluation of disease states has a long history. Examination of the arterial pulse is recorded by historians as being an essential part of ancient Chinese, Indian, and Greek medicine. Palpation of the pulse was very much a part of the “art” of medicine with a bewildering array of terminologies. The first accurate recording of the arterial pulse in man was performed by Etienne Jules Marey in the nineteenth century. Marey (Marey, 1881) developed a series of mechanical devices used to noninvasively record the radial pulse in humans for physiological and clinical studies. His device for the recording the peripheral arterial pulse, the sphygmogram, was soon taken up by leading clinicians of the day, who considered the contours of the arterial pulse waveform to be important for diagnosing clinical hypertension. Interest developed in detecting the onset of hypertension in asymptomatic individuals. The principal means of doing this in the late nineteenth century was using a variety of types of sphygmographs to record the arterial pulse in a wide range of asymptomatic individuals. For the first time in history, the range of contours of the human arterial pulse was recorded and interpreted.

In 1886, Marey placed the forearm and hand in a water-filled chamber to which a variable counter-pressure was applied. The counter-pressure for maximum pulse wave amplitude detected in the chamber determined that the vessel walls were maximally relieved of tension at that counter-pressure. When counter pressure was increased or decreased, the amplitudes of pulsations in the chamber decreased. This process was called *vascular unloading*.

In the early twentieth century the Italian physician Riva-Rocci invented the cuff sphygmograph (Riva-Rocci, 1896). Riva-Rocci used palpation to determine the systolic pressure. The cuff sphygmograph was later improved by the use of Korotkoff sounds that were discovered by Korotkov (Korotkov, 1956). The use of Korotkoff sounds made the sphygmomanometer much simpler to use and allowed the clinician to base diagnosis and treatment on just two numbers, the systolic and diastolic pressures, rather than requiring the rigors of arterial waveform interpretation. The cuff sphygmomanometer was rapidly introduced into clinical practice and replaced the sphygmogram as part of the evaluation of

hypertension. The reliance on the maximum and minimum values of arterial pressure, with the abandonment of interpretation within these two limits, occurred just at the time when interpretation of electrocardiographic waveforms as an important part of clinical assessment was increasing in popularity. The application of arterial pressure wave to clinical hypertension languished until the 1980s. Recordings of the ascending aortic pressure wave in individuals of varying ages and levels of blood pressures were made by Murgo in 1980 (Murgo et al, 1980) and Takazawa in 1986 (Takazawa, 1987). Such studies have led to a reawakening of interest in pressure wave contour analysis in essential hypertension. Until this recent reemergence of interest in waveform contours, pressure data obtained invasively was still largely interpreted in terms of the systolic and diastolic pressures between which the pressure wave fluctuated. There have, however, been some instances where the pressure wave contour has been utilized in the clinical evaluation. In the Framingham Study, plethysmographic volume waveforms were recorded noninvasively, using a cuff placed around the finger. In this study in over 1,000 individuals, the investigators focused their attention on the descending part of the waveform. They showed that with increasing age there was a decreasing prevalence of the diastolic wave with a less clearly defined dicrotic notch than in young individuals. In addition to an age relationship, the investigators also noted a correlation between waveform contour and the clinical incidence of coronary heart disease.

In the late twentieth century, a noninvasive method called *applanation tonometry* (Kelly et al, 1989) was used by increasing number of researchers interested in pressure waveform contours. The method uses a pencil-shaped tonometer to obtain pressure waveforms. Skilled application of the tonometer is required to obtain correct waveforms. Most published studies have used waveforms obtained from the radial artery at the wrist. By mathematical manipulation of the waveforms, it was possible to obtain an approximation of the aortic pressure (Cameron et al, 1998). O'Rourke found alterations in the tonometric waveforms with age similar to the findings of the Framingham Study.

Pulsations in the blood pressure cuff were first observed by Riva-Rocci. He called them *oscillations*. They were much later used to develop a simple, noninvasive method for the determination of blood pressures. Vascular unloading first noted by Marey became the basis for the *oscillometric* method of automatic blood pressure determination. Posey and Geddes showed in 1969 (Posey & Geddes, 1969) that the maximum amplitude of cuff pulse waveforms corresponded to true mean arterial pressure (MAP). When pressure in the cuff was increased above MAP and then decreased below MAP, the waveform amplitudes decreased. Cuff pressure (CP) and wrist cuff waveforms (WW) acquired during a gradual CP deflation procedure are shown in Fig. 1. The waveforms appear at the beginning of the procedure and reach maximum amplitude at the point of MAP. From MAP to the end of the procedure the WW amplitudes decrease.

Electronic oscillometric instruments capable of determining the systolic (SBP), mean (MAP), and diastolic arterial pressure (DBP) started appearing on the market in the 1970s. Microprocessors facilitated algorithmic methods for the determination of SBP and DBP. One of the first descriptions of a microprocessor-based device appeared in 1978 (Looney, 1978) and many more automatic BP devices have been introduced since. The exact nature of their algorithmic methods is mostly unknown because the algorithms are considered proprietary and are kept secret. The few published algorithms are based on processing the amplitudes rather than contours of the cuff pressure pulsations. One could speculate that the misleading term *oscillations* caused the lack of attention to their contours. The term oscillations first used

by Riva-Rocci appears to have been accepted without much investigation into the true nature of cuff pulsations.

Periodic waveforms usually generated by an oscillator are normally called oscillations. Pulsations generated by a beating heart are not oscillations. The terms arterial waveforms and pulse waveforms are standard terms used when contours of arterial pulsations along the arterial tree are described. Arterial waveforms acquired by several noninvasive methods have been accepted into the family of hemodynamic waveforms. The above mentioned finger cuff, finger plethysmograph, and aplanation tonometer waveforms have been analyzed more comprehensively than brachial or wrist cuff waveforms.

In the course of past several years we studied cuff pulse waveforms and noticed that under certain conditions they are similar to arterial waveforms acquired by other methods. With the aid of specially designed experimental data acquisition and processing systems we were able to gain more understanding of the cuff pressure pulse waveforms.

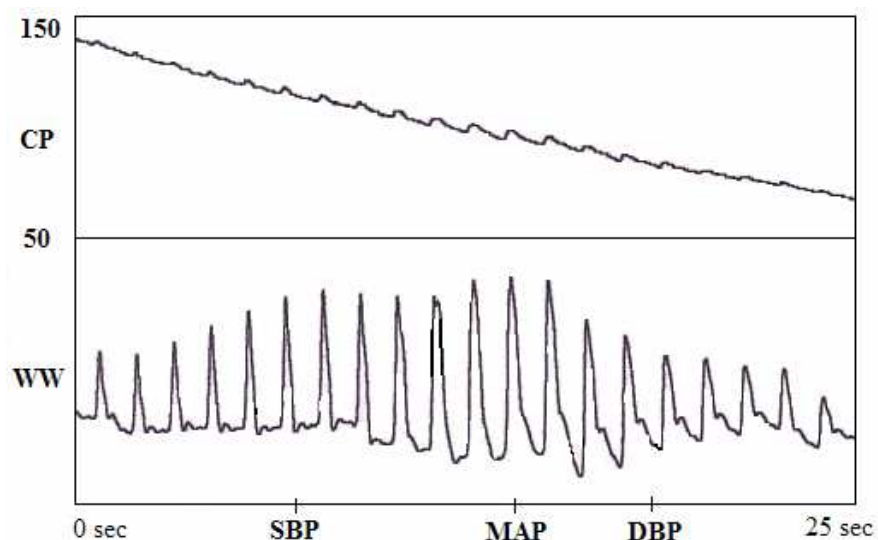

Fig. 1. Cuff pressure (CP) and wrist waveforms (WW) derived from CP. Systolic blood pressure (SBP) and diastolic pressure (DBP) reference points were determined by auscultation.

## 2. Description of the data acquisition and processing systems

The original wrist cuff system (Jilek & Stork, 2003) was conceived ten years ago. The system consists of a compact, battery powered module, a wrist cuff, and a notebook computer. Fully automatic operation of the system is controlled by the computer and a test takes less than one minute. Block diagram of the module and the cuff is in Fig. 2. The module's microcontroller (Intel 87C51) communicates with the notebook via serial interface (USB). The notebook controls inflation and deflation of the cuff and acquisition of data. Operation of the system starts with cuff inflation to about 30 mmHg above expected SBP. Cuff pressure is converted to analog voltage by pressure sensor (piezoresistive bridge type, range 0-250 mmHg). The analog voltage is amplified by an instrumentation amplifier (Burr-Brown INA118) and filtered by a low-pass filter with cutoff frequency of 35 Hz. The pressure voltage is digitized by a 12-bit A/D converter with serial output (MAX1247). The A/D converter operation is controlled by the microcontroller.

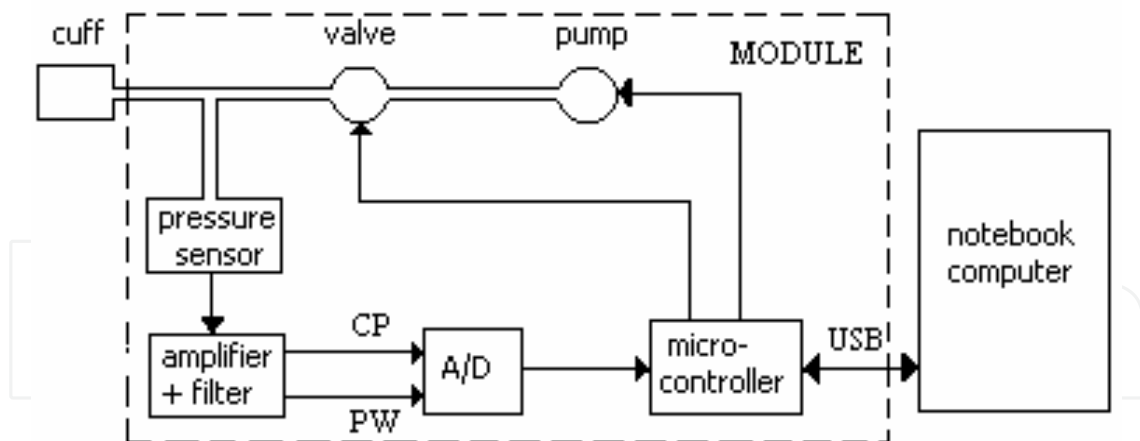

Fig. 2. Block diagram of single cuff system for acquisition and processing of wrist cuff waveforms.

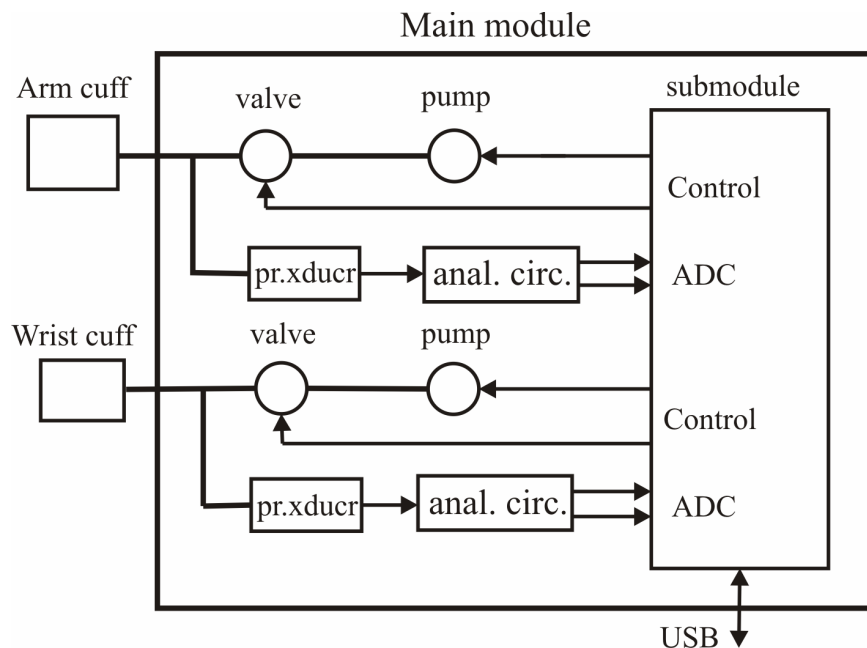

Fig. 3. Block diagram of the dual cuff system.

Sampling rate is 85 samples per second. The digitized samples are sent to the notebook at 11.6 ms intervals. The deflation of the cuff is controlled by a current controlled air-flow valve (Omron 608). Deflation rate is controlled by notebook software.

When cuff pressure drops below diastolic pressure, the valve opens and the cuff is rapidly deflated. Computation of blood pressures and hemodynamics takes place next. All functions and computations are performed by special software.

The need to improve the system led to the development of dual cuff system. The system consists of a compact module with pneumatic and electronic circuits, two detachable cuffs (arm and wrist), and a notebook computer that is connected to the module via a USB cable.

Block diagram of the module with two cuffs is in Fig. 3. The two pneumatic and analog circuits for the cuffs are similar. Pumps inflate the cuffs and cuff deflation is controlled by the valves. Piezoelectric pressure transducers (pr.xducer) provide analog signal that is

amplified, filtered, and separated into two channels. One channel provides cuff pressure and the other channel provides amplified cuff-pressure waveforms. The analog circuits are close approximation of the single cuff system's circuit. The resulting analog signals are digitized in the *submodule*. Analog-to-digital conversion is 12-bit, 85 conversions/ sec operation. The digitized data are converted into USB format and made available to the notebook. The notebook contains special software that controls the module's functions and receives four channels of digitized data. We designed the specialized software as Windows-based multifunction system that performs the following functions:

- **Dual-cuff test** - uses both the upper-arm and wrist cuffs. The arm cuff is used to acquire brachial cuff pressure pulses and the wrist cuff is used in a manner similar to a stethoscope; appearance of wrist-cuff pulses indicates SBP. SBP, MAP and DBP values are also determined by a commonly used ratiometric method from the arm cuff pulses.
- **Wrist-cuff test** - uses only wrist cuff pulses in a manner similar to the single cuff system. Blood pressures and hemodynamics are determined from wrist waveforms and body area.
- **Show waveforms** - shows waveforms from both cuffs (dual-cuff system) or only from wrist cuff. Each individual sample can be examined visually and numerically.
- **Show Quadrant** (wrist-cuff test only) - shows hemodynamics numerically and graphically (see Fig. 12 and Fig. 13).
- **Store test** - stores all raw data and subject name in a numbered file.
- **Get test** - gets raw data from disc file and performs computations.
- **Variables** - shows important computed variables.
- **Test directory** - shows test (file) numbers and subject names.

### 3. Characteristics of the cuff-pulse waveforms

Waveforms acquired from blood pressure cuffs exhibit characteristics that are similar to, but not the same as arterial waveforms acquired by other methods. Even waveforms acquired simultaneously, but from different anatomical sites are not identical. The brachial cuff and wrist cuff waveforms in Fig. 4 illustrate this assertion. The top trace shows the wrist waveforms (WW) and the bottom trace shows arm (brachial) waveforms (AW) acquired simultaneously with the dual cuff system from an adult volunteer in the sitting position. The waveforms were acquired at the cuff pressure (CP) just below the point of DBP. The wrist waveforms have more sharply defined contours when compared with the brachial waveforms. The dicrotic notches on the descending part of the waveforms are well defined on the wrist waveforms. The brachial waveforms are more rounded and the dicrotic notches are barely visible. We believe that larger volume of air in the brachial cuff and larger amount of soft tissue on the upper arm cause the substantial damping of brachial cuff waveforms. Smaller volume of air and relatively low amount of soft tissue make the wrist cuff waveforms better suited for waveform analysis. It is important to acquire the waveforms at CP lower than the point of DBP. The waveforms shown in Fig 5 illustrate the need for appropriate cuff pressure. The waveforms were acquired during a gradual cuff deflation as is done during automatic BP measurement.

The waveforms at cuff pressures above DBP are distorted because the radial artery is fully or partially occluded by the wrist cuff and blood flow under the cuff is turbulent. Turbulent blood flow is the source of Korotkoff sounds that are used in manual BP determination. When CP is lowered to pressures equal to or below DBP, the artery is no longer occluded, the waveforms are not distorted and Korotkoff sounds are no longer heard.



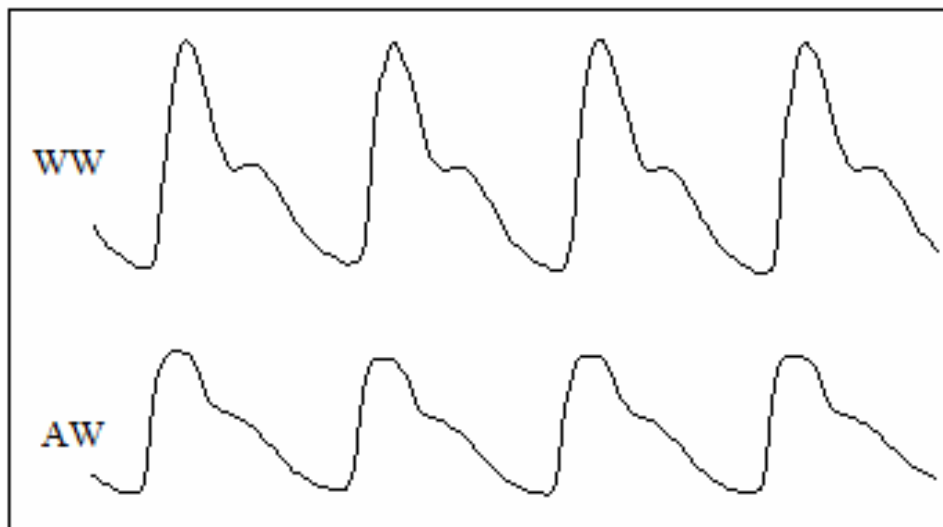

Fig. 4. Wrist waveforms (WW) and arm waveforms (AW) were acquired simultaneously.

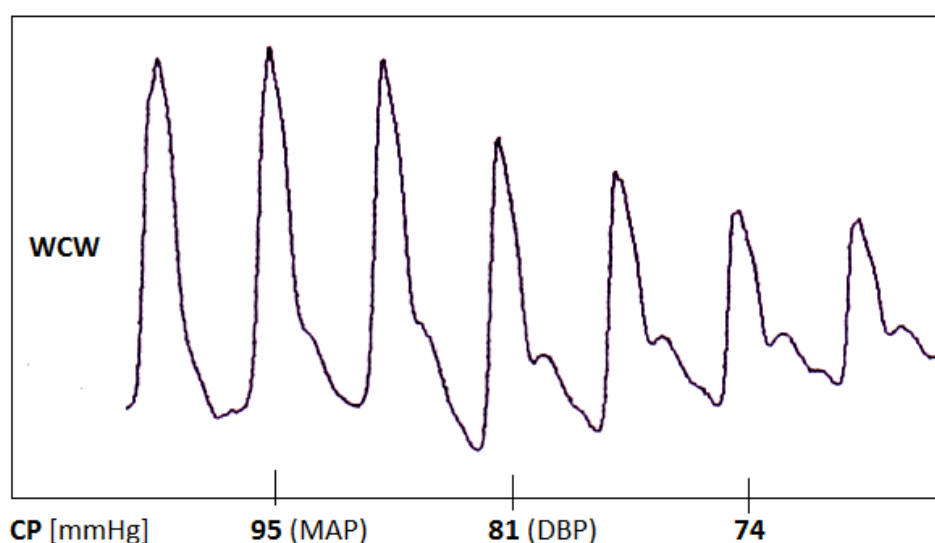

Fig. 5. Wrist cuff (WCW) waveforms acquired during a gradual cuff deflation. Cuff pressure decreases from left to right. The DBP reference point of 81 mmHg was determined by the manual method.

Wrist cuff waveforms acquired at DBP or lower CP are similar to waveforms obtained by other noninvasive methods. Fig. 6 shows wrist cuff waveforms (WCW) and finger photoplethysmograph (PPG) waveforms acquired simultaneously. Another example of noninvasive waveforms is in Fig. 7. The waveforms were acquired by applanation tonometry from the radial artery (wrist).

The waveforms shown in Fig. 6 and 7 are not identical but their contours are similar and they share some important characteristics. The important arterial waveform segments are rapid systolic upstroke, late-systolic downturn, dicrotic wave, and diastolic segment. Rapid systolic upstroke lasts approximately from the onset to the peak of the waveform. Late-systolic downturn lasts approximately from the peak to the dicrotic wave. Diastolic segment lasts from the dicrotic wave to the onset of the next systolic upstroke.

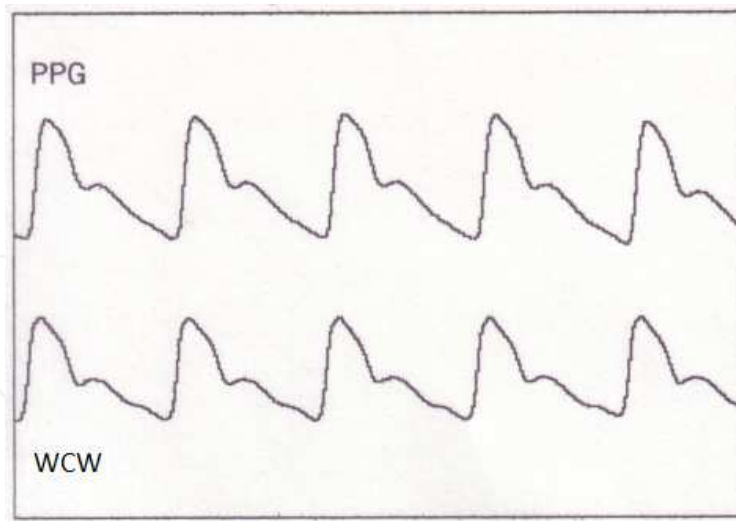

Fig. 6. Wrist cuff (WCW) and photoplethysmographic (PPG) waveforms were acquired simultaneously.

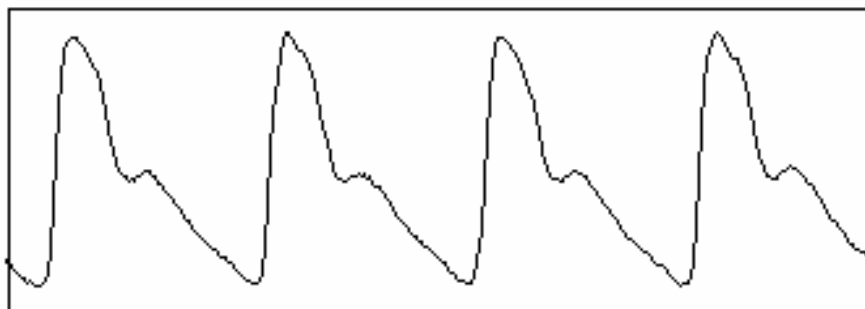

Fig. 7. Radial (wrist) waveforms acquired from the wrist by applanation tonometry.

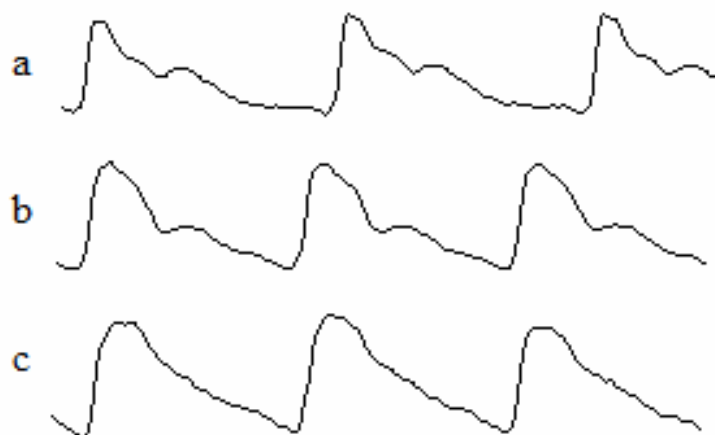

Fig. 8. Wrist cuff waveforms reflecting age differences.

Systolic upstroke, late-systolic downturn, diastolic wave, and diastolic segment can be easily identified on all of the waveforms in Fig. 6-7. The waveforms are not, however, identical.



The reasons for differences in contour shapes are numerous and they include location on the arterial tree, arterial compliance, wave reflections, and subject's age. Age differences can be observed on the wrist cuff waveforms in Fig. 8. Waveforms from a young subject (a) have steeper systolic upstroke and more pronounced dicrotic wave than those of middle age (b) and elderly (c) subjects. Similar age-related changes were observed in tonometric radial waveform contours (Kelly et al, 1998).

The comparisons of wrist cuff waveforms with waveforms acquired by other methods led us to the conviction that the cuff waveforms are suitable for applications beyond blood pressure measurement.

#### **4. Current and new methods using cuff pressure waveforms**

Cuff pressure waveforms have been used almost exclusively in automatic BP monitors, where their amplitudes are the basis for algorithmic computations of SBP, MAP, DBP, and heart rate (HR). Cuff pressure waveform contours have been largely ignored.

##### **4.1 Current automatic blood pressure measurement**

Automatic oscillometric BP monitors are the dominant types of noninvasive BP devices. There are many models on the market, ranging from professional monitors used in health care facilities to inexpensive monitors used in homes. Most home monitors are the upper-arm (brachial) type, but wrist monitors are gaining popularity. Finger cuff monitors are not recommended by professionals because of the accuracy issues. The main advantage of oscillometric BP monitors is their ease of use. Only the cuff must be applied to the appropriate physiological site. A typical automatic oscillometric device uses an air pump to inflate the cuff and cuff pressure is then slowly decreased. A pressure transducer is used to convert the cuff pressure into electronic signal. The signal is then amplified, filtered and the cuff pulsations are separated from the cuff pressure. The resulting cuff pulsation waveforms (see Fig. 1) are then used to algorithmically determine the pressures. Published algorithmic methods for the determination of SBP and DBP present differing approaches. Geddes makes certain empirical assumptions about algorithmic determination. His proposed algorithm is based on the ratio of waveform amplitudes. According to Geddes (Geddes, 1982), SBP corresponds to the point of 50% of maximum amplitude (MAP); for DBP, the ratio is 80%. Another proposed ratio algorithm (Sapinsky, 1992) uses the point of SBP at 40% of maximum amplitude and 75% of max. amplitude for DBP. Other algorithms for the determination of blood pressure are based on the change of slope in the waveform amplitude envelope. An article describing the function of an oscillometric BP device (Borow, 1982) claims that the device determines SBP as the point of the initial increase of the cuff pulsations. Another author (Ng, 1999) puts SBP on the minimal ascending slope of the amplitude envelope and DBP on the maximum slope of the descending envelope. The above algorithmic approaches result in differing SBP and DBP values. Furthermore, the approaches do not offer physiological explanation for their assertions. The only commonly recognized and physiologically verified variable is the MAP. Common to the published algorithms is that they use amplitudes of cuff pulsations. Little attention has been paid to the contours of these pulsations. Algorithms used in commercial monitors are generally considered intellectual property and are kept secret. This makes verification of accuracy difficult. There are several test instruments on the market, but they can perform only static tests, such as static pressure accuracy, leakage test, cuff deflation test, and overpressure test.

They cannot, however, perform dynamic algorithmic accuracy tests. No regulatory agency has put forth a standard as to how oscillometric pulse amplitudes should be interpreted to determine BP values. Because there are no reliable instruments for testing the dynamic accuracy of BP monitors, performance testing protocols for device validations have been developed. The Association for the Advancement of Medical Instrumentation, the British Hypertension Society, and the European Society of Hypertension recommend validation of NIBP devices against auscultation or against intra-arterial methods. Validation studies require recruitment of large number of volunteers with varied blood pressures, ages, and arm circumferences. These requirements inevitably make validation studies expensive.

Many validation studies have been conducted and some reviews of validation results have been published. Their findings indicate that the accuracy of BP determination is problematic for many NIBP devices. Validation protocols are not without problems either. A recently published study (Gerin et al, 2002) exposed limitations of current validation protocols. The study concludes that the existing protocols are likely to pass devices that can be systematically inaccurate for some patients. Disappointing validation results, lack of information from device manufacturers and errors observed in healthcare institutions have led to warnings issued by experts in the field of BP measurements. The American Heart Association issued an advisory statement from the Council for High Blood Pressure Research (Jones et al, 2001). The Council cautioned healthcare professionals not to abandon mercury sphygmomanometers until adequate replacement instruments are available. A recent report by a group of leading experts (Jones et al, 2003) stressed the importance of accurate BP measurements. The report called for additional research to assess accuracy of NIBP devices and concluded that mercury sphygmomanometer remains the gold standard for noninvasive BP measurement.

The above issues led us to investigations into prospective improvements of the cuff pulse based BP measurement and into applications reaching beyond BP measurement.

#### **4.2 Database of physiological cuff pressure waveforms**

Cuff pressure BP waveforms are indispensable for noninvasive determination of BPs and they may contain other useful information. An investigator or a device developer who wants to study cuff pressure waveforms needs a reasonably large database of waveforms and reference blood pressure measurements. Manufacturers of oscillometric BP devices must have such databases in order to conduct their development efficiently. These databases are, however, proprietary. There are no publicly accessible databases of cuff waveforms at the present time. On the other hand, public databases for some physiologic waveforms do exist, mainly for interpretation of electrocardiograms. General principles of acquisition and use of physiological waveforms are described in the Association for the Advancement of Medical Instrumentation Technical Information Report (AAMI, 1999). The report stresses the necessity to test algorithmic functions of digital devices with real physiologic data. Properly documented databases are needed for such testing. The waveforms can then be used to test devices repeatedly and reproducibly. A wide-ranging, publicly available database of oscillometric BP waveforms could advance the field of oscillometric BP measurement in the following ways:

- New research into the largely unknown physiological basis of oscillometric BP measurement. The research could result in the development of a generic algorithmic method for the determination of SBP and DBP.

- Device developers would enjoy the advantage of not having to develop their own proprietary databases, as the past and present manufacturers had to do. Costs of development and time to market could be decreased. A standardized, public database would serve as a common knowledge base and it should produce devices performing in a similar, predictable manner.
- Repeatable, reproducible performance testing of oscillometric BP devices could become possible. The expensive, time consuming testing as performed today could eventually be eliminated.
- Determination of hemodynamic variables. It may be possible to derive cardiac output (CO), total peripheral resistance, and arterial compliance from cuff pulse waveform contours and blood pressures. Several contour methods for CO determination already exist.

A specialized data acquisition system such as the dual cuff system we have developed could be used to build a database of cuff pressure waveforms.

	SBP [mmHg]	DBP [mmHg]
<b>Reference BP</b>	122	78
<b>Geddes method</b>	135	88
<b>Sapinsky method</b>	144	81

Table 1. Results of 2 algorithmic methods applied to data acquired for this study

The acquired cuff pulse and reference BP data can be used to test algorithms for BP determination (Jilek & Stork, 2005). The data acquired for this study were applied to 2 published algorithms. According to Geddes and Sapinsky, SBP and DBP can be determined as fixed ratios of OMW amplitudes. Geddes specifies 50 % of maximal OMW amplitude as the point of SBP; for DBP, the ratio is 80 %. Sapinsky specifies the ratio for SBP as 40 % of maximal OMW amplitude; for DBP the ratio is 55%. The results are shown in Table 1. Different SBP and DBP values obtained by reference measurement by auscultation and by the algorithmic methods are indicative of problems that exist in the field of oscillometric BP measurement.

Another important prospective database application is performance testing of oscillometric BP monitors. There are several commercial testing instruments on the market but they can perform only static tests of pressure sensors and amplifiers. Proper dynamic BP accuracy testing can be performed only by applying real physiological waveforms. Monitors equipped with suitable interfaces could be tested for dynamic accuracy. Such monitors do not exist today but in the future the interfaces could be incorporated reasonably easily. A BP monitor test system could be implemented with a notebook computer, a USB interface, a special software for CP and cuff pulse waveform processing, and the database stored on a CD-ROM. Monitor testing could be performed quickly and reproducibly.

The concept of a database of physiological cuff waveforms has two major advantages over currently used validations of automatic BP monitors: (1) the database needs to be developed only once and it can then be used quickly and repeatedly to test BP algorithms and to develop new ones; (2) automatic BP monitors could be equipped with interfaces allowing database waveforms to bench-test performance of monitors. Such testing is not presently possible. Expensive, time consuming monitor validations as performed today could be eventually eliminated.

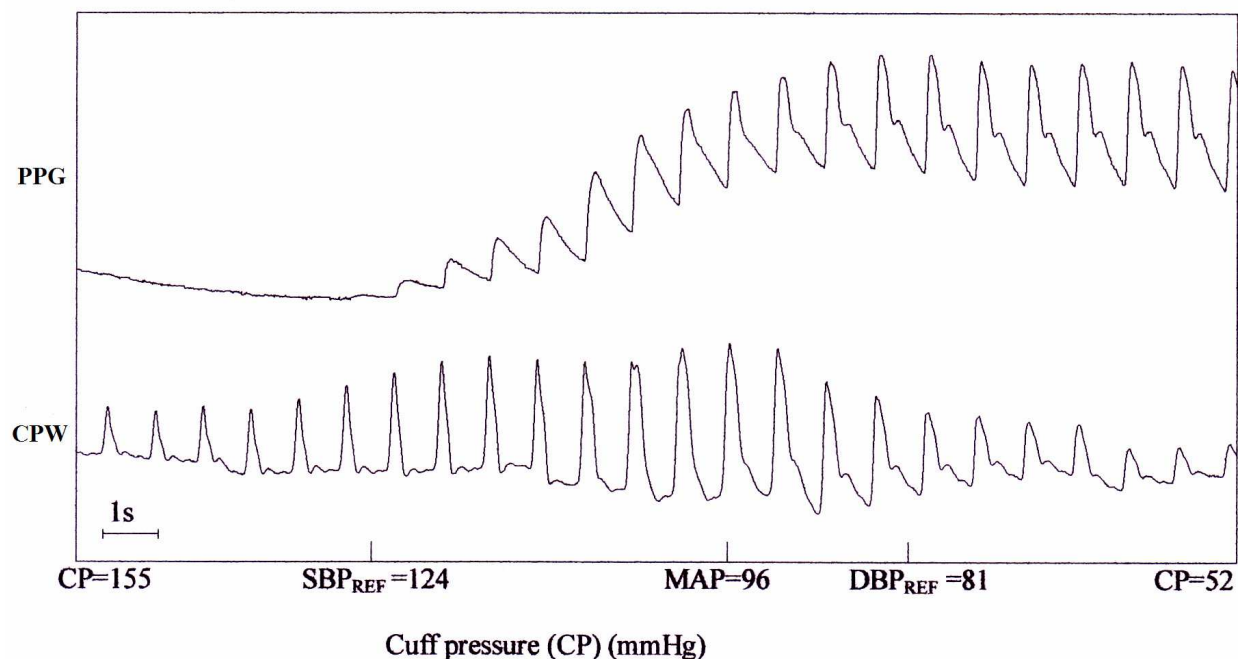

Fig. 9. Cuff pressure waveforms (CPW) and photoplethysmographic (PPG) waveforms were acquired simultaneously. Reference points  $SBP_{REF}$  and  $DBP_{REF}$  were determined manually.

#### 4.3 Automatic BP determination based on physiological principles

A gradual wrist cuff deflation procedure was divided into four segments (Jilek & Fukushima, 2007). The following section contains description of CPW and PPG amplitude and shape changes and explanation of each phase in terms of vascular unloading and blood flow. The phases of Korotkoff sounds are mentioned where appropriate.

The first segment lasts from cuff pressure approximately 30 mmHg above  $SBP_{REF}$  to  $SBP_{REF}$  (Fig. 9). Cuff pressure waveforms (CPWs) are present because arterial pulsations are transmitted to the upper edge of the cuff. The CPW amplitudes increase according to vascular unloading as cuff pressure is deflated toward  $SBP_{REF}$ . No blood flows past the cuff and no Korotkoff sounds are heard. The PPG trace is flat because no flow signal passes past the cuff. The second segment lasts from  $SBP_{REF}$  to MAP. Turbulent blood flow starts passing under the cuff into the distal vasculature. The vasculature initially exhibits low resistance (R) to the flow (Q). The low R lowers the pressure (P) according to

$$P = Q * R \quad [\text{mmHg, ml/min, mmHg}] \quad (1)$$

Low P counteracts vascular unloading and the slope of CPW amplitude envelope is decreased. As flow starts passing past the cuff, volume and pressure in the distal vasculature increase and PPG waveforms appear. As more flow passes past the cuff, volume and pressure in the distal vasculature increases due to blocked venous return. The PPG reflects this by rising baseline and amplitude increase. When CP and arterial wall pressures are equal, the CPWs reach maximal amplitudes. The CP at this point is equal to MAP according to vascular unloading. The CPW shapes are distorted because of the continuing partial occlusion of the artery. The flow is still turbulent and Phase II Korotkoff sounds are heard. The third segment lasts from MAP to  $DBP_{REF}$ . The CPW amplitudes start decreasing with cuff pressure deflation according to vascular unloading. Continuing blood outflow into



the vasculature enhances the rate of amplitude decreases. The CPW shapes continue to be distorted because the artery is still partially occluded. Blood flow under the cuff is still turbulent, but the blood flow velocity is decreased and Korotkoff sounds are muffled (Phase 4). When cuff pressure reaches  $DBP_{REF}$ , the flow becomes laminar and the Korotkoff sounds are no longer heard (Phase V). The artery under the cuff is free from partial occlusion and the CPWs are no longer distorted.

The fourth segment lasts from  $DBP_{REF}$  to the end of procedure. When cuff pressure is further deflated below  $DBP_{REF}$ , the artery under the cuff is free from partial occlusion, blood flow is laminar and CPWs are not distorted. Korotkoff sounds are not heard. Further cuff pressure lowering decreases CPW amplitudes according to vascular unloading. At some arbitrary cuff pressure below  $DBP_{REF}$ , the cuff is quickly deflated and the cuff deflation procedure is terminated.

Observations of the effects of blood flow under the cuff and in the hand on the CPW amplitude envelope resulted in the following hypothesis: The slope of CPW waveform amplitude envelope at cuff pressures higher than the reference systolic pressure and the slope at cuff pressures between mean pressure and reference diastolic pressure are steeper than the slope between reference systolic pressure and mean pressure. Based on the above observations we conducted a study of 32 volunteers (Jilek & Fukushima, 2007). To test the hypothesis, 3 slopes (S1-S3) on the waveform amplitude envelope were computed and compared. S1 is the slope from cuff pressure 30 mm higher than reference systolic pressure to the cuff pressure equal to the reference systolic pressure. S2 is the slope from cuff pressure equal to the reference systolic pressure to the cuff pressure equal to mean pressure. S3 is the slope from cuff pressure equal to mean pressure to cuff pressure equal to reference diastolic pressure.

$$S1 = (WA_{HSBP} - WA_{SBP}) / (CP_{HSBP} - CP_{SBP}) \quad (2)$$

$$S2 = (WA_{SBP} - WA_{MAP}) / (CP_{SBP} - CP_{MAP}) \quad (3)$$

$$S3 = (WA_{MAP} - WA_{DBP}) / (CP_{MAP} - CP_{DBP}) \quad (4)$$

$WA_{HSBP}$  is the wave amplitude at cuff pressure about 30 mmHg higher ( $CP_{HSBP}$ ) than cuff pressure at reference systolic pressure.  $WA_{SBP}$  is the wave amplitude at cuff pressure equal to the reference systolic pressure ( $CP_{SBP}$ ).  $WA_{MAP}$  is the wave amplitude at cuff pressure equal to the computed mean pressure ( $CP_{MAP}$ ).  $WA_{DBP}$  is the wave amplitude at cuff pressure equal to the reference diastolic pressure ( $CP_{DBP}$ ).

The tabulated mean values are shown in Table 2. The slopes S1, S2 and S3 were computed according to the formulas (1-3).

N=32	SBP	MAP	DBP	S1	S2	S3
<b>Mean</b>	132	102	85	-0.065	-0.025	0.114
<b>SD</b>	17	13	12	0.022	0.012	0.035

Table 2. Mean values of SBP, MAP, DBP, and amplitude envelope slopes S1, S2, and S3 of 32 volunteers.

Our observations and the experimental results supported the central hypothesis. All the S1 and S3 slopes were steeper than the S2 slopes. The inter-subject variability suggests that the

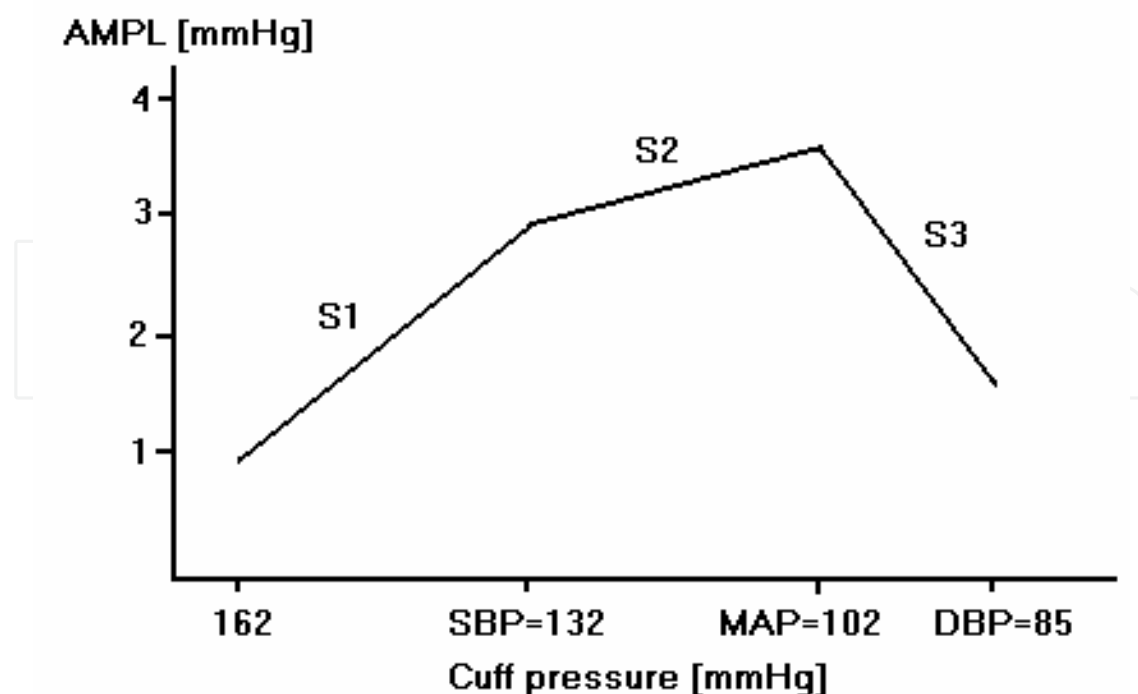

Fig. 10. Graphic representation of the amplitude envelope slopes S1, S2 and S3. AMPL (vertical axis) are mean values of waveform amplitudes.

slopes are affected by a number of variables. Arterial compliance, mean pressure, heart rate, stroke volume, and blood viscosity have been cited as factors affecting the slopes. These factors do not change substantially during a single gradual cuff deflation. Our study suggested that the blood flow under the cuff and in the hand is an important physiological variable decreasing S2 during a gradual cuff deflation procedure.

Graphic representation of amplitude envelope constructed from the mean values in Table 1 is in Fig. 10. Transition point from S1 to S2 in the vicinity of SBP has implications for a prospective development of a new type of algorithmic method based on physiology. A method capable of detecting the transition from S1 to S2 could improve the accuracy of SBP determination. High level of accuracy may be, however, difficult to achieve with manipulation of the cuff pressure pulse amplitudes. The slopes are not very steep and they may be difficult to determine without reference BP values. Furthermore, cuff waveform amplitudes are affected by a number of factors, such as movement artifacts, arrhythmias, tremors and deep breathing. Arrhythmias present especially difficult problems because their nature and frequency of occurrence are not always apparent.

#### 4.4 Dual cuff method for the determination of systolic blood pressure

Cuff pressure waveform amplitude methods have been widely used in electronic BP monitors, but their accuracy has been questioned. The manual method using a sphygmomanometer and a stethoscope is still the gold standard of noninvasive BP determination. Improvement in automatic noninvasive methodology is desirable.

We previously studied the use of a finger photoplethysmographic (PPG) waveforms for improved determination of the SBP (Jilek & Stork, 2004). As illustrated in Fig. 9, the cuff waveforms appear at cuff pressures well above the SBP. This is in contrast to the auscultatory method. At CPs higher than SBP no sounds are heard. When CP drops to



below SBP the Korotkoff sounds can be heard. Similarly, the PPG waveforms appear just below the level of SBP. Observation of the waveforms in Fig. 9 makes it obvious that it is easier to detect SBP with PPG signal than with just the cuff pressure waveforms. The PPG method has, however, some shortcomings. A PPG transducer must be attached to a finger and adjusted to detect usable waveforms. When the patient's fingers are cold, it becomes difficult to obtain usable waveforms.

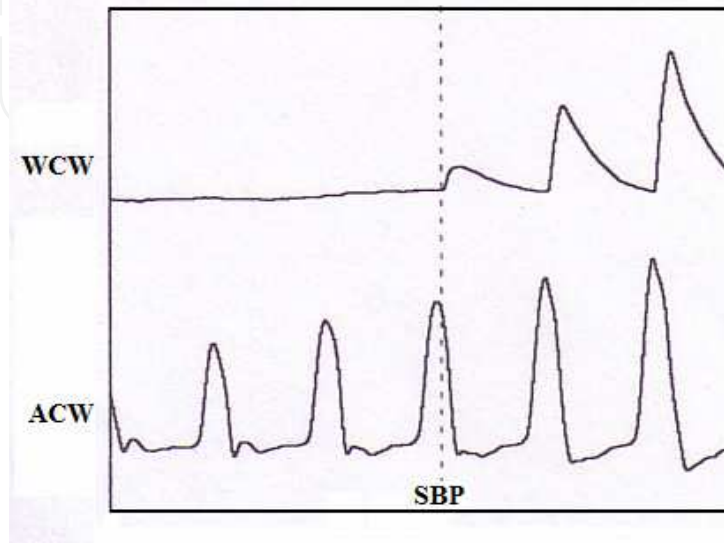

Fig. 11. Wrist cuff waveforms (WCW) and arm cuff waveforms (ACW) obtained simultaneously. Systolic pressure (SBP) is the point of WCW appearance.

A better method is the use of two cuffs. We used the dual cuff system to study the method. The arm cuff is used for the determination of MAP and DBP, and the wrist cuff is used to detect pulsations that appear at CPs lower than SBP. Waveforms acquired during dual-cuff test are shown in Fig. 11. The upper trace shows waveforms from the wrist cuff (WCW) and the lower trace shows waveforms from the arm cuff (ACW). The appearance of WCW indicates SBP. In the test shown in Fig. 11 the SBP measured by WCW appearance was 174 mmHg and the SBP determined by amplitude ratio method was 159 mmHg. The amplitude ratio method erroneously determined the SBP because of uneven slope S1.

#### 4.5 Determination of hemodynamics from cuff pressures and waveforms

As shown in section 3, cuff pressure waveforms obtained at CPs at or below DBP level exhibit properties similar to arterial waveforms obtained by other methods. We have previously investigated the use of wrist cuff pressures and waveforms for the determination of hemodynamics (Jilek & Stork, 2003). The waveforms are used principally to compute stroke volume (SV). Since the SV is not obtained by estimating the actual left ventricular volume, the SV computed from the radial artery must be adjusted for body surface area (BSA) (formula 5).

$$BSA = (\text{weight} + \text{height} - 60) / 100 \quad [\text{m}^2, \text{kg}, \text{cm}] \quad (5)$$

Cardiac output is then computed by multiplying stroke volume by heart rate:

$$CO = SV * HR \quad [\text{L}/\text{min}, \text{mL}, \text{bpm}] \quad (6)$$

Total peripheral resistance (TPR) is obtained by dividing mean arterial pressure by cardiac output:

$$\text{TPR} = 80 * \text{MAP} / \text{CO} \quad [\text{dyn, mmHg, L/min}] \quad (7)$$

Systemic arterial compliance (SAC) is computed according to the formula (8), where

$$\text{SAC} = \text{SV} / \text{PP} = \text{SV} / (\text{SBP} - \text{DBP}) \quad [\text{mL, mL, mmHg}] \quad (8)$$

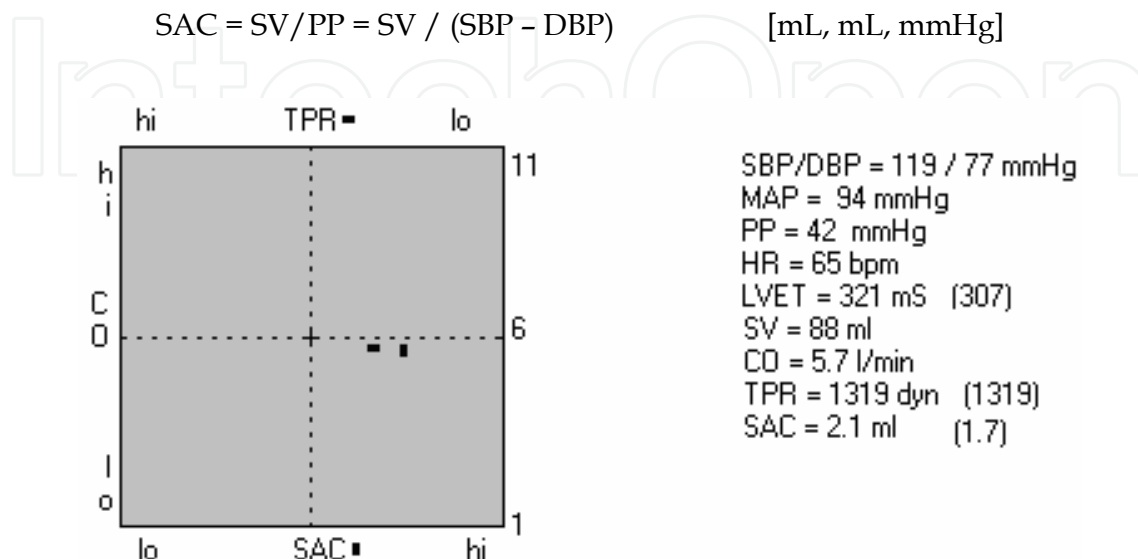

Fig. 12. Graphic and numeric results of a “normal” test.

This measure of compliance was used because both of the variables used (SV, PP) are already available. Moreover, pulse pressure is recognized as surrogate measure of arterial compliance. The computed blood pressure and hemodynamic variables are displayed on the computer screen as numeric values and as a “quadrant” graphic format (Fig. 12). The quadrant shows the relationships of cardiac output (CO), total peripheral resistance (TPR), and systemic arterial compliance (SAC). TPR and SAC are graphically represented by small rectangles and they move together on the vertical (CO) axis according to the value of CO. TPR and SAC rectangles are positioned on the horizontal axis according to their values. Higher SAC and lower TPR values move the rectangles to the right. Normal values of TPR and SAC are displayed graphically in the right half of the quadrant. Abnormal values (usually accompanied by hypertension) are located in the left half.

The values displayed in Fig. 12 are typical values of a normotensive, middle-age male. TPR and SAC values are graphically represented in the right “good” half of the quadrant.

Fig. 13. shows hemodynamic values corresponding to chronic hypertension in an elderly woman. Blood pressures are elevated, cardiac output is within normal range and total peripheral resistance (TPR) is high. Systemic arterial compliance (SAC) is substantially reduced. Both TPR and SAC are graphically represented in the left “bad” half of the quadrant.

Data from the system’s developmental database were used to compute and compare hemodynamic values estimated by the system with values obtained from a study conducted by De Simone et al (De Simone et al, 1997). Our data from a group of 41 male and female volunteers (age 17 -76) were computed. The comparative values are displayed in table 3. This informal comparison shows good agreement between our HR, SV, CO values and the values obtained by De Simone.

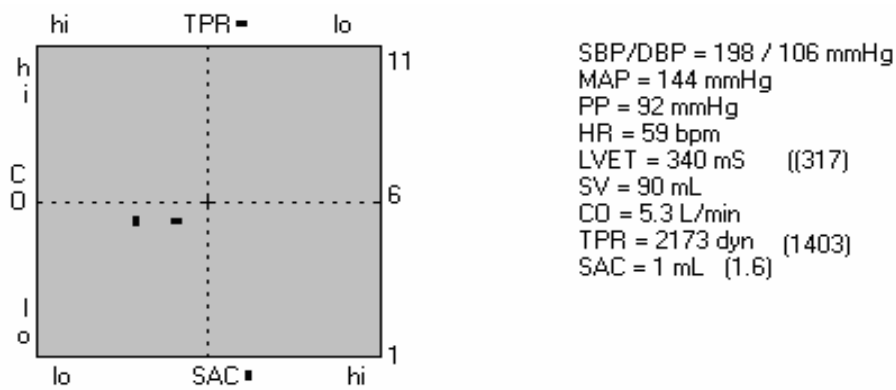

Fig. 13. Test results of a hypertensive woman.

	HR [bpm]	SV [ml]	CO [l/min]
<b>System (n=41)</b>	70	76	5.3
<b>De Simone (n=544)</b>	68	81	5.5

Table 3. Comparison of hemodynamic variables

## 5. Conclusion and future work

Our preliminary investigation into the nature of cuff pressure waveforms resulted in promising future possibilities for their practical applications:

- A comprehensive database of cuff pulse waveforms and reference BP values could lead to improved BP determination and to improved testing of automatic BP monitors.
- Improved determination of blood pressures from slope transitions.
- A new method for improving SBP determination is the use of wrist cuff to detect the onset of blood flow past the arm cuff.
- The estimation of blood pressures and hemodynamics promises to improve the diagnosis and treatment of resistant hypertension.
- Wrist cuff waveforms may find applications as surrogates for radial tonometric waveforms.



Fig. 14. The blood pressure measuring with dual-cuff method.

It should, however, be noted that the results of our investigation are preliminary and that verification studies will have to be performed before the new methods can be applied in current clinical instrumentation. Example of dual cuff measuring is shown in Fig. 14.

## 6. References

- AAMI, (1999). Acquisition and use of physiologic waveform database for testing of medical devices, *Technical information report AAMI TIR no. 24*, Arlington, VA.
- Borow, K.M. & Newburger J.W. (1982). Noninvasive estimation of central aortic pressure using the oscillometric method for analyzing systemic artery pulsatile blood flow; comparative study of indirect systolic, diastolic and mean brachial artery pressure with simultaneous direct ascending aortic pressure measurement, *Am Heart J*, Vol. 103, pp 879-898.
- Cameron, JD. et al (1998). Use of radial artery applanation tonometry and a generalized transfer function to determine aortic pressure augmentation in subjects with treated hypertension, *J Am Coll Cardiol*, Vol. 32, pp 1214-1220.
- De Simone G., et al (1997). Stroke volume and cardiac output in normotensive children and adults. *Circulation*, Vol. 95, pp 1837-1843.
- Geddes, L.A. (1982). Characterization of the oscillometric method for measuring indirect blood pressure. *Ann Biomed Eng*, Vol. 10, pp 271-280.
- Jilek, J. & Stork, M. (2003). An experimental system for estimation of blood pressures and hemodynamics from oscillometric waveforms. *Proceedings of AE2003 International Conference*, pp 111-114, ISBN 80-7082-951-6, Pilsen, September 2003.
- Gerin, W. et al (2002). Limitations of current validation protocols for home blood pressure monitors for individual patients. *Blood Press Monit*, Vol. 7, pp 313-318.
- Jilek, J. & Stork, M. (2004). Improved noninvasive systolic blood pressure detection with finger photoplethysmograph. *Proceedings of AE2004 International Conference*, pp 91-94, ISBN 80-7043-274-8, Pilsen, September 2004.
- Jilek, J. & Stork, M. (2005). Data acquisition for a database of oscillometric blood pressure waveforms. *Proceedings of AE2005 International Conference*, pp 151-154, ISBN 80-7043-369-8, Pilsen, September 2005.
- Jilek, J. & Fukushima, T. (2007). Blood flow under wrist cuff, in hand alters oscillometric waveforms during blood pressure measurement. *Biomed Instrum Technol*, Vol. 41, pp 238-243.
- Jones, D.W. et al (2001). Mercury sphygmomanometers should not be abandoned: an advisory statement from the Council for High Blood Pressure Research, American Heart Association. *Hypertension*, Vol. 37, pp 185-186.
- Jones, D.W. et al (2003). Measuring blood pressure accurately. *JAMA*, Vol. 289, pp 1027-1030.
- Kelly, R.P. et al, (1998). Non-invasive registration of arterial pressure pulse-waveform using high-fidelity applanation tonometry. *J Vasc Med Bio*, Vol. 1, pp 142-149.1
- Korotkov, N.S. (1956). A contribution to the problem of methods for the determination of the blood pressure. In: Ruskin A, ed. *Classics of Arterial Hypertension*, Thomas, Springfield, Ill., pp 127-133.
- Looney, J. (1978). Blood pressure by oscillometry. *Med Electron*. Pp 57-63.
- Marey, E.J. (1881). *La Circulation du sang a l'état physiologique et dans les maladies*, Paris, Masson.

Murgo, J.P. et al (1980). Aortic input impedance in normal man: Relationship to pressure waveforms. *Circulation*, Vol. 62, pp 105-116.

Ng, K.G. Blood pressure measurement, *Med Electron*, Vol. 19, pp 61-64.

Posey, J.A. & Geddes, L.A. (1969). The measuring of the point of maximum oscillations in cuff pressure in the indirect measurement of blood pressure. *Cardiovasc Res Bul*, Vol. 8, pp 15-25.

Riva-Rocci, S. (1896). Un sfigmomanometro Nuovo, *Gaz Med Trino*. pp981-996.

Takazawa K. (1987). A clinical study of the second component of left ventricular systolic pressure. *J Tokyo Med Coll*. Vol. 45, pp 256-270.

IntechOpen

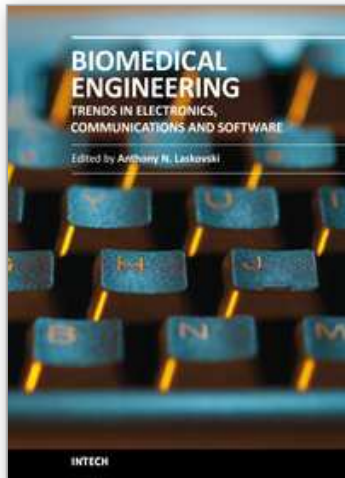

## **Biomedical Engineering, Trends in Electronics, Communications and Software**

Edited by Mr Anthony Laskovski

ISBN 978-953-307-475-7

Hard cover, 736 pages

**Publisher** InTech

**Published online** 08, January, 2011

**Published in print edition** January, 2011

Rapid technological developments in the last century have brought the field of biomedical engineering into a totally new realm. Breakthroughs in materials science, imaging, electronics and, more recently, the information age have improved our understanding of the human body. As a result, the field of biomedical engineering is thriving, with innovations that aim to improve the quality and reduce the cost of medical care. This book is the first in a series of three that will present recent trends in biomedical engineering, with a particular focus on applications in electronics and communications. More specifically: wireless monitoring, sensors, medical imaging and the management of medical information are covered, among other subjects.

### **How to reference**

In order to correctly reference this scholarly work, feel free to copy and paste the following:

Milan Stork and Jiri Jilek (2011). Cuff Pressure Pulse Waveforms: Their Current and Prospective Applications in Biomedical Instrumentation, Biomedical Engineering, Trends in Electronics, Communications and Software, Mr Anthony Laskovski (Ed.), ISBN: 978-953-307-475-7, InTech, Available from:

<http://www.intechopen.com/books/biomedical-engineering-trends-in-electronics-communications-and-software/cuff-pressure-pulse-waveforms-their-current-and-prospective-applications-in-biomedical-instrumentati>

**INTECH**  
open science | open minds

### **InTech Europe**

University Campus STeP Ri  
Slavka Krautzeka 83/A  
51000 Rijeka, Croatia  
Phone: +385 (51) 770 447  
Fax: +385 (51) 686 166  
[www.intechopen.com](http://www.intechopen.com)

### **InTech China**

Unit 405, Office Block, Hotel Equatorial Shanghai  
No.65, Yan An Road (West), Shanghai, 200040, China  
中国上海市延安西路65号上海国际贵都大饭店办公楼405单元  
Phone: +86-21-62489820  
Fax: +86-21-62489821



© 2011 The Author(s). Licensee IntechOpen. This chapter is distributed under the terms of the [Creative Commons Attribution-NonCommercial-ShareAlike-3.0 License](#), which permits use, distribution and reproduction for non-commercial purposes, provided the original is properly cited and derivative works building on this content are distributed under the same license.

IntechOpen

IntechOpen