

We are IntechOpen, the world's leading publisher of Open Access books Built by scientists, for scientists

5,000

Open access books available

125,000

International authors and editors

140M

Downloads

Our authors are among the

154

Countries delivered to

TOP 1%

most cited scientists

12.2%

Contributors from top 500 universities



WEB OF SCIENCE™

Selection of our books indexed in the Book Citation Index
in Web of Science™ Core Collection (BKCI)

Interested in publishing with us?
Contact book.department@intechopen.com

Numbers displayed above are based on latest data collected.
For more information visit www.intechopen.com



Patch Antennas and Microstrip Lines

John R. Ojha and Marc Peters
Germany

1. Introduction

Microstrip patch antennas have problems of low bandwidths. The aim of this chapter is to show various ways to overcome this problem by using various matching techniques for numerous patch antenna array schemes. Various approaches are used for estimating the figures of merit such as VSWR and the S11 parameter of such antennas. These patch antenna performance characteristics are addressed by simulation techniques using the full-wave method of moments (MoM). Patch antennas are also modelled as a reduced model, in an effective homogeneous dielectric space, to reduce the simulation time. Lastly a more efficient reduced model using special planar Green's functions with and without the use of non radiating networks are explained qualitatively.

2. VSWR, return loss, and bandwidth

Microstrip and coaxially fed patch antennas are commonly used in various type of smart antenna systems. In order for any given antenna to operate efficiently, the maximum transfer of power must take place between the feeding system and the antenna. Maximum power transfer can take place only when the input impedance of the antenna (Z_{in}) is matched to that of the feeding source impedance (Z_s). According to the maximum power transfer theorem, maximum power can be transferred only if the impedance of the source is a complex conjugate of the impedance of the antenna under consideration and vice-versa. If this condition for matching is not satisfied, then some of the power may be reflected back as

$$VSWR = \frac{1 + |\Gamma|}{1 - |\Gamma|}, \quad (1)$$

with

$$\Gamma = \frac{V_r}{V_i} = \frac{Z_{in} - Z_s}{Z_{in} + Z_s}, \quad (2)$$

where Γ is called the reflection coefficient, V_r is the amplitude of the reflected wave, and V_i is the amplitude of the incident wave. The VSWR is basically a measure of the impedance mismatch between the feeding system and the antenna. The higher the VSWR, the greater is the mismatch. The minimum possible value of VSWR is unity and this corresponds to a perfect match. The return losses (RL), obtained from equations (1) and (2), indicate the

amount of power that is transferred to the load or the amount of power reflected back. In the case of a microstrip-line-fed antenna, where the source and the transmission line characteristic impedance or the transmission line and the antenna edge impedance do not match, waves are reflected. The superposition of the incident and reflected waves leads to the formation of standing waves. Hence the RL is a parameter similar to the $VSWR$ to indicate how well the matching is between the feeding system, the transmission lines, and the antenna. The RL is

$$RL = -20 \log |\Gamma| \text{ (dB)}. \quad (3)$$

To obtain perfect matching between the feeding system and the antenna, $\Gamma = 0$ is required and therefore, from equation (3), $RL = \text{infinity}$. In such a case no power is reflected back. Similarly at $\Gamma = 1$, $RL = 0$ dB, implies that all incident power is reflected. For practical applications, a $VSWR$ of 2 is acceptable and this corresponds to a return loss of 9.54 dB. Usually return losses ranging from 10 dB to 12 dB are acceptable.

The most serious limitation of a microstrip antenna is its narrow bandwidth (BW). The bandwidth could be defined in terms of its Voltage Standing Wave Ratio ($VSWR$) or input impedance variation with frequency. The $VSWR$ or impedance bandwidth of a microstrip antenna is defined as the frequency range over which it is matched with that of the feed line within specified limits. Therefore, the BW of a microstrip antenna is inversely proportional to its quality factor Q and is

$$BW = \frac{VSWR - 1}{Q\sqrt{VSWR}}. \quad (4)$$

The bandwidth is usually specified as the frequency range over which the $VSWR$ is less than 2 (which corresponds to a return loss of 9.5 dB or 11 % reflected power). Sometimes for stringent applications, the $VSWR$ requirement is specified to be less than 1.5 (which corresponds to a return loss of 14 dB or 4 % reflected power). In the case of a patch antenna, the input impedance with the source impedance is used as an intermediate parameter for determining the S_{11} parameter (a measure of the reflection coefficient Γ), return loss, Voltage Standing Wave Ratio ($VSWR$), and bandwidth. The return loss is expressed in dB in terms of S_{11} as the negation of the return loss. The bandwidth can also be defined in terms of the antenna's radiation parameters such as gain, half power beam width, and side-lobe levels within specified limits.

3. Matching of Microstrip Lines

Matching of microstrip transmission lines is done by matching each line to the source, its interconnecting transmission lines, and to the edge of a patch antenna. The patch antenna edge connected to the transmission lines is given an inset to match the radiation edge impedance of the patch antenna to the characteristic impedance of the transmission line.

3.1 Matching of microstrip lines to the source

The characteristic impedance of a transmission line of a microstrip feed patch is designed with respect to the source impedance. The characteristic impedance Z_0 of the transmission line with respect to the source impedance Z_S is

$$Z_0 = n \cdot Z_s, \quad (5)$$

where the factor n is the number of twigs emanating from a node connected to a source. It follows that the characteristic impedance for a single, duplex, and quadruple antenna, illustrated in figure 1 is 50, 100, and 200 ohms respectively. The above equation can be illustrated by considering a 2×2 antenna array as shown in figure 2 where an edge feed is matched to a source impedance of 50 ohms. The transmission lines from the source therefore have an impedance of 100 ohms. Similarly the characteristic impedance of the transmission line feeding the antennas is 200 ohms.

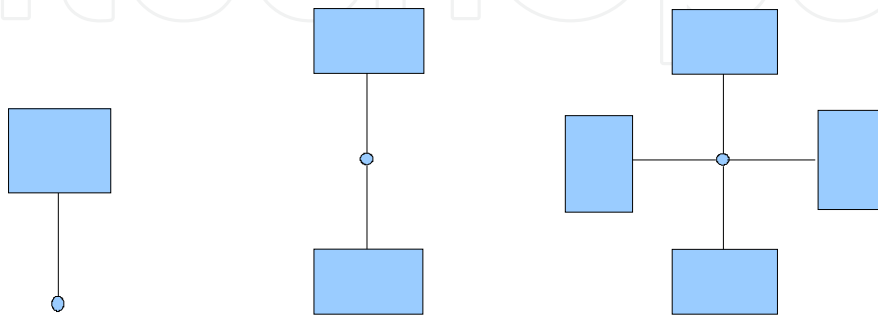

Fig. 1. Characteristic impedances with respect to a 50-ohms source impedance for a (a) single antenna, (b) duplex antenna, and (c) quadruple patch antenna.

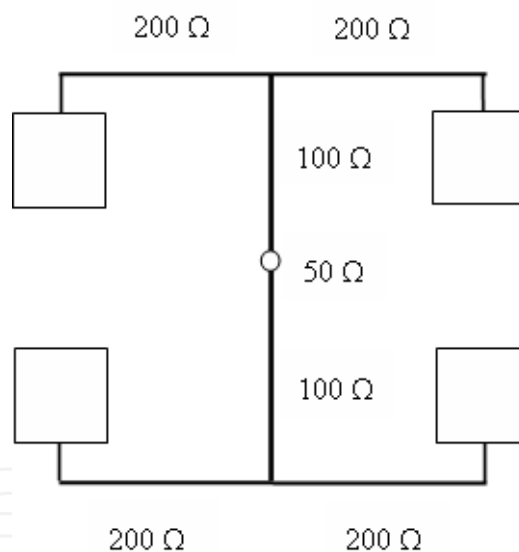

Fig. 2. Matching network of a 2×2 microstrip patch antenna array.

The characteristic impedance of a transmission line therefore depends on the source impedance as well as the number of patch antennas as shown in figure 2. The width of the transmission line w is designed from the empirical relation

$$Z_o = \frac{42.4 \Omega}{\sqrt{\epsilon_r + 1}} \ln \left[1 + C_c \left\{ (C_c \cdot C_d) + \sqrt{(C_c \cdot C_d)^2 + \frac{\pi^2}{2} \cdot \left(1 + \frac{1}{\epsilon_r} \right)} \right\} \right], \quad (6)$$

where C_c and C_d are expressed in terms of line width w , substrate thickness d , and relative permittivity ϵ_r as $C_c = \frac{14 + \frac{8}{\epsilon_r}}{11}$ and $C_d = \frac{4d}{w}$.

3.2 Matching of microstrip lines to the patch edge

In most microstrip patch antennas the feed line impedance is 50Ω whereas the radiation resistance at the edge of the patch is on the order of a few hundred ohms depending on the patch dimension and the substrate used. The performance of the antenna is affected due to this mismatch since the maximum power is not being transmitted. A matching network must therefore be implemented on the feed network, in order to minimise reflections, thereby enhancing the performance of the antenna.

A typical method used for achieving such an antenna is by providing an inset feed. The inset feed distance x_0 can be set such that the feeding edge of the antenna can be matched to the characteristic impedance of the transmission line. The input resistance for an inset fed patch (see figure 3) is given by

$$R_{in}(x = x_0) = \frac{1}{2(G_1 + G_{12})} \cos^2\left(\frac{\pi x_0}{L}\right), \quad (7)$$

where G_1 is expressed in terms of the antenna width W and the propagation constant k_0 in free space. The inset patch antenna is designed with respect to the characteristic impedance of the transmission line at the resonance frequency of the patch and therefore the imaginary part is zero. The mutual conductance G_{12} is negligible with respect to G_1 for microstrip patch antennas.

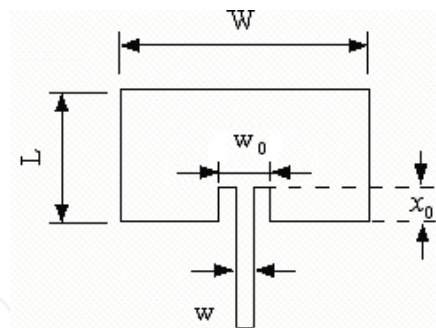

Fig. 3. Microstrip-line-fed inset patch antenna.

4. Design guidelines for patch antenna arrays

For a given center frequency and substrate relative permittivity, the substrate height should not exceed 5% of the wavelength in the medium. The following guidelines are a must for designing patch antenna arrays fed by microstrip lines.

- The length of the patches may be changed to shift the resonances of the centre fundamental frequency of the individual patch elements. The resonant input resistance of a single patch can be decreased by increasing the width of the patch. This is acceptable as long as the ratio of the patch width to patch length (W/L) does not

exceed 2 since the aperture efficiency of a single patch begins to drop, as W/L increases beyond 2.

- To increase bandwidth, increase the substrate height and/or decrease the substrate permittivity (this will also affect resonant frequency and the impedance matching).
- To increase the input impedance, decrease the width of the feed lines attached directly to the patches as well as the width of the lines attached to the port. The characteristic impedance of the quarter-wave sections should then be chosen as the geometric mean of half the impedance of the feed lines attached to the patches and the impedance of the port lines.

Antenna Magus (see figure 4) is a software tool that helps choose the appropriate antenna for a given application and estimates the S_{11} / VSWR and the far field gain characteristics.

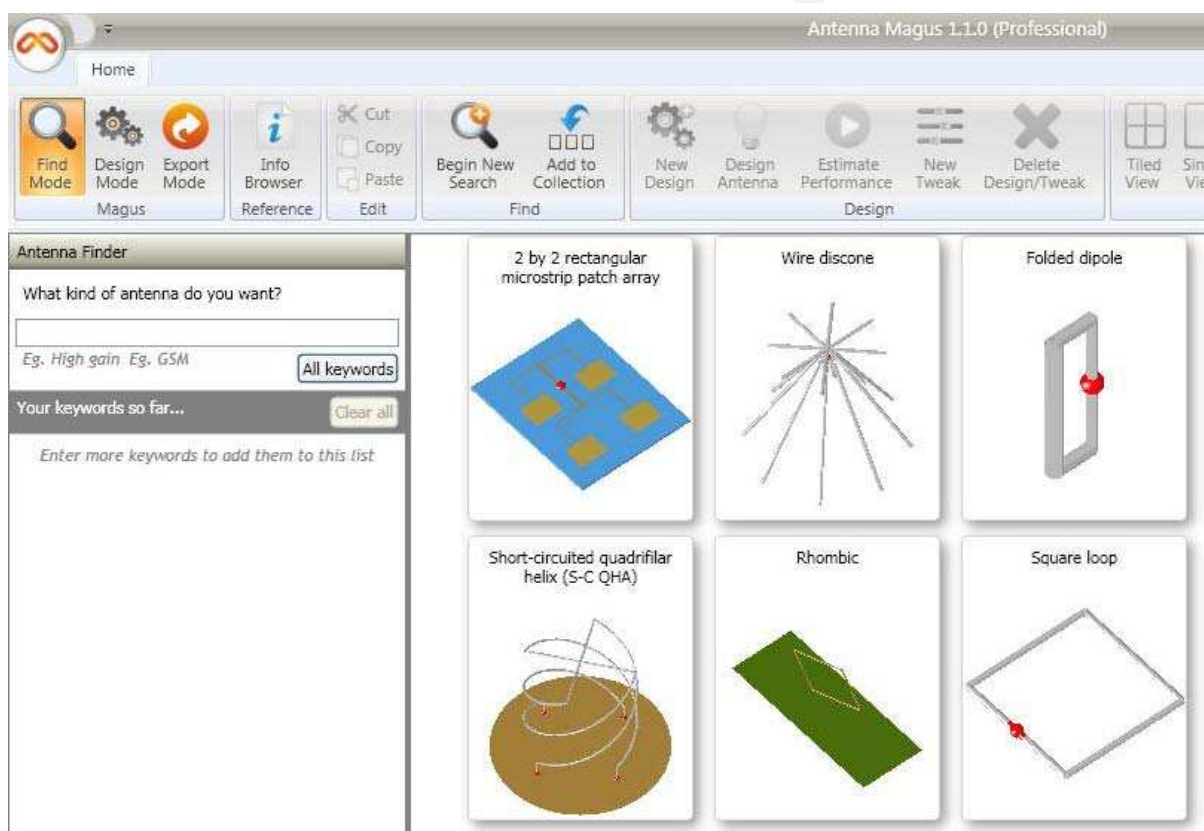

Fig. 4. Microstrip-line-fed inset patch antenna selected from Antenna Magus.

Caution: Antennas on very thin substrates have high copper-losses, while thicker and higher permittivity substrates may lead to performance degradation due to surface waves. The transmission line must be matched to the source as well as to the patch in order to improve the bandwidth and have an acceptable level of VSWR at the centre frequency. The earlier subsection 3.1 explained the approach of matching the transmission line to the source. Figure 5 shows the schematic layout of a patch antenna using the transmission line model where Z_L represents the load impedance or input impedance of the patch antenna. The matching of the transmission line to the patch antenna was explained earlier in section 3.2.

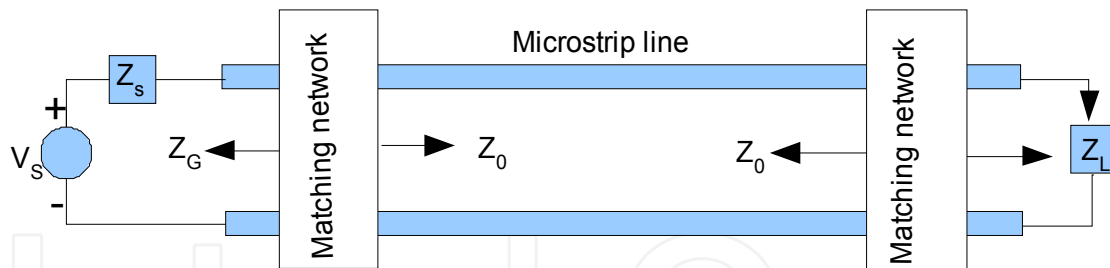

Fig. 5. Transmission line model of a matched patch antenna.

5. Matching of microstrip lines

5.1 Dual Band Antenna Array

In this section an 8×2 inset patch antenna array, shown in figure 6, is discussed, which is designed for a dual band of 1.9 GHz and 2.1 GHz used in UMTS applications. In order to achieve a dual band, the antenna array is designed such that for a 16 patch configuration, half the number of patches i.e. 8 patches are designed to radiate at 1.9 GHz and the remaining 8 patches are designed to radiate at 2.1 GHz as shown in figure 7. Table 1 shows the size of the patch antenna in terms of its dimensions and inset length, where the patch antenna lengths, $L1 = 39.6$ mm and $L2 = 35.9$ mm, are designed to resonate at 1.9 GHz and 2.1 GHz, respectively.

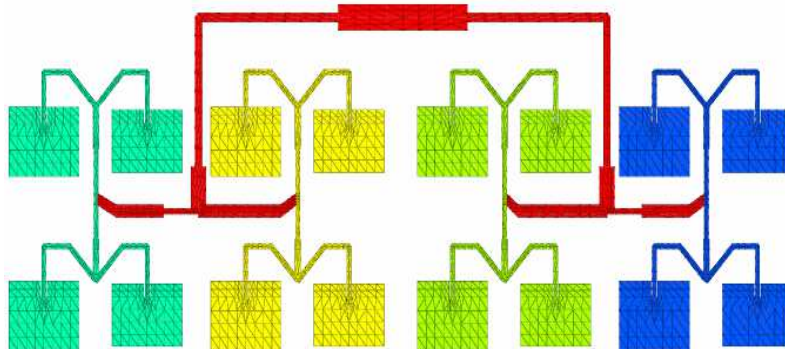

Fig. 6. A discretized structure of a dual band antenna array.

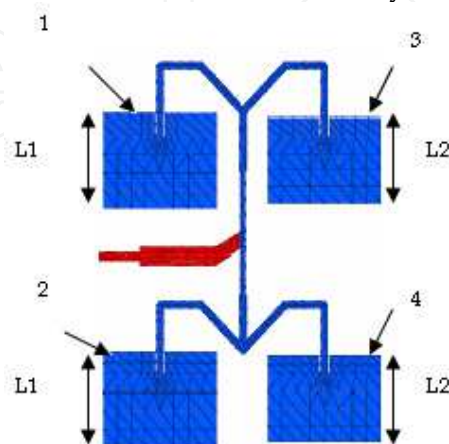

Fig. 7. Array section showing two sets of patch antenna sizes.

Patch number	x_0 (mm)	w (mm)	w_0 (mm)	L (mm)	W (mm)	f (GHz)	$R_{in}(x = x_0)$ (Ω)
1	9.3	3	3.2	39.6	52	1.9	99.2
2	9.3	3	3.2	39.6	52	2.1	90.25
3	7.7	3	3.2	35.9	52	1.9	111.25
4	7.7	3	3.2	35.9	52	2.1	100.60

Table 1. Inset depths of various patches of an 8×2 patch antenna array as a function of antenna length and frequency.

The transmission line width $w = 3$ mm (figure 3) is obtained from equation 6 for a substrate thickness and dielectric constant of 6 mm and 3 respectively. The width is designed for a characteristic impedance to match the antenna array system shown in figure 7. The antenna array system is matched at 1.9 GHz and 2.1 GHz so that the input resistance at the edges of the patch antenna, obtained from equation 7, is 100Ω (Table 1). A comparison will be made in the next subsections with respect to the reduced model and the full model, for the S11 parameter and the VSWR. The effective permittivity ϵ_{reff} used in the reduced model is 0.78 times ϵ_r used in the full-wave MoM. These approaches are explained later in this chapter.

5.2 Broadband Antenna Array

It was seen in section 5.1 that for an 8×2 patch antenna array, the use of different patch size combinations were used for a dual band antenna. In this section all antenna sizes in the array are identical. Broad band characteristics are achieved by following the basic guidelines mentioned in the earlier sections viz. that the characteristic impedance of the transmission line must match the source impedance as well as the impedance at the feeding edge of the patch. This is obviously a significant advantage of an inset patch antenna over a conventional microstrip antenna. The drawback of microstrip lines over a coaxially fed patch antenna is that for a given patch antenna array the width of the transmission lines decreases as the number of antennas increase, and therefore the fabrication of a patch antenna becomes impossible if the number of antennas illustrated in section 2 in figure 1 (a) to (c) exceeds 4. The parameter values given in table 2 for these schemes hold good for the most commonly used substrate thickness of 1.59 mm for patch antennas having a dielectric constant of 2.32.

No. of patch antennas	Z_s (ohms)	Z_0 (ohms)	w (mm)
1	50	50	4.61
2	50	100	1.30
4	50	200	0.15

Table 2. Microstrip line width with respect to antenna array size.

For a larger antenna array, the size of the microstrip lines would be much less than 0.1 mm making fabrication of such an array impossible. A quarter wave transformer is therefore included in an array of 16 antennas e.g. 4×4 microstrip fed patch antenna array, to

overcome this problem, where a 200 ohm line which feeds the patch antenna is matched to the source impedance via 100 ohms feed lines as shown in figure 8 (a). The discretised model of such a scheme is shown in figure 8 (b). The patch antenna sizes are (4 cm x 4 cm). The effective permittivity ϵ_{eff} used in the reduced model is 0.85 times ϵ_r .

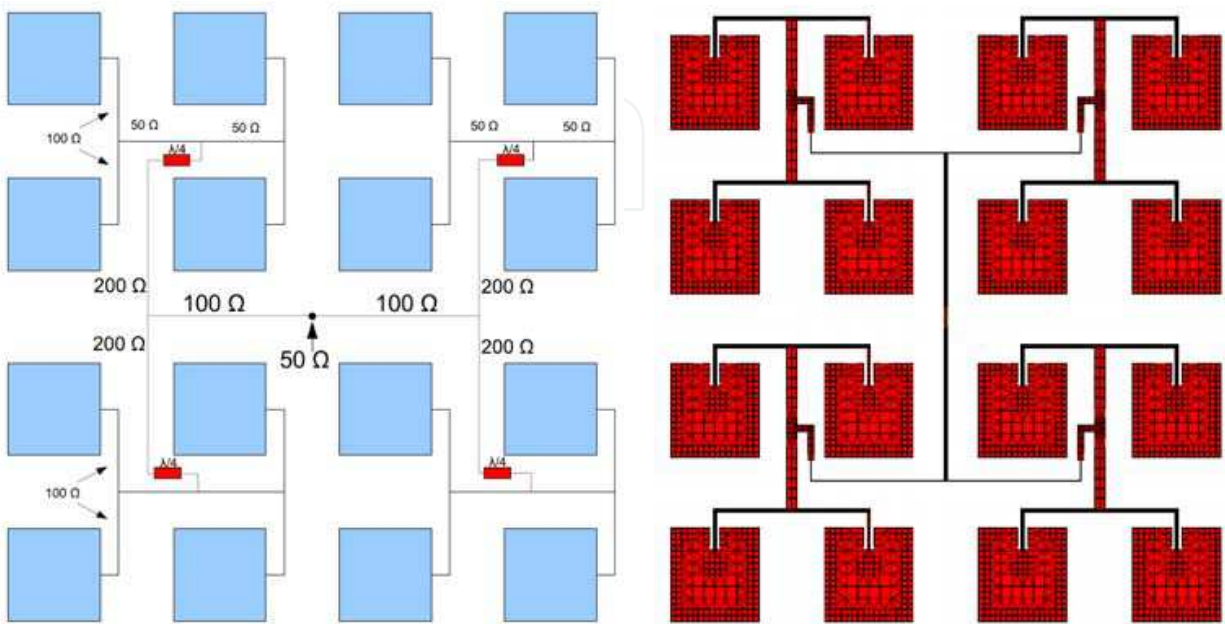

Fig. 8. 4 x 4 patch antenna array using a quarter wave transformer: (a) Schematic diagram and (b) discretised model.

5.3 Results of a Dual band and Broad band Antenna Array -

The VSWR and S11 are obtained using the full-wave MoM and the reduced model for the above designed dual band and broad band antennas. These are explained briefly in the next sections.

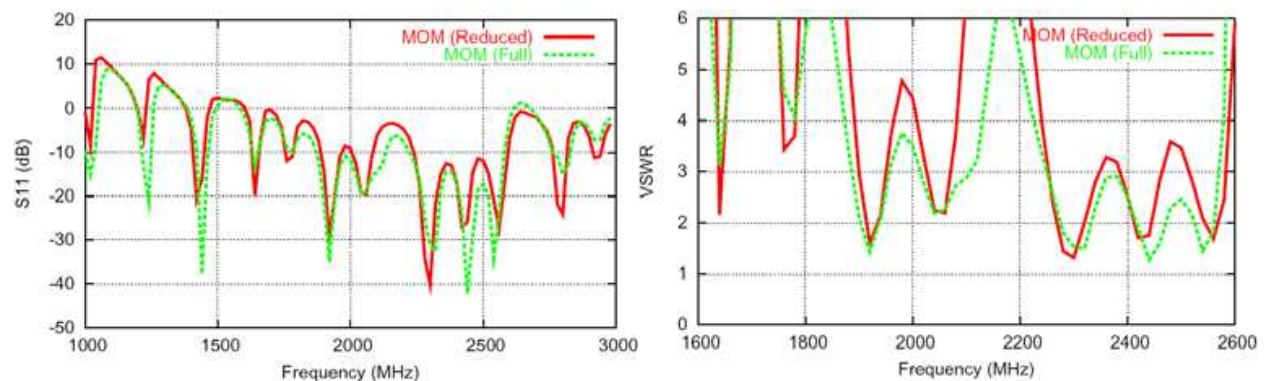

Fig. 9. (a) S11 characteristics and (b) VSWR characteristics of the full model and the reduced model of a 8x2 dual band antenna array.

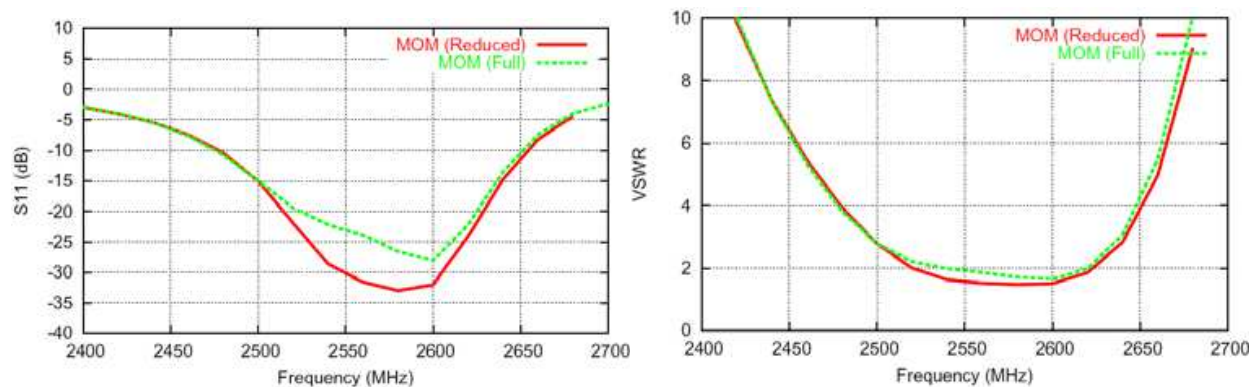

Fig. 10. VSWR characteristics of the full model and the reduced model of a 4x4 broadband antenna array using a quarter wave transformer.

In this section it can be seen that although the patch sizes in section 5.2 are identical, the bandwidth is broader than that of the array shown in section 5.1. This is due to good matching between the source and the transmission lines as well as between the transmission lines and the patch edge. Better broadband characteristics are still possible if the two-patch-size combination is adopted provided that the disparities in the patch lengths do not vary appreciably. For larger variations in patch lengths, thicker substrates are recommended. In section 5.1 the two-patch-size combination has been adopted. However, due to the large difference in patch lengths, a dual band is obtained instead of a broadband, even for a substrate thickness of 6 mm. It can be concluded that a combination of the two-patch-size approach indicated in section 5.1 and the line-to-source and line-to-patch matching approach, along with a quarter wave transformer in section 5.2 would give the best antenna characteristics. The improvement in bandwidth characteristics indicated in figure 10 with respect to figure 9 indicates the importance of providing a quarter wave transformer in terms of the return loss and bandwidth characteristics. The absence of a quarter wave transformer leads to undesirable values of return loss in the frequency spectrum of interest.

5.4 Full-wave method of moments (MoM)

The MoM analysis can be carried out either in the spectral or in the time domain. The spectral / frequency domain has an advantage in that the spectral Green's function is obtained and calculated more easily and hence the spectral approach is employed. A patch antenna comprising metallic and dielectric parts with a feeding pin or microstrip line is solved using the traditional MoM by decomposing the antenna as

- discretized surface parts
- wire parts
- attachment node of the wire to the surface element.

Metallic surfaces contain basis functions as shown in figure 11. The MoM uses surface currents to model a patch antenna. In the case of ideal conductors, the boundary condition of $E_{\text{tan}} = 0$ is applied

The most commonly used basis functions for line currents through wires are stair case functions, triangular basis functions, or sine functions. The MoM code uses triangular basis functions. In contrast to wires, two-dimensional basis functions are employed for surfaces. The current density vectors have two-directional components along the surface. Figure 11 shows the overlapping of so-called hat functions on triangular patches. An integral equation is formulated for the unknown currents on the microstrip patches, the feeding wire / feeding transmission line, and their images with respect to the ground plane. The integral equations are transformed into algebraic equations that can be easily solved using a computer. This method takes into account the fringing fields outside the physical boundary of the two-dimensional patch, thus providing a more exact solution. The coupling impedances Z_{ik} are computed in accordance with the electric field integral equation.

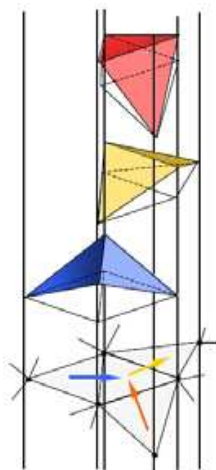

Fig. 11. Hat basis functions on discretised triangular elements on patches.

The MoM uses either surface-current layers or volume polarization to model the dielectric slab. In the case of dielectric materials we have to consider 2 boundary conditions

$$\vec{n} \times \vec{E}_1 = \vec{n} \times \vec{E}_2, \quad (8)$$

$$\vec{n} \times \vec{H}_1 = \vec{n} \times \vec{H}_2. \quad (9)$$

The traditional full-model applied in the MoM code uses a surface-current approach which is categorised as

- double electric current layer approach or
- single magnetic and electric current layer approach.

5.5 Reduced model

Unlike the full model (figure 12 a), which involves the discretisation of metallic and dielectric surfaces, the reduced model involves only the discretisation of metallic parts in a

homogeneous dielectric medium (figure 12 b), having equivalent values of dielectric constant and loss angle with respect to the dielectric slab used in the full model. The reduced model therefore provides the flexibility of the numerical approach, but keeps the modelling effort and computation at a reasonable degree with lesser simulation time.

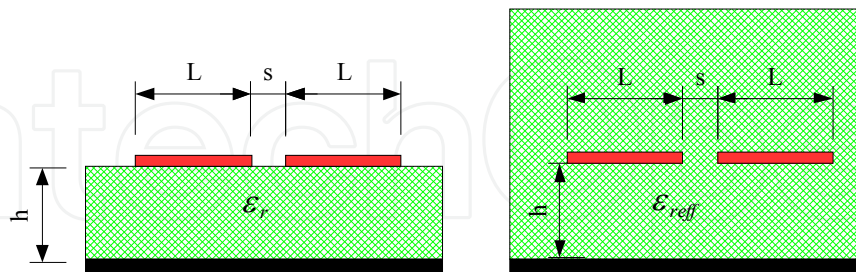

Fig. 12. Patch antenna array modelled as (a) full and (b) reduced model

As mentioned earlier, the greatest drawback of a patch antenna is its narrow bandwidth. Steps were taken to broaden the antenna bandwidth. Two methods were used to study the antenna characteristics viz. the reduced model and the full model. The reduced model shows accurate results with respect to the full-wave model. The full model used in section 5.2 for the broad band antenna comprises approximately 40,000 unknowns and consumes a large memory space of 32 GB since the microstrip lines and the surrounding dielectric surfaces surrounding it have to be finely discretised. The reduced model on the other hand occupies 7000 unknowns and requires less than 2 GB of memory space. Despite these merits viz. speed, accuracy, and storage space its greatest drawback is that of modelling the effective permittivity. The reduced model, which appears to overcome the problem of the full model, is of historical importance since it is not easy to form empirical formulae with respect to the effective permittivity for every antenna shape. This becomes even more complicated especially for inset fed patch fed antennas or patch antennas fed by microstrip lines. The next section deals with an example which makes use of special planar Green's functions which overcomes the problem of the reduced model.

6. Modelling of a circular polarized antenna using non radiating networks

A right hand circularly (RHC) polarised patch antenna at 2.4 GHz is simulated by making use of planar special Green's functions available in FEKO. This approach can in a way be also viewed as a reduced model since only the metallic parts are discretized. The dielectric parts (substrate) and ground plane are imaginary and extend to infinity as shown in figure 13. The model can be further reduced by partitioning the model so that the feed network is characterised as S-parameters which are stored in a Touchstone file. The Touchstone file is then used as a non-radiating network to feed the patch. The input impedance as well as the simulation time and memory required for the two reduced methods (section 6.2 and 6.3) are compared. We will see that subdividing the problem greatly reduces the required resources and simulation time.

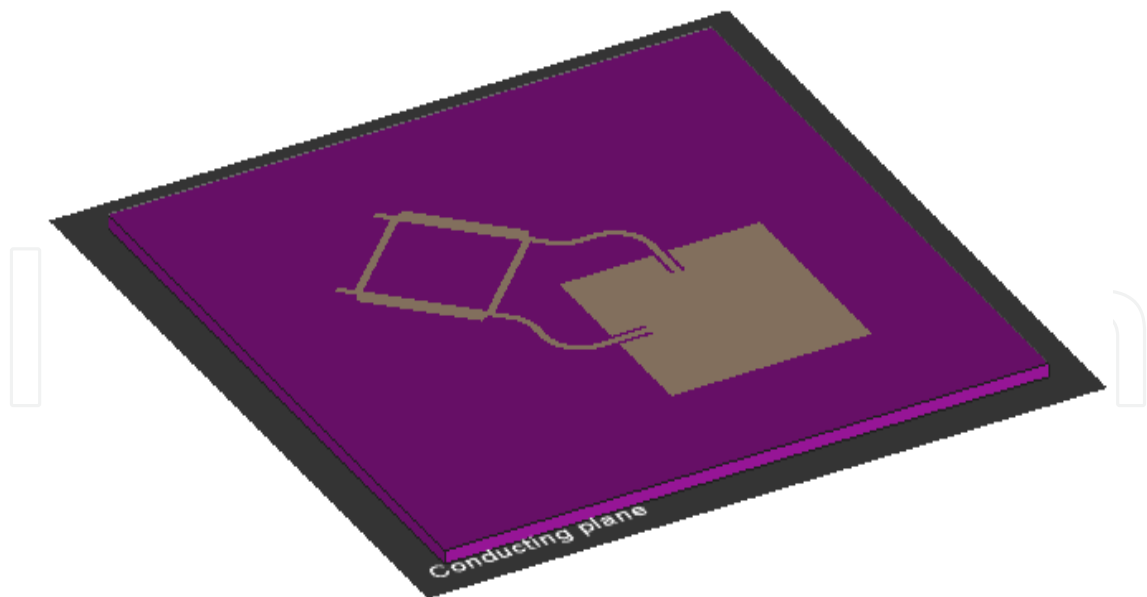

Fig. 13. The model of a RHC patch antenna with feed network.

6.1 Feed network

The feed network consists of a branch line coupler that divides the power evenly with 90 degree phase difference between the outputs. The output signals are then extended to the patch-feed interfaces using microstrip transmission lines. The entire system is designed in a 120Ω system (system or reference impedance).

6.2 Patch with non-radiating feed network

The feed network for the patch antenna is simulated and characterised and its results are saved in a Touchstone file in the form of either S parameters. The stored data which models a non-radiating network is combined with the patch antenna. Effective modelling is also possible by replacing a passive source with an active source e.g. patch antennas fed by a transistor amplifier

6.3 Patch with radiating feed network

The required memory space with the 3D simulation is more as compared to the non-radiating network. The advantage of using the radiated feed networks is that the coupling between the feeding network and the patch antenna is taken into account.

6.4 Results

The difference in solution time and memory requirements is shown in Table 3. We see that the solution time is almost halved by subdividing the problem. Since the field coupling between the feed and the patch cannot be taken into account when substituting the feed with a general non-radiating network, the results are slightly different as seen in figure 14. Although the model with non radiating networks is less accurate, simulation time is saved considerably since only the patch needs to be discretized and not the feeding network. The advantage of memory space and simulation time becomes clear in table 3.

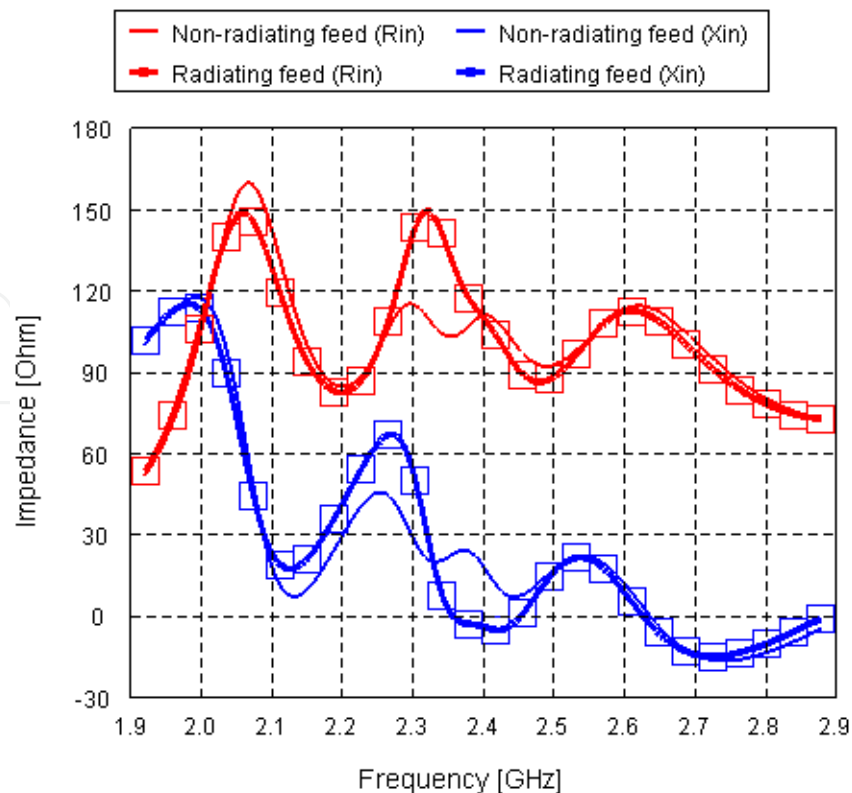

Fig. 14. Input impedance (real and imaginary) of the path with radiating and non-radiating feed.

Verification can also be done using a full 3D field solution comprising the patch, finite substrate, finite ground plane and the feed network. In the case of a full 3D field solution all the aforesaid components have to be discretized.

<i>Model</i>	<i>Memory</i>	<i>Time</i>	<i>Total Time</i>
Full model	7.6 Mb		412
Network only	3.5 Mb	202	
Patch with general network	4.3 Mb	23	225

Table 3: Comparison of resources for the simulations.

7. References

- Balanis, C. A. (2005). *Antenna Theory, Analysis and Design*, Wiley & Sons, Artech House, ISBN 978-0471603528, USA.
- Kumar, G. & Ray, K.P. (2003). *Broadband Microstrip Antennas*, Artech House, ISBN 978-1580532440, USA.
- Garg, R. (2001). *CAD for Microstrip Antennas Design Handbook*, Artech House, ISBN, Artech House
- Sainati, R. A. (1996). *CAD for Microstrip Antennas for Wireless Applications*, Artech House, Publisher, ISBN 978-0890065624, Boston.
- Bancroft, R. (1996). *Understanding Electromagnetic Scattering Using the Moment Method – A Practical Approach*, Artech House, ISBN 978-0890068595, Boston.

Refer to FEKO by using the following information: Author: EM Software & Systems - S.A. (Pty) Ltd Title: FEKO (www.feko.info) Suite: (the suite number reported by FEKO) Publisher: EM Software & Systems - S.A. (Pty) Ltd Address: PO Box 1354, Stellenbosch, 7599, South Africa

Refer to Antenna Magus by using the following information: Author: Magus (Pty) Ltd Title: Antenna Magus (www.antennamagus.com) Version: (the version number reported by Antenna Magus) Publisher: Magus (Pty) Ltd Address: PO Box 1354, Stellenbosch, 7599, South Africa

IntechOpen

IntechOpen



Microwave and Millimeter Wave Technologies Modern UWB antennas and equipment

Edited by Igor Mini

ISBN 978-953-7619-67-1

Hard cover, 488 pages

Publisher InTech

Published online 01, March, 2010

Published in print edition March, 2010

How to reference

In order to correctly reference this scholarly work, feel free to copy and paste the following:

John R. Ojha and Marc Peters (2010). Patch Antennas and Microstrip Lines, Microwave and Millimeter Wave Technologies Modern UWB antennas and equipment, Igor Mini (Ed.), ISBN: 978-953-7619-67-1, InTech, Available from: <http://www.intechopen.com/books/microwave-and-millimeter-wave-technologies-modern-uwband-antennas-and-equipment/patch-antennas-and-microstrip-lines>

INTECH

open science | open minds

InTech Europe

University Campus STeP Ri
Slavka Krautzeka 83/A
51000 Rijeka, Croatia
Phone: +385 (51) 770 447
Fax: +385 (51) 686 166
www.intechopen.com

InTech China

Unit 405, Office Block, Hotel Equatorial Shanghai
No.65, Yan An Road (West), Shanghai, 200040, China
中国上海市延安西路65号上海国际贵都大饭店办公楼405单元
Phone: +86-21-62489820
Fax: +86-21-62489821

intechopen

© 2010 The Author(s). Licensee IntechOpen. This chapter is distributed under the terms of the [Creative Commons Attribution-NonCommercial-ShareAlike-3.0 License](#), which permits use, distribution and reproduction for non-commercial purposes, provided the original is properly cited and derivative works building on this content are distributed under the same license.

IntechOpen

IntechOpen