

We are IntechOpen, the world's leading publisher of Open Access books Built by scientists, for scientists

5,400

Open access books available

134,000

International authors and editors

165M

Downloads

Our authors are among the

154

Countries delivered to

TOP 1%

most cited scientists

12.2%

Contributors from top 500 universities



WEB OF SCIENCE™

Selection of our books indexed in the Book Citation Index
in Web of Science™ Core Collection (BKCI)

Interested in publishing with us?
Contact book.department@intechopen.com

Numbers displayed above are based on latest data collected.
For more information visit www.intechopen.com



WiMAX-WiFi Synergy for Next Generation Heterogeneous Network

Dr. Rashid A. Saeed, Amran Naemat, Azrin Aris and Mat Kamil Awang
*Telekom Malaysia, TMRND innovation centre, 63000 Cyberjaya,
Malaysia*

1. Introduction

Networks integration is crucial criterion for next generation wireless networks, where the diverse of the technologies available has been optimized for different usage models. WiMAX and WiFi are the most promising techniques for future wireless networks; interworking between these technologies is inevitable for better usability of the networks infrastructure and support for seamless mobility and roaming. The unique similarities between WiMAX and WiFi networks that make the proposed synergy promising and meaningful that both technologies are fully packet switching uses IP-based technologies to provide connection services to the Internet. This standards- and IP-based network approaches provide compelling benefits to service providers to collaborate between these technologies.

By distributing high-speed Internet access from cable, Digital Subscriber Line (DSL), and other fixed broadband connections within wireless hotspots, WiFi has dramatically increased productivity and convenience. Today, there are nearly pervasive WiFi delivers high-speed Wireless Local Area Network (WLAN) connectivity to millions of offices, homes, and public locations, such as hotels, cafés, and airports. The integration of WiFi into notebooks, handhelds and Consumer Electronics (CE) devices has accelerated the adoption of WiFi to the point where it is nearly a default feature in these devices (Xu and Saadawi 2001). On the other hand, WiMAX takes wireless Internet access to the next level, and over time, could achieve similar rates to devices as WiFi. WiMAX can deliver Internet access miles from the nearest WiFi hotspot and blanket large areas called wide area networks (WANs), be they metropolitan, suburban, or rural with multi-megabit per second mobile broadband Internet access (Sundaresan et al., 2004), also see table 2. Although the wide area Internet connectivity offered by 2.5 and 3G cellular data services are mobile, these services do not provide the broadband speeds to which users have become accustomed and that WiMAX can deliver. In the last few years, WiMAX has established its relevance as an alternative to wired DSL and cable, providing a competitive broadband service offering that can be rapidly and cost effectively deployed (Gunasekaran and Harmantzis, 2005).

The unique similarities between WiMAX and WiFi networks that make the proposed synergy is promising is both technologies are fully packet switching uses IP-based technologies to provide connection services to the Internet. This standards- and IP-based network approach provides compelling benefits to service providers to collaborate between these technologies (Niyato, Hossain, 2004):

- A common user experience for wireless broadband services, which is a critical enabler in attaining rapid user adoption.
- An open network philosophy where any WiMAX or WiFi device is able to connect to any WiMAX or WiFi network that supports the same network setting, improving today's business models for delivering mobile broadband services.
- Vendor agreed-upon certification profiles, facilitating volume production and global economies of scale. Wireless client and network equipment subjected to extensive interoperability and conformance testing, enabling an open and competitive multi-vendor environment.
- An all-IP based network infrastructure, enabling cost-effective deployments for operators and open Internet services for users

Feature	WiFi 802.11 a/b/g	WiMAX
Rang	Very small Optimized for 100 m	Considerably larger Optimized for 7 - 10 km Up to 50 km range
Indoor vs. outdoor	Preferably Indoor PHY tolerates only low multi-path delay spreads	Indoor (16a) Outdoor (16, 16e) PHY tolerates high multi-path delay spread (10 μ sec = Trees, buildings, persons)
Scalability	Poor Fixed bandwidth of 20 MHz Fixed channels Certain degree of channel overlap	Excellent Variable bandwidth 1.5 MHz - 20 MHz Only limit is available spectrum
Bandwidth	Unlicensed bands	Licensed and unlicensed bands
Sensing	Low to medium 1 Mbps - 11 Mbps - 54 Mbps - 108 Mbps. Efficiency 2,7 bps / Hz peak	High 75 - 100 Mbps - 134 Mbps Efficiency 5 bps / Hz
Layer	Contention based MAC: CSMA / CA	Grant based MAC (TDM/TDMA)
Security	Mostly questionable Various attempts on improvements WEP, WPA	Supposedly good Nevertheless flawed in principle 3DES, AES
QoS	poor QoS, 802.11e using the Hybrid Coordination Function (HCF).	Good QoS 4 QoS classes for voice & video

Table 1. Comparison of WiFi, WiMAX and Cellular IP

This chapter explores the complementary nature of WiMAX and WiFi, as well as illustrates how service providers can leverage these technologies to offer wireless broadband Internet connectivity and compelling new services at affordable prices and in more locations. It also focuses on the synergies between the IEEE 802.11n and IEEE 802.16e-2005. The draft IEEE 802.11n standard is a new high-throughput enhancement designed for digital home and office applications based on orthogonal frequency division multiplexing (OFDM) modulation. IEEE 802.16e-2005 is the mobile enhancement to IEEE 802.16-2004 and is designed to support wide area mobility via scalable OFDMA technology. Both of these technologies leverage OFDM and advanced antenna innovations to attain high-broadband data rates and improved signal reception.

2. Interoperability Opportunities and Challenges

The industrial implementation of IEEE 802.11 (WLAN) and IEEE 802.16 (WirelessMAN) standards are referred to as WiFi and WiMAX, respectively (Dhawan, (2007)). The protocols of 802.16 and 802.11 have fundamental differences in their MAC layers: While 802.16 is a frame-based, centrally coordinated MAC protocol, 802.11 allows distributed control and a contention-based medium-access. In addition, 802.11 also realize a contention-free, centrally controlled access to the channel. Both 802.16 and 802.11 have a similar OFDM-based transmission scheme and channelization which facilitates their interworking (Man et al., 2007). The integration of 802.16 and 802.11 implies interworking between similar and different types of devices in a common protocol. The network is coordinated by central coordinator, which combines the 802.16 BS with the point coordination function (PCF) of 802.11 (a.k.a. infrastructure mode) and is thus referred to as WiWi BS or WiWi module in the MS. WiWi is abbreviation for WiMAX/WiFi project running in MIMOS Berhad since 2007 (MIMOS, 2009). WiWi is capable of operating in both 802.16 and 802.11 mode. In (Berlemann et al., 2006) the authors called it as Base Station Hybrid Coordinator (BSHC) where the interworking is based on an integration of 802.11 transmission sequences into the MAC frame structure of 802.16. Note that the distributed coordination function (DCF) is difficult to be implemented in BSHC and WiWi due to its random behaviour. In BSHC, an optional period for contention-based access maybe placed between two consecutive 802.16 MAC frames. While WiWi based on protocol encapsulation.

The integration of 802.11 and 802.16 into one WiFi/WiMAX module has been discussed extensively in the literature (Behmann, 2005); (Jong-Ok, 2004); (IEEE Std 802.16g, 2009), which all are work for the realization of an interworking between these two standards. In (Behmann, 2005) a common framework was introduced, that allows the operation of 802.11 and 802.16 with optimal bandwidth sharing. Game theory and genetic algorithm have been used to analyze and obtain the optimal pricing for bandwidth sharing between a WiMAX BS and WiFi APs, taking into account the bandwidth demand of the WiFi users. In (Jong-Ok, 2004) airtime-based link aggregation for WiFi and WiMAX was discussed. The airtime cost was used to measure the available resource of heterogeneous wireless links and it calculated on a packet basis for single user.

IMS convergence	Upper layers		SIP convergence
MIH (802.21, 802.11u, 802.16g)			
MAC Convergence (Adaptation) sublayer			
802.16 (MAC)		802.11 (MAC)	
Common Transmission Convergence sublayer			
802.16 (PHY)		802.11 (PHY)	

Fig. 1. The potential protocol stack WiMAX/WiFi integration

Figure 1 illustrates the integration of WiMAX and WiFi from OSI layered architecture perspective from upper layers down to physical layer.

The integration and convergence can be done in many places in the OSI model. The easiest way is to go for upper layer, where all the implementation will be based on the software. Software design is more flexible and robustness than hardware design. However, more delay and jitter will be experimented. On the other hand, the fastest integration solution is working at lower layers (i.e. MAC and PHY), but at the expense of complexities to the system. One of the most popular solutions now a day is implementing IMS (IP multimedia Subsystem) at the application layer. The IP Multimedia Subsystem (IMS) (3GPP, 2007) defined by 3GPP provides an enabling architecture that is access independent which is considered central in the move towards convergence. At the application layer SIP (session initiation protocol) sublayer from IETF under the Request for Comments (RFC) 3261 (Gaitan et al., 2005); (Gaitan et al., 2005), provides converged and unified communication services, such as voice and video conversations.

3. PHY Layer Integration

There are many similarities between WiFi and WiMAX at the PHY and MAC layers perspectives which both are IEEE 802[®] LAN/MAN standards, where there are many same design concepts also some features are polled from 802.11 to 802.16. At the MAC layer, the Media Independent Handover (MIH) protocol developed by IEEE 802.21 group enables the handover of IP sessions from one layer 2 access technology to another, to achieve mobility of end user devices (Lampropoulos et al., 2007). MIH is discussed in section 3.

At the physical layer, both 802.16 and 802.1 are uses the orthogonal frequency division multiplexing (OFDM) transmission concepts i.e. mobile WiMAX is using orthogonal frequency division multiplexing access (OFDMA) techniques (Surducan et al., 2007). The convergence at physical layer will reduce the base-station cost significantly where the base station can use the same IF, RF, and antenna parts for both technologies. This concept is illustrated in Figure 2. However, the integration at PHY level needs a change on the silicon

chip which increases the complexity of the baseband chip (Zlydareva, Sacchi, 2008). This can be realized by implementing Software defined radio (SDR) technique to switch between the two techniques at base band (BB) and RF levels where components that have typically been implemented in hardware (i.e. mixers, filters, amplifiers, modulators/demodulators, detectors. etc.) are instead implemented using software on the base-station baseband. Implementing cognitive radio can help the integration at the RF level. In this chapter we focused and proposed a new handover algorithm that works above the MAC layer. The realization of the interworking of the algorithm is discussed and evaluated in the next two sections.

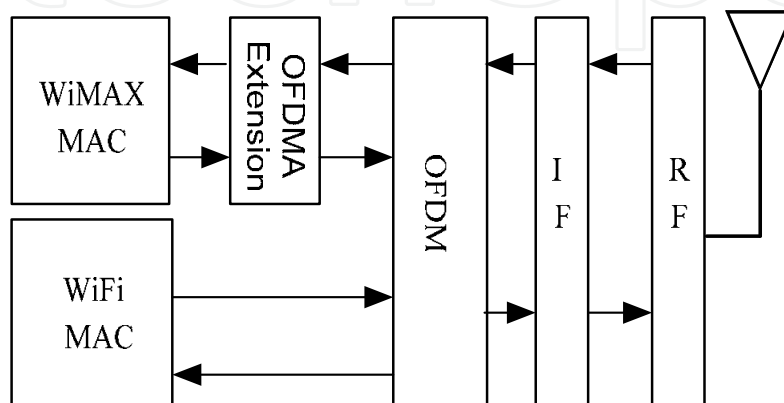

Fig. 2. the integration of WiMAX and WiFi PHY layer at the baseband level

Software Define Radio, SDR system is a radio communication system where components that have typically been implemented in hardware (e.g. mixers, filters, amplifiers, modulators/demodulators, detectors. etc.) are instead implemented using software on a personal computer or other embedded computing devices. Which is enables feature-rich services deployment for the increasing flexibility and mobility demands of enterprise and residential broadband users. SDR technology provides highly granular control over all radio system domains, including frequency, time, modulation, power, space, and coding. The result is a deployment and user experience agile enough for the rapidly changing broadband landscape, and connectivity powerful and intelligent enough to support flexible and profitable high value broadband IP services anywhere, anytime. While SDR is applied for based band (BB) the SR (software radio) is introduced for the whole system baseband, IF and RF. Software radio is the art and science of building radios using software. Given the constraints of today's technology, there is still some RF hardware not involved, but the idea is to get the software as close to the antenna as is feasible. Ultimately, we're turning hardware problems into software problems.

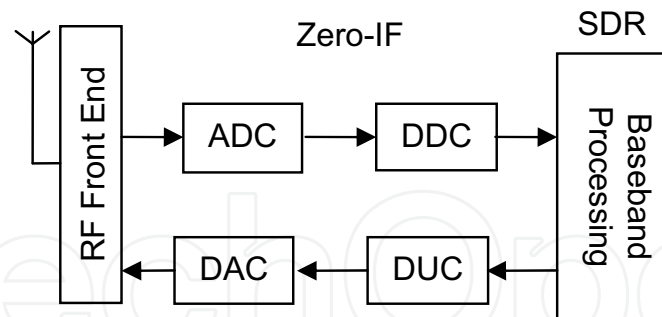

Fig. 3. Block diagram of a generic software Radio

The software radio (SR) contains a number of basic functional blocks. The radio can be split into three basic blocks, namely the front end, the IF section and the base-band section as shown in Figure 3. Each of the sections undertakes different types of functions and therefore is likely to use different circuit technologies.

The front end section uses analogue RF circuitry and it is responsible for receiving and transmitting the signal at the operational frequency, coupling the radio to the antenna or its feeder. It also changes the signal to or from the intermediate frequency (IF). Thus on the receive path the front end serves is connected to the antenna input using matching circuitry to ensure the optimum signal transfer. It then amplifies the signal uses low noise amplifier (LNA) and applies it to a mixer with a signal from a local oscillator to down-convert it to the intermediate frequency.

The IF section performs the digital to analogue conversion and vice versa. It also contains the processing that undertakes what may be thought of as the traditional radio processing elements, including filtering, modulation and demodulation and any other signal processing that may be required. On the receive path the signal enters the DAC where it is digitized and enters the DDC, the Digital Down Converter, where the signal is processed and demodulated to provide the baseband signal for the baseband processor. Similarly on the transmit side the signal arrives from the baseband processor and is modulated onto the carrier and conditioned as required. It is then converted from its digital format to analogue using a digital to analogue converter.

The DDC and DUC require significant levels of processing. This is required to perform all the processing on the actual signals in digital format. This processing must be achieved in real time for the system to be able to operate satisfactorily. As a result the processors are implemented in either stock DSPs or ASICs. In fact to achieve the full programmability and reconfigurability needed for a software defined radio the signal processors may be implemented as FPGAs. In this way the circuit can be totally reconfigured if needed. The final stage of the radio is the baseband processor. It is at this point that the digital data is processed, with protocols being accommodated and the data payload assembled or disassembled from the datastream. Although not as demanding as the DDC and DUC areas, with protocols becoming ever more complicated and demanding, the level of processing is increasing in these areas as well.

4. IEEE 802 Standards for Integration

4.1 802.11u (interworking with external networks)

IEEE 802.11u (IEEE Std 802.11u, 2009) is a proposed amendment to the IEEE 802.11 standard to add features that improve interworking with external networks. The interworking with external networks includes other 802 based networks such as 802.16 and 802.3 and non-802 networks as 3GPP based IMS (IP multimedia subsystem) networks through service provider network (SPN). In this case, interworking refers to MAC layer enhancements that help selection of a network and allow higher layer functionality to provide the overall end to end solution. 802.11u is also to permit an emergency service i.e. E911.

4.2 802.16.4 WirelessHUMAN

WirelessHUMAN is an IEEE802.16 study group standard for wireless high-speed unlicensed metropolitan area networks (IEEE Std 802.16.4, 2009). The objective was to investigate the feasibility of providing High-speed Unlicensed MAN access (focus on UNII bands i.e. 5-6 GHz). This standard specifies the medium access control layer and physical layers of the air interface of interoperable fixed point-to-multipoint broadband wireless access systems. The specification enables transport of data, video, and voice services with quality of service. Physical layers are specified for both licensed and license-exempt bands designated for public network access (see Figure 4). The standard will be based on modifications of the IEEE 802.16 medium access control layer, while the physical layer will be based on the OFDM mechanism of IEEE 802.11a and similar standards.

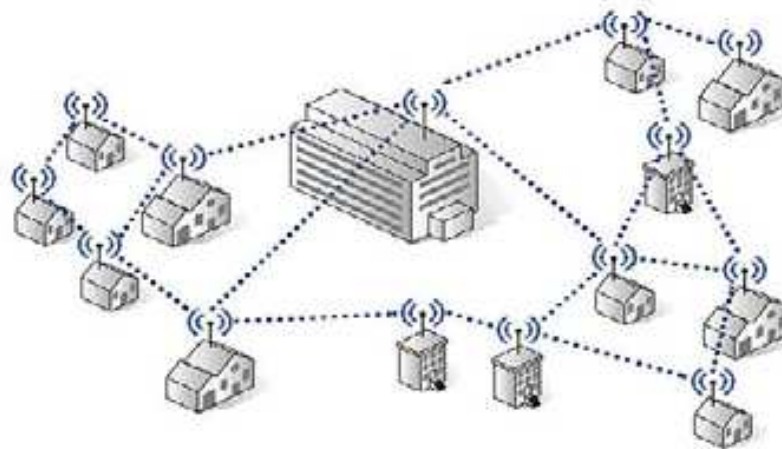

Fig. 4. WirelessHUMAN system architecture.

4.3 IEEE 802.21 Media Independent Handover (MIH)

IEEE 802.21 standard -recently approved at the IEEE-SA (IEEE Std 802.21, 2008)- specifies procedures that facilitate handover decision making, providing link layer state information to MIH users and enabling low latency handovers across multi-technology access networks. Using IEEE 802.21 adds mobility between IEEE802 standards and other cellular networks and creates a single integrated system as shown in Figure 5. IEEE 802.21 provides the glue at

layer 2 (or layer 2.5) to make the any two radio technologies work together as one. Figure 5 illustrates 802.21 services in the protocol stack in a multimode client (e.g., a laptop or handset). 802.21 WG intends to start two amendments study groups for an emergency service i.e. 802.21.1 and multi-radio power Management i.e. 802.21c. IEEE 802.21c amendment shall define mechanisms to reduce power consumption of multi-radio mobile devices on heterogeneous IEEE 802.21 compliant networks.

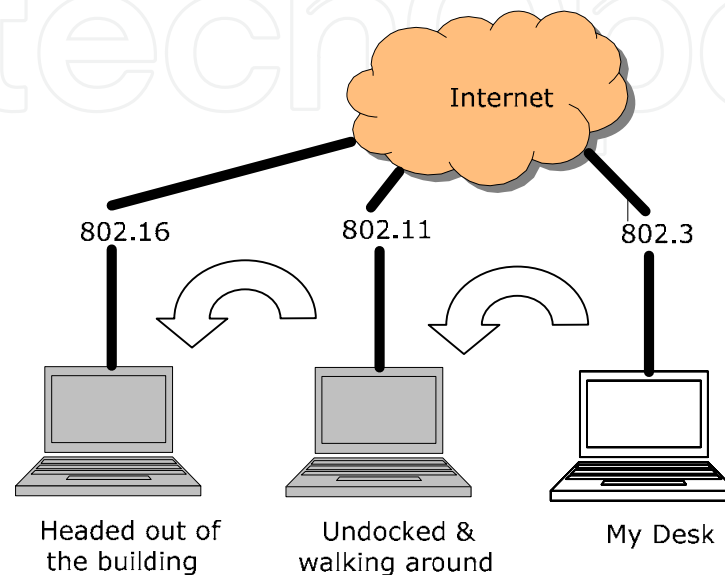

Fig. 5. 802.21 use case for 802.11 and 802.16

5. WiFi/WiMAX Integrated Service

The IEEE 802.11s and IEEE 802.16j groups are specifying standards for WiFi WLAN mesh networks and WiMAX MMR networks, respectively. We truly believe that one strong candidate for the next-generation FMC network architecture consists of optical networks, WiMAX relay networks, and WiFi mesh networks. An example of such architecture is shown in Figure 6.

At the top level, a dense wavelength division multiplexing (DWDM) optical ring forms the core of the metropolitan area network (MAN). At the middle level, WiMAX base stations (BSs) and relay stations (RSs) form a WiMAX MMR network that relays traffic from the lower level to the core network. The bottom level consists of WiFi mesh networks that provide high data rate connections directly to the end users. A transition point between different levels serves as a bridge between networks. Traffic is aggregated and disseminated through the transition points. Especially, the optical switch nodes on the WDM optical ring, which are also portal nodes in WiMAX MMR networks, transfer traffic between wireless networks. Similarly, each WiMAX BS/RS also serves as a portal node in WiFi mesh networks.

IEEE 802.11 WiFi currently has a wide deployment base. The emerging 802.16 broadband access therefore needs to be integrated with existing WiFi technology. There are two types of

integrated WiFi/WiMAX architectures. In the first architecture (Figure 7), WiFi and WiMAX provide complementary wireless access. Dual-mode WiFi/WiMAX users roam between WiFi hotspots and WiMAX base stations. Seamless handoff between WiFi and WiMAX is the main design issue in this integrated environment. In the second scenario, WiMAX is served as a backbone connection for WiFi access points (Figure 8). The wide bandwidth and long transmission range make WiMAX a flexible and cost-effective backbone solution for WiFi access points. Several WiFi access points are connected to the backbone network via a WiMAX base station.

The advantages of multi-hop wireless mesh networks are as follows. First, the connectivity range of the core wireline networks is extended. The concept of multi-hop relay not only extends the communication range of a portal node beyond the single-hop coverage but also relaxes the ties between mesh nodes and the infrastructure. The wireline infrastructure is replaced by wireless backhauls in wireless mesh networks. Second, the deployment of mesh nodes becomes easier and more flexible, and the deployment cost is much lower than the cost of building a wireline connection.

Third, the mesh networks are robust because the networks are interconnected by multiple links. In this section, we introduce the proposed channel-assignment traffic engineering methods for WiFi and WiMAX mesh networks. The differences between WiFi and WiMAX networks are in the Media Access Control (MAC) and the spectrum determine the mechanisms of channel assignment. The allocated spectrum for the WiFi system is completely operated in the license-exempt (unlicensed) band, while most WiMAX systems use the licensed band. As a result, WiMAX and WiFi have different MAC designs. The MAC in WiFi is the contention-based CSMA/CA, while the MAC defined in WiMAX is contention-free. WiMAX BSs schedule time slots to subscriber stations (SSs) (i.e., in the time domain). In addition, with Orthogonal Frequency Division Multiple Access (OFDMA) physical layer (PHY), BSs can allocate a subset of subcarriers to each SS (i.e., in the frequency domain).

Channel assignment can be executed in a centralized or distributed manner. In the centralized channel assignment approach, the channels are allocated by a controller that periodically collects the topology and traffic information from the mesh nodes. Then, the results of channel assignments are disseminated to all mesh nodes for further adjustment.

In the distributed approach, each mesh node decides which channels to use based on the local information, including the topology, channel conditions, and traffic conditions. The distributed approach is simpler and more robust than the centralized approach. Nevertheless, the low channel utilization and lower controlled usage of resources might degrade system performance.

Consequently, distributed approaches are suited to the license-exempt band because the same channel can be used by other systems. Immediate monitoring of variations in channel conditions is more effective than attempting to control the resources. For the licensed spectrum, the centralized approach is recommended simply because it has better performance. In the next two subsections, we present the proposed centralized and distributed channel assignment schemes for WiMAX MMR and WiFi mesh networks.

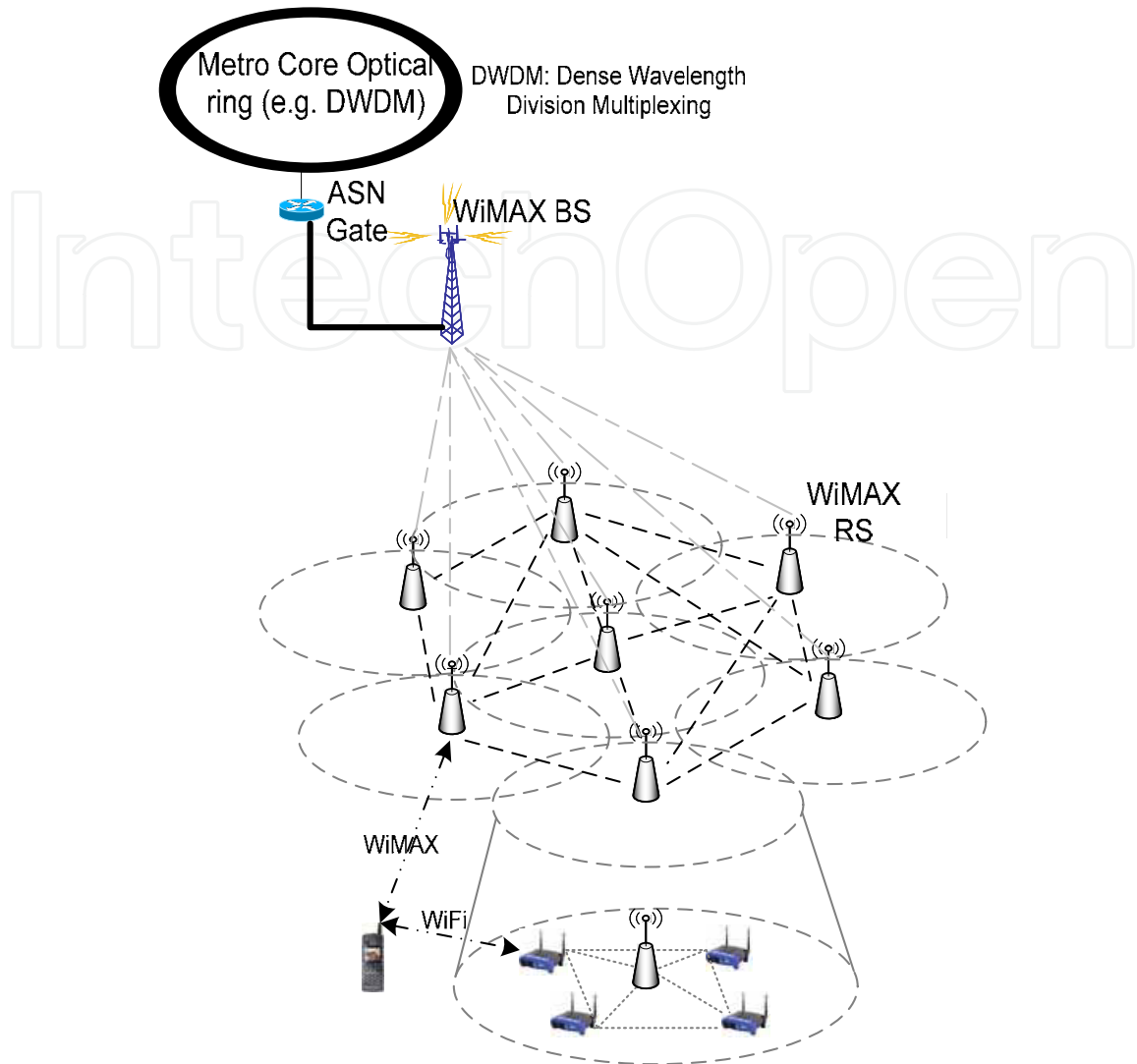

Fig. 6. Heterogeneous network architecture of FMC consisting of optical ring, WiMAX, and WiFi mesh networks.



Fig. 7. Integrated WiMAX/WiFi wireless access.

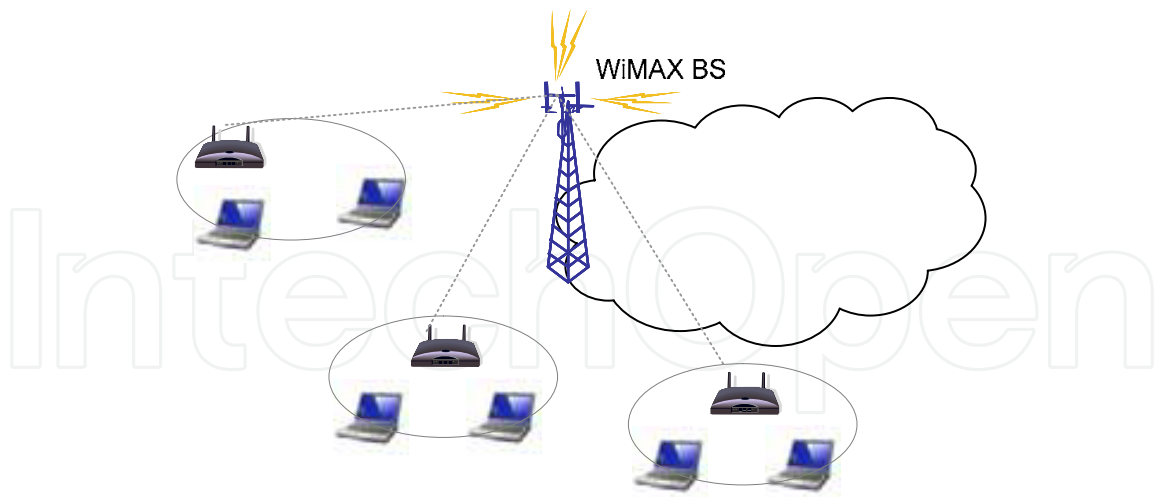

Fig. 8. WiMAX as backbone connection for WiFi access points.

6. WiMAX/WiFi Vertical Handover (VHO)

Together, WiMAX and WiFi are ideal partners for service providers to deliver convenient, affordable mobile broadband Internet services in more places. Both are open IEEE wireless standards built from the ground up for Internet Protocol (IP)-based applications and services. However, both techniques have their own sets of advantages and disadvantages. While IEEE 802.11 has accelerated the network deployment for providing high transmission rate in limited geographical coverage, while IEEE 802.16 offers more flexibility in while maintaining the technology's data rate and transmission range. The limited coverage range of WiFi makes it difficult to meet the future ubiquitous networks need while IEEE 802.16 can provide high speed Internet access in wide area. In this chapter we introduce a new combination of WiMAX and WiFi (called WiWi) (Rashid et al., 2008) to create a complete wireless solution for delivering high speed Internet access to businesses, homes and hotspots. This integration is to avoid the disadvantages of each technique by the other and using the advantages optimally. For example, WiFi may offer a high data rate (up to 500Mb/s is envisaged), but it is power limited due to the use of unlicensed band and are therefore much more confined in coverage, while on the other hand, even though WiMAX is data rate limited (up to 70Mb/s fixed), it can provide extensive coverage much like the cellular systems. Because of that it is instructive to employ both technologies in the laptop/mobile for ubiquitous connection with high data rates (Inayat et al., 2007).

As shown in Figure 9, the WiWi module comprised of physical and MAC layers for both WiMAX and WiFi. For the backhaul the signal is uses WiMAX PHY and MAC protocols, while in the access the signal is uses WiFi PHY and MAC protocols. For the local traffic the signal do not need to pass through the WiMAX protocols. For the Internet traffic the signal need to pass through both WiFi and WiMAX protocols from the access to backhaul and vice versa. The traffic need switch function to recognize the local and Internet traffic and reroute the traffic according to the switch decision, this will be discussed in section 5.1.

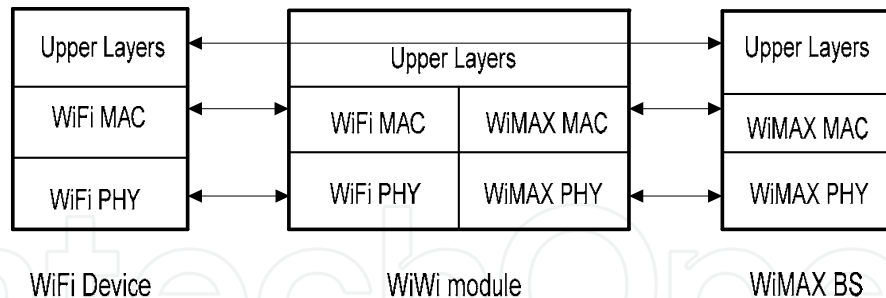

Fig. 9. The WiWi protocol Stack with the WiMAX and WiFi components.

7. WiWi Deployment Models and Scenarios

7.1 WiWi Module Structure

The needs of Internet for rural communities and remote sites using the available broadband access technologies, motivate for deploy new systems design and applications. The widely available, and highly cost-reduced, WiFi hardware meets the cost target for rural applications. However, the current 802.11 MAC protocol has fundamental shortcomings when used over long distances under the power limit enforcement by the local regulators.

The wireless long distance has been studied based on WiFi extensively in WiFiRe (Krishna et al, 2007) and WiLDNet (Robin et al, 2006).

Krishna et al. introduce a new system for rural broadband voice and data access, based on the WiFi PHY, and a new single channel multisector TDM MAC using directional antennas called wireless fidelity - rural extension (WiFiRe) where the concept of wireless communication over WiFi IEEE 802.11b physical layer (PHY) and WiMAX IEEE 802.16 MAC layer is discussed and implemented. As well known, IEEE 802.11b PHY has better availability of low cost chip sets which can operate on unlicensed 2.4GHz frequency band while WiMAX has potential to work over larger distances of 30-40km range. WiFiRe is support maximum of 25Mbps data rate includes both UL and DL and two parallel transmissions by opposite sectors. The design was tested using VOIP simultaneous calls in all STs the capacity was improved about 3.5 times the conventional IEEE 802.11b.

WiLDNet is WiFi-based Long Distance (WiLD) networks with mesh link configuration have the potential to provide connectivity at substantially lower costs than traditional approaches based on IEEE 802.11 with several essential changes to the 802.11 MAC protocol, but continues to rely on standard WiFi network cards. These changes are to overcome the short distance and the random contention-based access of the IEEE802.11. WiLDNet used an adaptive loss recovery mechanism using FEC and bulk acknowledgements.

In this chapter we discuss wireless broadband system using 802.11 in the access and point-to-multipoint (PtMP) WiMAX-based TDD/TDMA technique on each (downlink) carrier at the backhaul in addition to signaling information to control the allocation of upstream traffic channels. The discussion includes the key issues of MAC system and architecture design and performance analysis for the protocol conversion from WiMAX/TDMA frames to WiFi/contention-based packets and vice versa, and the delay/jitter associated.

The Broadband Access PtMP System provides wireless broadband access to the operator service nodes (POPs) from remote customer locations. As shown in Figure 10, each remote location is served by a peripheral station that is able to offer a variety of service interfaces to end users. The AP has a two-way full duplex radio link to the BS, which is connected to the core network with different types of trunk interfaces. Subscribers can have access to the full range of services by means of various standardized user-network interfaces (i.e. Ethernet, WiFi, dial-up, etc). The BS provides also standard core network interfaces, to transparently connect subscribers to the appropriate service node. The system allows services to be provided to a number of subscribers, ranging from a few tens to many hundreds of users in the same area, and over a wide range of distances (depending on the RF frequency used). In this section we will concentrate on the design of the backhaul network interface which is combines of WiFi and WiMAX.

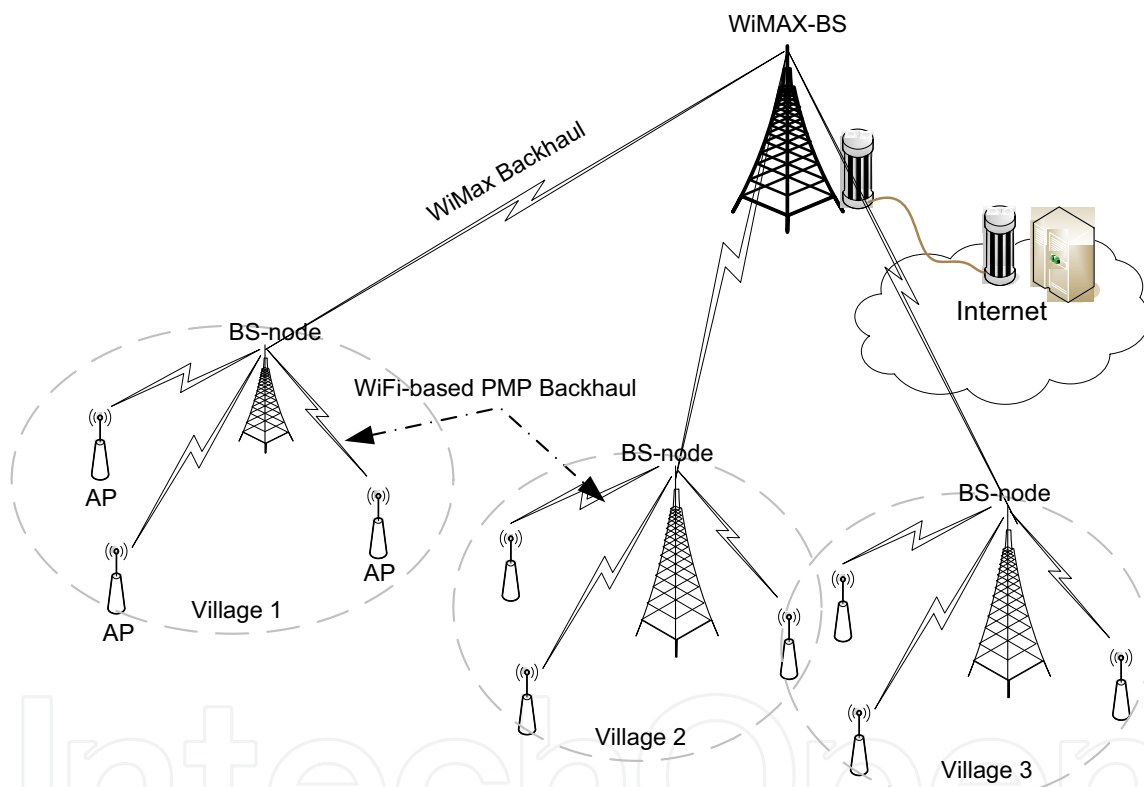

Fig. 10. wireless broadband network architecture

The system will allow a point-to-multipoint (PtMP) topology to cover a wide highly populated metropolitan area collecting various kinds of services. Moreover, with the PtMP scenario each cell, served by a central BS, can be split into a variable number of sectors using directional antenna, thus allowing efficient reuse of allocated spectrum and increasing system capacity.

Each AP is equipped with a high gain directional antenna in line or non-line of sight with the BS. It receives the multiplexed traffic channels and de-multiplexes the information directed to the user served by the AP (Koutsakis and Paterakis, 2005). In its turn it transmits back to the BS, on a separate frequency (uplink), traffic and signaling information. Uplink transmission is slot based TDMA that is each AP is assigned a time slot to transmit in the 802.16d frame. One BS can support up to 150 Mbps of traffic payload per direction per sector (Su et al., 2003). Figure 11 shows the protocol architecture for the proposed network. The WiMAX BS is associated with gateway which provides multi interfaces to the internet (FDDI, DSL, 3G, etc) (Tang, 2004). As shown in the figure, the BS is IEEE802.16 layer-2 device, PHY layer based OFDM modulation baseband and MAC based fixed-WiMAX/TDMA techniques to provide time slot sharing between the APs. The APs are also WiWi-based layer-2 devices, has two interfaces, the backhaul interface connect with the BS through the backhaul and interface to the end-user.

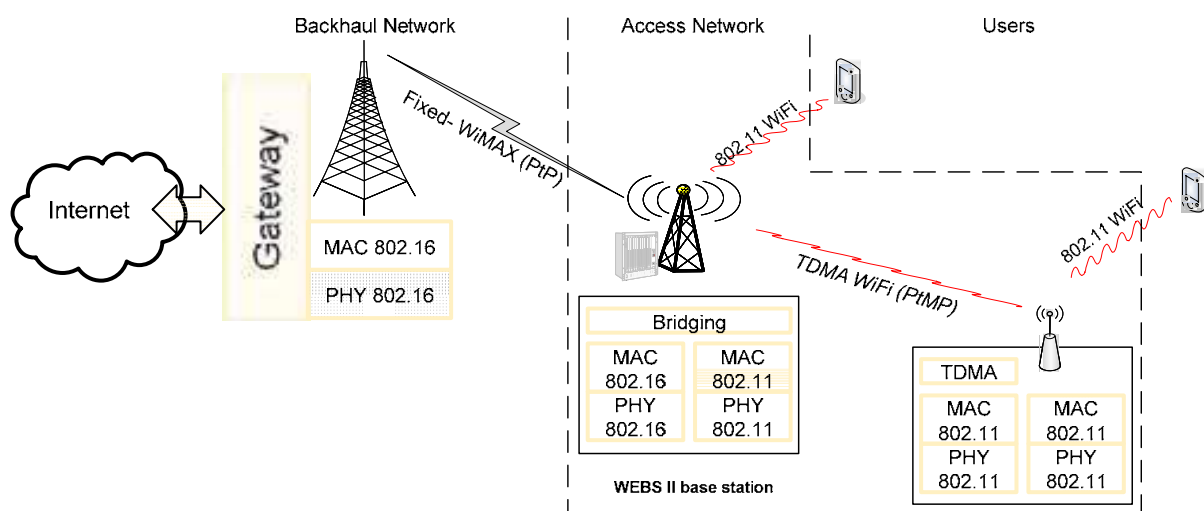

Fig. 11. wireless broadband system description and protocol Architecture

The access point (AP) need protocol converter/bridge to convey the data from the access to the backhaul. Figure 12 shows the proposed protocol converter (802.16/11 bridge), which is comprises of traffic classifier, scheduler and protocol encapsulation/de-encapsulation. Local traffic is the traffic from/to the access network under the same local community also called intra access point traffic. The external traffic is the traffic from/to Internet. First the traffic is classified; then the traffic is scheduled in to two queues based on the traffic types. A simple scheduler can be used here i.e. round robin or FIFO. Finally, the Internet traffic needs protocol encapsulation due to the different air interfaces. WiFi packets are encapsulated in the WiMAX frame for the upload link and vice versa for the download traffic.

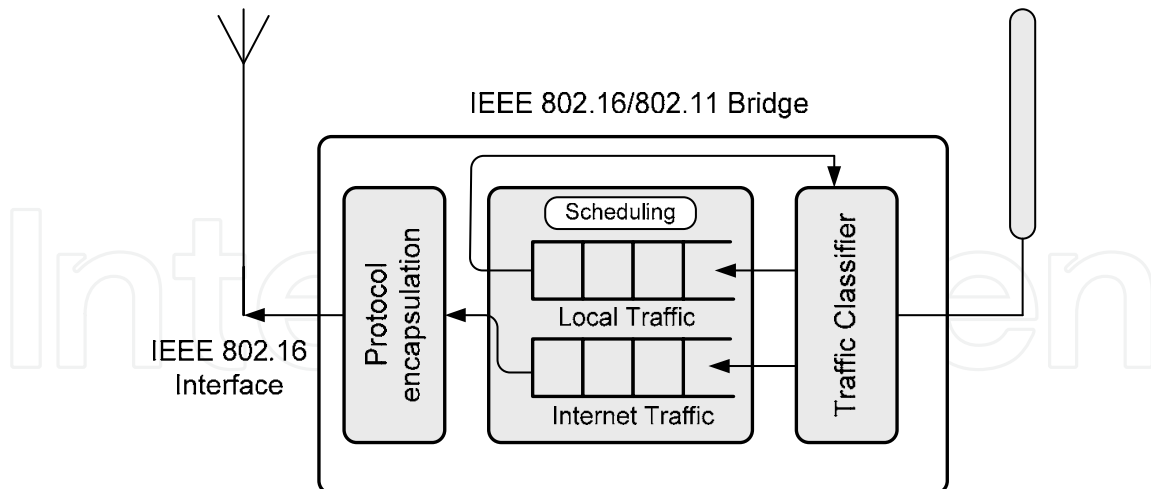

Fig. 12. the proposed protocol converter/bridge between IEEE 802.16/802.11

7.2 WiWi Mobile Multihop Module

In this section, we incorporate the WiWi module at the mobile station site. Where WiWi module works as a relay module (a.k.a. mobile relay node). The mobile relay node (WiWi-based device) receives signal from the WiMAX network (i.e. BS) and convert it to WiFi signal and relay this signal to the WiFi-based devices (i.e. laptop). The scope of this section is using the WiWi module to increase the WiFi-based devices range when the user moves out of the WiFi coverage. The main advantage of the WiWi module is the WiFi-based devices are no longer need to have WiMAX SIM (Subscriber Identification module) module. Since, the WiMAX connection to the operator is not free, so equipped all the devices with WiMAX SIM module is economically not feasible. However, since WiFi is unlicensed and free access, so the better is to equip one device (WiMAX mobile) with WiWi module and relay the signal to the other WiFi-based devices (laptop, PDA, etc). This scenario can be in open/public mode which means the WiWi module will relay the signal to all other devices around; similar to the mobile ad-hoc network (MANET) architecture. Or can be in close/private mode which is offer services to its own devices using specific connection permission and identification. This will allow Internet connection continuity for WiFi-based devices out of WiFi service provider/operators hotspots coverage for free and the cost will be paid to the WiWi-based devices battery life.

In Figure 13, there are two possible scenarios; (a) the WiFi-based devices (i.e. laptop) within WiWi and WiFi networks coverage and (b) the WiFi-based devices out of WiFi network coverage. In the scenario (b) the process is straightforward in which the WiFi-based device sees only one network connection, which is provided by WiWi module. Directly the device will start network entry process to join WiMAX network using WiWi module installed at the WiWi-based device (i.e. WiMAX mobile). On the other hand, the scenario in Figure 13(a), there is two networks available, WiMAX (using WiWi module) and WiFi network. The WiFi-based devices should select only one of them to access the Internet based on the received signal strength indicator (RSSI) message received from the AP/BS. In this scenario using the conventional handover for network selection based on RSSI message is problematic, because WiFi-based devices sense two WiFi signals, the first signal from WiWi-based device and the other from WiFi access point (AP) (Li-Chun et al., 2007).

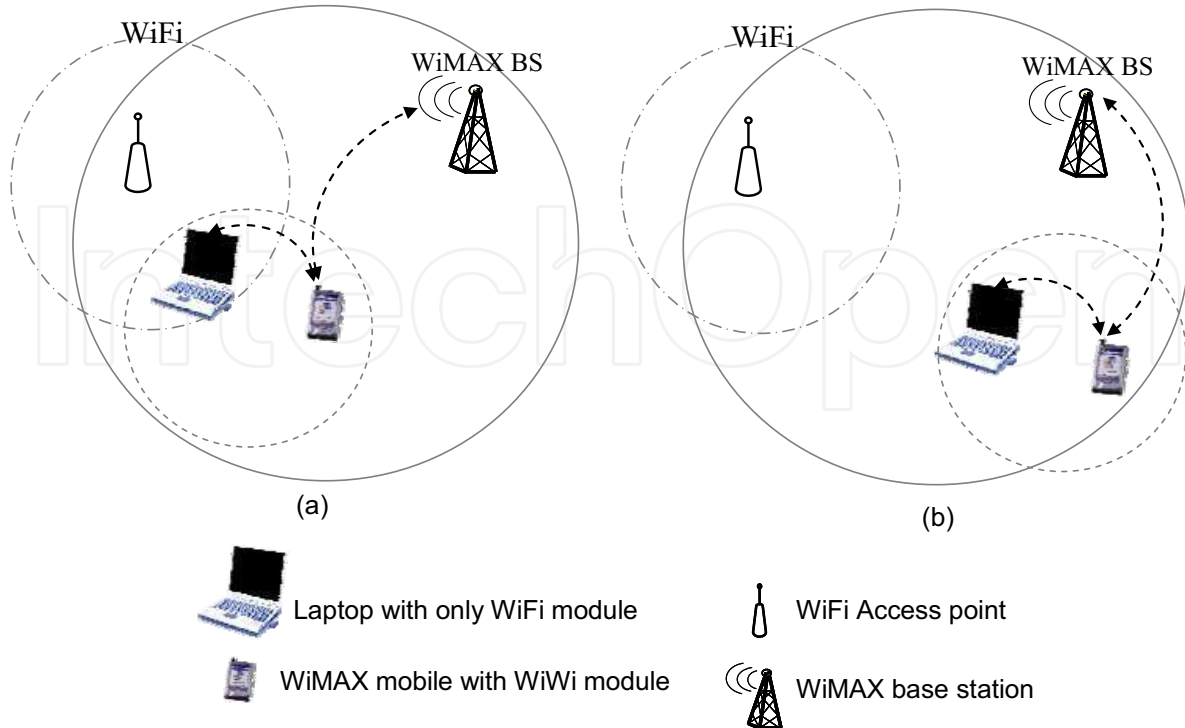

Fig. 13. WiMAX and WiFi coverage in indoor and outdoor (a) the laptop in the WiFi coverage (b) laptop is out of WiFi coverage.

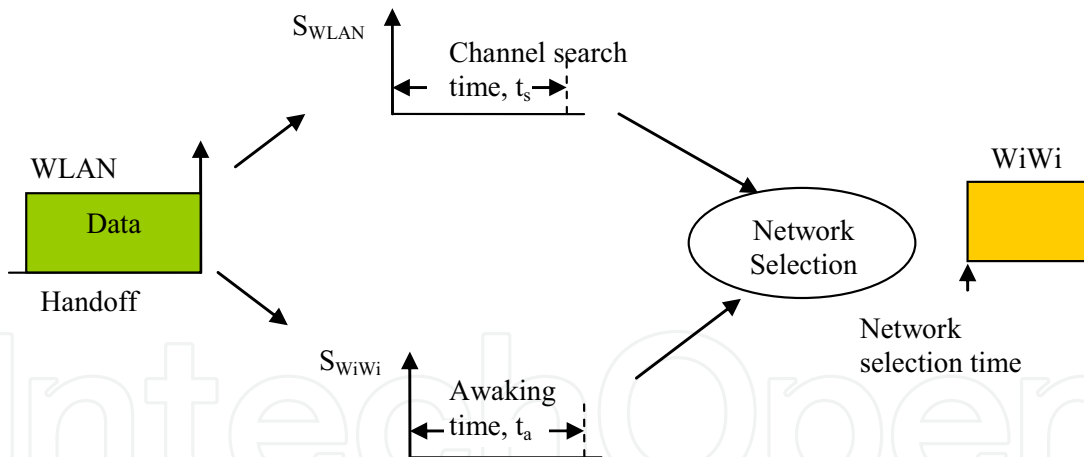

Fig. 14. System model for jointly vertical handoff (WiFi to WiWi).

The difference between this scenario and the conventional scenario is that the decision criteria are not the same due to the difference in the technology, in which the WiWi is virtual WiFi technology which only the interface is the WiFi, which is relay (regenerate) the WiMAX signal to WiFi format. So, the WiFi-based device by using the conventional handover/roaming protocols will lead to wrong decision and results of non-optimized throughput. Usually, the throughput of the WiWi network is lower than WiFi throughput, due to the degradation results from multihop relay in the WiWi network (Rashid et al., 2008). RSSI is one of the important criteria for AP selection and handover. So, in WiWi case the RSSI value alone is not sufficient to be decision criteria for handover. For example in

close/private mode, all WiFi-based devices are closer to WiWi module than the AP. So, the RSSI from WiWi signal is usually greater than the signal from AP (WiFi network) signal. This is shown in Figure 14. In this chapter we propose new algorithm for the network selection based the total throughput on addition to RSSI criteria.

Figure 15 shows the proposed handover decision based on RSSI and throughput. The total throughput $\phi(\lambda_{WiWi})$ for WiWi network is calculated based on WiMAX throughput $\phi(\lambda_{WiMAX})$ and the effect of vertical handover within the WiWi module. This is done as follows:

$$\phi(\lambda_{WiWi}) = \sum_n \phi(\lambda_{WiMAX} - c_{WiMAX} / \sqrt{n} - \psi) \quad (1)$$

where c_{WiMAX} / \sqrt{n} is the degradation of throughput due to multihop relay (Zhang et al. 2003). c_{WiMAX} is the WiMAX capacity and n is the number of hops (i.e. in WiWi, $n = 2$). ψ is the total throughput loss due to protocol converter and interference between WiFi and WiMAX. Figure 16 shows the flow of the messages for connecting WiFi devices the WiWi network. Here we assume the WiWi in the closed mode so that there are no other nodes sharing the channel with the WiFi device. The $\phi(\lambda_{WiMAX})$ throughput depends on the WiMAX channel bandwidth (i.e. 1.25-20MHz) and total number of tones (256 for fixed and 1024 for mobile) and channel quality (Su Yi et al., 2003).

IntechOpen



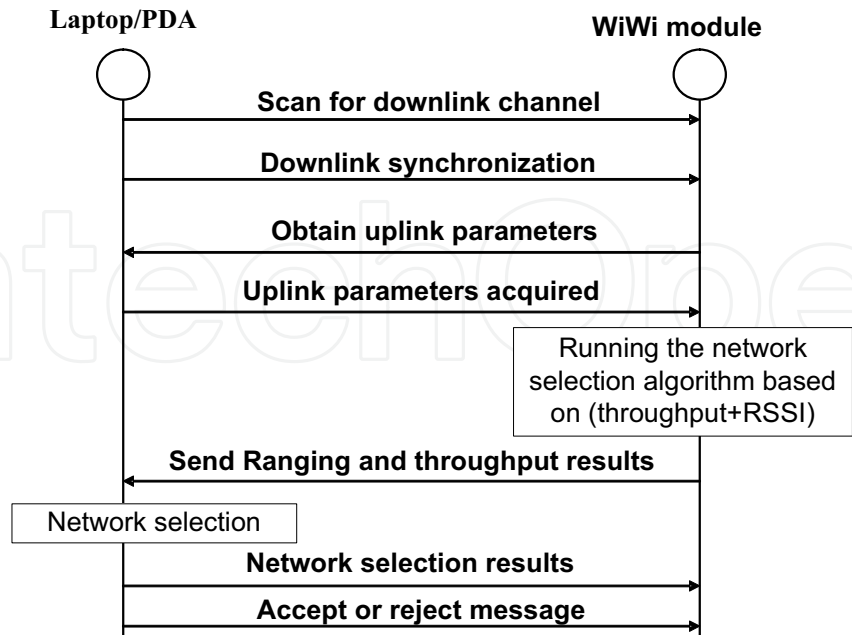

Fig. 16. Proposed signalling process in the WLAN to WiMAX handoff scenario

Figure 17 shows the time delay WiMAX and WiFi internetworking, which shows the delay time for the proposed method is less than using MIH and MIS.

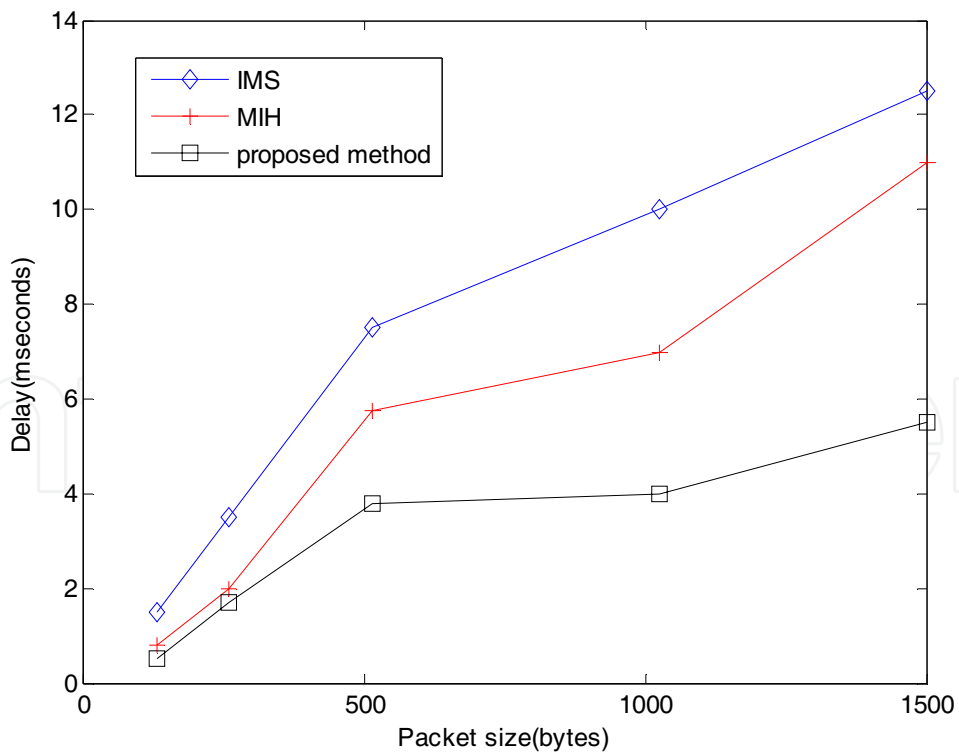

Fig. 17. Delay for the proposed vertical handover using WiWi module delay compared with MIH and IMS.

8. Conclusions

In this chapter the integration between WiFi and WiMAX networks is discussed. Some of potential technologies for integration include IEEE 802.11u (IEN), IEEE 802.21 (MIH) and IEEE 802.16.4 (WirelessHUMAN) are also presented. A new module called WiWi is proposed for integration and two scenarios are discussed. The first scenario is the infrastructure scenario which WiWi module allocated in the access point (AP). The second scenario is the mobile multihop scenario which the WiWi module allocated at the mobile station. Finally, a new vertical handover algorithm for WiWi network is proposed. The objective of the new vertical handover is to solve the virtual WiFi problem that introduced by the WiWi module. The proposed algorithm is performed at a new logical adaptation layer which allocated above the MAC layer. The results of the proposed algorithm shows less overhead in the protocol conversion compared with the other conventional convergence protocols IP multimedia subsystem (IMS) and media independent handover (MIH).

9. References

- 3GPP TS 23.206 (currently Release 7 draft), "Voice Call Continuity between CS and IMS."
- Behmann F., (2005) "Impact of Wireless (Wi-Fi, WiMAX) on 3G and Next Generation: An Initial Assessment" *Electro Information Technology*, 2005 IEEE International pp: 1-6.
- Berlemann, L., Hoymann, C., Hiertz, G.R., Mangold, S. (2006) "Coexistence and Interworking of IEEE 802.16 and IEEE 802.11(e) ", *IEEE 63rd Vehicular Technology Conference*, 2006. (VTC 2006-Spring). Volume 1, Page(s):27 - 31.
- Dhawan S., (2007) "Analogy of Promising Wireless Technologies on Different Frequencies: Bluetooth, WiFi, and WiMAX" *Wireless Broadband and Ultra Wideband Communications*, 2007 (AusWireless2007). The 2nd International Conference on pp: 14 - 17.
- F. Cacace and L. Vollerio, (2006) "Managing Mobility and Adaptation in Upcoming 802.21 Enabled Devices," *Proc. 4th Int'l. Wksp. Wireless Mobile Apps. and Svcs. on WLAN Hotspots*, Los Angeles, CA, Sept. 29-29, pp. 1-10.
- Gaitan O.S., Martins P., Tohme S., Demerjian J., (2005) "SIP Embedded Attribute Certificates for Service Mobility in Heterogeneous Multi-Operator Wireless Networks" *Vehicular Technology Conference*, 2007 (VTC2007), pp2000 - 2004.
- IEEE Std 802.11u, (2009) "Information Technology – Telecommunications and Information Exchange between Systems – Local And Metropolitan Area Networks – Specific Requirements – Part 11: Wireless LAN Medium Access Control (MAC) and Physical Layer (PHY) Specifications: Wireless Interworking with External Networks."
- IEEE Std 802.16.4, (2008), "IEEE 802.21: Media Independent Handover Services", Approved in Nov. 2008.
- IEEE Std 802.16.4, (2009), "IEEE 802.16 Task Group 4 (WirelessHUMAN™ Task Group)" wirelessman.org/tg4/, accessed on March 2009.
- IEEE Std 802.16g, (2009) "Information Technology – Telecommunications and Information Exchange between system- Local and Metropolitan Area Networks – Specific Requirements – Part 16: Air Interface for Fixed Broadband Wireless Access Systems: Management Plane Procedures and Services."

- Inayat, R, Aibara, R, Nishimura, K, (2007) "A seamless handoff for dual-interfaced mobile devices in hybrid wireless access networks", *Advanced Information Networking and Applications (AINA2007)*, Volume: 1, pp 373-378.
- Inayat, R, Aibara, R, Nishimura, K, (2007) "A seamless handoff for dual-interfaced mobile devices in hybrid wireless access networks", *Advanced Information Networking and Applications, AINA 2007*, Volume: 1, Pages: 373-378.
- Jong-Ok Kim, Shigeno H., Yamaguchi A., Obana, S., (2004) "Airtime-based Link Aggregation at the Co-existence of WiMAX and WiFi", *Personal, Indoor and Mobile communication journal*, pp. 51-58.
- K. Sundaresan, H. Hsieh, and R. Sivakumar (2004) "IEEE 802.11 over Multihop Wireless Networks: Problems and New Perspectives" *Ad Hoc Networks Journal*.
- Koutsakis, P., and Paterakis (2005), "On multiple traffic type integration over wireless TDMA channels with adjustable request bandwidth", *International Journal of Wireless Information Networks* 7, PP 55-68.
- Krishna Paul, Anitha Varghese, Sridhar Iyer, Bhaskar Ramamurthi, Anurag Kumar, (2007) "WiFiRe: Rural Area Broadband Access using the WiFi PHY and a Multisector TDD MAC", *IEEE Communications Magazine*, special issue on Telecommunications in Emerging Economies, Vol 8 (10), pp-23-30.
- Lampropoulos G, Salkintzis K, Passas N, (2007) "Media-independent handover for seamless service provision in heterogeneous networks" *IEEE Communications Magazine*, V(46), Issue: 1 pp 64-71.
- Li-Chun Wang, Anderson Chen, Hung-Hsi Chen, (2007) "Network Selection with Joint Vertical and Horizontal Handoff in Heterogeneous WLAN and Mobile WiMAX Systems", *Vehicular Technology Conference, 2007 (VTC2007)*, pp 794-798.
- Man Cheuk Ng Vijayaraghavan, M. Dave, N. Arvind Raghavan, G. Hicks, J. (2007), "From WiFi to WiMAX: Techniques for High-Level IP Reuse across Different OFDM Protocols" *5th IEEE/ACM International Conference on Formal Methods and Models for Codesign, 2007 (MEMOCODE 2007)* page(s): 71-80.
- MIMOS (2009), www.mimos.my, accessed in Dec 2009.
- Niyato D., Hossain E., (2004) "Wireless Broadband Access: WiMAX and Beyond - Integration of WiMAX and WiFi: Optimal Pricing for Bandwidth Sharing" *IEEE Communications Magazine*, pp: 140-146, V (45), Issue 5.
- Pahlavan K, Krishnamurthy P, Hatami A; Ylianttila M, Makela J.P, Pichna R, Vallstron J, (2007) "Handoff in Hybrid Mobile Data Networks", *Mobile and Wireless Communications Summit*, V (7), Issue: 2, pp 34-47.
- Q. Zhang et al. (2003), "Efficient Mobility Management for Vertical Handover between WWAN and WLAN," *IEEE Commun. Mag.*, Vol. 41 (11), pp. 102-108
- Rabin Patra, Sergiu Nedeveschi, Sonesh Surana, Anmol Sheth (2008) "WiLDNet: Design and Implementation of High Performance WiFi Based Long Distance Networks", *NSDI*, pp 86-91.
- Rabin Patra, Sergiu Nedeveschi, Sonesh Surana, Anmol Sheth, Lakshminarayanan Subramanian, Eric Brewer, (2007) "WiLDNet: Design and Implementation of High Performance WiFi Based Long Distance Networks" *26th IEEE International Conference on Computer Communications (INFOCOM 2007)*, Pp:312 - 320.

- Rashid A. Saeed, Hafizal Mohamad, B.M. Ali, (2009) "Vertical Handover Evaluation for WiWi Network based on Overall Throughput", accepted in Praise Worthy Prize, Italy.
- S. Xu and T. Saadawi (2001) "Does the IEEE 802.11 MAC Protocol Work Well in Multihop Wireless Ad hoc Networks" IEEE Communications Magazine, 39(6):130-137.
- Su Yi, Yong Pei, Shivkumar K. (2003) "On the capacity improvement of ad hoc wireless networks using directional antennas" International Symposium on MobiHoc, pp 108-116.
- Surducan, E. Iancu, D. Surducan, V. Glossner, J. (2007) "Miniature multiband antennas for hand held WIMAX and WiFi application" Electromagnetics in Advanced Applications, (ICEAA 2007), pp 13-16.
- Tang C., (2004) "Evolving to wireless and wireline convergence - an overview of IMS" Wireless and Optical Communications, 2005. (WOCC2005), pp 27-29.
- V. Gunasekaran and C. Harmantzis, (2005) "Affordable Infrastructure for Deploying WiMAX Systems: Mesh v. Non Mesh" In IEEE Vehicular Technology Conference (VTC), Stockholm, Sweden.
- Zlydareva, O. Sacchi, C. (2008) "Multi-Standard WIMAX/UMTS System Framework SDR", IEEE Aerospace Conference, page(s): 1-13.

IntechOpen

IntechOpen

IntechOpen



WiMAX New Developments

Edited by Upena D Dalal and Y P Kosta

ISBN 978-953-7619-53-4

Hard cover, 442 pages

Publisher InTech

Published online 01, December, 2009

Published in print edition December, 2009

WiMAX (Worldwide Interoperability for Microwave Access) is a wireless broadband access network named by industry group called the WiMAX forum formed in June 2001. It is Wireless MAN with IEEE 802.16 family standards. Loosely, WiMAX is a standardized wireless version of Ethernet that enables the last mile, intended primarily as an alternative to wire technologies (such as Cable Modems, DSL and T1/E1 links) to provide broadband access to customer premises. Mission of the WiMAX forum is to promote and certify compatibility and interoperability of broadband wireless products. This book touches most of the above issues in form of 22 individuals' papers containing research work in WiMAX domain in particular. WiMAX has two important standards/usage models: a fixed usage model IEEE 802.16-2004 for Fixed Wireless Broadband Access (FWBA) and a portable usage model IEEE 802.16e-2005, which is mainly concentrated on Mobile Wireless Broadband Access (MWBA). Both are released as standards and amendments are available in form of drafts. Higher data rate transmissions (@ 100 Mbps) are achieved in IEEE 802.16-2004 WiMAX through LOS communications which incorporate a stationary transmitter and receiver but IEEE 802.16e supporting NLOS communication is much complicated and little less bit rate is achieved. 2-11 GHz licensed band is the range of frequencies with TDD and FDD supports. The book will provide a wide horizon to visualize the WiMAX technology and its developments leading towards 4G systems. It will provide a good platform to the researchers with clues to the innovative ideas in WiMAX domain. I wish all the best to the authors and readers of this book in their successful research of WiMAX technology.

How to reference

In order to correctly reference this scholarly work, feel free to copy and paste the following:

Rashid A. Saeed, Amran Naemat, Azrin Aris and Mat Kamil Awang (2009). WiMAX-WiFi Synergy for Next Generation Heterogynous Network, WIMAX New Developments, Upena D Dalal and Y P Kosta (Ed.), ISBN: 978-953-7619-53-4, InTech, Available from: <http://www.intechopen.com/books/wimax-new-developments/wimax-wifi-synergy-for-next-generation-heterogynous-network>

INTECH
open science | open minds

InTech Europe

University Campus STeP Ri
Slavka Krautzeka 83/A
51000 Rijeka, Croatia
Phone: +385 (51) 770 447

InTech China

Unit 405, Office Block, Hotel Equatorial Shanghai
No.65, Yan An Road (West), Shanghai, 200040, China
中国上海市延安西路65号上海国际贵都大饭店办公楼405单元
Phone: +86-21-62489820

www.intechopen.com

Fax: +385 (51) 686 166
www.intechopen.com

Fax: +86-21-62489821

IntechOpen

IntechOpen

© 2009 The Author(s). Licensee IntechOpen. This chapter is distributed under the terms of the [Creative Commons Attribution-NonCommercial-ShareAlike-3.0 License](https://creativecommons.org/licenses/by-nc-sa/3.0/), which permits use, distribution and reproduction for non-commercial purposes, provided the original is properly cited and derivative works building on this content are distributed under the same license.

IntechOpen

IntechOpen