

We are IntechOpen, the world's leading publisher of Open Access books Built by scientists, for scientists

4,500

Open access books available

118,000

International authors and editors

130M

Downloads

Our authors are among the

154

Countries delivered to

TOP 1%

most cited scientists

12.2%

Contributors from top 500 universities



WEB OF SCIENCE™

Selection of our books indexed in the Book Citation Index
in Web of Science™ Core Collection (BKCI)

Interested in publishing with us?
Contact book.department@intechopen.com

Numbers displayed above are based on latest data collected.
For more information visit www.intechopen.com



How Do Acoustic Materials Work?

Alice Elizabeth González

Abstract

Acoustic quality of closed spaces is an increasing concern all around the world, since noise pollution is one of the main nowadays pollutants, but also one of the less considered when building designing and construction. In 2011, the World Health Organization stated that noise pollution should be treated as a public health concern: about 1 million years of human healthy life are lost yearly because of the environmental noise pollution, emphasizing on traffic noise in the cities. There are some physics phenomena that are the rule of thumb for room acoustic projects. This chapter introduces the main concepts about them: sound absorption, insulation, and diffusion. Their principles, main implementation, and computing are presented for each one.

Keywords: acoustic materials, sound absorption, sound insulation, sound diffusion

1. Introduction

1.1 Acoustic quality

Under the term “acoustic quality,” a set of characteristics (as sound pressure levels, spectral composition, and duration of the sounds perceived) is integrated, as well as others related to the space itself—for example, its reverberation time—which allow to qualify how valuable this space is regarding its aptitudes or potentialities for the desired use.

One place can have good acoustic quality for a certain use but not for another. For example, the high reverberation time of Catholic churches is part of the characteristics of the space of meditation that is desired to be generated there and is suitable for interpreting/listening to sacred music; however, it conspires against the understanding of the spoken word.

1.2 Noise control and acoustic project

The concepts of acoustic quality and noise control are often closely related. Noise control refers to a set of methods, techniques, and technologies that allow obtaining acceptable noise levels in a certain place, according to economic and operational considerations [1].

Noise control does not necessarily imply reduction of noise emissions; it refers to making acceptable the sound level in immission (i.e., the signal that reaches the receiver). To know if it is, some objectives and valid criteria must be selected and applied to compare with, in order to answer the question of “acceptable for what” or “for whom”. There are different ways to attack a wide range of cases in order to achieve the desired acoustic quality at the receiver.

The acoustic project of enclosures involves the selection of materials to determine the type and quality of walls, surfaces, etc. so that a certain location is apt for one use. It involves avoiding an undesired level of incidence of external noise and making the internal reverberation characteristics adequate for the desired use. To achieve the acoustic quality objectives, working harmonically on insulation, absorption, and diffusion of sound is needed.

1.3 Sound insulation and absorption

When a sound wave reaches one surface, part of its energy (incident energy E_i) is reflected toward the same half space from where it comes (reflected energy E_r). According to Snell's law, the angles of E_i and E_r with the surface of incidence are equal. When the propagation media changes from media 1 to media 2, the incident and refracted angles should fulfill next relation (also according to Snell's law):

$$n_1 \sin \theta_1 = n_2 \sin \theta_2 \quad (1)$$

where n_1 and n_2 are the relations with sound speed c_1 and c_2 in the considered media and they fulfill the relation (c_0 is the reference sound speed in air):

$$c_0 = n_1 c_1 = n_2 c_2 \quad (2)$$

The non-reflected energy is usually expressed as the sum of two terms: transmitted energy E_t and absorbed energy E_a . The first one is the part of the energy that passes through the surface or wall and generates another acoustic wave at the other side of the wall; the second one is the part of the incident energy that is dissipated at the surface (**Figure 1**).

Let α be the absorption coefficient ($\alpha = E_a/E_i$) and τ the transmission coefficient ($\tau = E_t/E_i$). The part of the incident energy that is not reflected should accomplish:

$$E_i - E_r = \alpha E_i + \tau E_i = (\alpha + \tau) E_i \quad (3)$$

The more energy is absorbed, the less energy should be transmitted and vice versa. In other words, a good insulating material is bad for acoustic absorption, as a high value of α is related to a low value of τ . The more porous is a material, the less it insulates; the more resistance to the flow of air a material presents, the better insulation performance it has. Intuitively (but not strictly), the heavier the material is, the better insulation performance is expected.

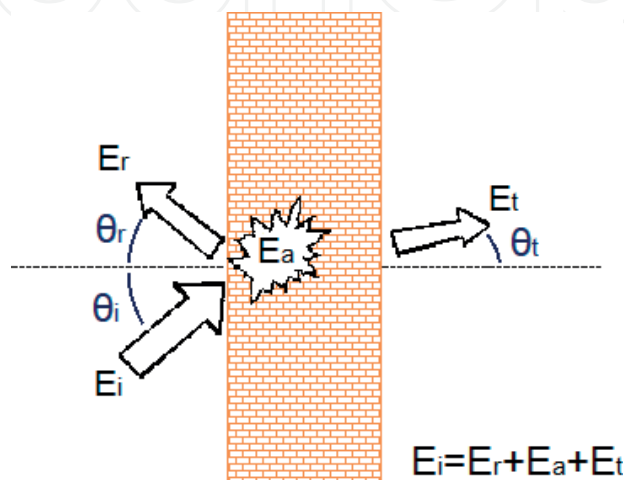

Figure 1.
Possible destinations of the acoustic energy that reaches a surface.

When a good insulation is reached, a great amount of the incident energy is retained in the emission source room. If the room has low sound absorption, the sound pressure levels inside could eventually increase. To avoid this result, a suitable absorption treatment should be done on the surfaces of the room in order to reduce the reflections (the reverberation).

The so-called absorbed energy is dissipated in the surface on which the sound waves impinge. It is related to the characteristics of the surface material, both in terms of its internal structure and its elasticity and texture: the more elastic or rough the surface is, the more energy will be absorbed, as it will deform more or the sound path will be increased the more through multiple reflections. The dissipation that occurs in the pores and the microstructure of the material will be higher, and less energy will be reflected toward the room. Anyway, the amount of energy involved in these phenomena is very little to cause a perceptible change of the surface temperature or shape.

However, if acoustic energy is emitted in a low absorption room, the sound pressure levels inside can be increased by successive sound reflections. Consequently, the insulation required to protect the contiguous rooms against sound transmission may be higher.

Regarding what happens at the emission room, the acoustic energy distribution is strongly related to its acoustic quality. If a homogeneous distribution is achieved, every people at the room will have the same sound quality experience. In fact, there are some common acoustic defects that can occur, for example, stationary waves due to normal modes. To work on the acoustic energy distribution into a room, attention on sound diffusion is needed. Sound diffusion materials are those that contribute to scatter sound waves in different directions to reach a homogeneous (or diffuse) sound field. The main property of sound diffusion materials is their surface design: they have irregular surfaces with cavities and protuberances whose dimensions are calculated according to the sound frequencies they are expected to correct.

2. Sound absorption

The acoustic absorption is the phenomenon by which the acoustic energy is transformed into another type of energy: thermal, mechanical, or deformation energy. The acoustic absorption is, then, an energy dissipation phenomenon.

The acoustic absorption coefficient α of a surface is defined as the relation between the acoustic energy that it can absorb and the incident energy that affects it. It is dimensionless:

$$\alpha = \frac{E_a}{E_i} \quad (4)$$

Then, the absorbed energy turns out to be $E_a = \alpha E_i$.

There are three families of absorbent materials, which fulfill their function according to different phenomena: porous/fibrous materials, membrane absorbers, and resonators. Each one has its best performance in different frequency ranges, as shown in **Figure 2**.

2.1 Porous or fibrous sound absorbers

Absorbent materials are usually elastic, not very dense and permeable; in fact, they are formed mostly by air. These are soft or fibrous materials containing fine

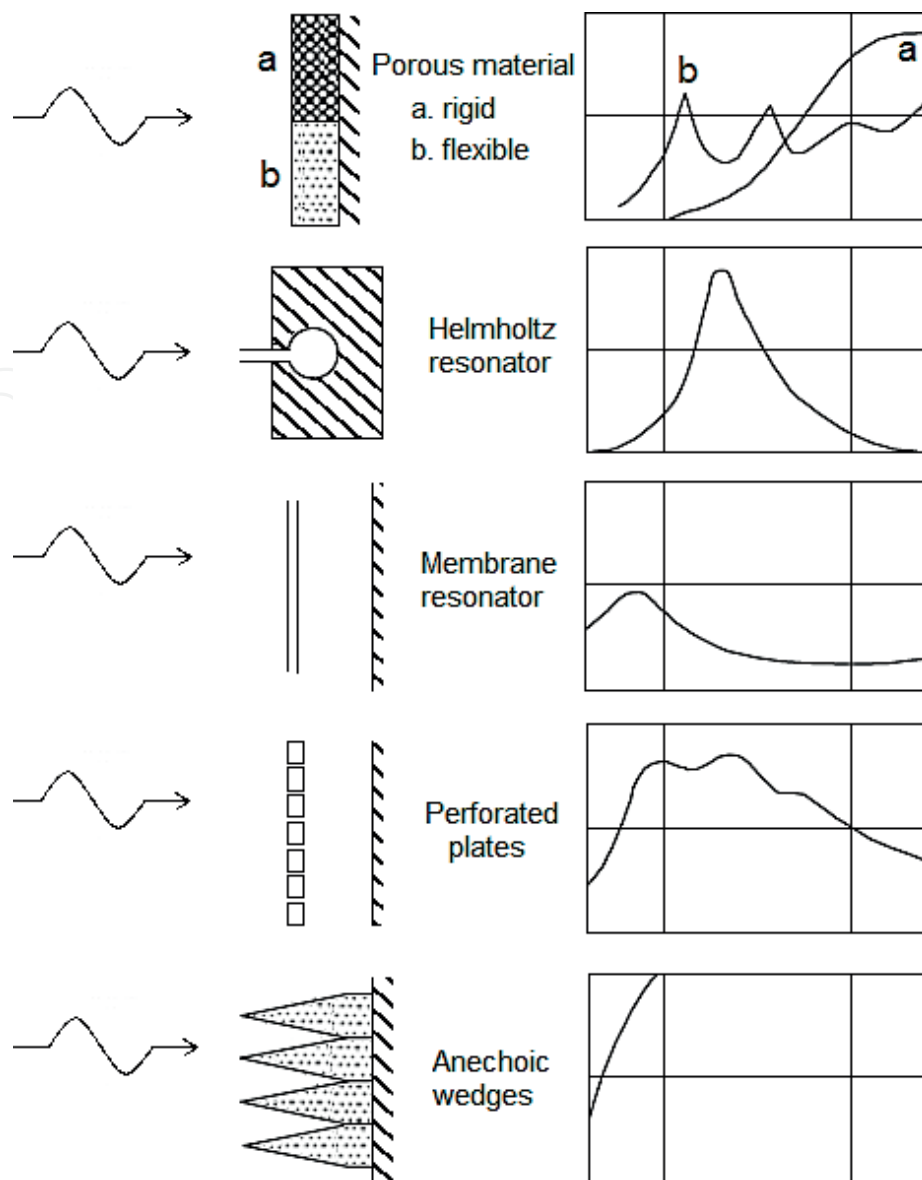

Figure 2.
Types of acoustic absorbers and their performance curves. Adapted from [2].

channels interconnected with each other. Although they are considered the absorbent materials par excellence, they are not the only ones. They can absorb acoustic energy through two mechanisms:

- When they are soft materials, they absorb due to the deformation that occurs when the sound wave hits them.
- When they are porous materials, they absorb by the vibration of the air contained in its pores, which loses energy by friction against their edges.

The performance of these absorbers improves the smaller the length of the incident wave in relation to the dimensions of the irregularities of their surfaces. Therefore, their performance improves with increasing frequency, and it is usually at least good at most conversational frequencies. Because of their high air content, their acoustic impedance Z is very close to that of the air (Z_{air}). Then, most of the energy of the incident wave will tend to penetrate the material, and only a small fraction will be reflected.

The fibrous absorbent materials par excellence are glass wool and rock wool. However, the performance of many materials, everyday objects, and even people in

different conditions has been studied from the point of view of their behavior as acoustic absorbers.

It should be taken into account that for a fibrous absorbent material to work well, its pores must not be clogged. When they are mounted in a polluted atmosphere place, their performance will decline if the pores become saturated with particles. Sometimes to protect them, they are covered with fabric or even with a grid or perforated plate, although strictly some acoustically active surface is lost. They should not be covered with rigid materials that hide them completely, since it is necessary that the porous/fibrous surface be kept available to absorb the sound.

The thickness of an absorbent material is very important for its performance: the greater the thickness, the more the opportunities to lose energy for the incident wave.

If the absorbent material had an infinite thickness, it could be considered a perfect absorber, and all the energy of the incident wave could be absorbed. But the actual thickness is limited, and there is usually a reflecting surface behind the absorber. The sound waves will be reflected in this material, but they will have to cross twice (round trip) the thickness of the acoustic absorbent to return to the emitting room. They suffer a lot of reflections to get through, and they lose energy in each of them, mainly by friction or deformation. These energy losses are those that, in short, “spend” the acoustic energy and reduce the amplitude of the reflected wave that returns to the emitting environment.

In porous or fibrous absorbent materials, it is valid to assume that the sound pressure level decays linearly with the thickness.

An empirical result is that the best performance is given for a material thickness equal to or greater than a quarter of the wavelength ($\lambda/4$), so these materials will be effective for medium to high frequencies. For example, for a frequency of 1.000 Hz, the corresponding wavelength is 34 cm, and then $\lambda/4$ is 8.5 cm, which would be a reasonable thickness of fibrous absorbent material to be placed. Sometimes, when it is desired to extend the operating range, faceted foams or anechoic wedges are placed, which may have surface irregularities of several centimeters in height (15 cm and even more).

To improve performance at low frequencies, an air chamber can be left between the absorbent material and the rigid face to be treated. Although in theory the minimum distance between the absorber and the facing should also be at least $\lambda/4$ of the main frequency to be absorbed, it is empirically recommended that the separation be at least $\lambda/10$.

As the thickness of the air chamber increases, the best performance of the material moves to lower frequencies. The same occurs when a protection is applied over the absorbent material.

The density of the material improves the performance as it increases to an optimal point, but if it continues to increase even more, the material will gain rigidity, and its performance will worsen, as it will start to perform more like a solid than a fibrous material (it will no longer be composed mostly of air). In general, it is assumed that the density of a fibrous sound absorbent material should not exceed 100 kg/m^3 .

There are many ways to mount the absorbent materials on different surfaces (walls, ceilings, floors); they can also be installed as suspended panels. The value of α could vary not only with the frequency of the incident wave but also with the way the material is installed.

Figure 3 shows acoustic absorbers made with waste from the textile industry (weaving). These panels were made with agglomerated wool remnants that were then surface-patterned to improve their absorption and diffusion characteristics. They are low-cost panels developed at the University of the Republic (School of

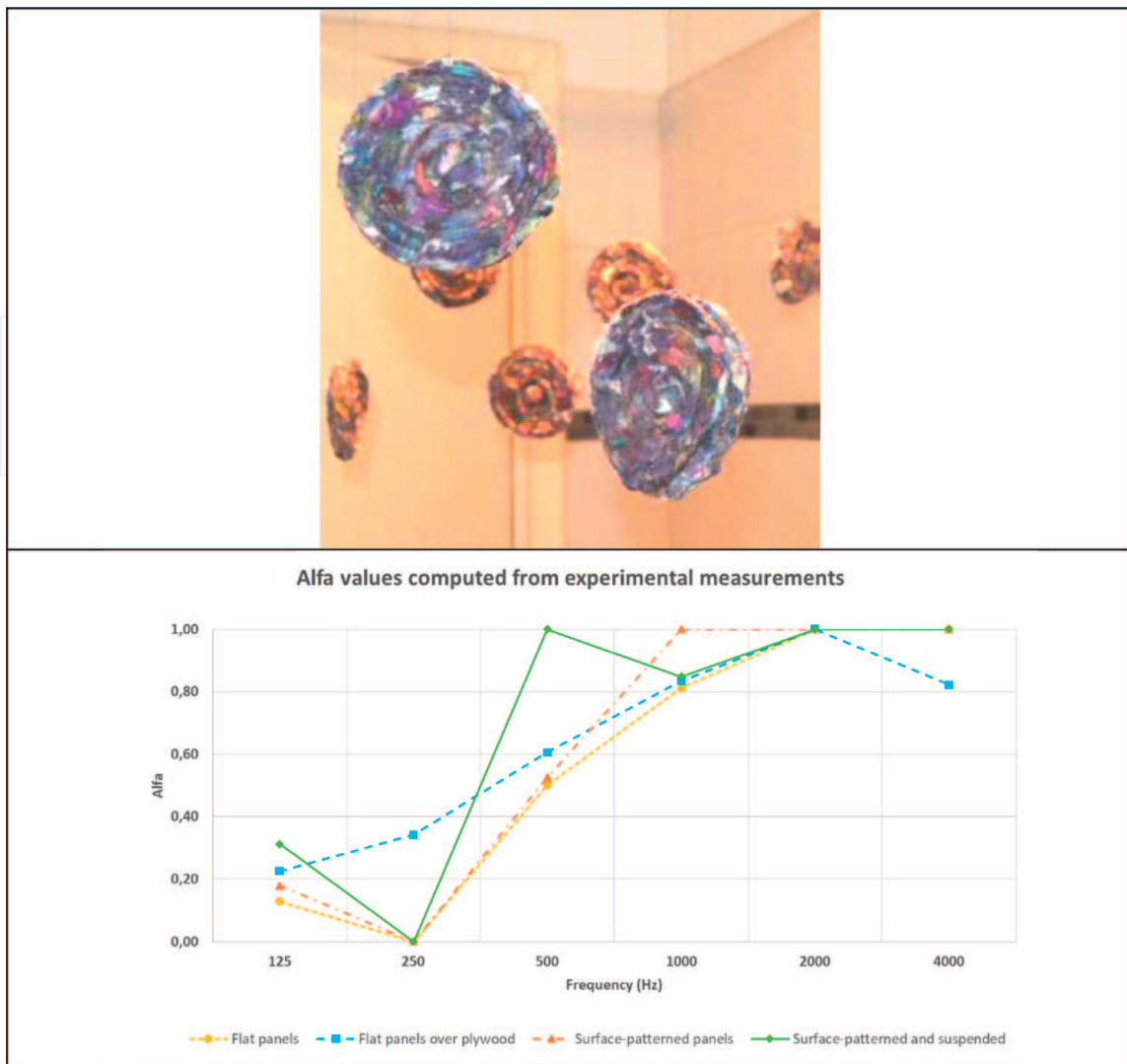

Figure 3. Acoustic absorbers made with weaving wastes. Up: suspended mounting. Down: experimental absorption coefficient for different ways of mounting.

Design and Faculty of Engineering) that demonstrated good acoustic performance and very low manufacturing cost, in addition to allowing the recycling of a very common waste in Uruguay [3].

2.2 Membrane or plate absorbers

A membrane or plate absorber is an air impervious material fixed at its edges at a certain distance from a rigid surface, so as to leave a tight cavity between both (**Figure 4**). When the stiffness of the material is negligible in relation to the tensions that hold it, it is said to be a membrane; when its stiffness must be considered, the material is said to be a plate.

The best performance of the plate is expected to occur at its resonance frequency and can be calculated as

$$f_r = \frac{60}{\sqrt{md}} \quad (5)$$

where m is the surface mass of the plate, in kg/m^2 ; and d is the distance from the panel.

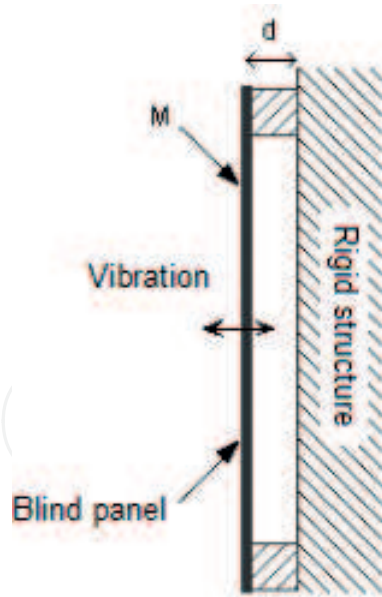

Figure 4.
 Typical acoustic absorber panel.

In any case, the value of α coefficient of these plates is usually not more than 0.50. Since the surface mass of the panels has a practical minimum, these absorbers are useful only at low frequencies. Increasing the mass m of the panel or the distance d lowers the resonance frequency. If the cavity is filled with a soft material, the operating range broadens in terms of frequencies, but in turn it lowers the maximum value of α of the plate.

2.3 Resonator absorbers

The acoustic resonators consist of a cavity that communicates with the outside by a narrower conduit or neck, and of such dimensions they can dissipate energy in a certain frequency, that is, its resonance frequency (**Figure 5**).

The resonance frequency of a Helmholtz-type resonator can be calculated as follows:

$$f_{res} = \frac{c}{2\pi} \cdot \sqrt{\frac{S}{V l_e}} \quad (6)$$

where S being the neck area of the resonator, in m^2 ; V the inside volume of the resonator, in m^3 ; and l is the effective length of the neck of the resonator, in m: $l_e = l_{real} + 1.7 r$; r the radius of the neck, in m.

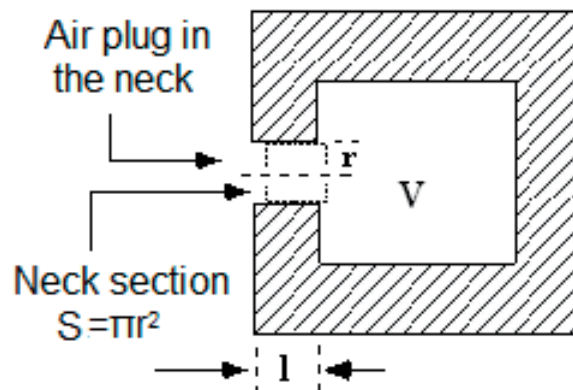

Figure 5.
 Outline of a Helmholtz acoustic resonator (adapted from [1]).

As these devices are very selective, they are generally used only when a reverberation has to be eliminated at a well-defined frequency or, in any case, in a fairly narrow frequency range. If some sound absorbent material is placed inside the cavity and especially close to the neck, the range of frequencies absorbed by the resonator can be expanded somewhat, but the efficiency in the frequency of better performance will decrease.

The construction of Helmholtz resonators is usually done by panels with circular or linear perforations, where the total area of the resonator is the sum of the areas of all the holes.

3. Sound insulation

Airborne sound propagation is usually due to the elastic vibrations of the air due to the sound waves that reach a material surface and excites it. It also occurs, more easily, through evident discontinuities (e.g., openings) or unwanted weak spots (such as cracks, weakly sealed passages for electrical, sanitary or other installations, ventilation ducts, and openings that do not close properly or whose frames are poorly sealed, among other possible imperfections).

3.1 How does sound insulation occur?

The acoustic insulation of a material or a set of them refers to the property to oppose and, consequently, to reduce the flow of acoustic energy that passes through it. A good acoustic insulation reduces the acoustic energy that is received on the other side of it, affecting the amplitude of the wave but not through dissipative phenomena, as the acoustic absorbers do.

The acoustic insulation is based on the modification of the amplitude of a wave when passing from a medium of acoustic impedance Z_1 to another of acoustic impedance Z_2 . The relationship between the acoustic impedances does not only have to do with the modification of the amplitude of the incident wave: it is also related to the fraction of the incident energy that will be reflected or transmitted. Most of the acoustic properties of materials can be studied by the application of new laboratory and numerical methods as ultrasonic characterization [4], inverse characterization with basis on the acoustic impedance measurement [5], or ensemble averaged scattering [6].

The factors of reflection and transmission can be written according to the values of the impedances of the two media involved:

$$F_r = \left(\frac{Z_1 - Z_2}{Z_1 + Z_2} \right)^2, \quad F_t = \frac{4Z_1Z_2}{(Z_1 + Z_2)^2} \quad (7)$$

It can be seen that for similar values of Z_1 and Z_2 , the reflection coefficient F_r tends to zero, and the more different their values are, the value of F_t tends to zero.

Then, the greater the difference between the values of Z_1 and Z_2 , the greater the fraction of the energy of the incident wave that will be reflected, and, consequently, the non-reflected energy, which comprises the energy absorbed and the energy transmitted, will be lower. Implicitly, even if the absorption were not significant, a large difference between the impedances of the two media tends to reduce the amount of acoustic energy transmitted. Taking into account both premises at the same time, when a wave propagates by air and reaches a material

surface, most of the energy will be reflected, and only a small portion will be transmitted to the wall, as its acoustic impedance is undoubtedly much greater than that of air. When passing from the wall again to the air, most of the energy will be again reflected inside the wall, and only a small portion will be transmitted to the air. Then, the transmitted wave will have a smaller amplitude than the wave that would result if the propagation media has not changed (Figure 6).

The transmission coefficient τ of a material is then the relation between the transmitted energy and the incident energy:

$$\tau = \frac{E_t}{E_i} \quad (8)$$

The acoustic reduction index R is defined with basis on τ :

$$R = 10 \log \frac{1}{\tau} \quad (9)$$

3.2 Acoustic performance of a single wall

A single wall in acoustics is formed by only one foil. If it is a macroscopically homogeneous wall, its acoustic insulation will depend on several of its mechanical properties.

Intuitively, a simple and homogeneous wall offers good sound insulation when it is heavy and tight to the passage of air but only weakly rigid. A more rigorous analysis allows recognizing several zones with different behavior, as shown in Figure 7: the design zones are those controlled by mass or by coincidence; the zones controlled by stiffness or resonance refer to a poor and irregular acoustic performance.

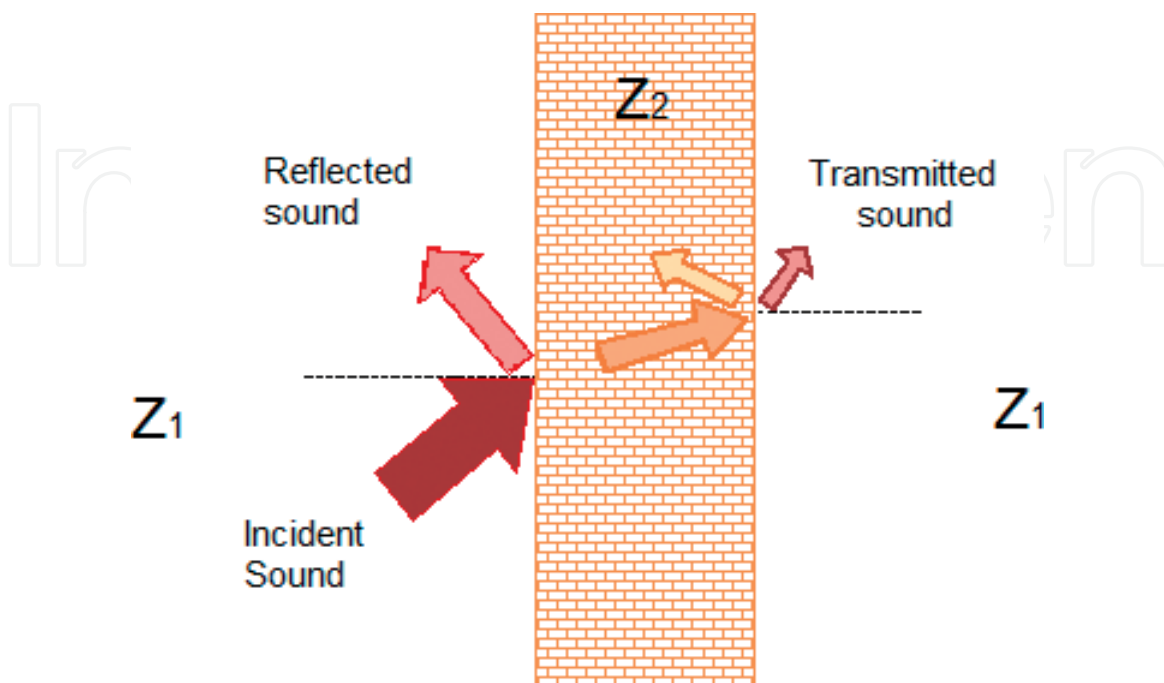

Figure 6.
Destinations of the acoustic energy that reaches a wall.

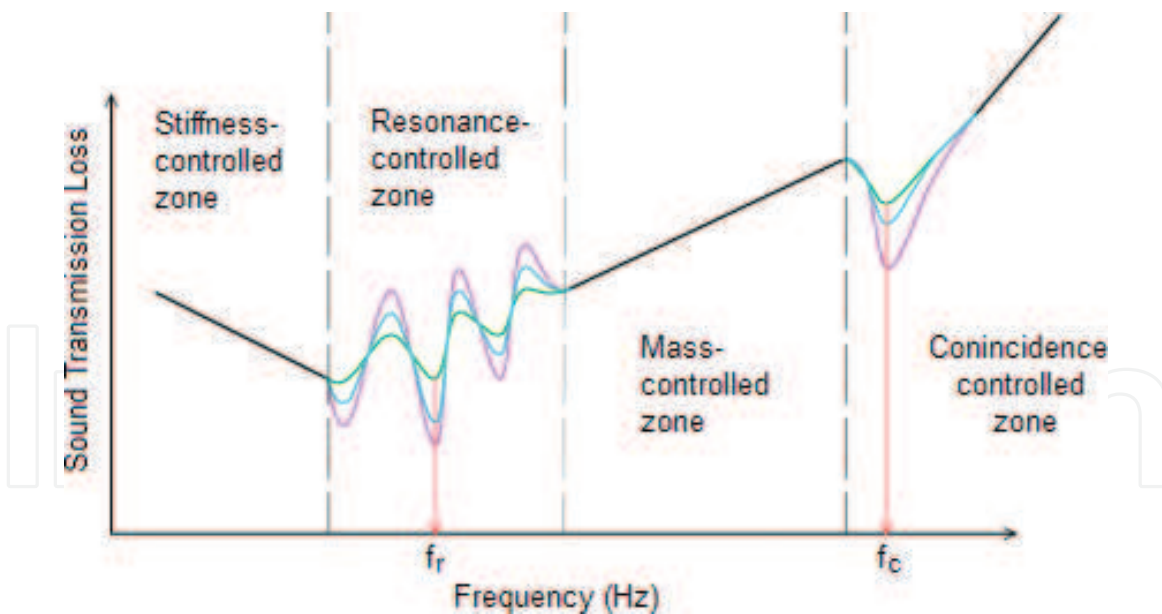

Figure 7. Acoustic performance of a simple homogeneous wall (adapted from [7]).

1. **Stiffness-controlled zone:** it corresponds to the lowest frequencies, below the frequency of resonance f_r . The greater the stiffness k^1 , the poorer the insulation of the wall. The resonance frequency f_{res} can be calculated as:

$$f_{res} = \frac{1}{2\pi} \sqrt{\frac{E e}{m S}} \quad (10)$$

where m is the surface density² of the material, kg/m^2 ; e the thickness of the wall, in m ; S the area of the wall, in m^2 ; and E is the Young modulus of the material, in N/m^2 .

2. **Resonance-controlled zone:** it occurs between f_{res} and $2f_{res}$. In this zone, the behavior is irregular and unpredictable; points of very poor performance are alternated with others that are quite good.
3. **Mass-controlled zone:** it is the preferred zone for acoustic design. It covers from $2f_{res}$ to half of the critical or coincidence frequency f_c . The insulation depends on the surface mass and the frequency of the incident wave. It is usually computed according to the so-called masses law. An improvement of insulation of about 5.4–6 dB is expected each time frequency or mass duplicates. Close to the extremes of this zone, the wall insulation performance is rather poor.

The acoustic insulation performance of a simple homogeneous wall in the mass-controlled zone can be computed by the well-known expression of the masses law [4]:

$$TL = 20 \log m + 20 \log f - 42 \quad (11)$$

where m is the surface mass in kg/m^2 and f is the central frequency of the octave band in Hz .

¹ The stiffness k is the ability of a solid to withstand stresses without acquiring deformations. A wall can be idealized as a thin plate, so its flexural stiffness (i.e., the stress generated by a load perpendicular to it) can be expressed as $k = \frac{E}{1-\nu^2} \times \frac{e^3}{12}$, where ν is Poisson's coefficient of the material.

² The surface density or surface mass of a material is the mass of 1 m^2 of it with its current thickness. Otherwise, m is the product of the volumetric density ρ of the material by its thickness e .

A more conservative expression is proposed by [1] to take into account the irregularities and imperfections of the real materials:

$$TL = 18 \log m + 18 \log f - 45 \quad (12)$$

4. Coincidence-controlled zone: it is the zone over the mass-controlled one. In general, the wall performance is similar to that at the mass-controlled one except when frequency is close to the coincidence or critical frequency f_c . At this frequency, the bending waves that propagate in the material can coincide with the sound waves that propagate by the air, generating high amplitude vibrations in the wall. This phenomenon can occur above the so-called critical frequency f_c , which is the one at which the frequency of the incident waves coincides with that of the longitudinal waves of bending of the wall. The insulation weakens, because the acoustic energy is transmitted through the divider in the form of bending waves, coupled with the acoustic waves in the air. This frequency depends exclusively on the material of the wall and its thickness. The critical frequency is calculated as

$$f_c = \frac{c^2}{\pi} \sqrt{\frac{3m}{Ee^3}} \quad (13)$$

where c is the speed of sound propagation in air, in m/s; e the thickness of the wall, in m; m the surface density, in kg/m²; and E is the Young modulus of the material, in N/m².

From $f_c/2$ onwards, the phenomenon of coincidence can occur. Then, $f_c/2$ is often assumed as the limit of validity of the masses law. For frequencies higher than f_c , the acoustic behavior is governed by the internal damping of the material; the insulation grows again from the value corresponding to f_c . In this area, the law of mass is still used, although it is known that there is a very important drop in a frequency close to the critical frequency.

If the critical frequency is expressed as a function of the resonance frequency, they turn out to be inversely proportional, so when selecting a partition with a low resonance frequency, it also has a high critical frequency:

$$f_c = 0.0877 \frac{c^2}{ef_{res} \sqrt{S}} \quad (14)$$

S is the area of the partition (m²).

The critical frequency is also inversely proportional to the stiffness k of the partition. The greater the stiffness is, the lower its critical frequency (and the higher its resonance frequency):

$$f_c = 0.159c^2 \sqrt{\frac{m}{k(1-v^2)}} \quad (15)$$

Table 1 presents the values of the Young and Poisson modules, the volumetric densities, and the critical frequencies for various materials, for a thickness of 1 cm. To obtain the critical frequency f_c for other thicknesses, dividing the value of the table between the new thicknesses in cm is needed.

3.3 Double walls

If the mass of an insulating element is doubled, the acoustic insulation improvement that can be achieved will be of a theoretical maximum of 6 dB, according to

	Young modulus E , $\text{N/m}^2 \times 10^{10}$	Poisson modulus ν , $\text{N/m}^2 \times 10^{10}$	Density (kg/m^3)	Critical frequency for 1 cm thickness (Hz)
Solid bricks	2.50×10^{10}	–	2000	2700
Reinforced concrete	2.61×10^{10}	–	2600	1900
Steel	1.95×10^{11}	0.31	7800	1300
Aluminum	7.16×10^{10}	0.4	2700	1200
Lead	1.58×10^{10}	0.43	11,300	5500
Asbestos cement	1.50×10^{10}	–	1090	1700
Gypsum	4.69×10^9	–	1150	2700
Plasterboard	–	–	875	4600
Glass	6.76×10^{10}	0.22	2500	1200
<i>Pinus</i> wood	1.40×10^{10}	0.18	700	1700
Agglomerated wood	7×10^9	–	750	2700
Plywood	–	–	600	2100
Cork	5×10^6	0.28	250	18,000
Rubber	7×10^6	0.4	1100	85,000
Extruded polystyrene	–	–	33	10,900

Table 1.
Density and critical frequency of some materials (from different sources).

masses law. But if the mass increase is done by distributing it in two not linked elements separated by an air chamber, the performance of the whole is better than that which results simply from doubling the mass of the original element. This is due to the changes in acoustic impedance to which the sound waves are undergoing when passing through the different elements of the set. The acoustic performance is further improved if the two elements are not exactly the same, and it can be even better if a sound absorbent material is placed into the air chamber.

It is very important to meet a real constructive independence between both foils of the wall, since otherwise the whole will not work as a double wall but simply as a wall whose mass is the sum of the masses of the two elements. Distributing nonhomogeneously the total mass is advantageous, since it allows to achieve that both partitions have different critical and resonance frequencies, avoiding the occurrence of frequencies for which the overall performance would be very poor. If the two wall foils are rigidly joined, the insulation of the whole will decrease. If a reasonable independence is constructively achieved (i.e., they do not vibrate together), the resonance frequency of the overall turns out to be

$$f_r = 60 \sqrt{\frac{1}{d} \left(\frac{1}{m_1} + \frac{1}{m_2} \right)} \quad (16)$$

where m_1 and m_2 are the surface masses of both elements, in kg/m^2 ; and d is the thickness of the air chamber or separation between partitions, in m.

Double walls have a good acoustic performance for the frequencies between their resonance frequency and their critical frequency.

The resonance frequency will be lower the greater the masses of the two foils and/or the greater the distance between them. When the air chamber between the two foils of the double wall is filled with absorbent material, the resonance frequency of the whole decreases (about 85 % of the calculated value). The desirable values for f_{res} are less than 100 Hz and as an optimum condition, less than 60 Hz. Close to the resonance frequency, the insulation is very poor; hence, it should be lower than the most probable minimum incidence frequencies (for human speech they can typically be up to 80 Hz and for music, even lower than 40 Hz). For frequencies below f_{res} , the behavior of the set of the double wall is, at most, that of a simple wall with a surface mass equal to (m_1+m_2) , although its performance could be poorer.

The end of the range in which the double wall has its best performance occurs at its critical frequency f_c , which does not depend on the masses of the partitions but only on the distance d between them:

$$f_c = \frac{c}{2d} \quad (17)$$

Every time d equals a whole number of half wavelengths, the acoustic insulation has an important decay. This occurs at the harmonic frequencies of f_c . For these frequencies, stationary waves of $n.f_c$ frequencies ($n = 1, 2, 3, \dots$) occur in the air chamber, which further weaken the insulation.

Stationary waves are periodic waves where the nodes and crests occupy fixed positions that do not vary in time. Because d is an integer multiple of $\lambda/2$, a node will occur on the second foil of the double wall, and the wave will be reflected with very little energy dissipation, with at least one relative maximum remaining in the air chamber. To attenuate this deleterious effect, absorbent material can be placed on one side of the cavity. This not only improves the insulation of the set by dissipating acoustic energy but also improves its acoustic performance by lowering its resonance frequency.

As practical criteria, if the double partition is composed of two light, flexible sheets of surface masses m_1 and m_2 expressed in kg/m^2 , then the distance d between sheets must comply with

$$d \text{ [m]} \geq \left(\frac{1}{m_1} + \frac{1}{m_2} \right) \quad (18)$$

Also, the air chamber might contain a nonrigid porous absorbent material.

Predicting the acoustic insulation of a double wall is not obvious, because of the different phenomena involved in its performance. Referring to laboratory tests is hardly recommended. **Table 2** shows some results from laboratory tests of double walls.

Sometimes not only double walls are used but also three-foiled walls. The involved acoustic phenomena are so complex that laboratory testing is mandatory to determine their acoustic insulation performance.

3.4 Some causes that weaken the acoustic performance of a wall

Although when the calculations are rightly performed, there are some factors that can make the forecasts much more optimistic than the actual acoustic

Description	m(kg/m ²)	Frequencies (Hz)					
		125	250	500	1000	2000	4000
15 cm brick wall with plaster, plus 25 mm glass wool plus 4 cm air chamber plus 25 mm glass wool plus 7 cm concrete	350	40	54	57	65	70	76
30 cm brick wall plus 50 mm glass wool plus 12 cm air chamber plus 30 cm bricks with plaster	s/d	80	90	98	109	111	111
Two 6 mm plywood panels, each one glued to both faces of wood crossbars of 2.5 cm x 7.5 cm and 41 cm separation	12.2	16	18	26	28	37	33
Two 6 mm plywood panels, each one glued to both faces of wood crossbars of 2.5 cm x 7.5 cm and 41 cm separation plus 10 cm air chamber	14.1	14	20	28	33	40	50
Two 5 mm plywood panels with 1.5 mm lead foil between them	25	26	30	34	38	42	44
7 cm light concrete plus 1.5 cm plaster, 20 mm glass wool, 3 cm air chamber, 5 cm light concrete plus 1.5 cm plaster	450	24	33	41	50	60	65
20 cm concrete plus 25 mm glass wool plus 12 cm air chamber plus 25 mm glass wool plus 15 cm brick wall	650	63	72	74	85	91	93
9 cm concrete plus 2.5 cm air chamber plus 65 mm rigid glass wool panel plus 9 cm concrete plus 16 mm gypsum plate	s/d	49	54	57	56	71	81
9 cm concrete plus 6 cm air chamber plus 65 mm rigid glass wool panel plus 9 cm concrete plus 16 mm gypsum plate	s/d	57	65	76	82	86	83
Two 12 mm gypsum plates with a 7 cm air chamber between them	s/d	13	21	33	43	44	39
One gypsum plate 2 x 12 mm and one 12 mm gypsum plate with 7 cm air chamber between them	s/d	18	25	39	47	49	44
Two 2 x 12 mm gypsum plates with a 7 cm air chamber between them	s/d	23	30	45	49	52	52
Two 12 mm gypsum plates with a 2 cm air chamber and 50 mm glass wool between them	s/d	21	35	48	55	56	43

Table 2. Acoustic insulation of some tested double walls (values from [8–10]).

performance of a wall. Two of the main causes of this are the presence of weak points or cavities and the contributions by nondirect transmission (lateral and/or solid), which are usually not considered in the calculations.

Weaknesses and weak points are usually related to cracks in doors and windows, poor sealed joints, passes for electric and sanitary channeling, construction defects, and interstices. The greater the area of the imperfections, the more they will weaken the acoustic insulation of the wall.

Side or flank transmissions can be as or more important than direct transmission through a wall. They can lead to a significant decrease in the expected insulation. Sound transmission by flanks occurs when the lateral divisors are considerably lighter and/or rigid than the main wall. To solve these issues, the acoustic quality of the laterals needs to be improved to avoiding a poor performance of the solution.

4. Acoustic diffusion

The diffusion of sound is a consequence of the multiple reflections and diffractions that it suffers on irregular surfaces or obstacles to propagation. The diffusers are used to achieve a homogeneous sound field by scattering the reflected acoustic energy in all directions. When a diffuse field is achieved, the acoustic energy is homogeneously and isotropic distributed both in space and in time.

The diffusers allow to correct the early and late reflections and the normal modes of a room.

Unlike the systems of isolation and absorption, in which the most important are the characteristics of the material, the diffusers can be built in any material provided a proper surface design. When a good spatial distribution is achieved, a good temporary dispersion is usually achieved as well.

The design of the surface irregularities can be computed according to different numerical sequences with basis on the main principles of acoustic wave interferences [11].

4.1 Phase diffusers (Schroeder's diffusers)

They are usually built as a sequence of thin linear apertures with different depths. The sound waves penetrate the material, experiment many reflections into the apertures, and emerge from them with a different phase, that is, in a different interference pattern. As a consequence, a good acoustic energy scattering is achieved.

The so-called geometric Schroeder's diffusers or RPG diffusers (reflection phase grating) can be modified in order to be used as acoustic absorbers (Schroeder's absorbers) [12]. Caution is needed to avoid obtaining an undesired behavior (sound absorption instead of sound diffusion).

The most frequent design methods are presented below.

1. MLS diffusers (maximum length sequence)

They are designed using a periodic number sequence that decides the position of the apertures on the surface of the material. If the width of the irregularities is reduced, the design frequency of the diffuser will be higher, while if the depth will be higher, the frequencies to be corrected will be lower. The width of the openings is $\lambda/2$ and the depth is $\lambda/4$. This kind of diffusers has a good performance only for one frequency octave.

2. QRD (quadratic residue diffusers)

The surface pattern of these diffusers can be one or two dimensional. The first ones have linear openings of the same width and different depths. The depths are obtained by a periodic sequence. The two-dimensional QRD have square cavities of different depths.

3. PRD (primitive root diffusers)

They have linear openings of different depths, but they do not suit a periodic pattern because of the number sequence used for the design.

4.2 Crystal-structured diffusers

A crystal structure is an atomic or molecular basic pattern that is identically repeated for many times with the same special distribution and the same

orientation. The attraction forces are maxima and are responsible for maintaining the crystal structure.

A sound crystal is also a repetitive structure that causes a recursive scattering by diffraction one time and another [11]. The repetitive properties are the density and the sound propagation speed of the materials that compose the crystal. To meet the desired effect, the wavelength to be controlled should be similar to the dimension of the materials. Crystal sound diffusers have different applications; for example, they are used for the top part of sound barriers.

5. Conclusions

The main acoustic phenomena involved in enclosed ambiances have been presented: acoustic absorption, insulation, and diffusion. A physical explanation of each one has been done, and the main points for their practical application have been summarized.

For the improvement of the acoustic quality of a room, working on its internal surface materials is needed to control the sound absorption (avoiding excessive reverberation) and sound diffusion (avoiding preferred sound paths that generate an inhomogeneous sound field inside).

For controlling the acoustic energy exchange of a room with its external environment, working on the acoustic properties of the boundary enclosure is needed, to reach a reasonable independence from outside and inside acoustic ambiances.

Acknowledgements

This chapter is strongly based on the on Notebook 6 (ISBN: 978-9974-0-1540-1) [13] from the series Environmental Acoustics (ISBN: 978-9974-0-1533-3) from the same author. The series comprises nine notebooks. It has been funded by the National Directorate for the Environmental from the Ministry of Housing, Land Ordering and Environment from Uruguay and published as e-books by the Faculty of Engineering from Universidad de la República (Uruguay).

Author details

Alice Elizabeth González

Department of Environmental Engineering, Facultad de Ingeniería, IMFIA,
Universidad de la República, Montevideo, Uruguay

*Address all correspondence to: elizabet@fing.edu.uy

IntechOpen

© 2019 The Author(s). Licensee IntechOpen. This chapter is distributed under the terms of the Creative Commons Attribution License (<http://creativecommons.org/licenses/by/3.0>), which permits unrestricted use, distribution, and reproduction in any medium, provided the original work is properly cited. 

References

- [1] Miyara F. Control de Ruido. Own electronic edition; 1999
- [2] Blanco Álvarez F. Notas de Curso: Tema II.4. Propiedades Acústicas. España: Universidad de Oviedo; 90 pp
- [3] Delgado Pérez L. Paneles para absorción acústica con desechos textiles. Diseño Industrial Textil-Moda [Tesis de grado]. Uruguay: Facultad de Arquitectura, Diseño y Urbanismo, Universidad de la República; Agosto 2017
- [4] Roncen R, Fellah ZEA, Simon F, Piot E, Fella M, Ogam E, et al. Bayesian inference for the ultrasonic characterization of rigid porous materials using reflected waves by the first interface. *Journal of the Acoustical Society of America*. 2018;**144**:210. DOI: 10.1121/1.5044423
- [5] Zieliński TG. Normalized inverse characterization of sound absorbing rigid porous media. *Journal of the Acoustical Society of America*. 2015; **137**(6):3232-3243. DOI: 10.1121/1.4919806
- [6] Gower AL, Parnell WJ, Abrahams ID. Multiple waves propagate in random particulate materials. arXiv: 1810.10816v1 [physics.class-ph]; 2018
- [7] Liarte García S. Procedimientos para la verificación in situ del aislamiento acústico según el DB-HR del Código Técnico de la Edificación. España: Proyecto Fin de Carrera en Ingeniería Técnica Industrial, Universidad Politécnica de Cartagena; Setiembre 2013
- [8] Méndez AM, Stornini AJ, Salazar EB, Giuliano HG, Velis AG, Amarilla BC. *Acústica Arquitectónica*. Argentina: Universidad del Museo Social Argentino; 1994. 238 pp
- [9] Flores Pereita P. *Manual de acústica, ruidos y vibraciones*. Barcelona, España: Ediciones GYC; 1990. 412 pp. ISBN 978-84-87579-00-4
- [10] Recuero López M. *Acústica Arquitectónica. Soluciones Prácticas*. Madrid, España: Editorial Paraninfo S.A.; 1999. ISBN 978-84-28319-55-3
- [11] Fuster Fajardo JM. Estudio de las aplicaciones de los difusores de sonido basados en cristales de sonido [Tesis de Master en Ingeniería Acústica]. España: Universidad Politécnica de Valencia, Escuela Politécnica Superior de Gandía; 2013
- [12] Jiménez Arranz G. Estudio y Diseño de Sistemas para el Acondicionamiento Acústico. [Tesis de Master en Ingeniería Acústica de la Edificación y Medio Ambiente]. España: Universidad Politécnica de Madrid; 2013
- [13] González AE. *Acústica Ambiental. Cuaderno 6: Acondicionamiento Acústico*. Montevideo, Uruguay: Universidad de la República, Facultad de Ingeniería, DIA-IMFIA, 2017. ISBN: 978-9974-0-1540-1