

We are IntechOpen, the world's leading publisher of Open Access books Built by scientists, for scientists

5,300

Open access books available

132,000

International authors and editors

160M

Downloads

Our authors are among the

154

Countries delivered to

TOP 1%

most cited scientists

12.2%

Contributors from top 500 universities



WEB OF SCIENCE™

Selection of our books indexed in the Book Citation Index
in Web of Science™ Core Collection (BKCI)

Interested in publishing with us?
Contact book.department@intechopen.com

Numbers displayed above are based on latest data collected.

For more information visit www.intechopen.com



Multifinger Haptic Interfaces for Collaborative Environments

Manuel Ferre, María Oyarzábal, Alexandre Campos and Mary Monroy
*Universidad Politécnica de Madrid
Spain*

1. Introduction

Haptic interfaces provide users with force information while they are interacting with virtual objects, allowing them to perform manipulation tasks and cooperate. Multi-finger haptic interfaces benefit from the use of several fingers, thereby a large number of degrees of freedom are processed, to improve interaction with virtual environments and increase the sense of immersion.

This chapter introduces a new two-finger haptic interface, known as MasterFinger-2. It improves haptic interaction; grasping objects can be easily reproduced by using this device. This interface is based on an open architecture which allows the control of each finger independently via Ethernet. In this sense, it also permits an easy development of cooperative tasks, where users interact directly with their fingers instead of using a tool.

MasterFinger-2 is based on a modular design in which each finger has its own mechanical structure and electronic controller. A finger is inserted into a thimble with 6 degrees of freedom, any position and orientation can be consequently achieved by each finger. Forces are reflected in any direction since there are three actuators per finger.

2. Overview of Haptic Devices

Haptic interfaces are devices which show tactile and force information to a user interacting with a real or virtual object (Tan, 1994). They allow the user to touch the objects and feel their mechanical properties, *e.g.* texture, hardness, shape etc. They can be also used to remotely manipulate objects, *i.e.* teleoperation.

The term “haptic interface” is frequently used to describe two types of interfaces, tactile devices and kinesthetic devices (Sciavicco & Siciliano, 2000), they differ in the kind of information exchanged with the user and the hardware used to build them. Tactile devices provide only tactile information to users, and none regarding kinesthetics. Kinesthetic devices usually provide information of reflected forces, although they can also provide tactile information.

Tactile information comes from the contact between the user finger and the device. Forces are produced by the device and are high enough to resist user’s hand and arm movements. Kinesthetic devices are usually based on electric DC motors or other actuators exerting

forces on users. On the other hand, tactile devices are based on pins, vibratory elements or air injected to stimulate skin.

The contact interface between user and device in kinesthetic devices can adopt multiple configurations. It can be a joystick grasped by two fingers or it can provide more precise information by stimulating several fingers, *e.g.* exoskeletons. Tactile devices apply generally stimuli to the fingertips through matrices of pins, executed by piezoelectric crystals, servomotors, solenoids or pneumatic systems.

2.1. Tactile Devices

Nowadays, there are not many multifinger tactile interfaces available. EXOS Inc. commercializes Touchmaster; it can be used independently or with the Dexterous HandMaster. Xtensory Inc. commercializes the Tactool system. A completely different system is the Displace Temperature Sensing System (DTSS), commercialized by CM Research, which provides temperature information. Next table shows a summary of these interfaces.

Device	Company	Interface	Actuator	Stimuli	Tactile Sensation
CyberTouch (Immersion)	Immersion	5 fingers and the palm (6 vibrotactile stimulators)	Vibrotactile	Vibration 0-125Hz 1.2N peak-to-peak@ 125Hz	Contact with objects
TouchMaster (Exos, 1993)	EXOS	5 fingers and the palm	Magnetic	Vibration (0-200Hz)	Contact with objects
Tactool System	Xtensory	2 fingers	Pins	Impulse (30g) Vibration (20Hz)	Contact with objects
Displaced temperature Sensing System	CM Research	Through a thimble	Thermoelectric heat pump	Temperature change	Heating / Cooling

Table 1. Tactile Devices

2.2 Kinesthetic Interfaces

Compared to tactile devices, kinesthetic interfaces are generally bigger and heavier due to actuators' force requirements. These devices can couple to the hand by means of an exoskeleton, a glove, a thimble, a joystick, etc. In the following table we give a summary of

some kinesthetic interfaces in which we can observe different ways of coupling the interface to the hand or fingers.

Device	Company	Degrees of Freedom	Main Features
PHANTOM (Massie & Salisbury,1994).	Sensable	6	Serial morphology First three DOF active and last three passive
SPIDAR-G (Kim et al., 2000)	Tokyo Institute of Technology	7	Based on thin steel cables that reflect forces to the end effectors. 3 DOF for translation, 3 DOF for rotation and 1 DOF for grasping
SARCOS (Sarcos)	Sarcos	7	Arm kinematics similar to human arm kinematics
VISHARD 10 (Ueberle et al., 2004)	Technical University of Munich	10	Hyperredundant system. Wide workspace
EXOS FORCE ARMMASTER (Exos, 1993)	Exos	5	Five DOF in the upper part of the arm. Two DOF in the lower part of the arm
CYBERGRASP (Immersion)	Immersion	5 DOF for force feedback (1 for each finger)	18 or 22 force sensors. Sensors to measure flexion and abduction
HIRO-II (Kawasaki et al., 2005).	Gifu University, Japan	6 in the arm 15 in the hand	Force and tactile sensation in all fingertips
MAGISTER-P (Sabater et al, 2007)	Miguel Hernández University, Spain	6	Parallel structure

Table 2. Kinesthetic Interfaces

3. MasterFinger Design

MasterFinger is a modular haptic interface where each finger is independently managed. All modules share mechanical structure and controller. Therefore, it is easy to scale the system from one to three fingers, or more. Next section shows the mechanical design of MasterFinger modules and describes the versions for two and three fingers.

3.1 Design of Masterfinger Module

Each finger is considered as an independent module with its own mechanical structure, controller and communications. Mechanical module design is based on a serial-parallel structure (Tsai, 1999) which confers it a wide workspace with a very low inertia.

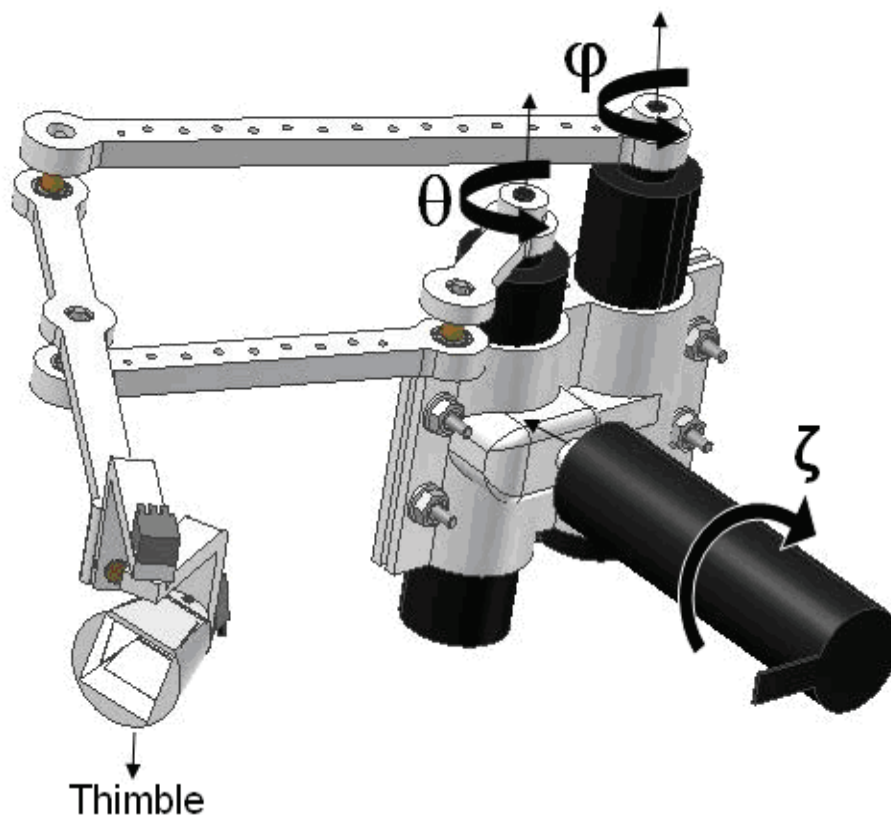

Fig. 1. Design of MasterFinger Modules

This configuration allows a comfortable manipulation since actuator inertia is mainly supported by the base. A module is made up of a six-degree of freedom mechanism and 3 actuators, as shown in Fig. 1. The second and third actuators are linked to a five-bar-structure (Tsai, 1999) providing a wide workspace area. This structure is linked to a thimble by a gimble with three-rotational degrees of freedom. The first degree of freedom allows vertical hand movements – approximately corresponding to the deviation movement ulna-radius in the wrist – while the second and third degrees of freedom are mainly related to finger movements. Figure 2 shows the five-bar-mechanism based on a parallel structure, *i.e.* second and third degrees of freedom.

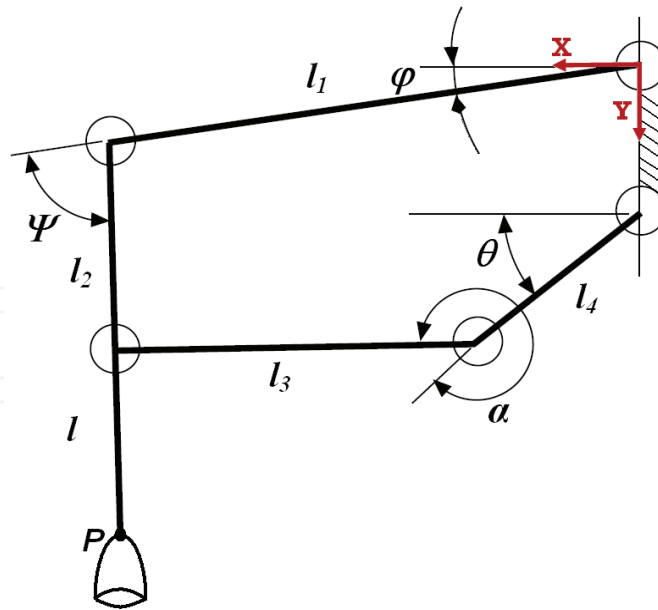

Fig. 2. Schematic view of the two first degrees of freedom.

Equations describing the five-bar-mechanism are the following:

$$x_p = l_1 \cos(\varphi) + l \cos(\varphi + \psi) \quad (1)$$

$$y_p = l_1 \sin(\varphi) + l \sin(\varphi + \psi) \quad (2)$$

φ and θ angles are provided by the encoders, and α and ψ can be calculated as:

$$\psi = \arctan\left(\frac{B}{A}\right) - \arcsin\frac{b}{2l_2\sqrt{b-l_2^2+l_3^2}} \quad (3)$$

where

$$B = -2l_1l_2 + 2l_2l_4 \cos(\varphi - \theta) + 2dl_2 \cos(\varphi) \quad (4)$$

$$A = 2l_2l_4 \sin(\varphi - \theta) + 2dl_2 \sin(\varphi) \quad (5)$$

$$a = l_1^2 + l_2^2 + d^2 - l_3^2 + l_4^2 \quad (6)$$

$$b = a - 2l_1l_4 \cos(\varphi - \theta) - 2dl_1 \cos(\varphi) + 2dl_4 \cos(\theta) \quad (7)$$

and

$$\theta = -\arctan\left(\frac{B}{A}\right) - \arcsin\frac{b}{2l_2\sqrt{b-l_2^2+l_3^2}} \quad (8)$$

therefore,

$$B = 2l_4d - 2l_1l_4 \cos(\varphi) - 2l_2l_4 \cos(\varphi + \psi) \quad (9)$$

$$A = -2l_2l_4 \sin(\varphi + \psi) - 2l_1l_4 \sin(\varphi) \quad (10)$$

$$a = l_1^2 + l_2^2 + d^2 - l_3^2 + l_4^2 \quad (11)$$

$$b = a + 2l_1l_2 \cos(\psi) - 2l_1d \cos(\varphi) - 2l_2d \cos(\varphi + \psi) \quad (12)$$

The Jacobian matrix allows formulating the differential model of joint velocities related to the end effector velocity, in Cartesian coordinates, and joint torques related to forces exerted at the end effector (Mark, 2006). Jacobian matrix is obtained from the following expression:

$$J = J_0 J_d \quad (13)$$

where

$$J_o = \begin{pmatrix} -l_1 \sin(\varphi) - l \sin(\varphi + \psi) & -l \sin(\varphi + \psi) \\ l_1 \cos(\varphi) + l \cos(\varphi + \psi) & l \cos(\varphi + \psi) \end{pmatrix} \quad (14)$$

$$J_d = \begin{pmatrix} 1 & 0 \\ \frac{\partial \psi}{\partial \varphi} & \frac{\partial \psi}{\partial \theta} \end{pmatrix} \quad (15)$$

The thimble orientation is measured by three encoders placed in the corresponding gimble joints. Fig 3 shows further thimble and gimble details. The thimble can be oriented in any direction in order to guarantee free movements of the finger. The three rotational axis of the gimble intersect on the user's finger tip. This geometrical configuration avoids torque reflection, *i.e.* only forces are reflected to the user's finger. The thimble has been developed

to completely enclose the operator finger. The thimble includes four Flexiforce sensors by Tekscan Inc. These sensors are used to estimate normal and tangential forces exerted by the user. Normal forces are obtained from the sensor placed at the thimble bottom in contact with the finger tip. Tangential forces (Burdea 1996) are estimated from three sensors placed on the thimble inferior and lateral faces, respectively. Figure 3 gives two views of the thimble with these sensors.

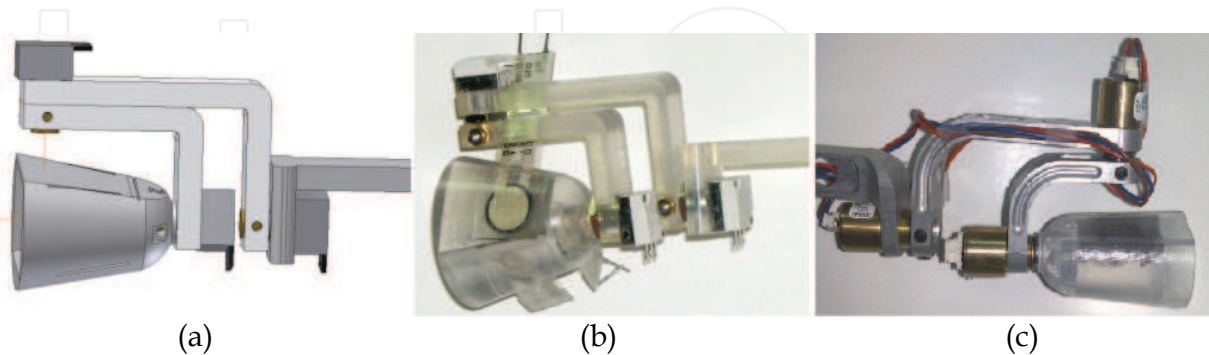

Fig. 3. Lateral and frontal view of thimble and sensors: a). CAD. (b). Resine prototype. (c)Aluminium prototype

All MasterFinger v1.0 components were initially built through a technique of rapid prototyping, stereo-lithography, using epoxy resin. The resin low weight allows an easy manipulation of the entire interface. However, the clearance from the material provokes problems regarding high precision. A second prototype has been built in aluminium aiming to obtain a better precision keeping low weight and inertia effects, which improves the user manoeuvrability. In order to obtain the reflected forces, three DC motors (Maxon RE 25, 10W) with a 225/16 reduction-planetary gear unit GP26 are used. These motors include also a 1000-pulse-per-revolution encoder providing motor orientation.

3.2 MasterFinger Architecture

MasterFinger-2 is made up of two modules, placed in such a way that the index and thumb fingers can handle it. It allows the user to interact with virtual environments in an easy and comfortable way for grasping tasks. Both modules are connected to the interface base with an additional joint to increase the workspace of this haptic interface. The first motor of both modules is on a horizontal plane; therefore, device inertia is significantly reduced. Figure 4 shows a general view of MasterFinger-2.

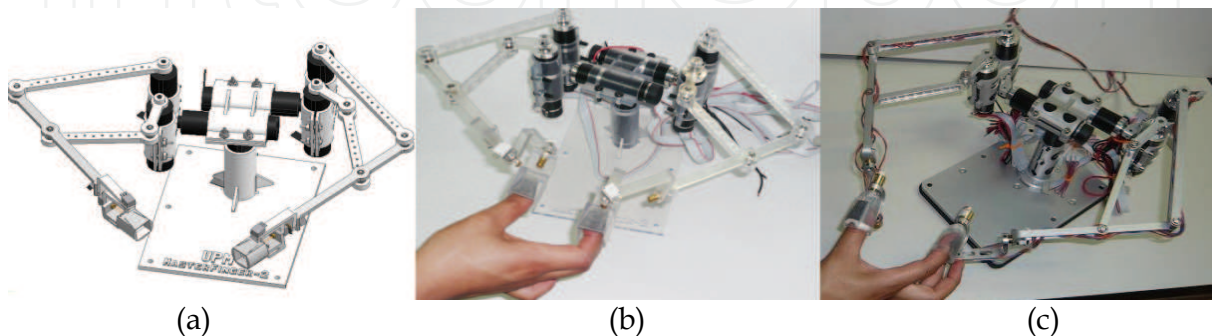

Fig. 4. Masterfinger-2: six degrees of freedom for each finger: (a). CAD model. (b). Resine prototype. (c).Aluminium prototype

It is advisable to notice that the module allows two different configurations, *i.e.* up-elbow and down-elbow, as shown in figure 4 (a). A workspace analysis was made aiming to compare these two options. According to figure 5, the up-elbow configuration has a bigger workspace than the down-elbow configuration. For this reason we block a joint in the five-bar mechanism in order to avoid down-elbow configurations. This workspace represents the volume where finger tips can be located, close to a 300 mm diameter sphere, hand movements correspond therefore to a wider space.

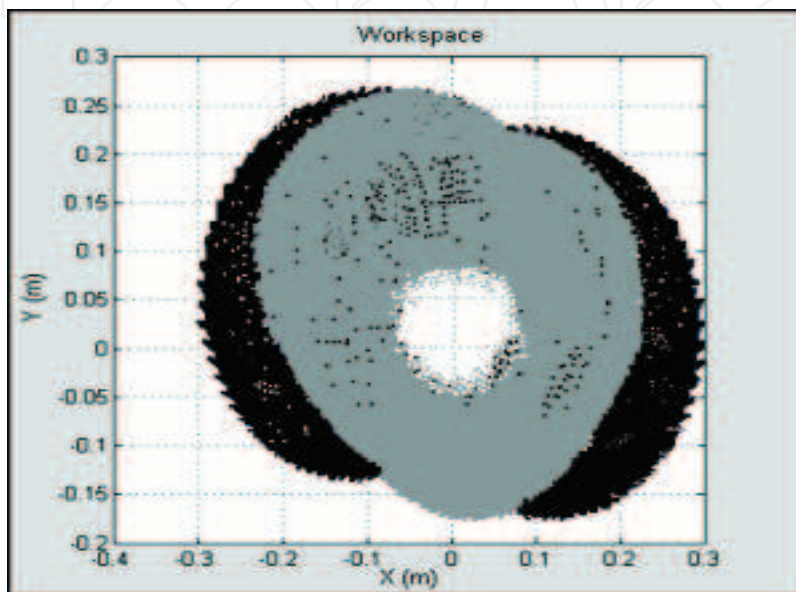

Fig. 5. MasterFinger-2 workspace. The black area represents the workspace covered by the up-elbow configuration and the grey area the one by the down-elbow configuration.

Additionally, technical features of MasterFinger-2 are described as follows. MF-2 weighs approximately 2400 gr, so it can be easily transported to different locations. Each finger controller is provided with Ethernet access and each one uses a switch which works at 100 Mbits per second. UDP acts as the communication protocol; packets are transmitted at 200Hz between MasterFinger-2 and a computer that manages the environment simulation.

3.3 Prototype for a three-finger haptic interface

Some preliminary MasterFinger-3 designs have already been developed. They are currently under evaluation. MasterFinger-3 is a haptic interface for three fingers; thumb, index and either the middle or ring finger. This device will be made up of three modules which will be independently controlled. Figure 6 shows some designs developed so far around the MasterFinger-3 mechanical structure.

The design shown in figure 6a represents a MasterFinger-2 extension where the third module is attached to the common base of the haptic interface. The main advantage of this design is given by its reduced weight. Figure 6b shows the second design. This mechanism has a wide workspace, as its first degree of freedom is provided by a pulley system moving the device base. It also has an additional degree of freedom between the index and middle finger, known as “abduction movement”.

Figure 6c shows the third design with the abduction movement between index and middle fingers too. It has a small wheel in the inferior part of the third module to better support the motor weight.

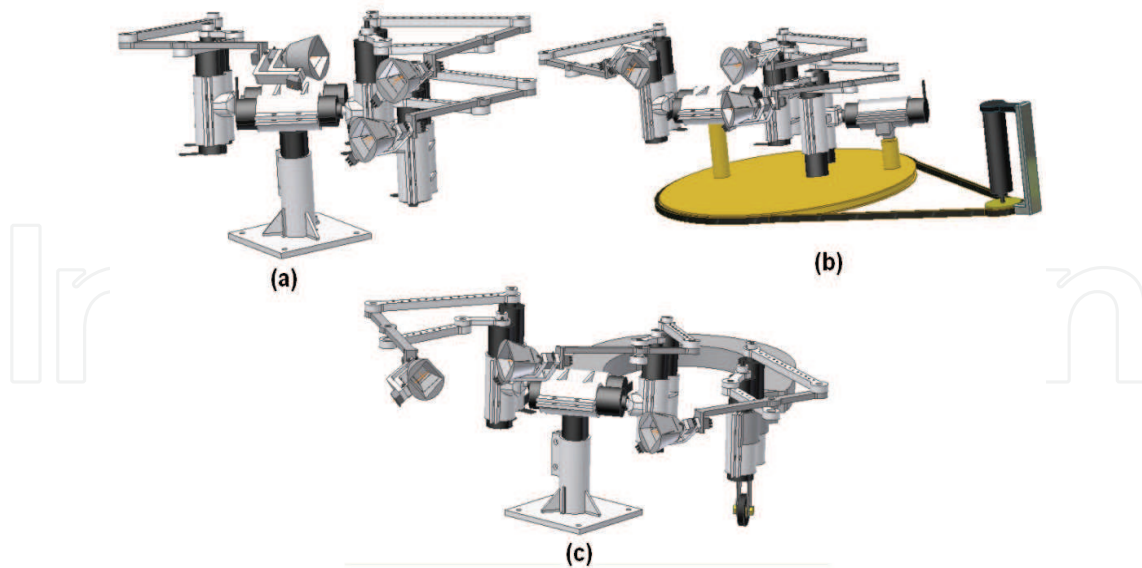

Fig. 6. Three different Masterfinger-3 designs

4. MasterFinger-2 Applications

The Masterfinger-2 has been designed to provide precise grasping using the thumb and index fingers. MasterFinger-2 is very suitable for cooperative tasks where two or more users are manipulating a virtual object. A networked architecture has been developed for this kind of application.

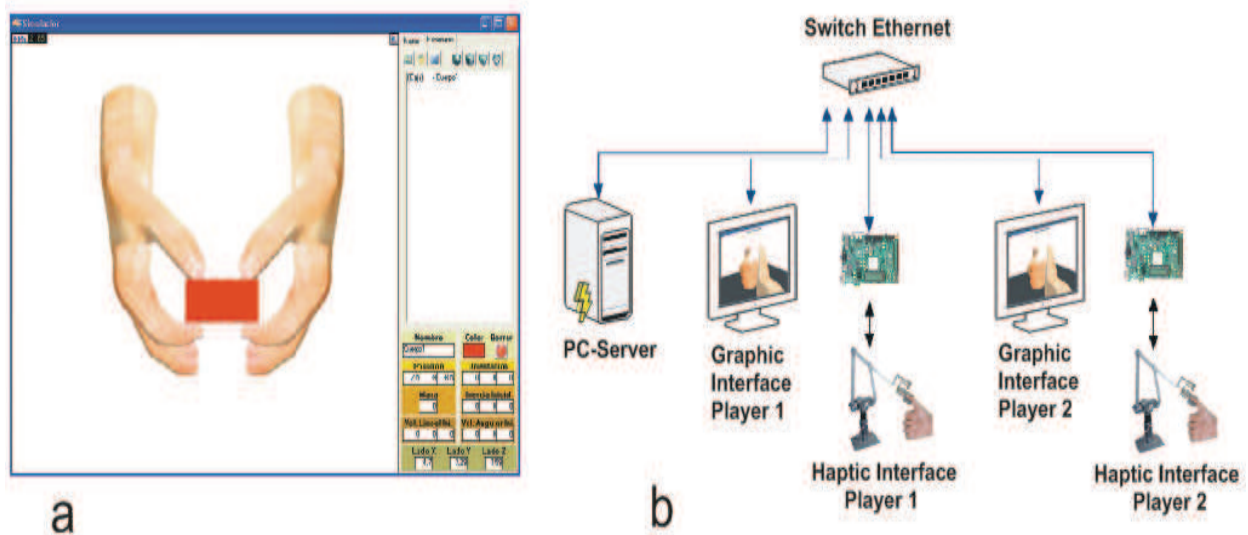

Fig. 7. a) Graphic Interface POP. b) Communication model

A computer is in charge of managing all scenario information. Haptic devices exchange continuously data with their controllers. A graphical display shows the object behaviour into the virtual environment. Figure 7a shows an example of this kind of virtual manipulation. This scenario can be used either by a user who manipulates a virtual object

with both hands, or by two users manipulating the same object. Figure 7b shows the communication scheme. Haptic interfaces are linked to a controller connected to an Ethernet switch. Information is sent to a server that computes kinematics, evaluates an algorithm to detect contacts in the virtual world and controls the entire device. Once the server has all necessary data, it sends the corresponding commands to the haptic interfaces. Graphical information is also updated by the simulations given by the user hand movements.

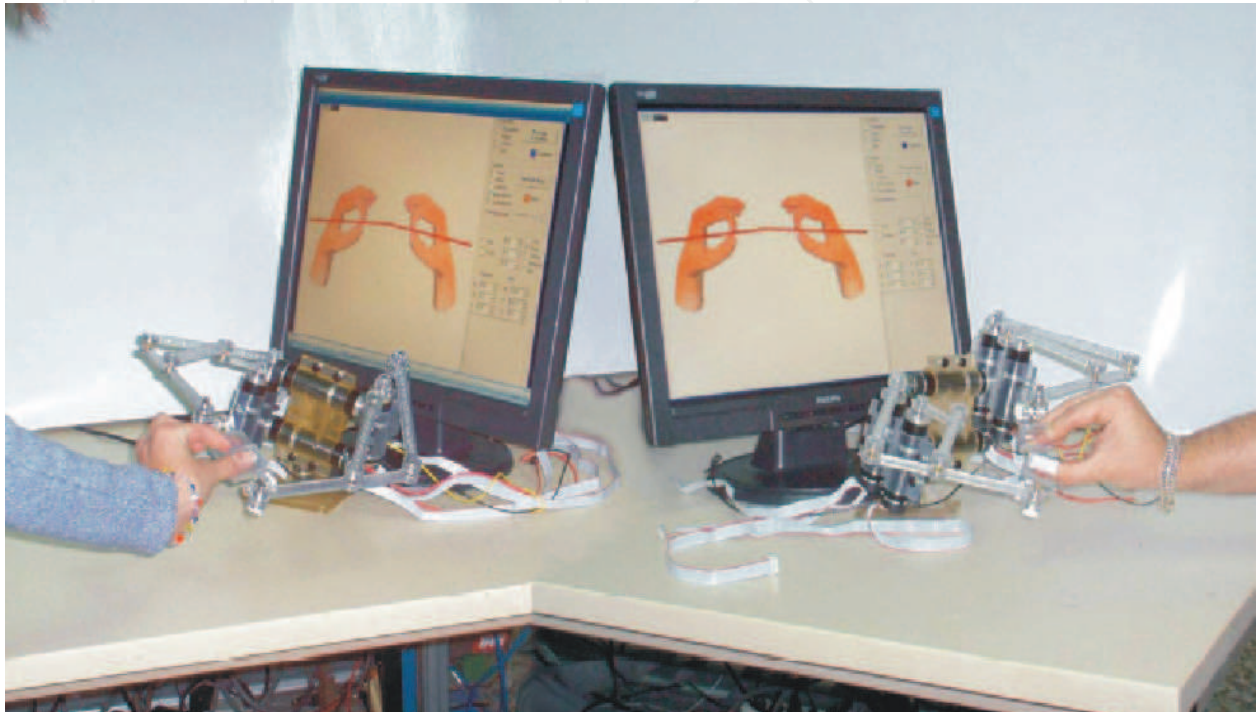

Fig. 8. Interaction between two users in the same physical and virtual environment

Figure 8 shows a further example of cooperative manipulation. In this case, two users are grasping the same virtual object. The objective is to manipulate a thin bar using thumb and index fingers.

5. Conclusions

The development of the MasterFinger haptic interface has demonstrated the multifinger haptic interaction relevance in the manipulation of objects and in the execution of cooperative tasks. The modular design of MasterFinger architecture allows this interface to easily scale up from 1 finger to 3 fingers. The MasterFinger-2 shows a good behaviour as a haptic interface thanks to its low weight and inertia effects upon the user. It allows developing high realistic applications where one or more users are performing cooperative tasks.

Applications have proven the relevance of a multifinger device for properly grasping and manipulating virtual objects. It has required a distributed architecture to properly control the interaction in the virtual environment since many devices and processes, such as graphical displays, haptic devices and environment simulations are running at the same time. It represents a step forward for haptic applications since current environments are based on some devices linked to a stand alone computer. However, advanced developments

for multifinger and multiuser haptic applications require a networked configuration in order to properly distribute processes.

6. References

- Bouzit, M., Burdea, G., Popescu, G., Boian, R. (2002). *The Rutgers Master II - New Design Force-Feedback Glove*. IEEE Transactions on Mechatronics, vol. 7(2), (June 2002).
- G. Burdea. (1996), *Force and Touch Feedback for Virtual Reality*: John Wiley & Sons, 1996, RES (Ch. 6: *Tactile Feedback Interfaces*).
CyberGlove and Cybergrasp User's Guide, IMMERSION Corp.
<http://www.immersion.com/3d/docs/CGIIManual.pdf>
- Exos Co., (1993). TouchMaster and Force ArmMaster Specifications, Company Brochure, Woburn, MA.
- H. Choset, K.M. Lynch, S. Hutchinson, G. Kantor, W. Burgard, L.E. Kavraki, and S. Thrun, *Principles of Robot Motion: Theory, Algorithms, and Implementation*. Cambridge, MA: MIT Press, 2005.
- H. Kawasaki, T. Mouri, M. Osama, Y. Sugihashi, Y. Ohtuka, S. Ikenohata, K. Kigaku, V. Daniulaitis, K. Hamada and T. Suzuki. (2005) *Development of Five-Fingered Haptic Interface: HIRO II*, Proc. of ICAT 2005, Christchurch, New Zealand, pp. 209-214, 2005 Immersion Corp., CyberTouch, CyberGlove and Cybergrasp User's Guides
<http://www.immersion.com/3d>
- J.M Sabater, R. Aracil and L. Payá . (2007) *A Novel Parallel Haptic Interface for Telerobotic System*, in Advances in Telerobotics, M. Ferre et al. Springer STAR series, pp. 45-60 2007
- J.J. Craig (2005), *Introduction to Robotics: Mechanics and Control*, 3rd ed. Upper Saddle River, NJ: Pearson/Prentice-Hall, 2005.
- L. Sciavicco and B. Siciliano. (2000), *Modelling and Control of Robot Manipulators*. New York: Springer, 2000.
- Mark W. Spong, Seth Hutchinson, and M. Vidyasagar. (2006). *Robot Modeling and Control*, Wiley, 2006.
- M. Ueberle, N. Mock, A. Peer, C. Michas, and M. Buss. (2004). "Design and Control Concepts of a Hyper Redundant Haptic Interface for Interaction with Virtual Environments", Proceedings of the IEEE/RSJ International Conference on Intelligent Robots and Systems IROS, Workshop on Touch and Haptics, Sendai, Japan, 2004.
- R. Murray, Z. Li, and S. Sastry. (1994), *A Mathematical Introduction to Robotic Manipulation*. Boca Raton, FL: CRC Press, 1994. Sarcos Research Corporation. Sarcos Dextrous Arm. http://www.sarcos.com/interspec_dexmaster.html
- S. Kim, M. Ishii, Y. Koike, and M. Sato. (2000). *Design of a Tension Based Haptic Interface: SPIDAR-G* Proceedings of World Multiconference on Systemics, Cybernetics, and Informatics: SCI 2000. pp 422-427, July 2000
- Tan, H. Z., Srinivasan, M. A., Eberman, B., & Cheng, B. (1994). *Human factors for the design of force-reflecting haptic interfaces*, *Dynamic Systems and Control (ASME)*, 55(1).
- T. H. Massie and J. K. Salisbury. (1994). *The PHANTOM Haptic Interface: A Device for Probing Virtual Objects*. In: *Proceedings of the ASME Winter Annual Meeting, Symposium on Haptic Interfaces for Virtual Environment and Teleoperator Systems*. Chicago (USA).

Tsai L-W.: Robot Analysis. (1999). *The Mechanics of Serial and Parallel Manipulators*. John Wiley & Sons, INCI, 1999.

IntechOpen

IntechOpen



Human Computer Interaction

Edited by Ioannis Pavlidis

ISBN 978-953-7619-19-0

Hard cover, 522 pages

Publisher InTech

Published online 01, October, 2008

Published in print edition October, 2008

This book includes 23 chapters introducing basic research, advanced developments and applications. The book covers topics such as modeling and practical realization of robotic control for different applications, researching of the problems of stability and robustness, automation in algorithm and program developments with application in speech signal processing and linguistic research, system's applied control, computations, and control theory application in mechanics and electronics.

How to reference

In order to correctly reference this scholarly work, feel free to copy and paste the following:

Manuel Ferre, María Oyarzabal, Alexandre Campos and Mary Monroy (2008). Multifinger Haptic Interfaces for Collaborative Environments, Human Computer Interaction, Ioannis Pavlidis (Ed.), ISBN: 978-953-7619-19-0, InTech, Available from:

http://www.intechopen.com/books/human_computer_interaction/multifinger_haptic_interfaces_for_collaborative_environments

INTECH
open science | open minds

InTech Europe

University Campus STeP Ri
Slavka Krautzeka 83/A
51000 Rijeka, Croatia
Phone: +385 (51) 770 447
Fax: +385 (51) 686 166
www.intechopen.com

InTech China

Unit 405, Office Block, Hotel Equatorial Shanghai
No.65, Yan An Road (West), Shanghai, 200040, China
中国上海市延安西路65号上海国际贵都大饭店办公楼405单元
Phone: +86-21-62489820
Fax: +86-21-62489821

© 2008 The Author(s). Licensee IntechOpen. This chapter is distributed under the terms of the [Creative Commons Attribution-NonCommercial-ShareAlike-3.0 License](#), which permits use, distribution and reproduction for non-commercial purposes, provided the original is properly cited and derivative works building on this content are distributed under the same license.

IntechOpen

IntechOpen