

We are IntechOpen, the world's leading publisher of Open Access books Built by scientists, for scientists

5,500

Open access books available

135,000

International authors and editors

165M

Downloads

Our authors are among the

154

Countries delivered to

TOP 1%

most cited scientists

12.2%

Contributors from top 500 universities



WEB OF SCIENCE™

Selection of our books indexed in the Book Citation Index
in Web of Science™ Core Collection (BKCI)

Interested in publishing with us?
Contact book.department@intechopen.com

Numbers displayed above are based on latest data collected.
For more information visit www.intechopen.com



Principles and Application of RF System for Hyperthermia Therapy

Timothy A. Okhai and Cedric J. Smith

Additional information is available at the end of the chapter

<http://dx.doi.org/10.5772/55108>

1. Introduction

In recent times, different strategies for thermal ablation therapy have been in use. They include radiofrequency ablation, cryoablation therapy, laser ablation therapy, microwave ablation and high intensity focused ultrasound ablation, among others. *Radiofrequency ablation (RFA)* is used to destroy pathological tissue by inducing tissue necrosis through the heating of targeted tissue [1]. While ablation is currently used in the treatment of different diseases, tumour ablation is considered here, i.e. the treatment of cancerous tumours. Apart from RFA, thermal ablation therapy involves other strategies employed in the destruction of cancerous tumours. *Cryoablation therapy (or cryotherapy)* uses liquid nitrogen (or the expansion of argon gas) to freeze and kill abnormal tissue. After numbing the tissue around the mass, a cryoprobe, which is shaped like a large needle, is inserted into the middle of the lesion. An ice ball forms at the tip of the probe and continues to grow until the images confirm that the entire tumour has been engulfed, killing the tissue [2], [3]. The whole process involved in cryotherapy takes about 10 – 20 minutes to complete. The temperature and duration of freezing necessary to induce complete killing and necrosis are based on numerous in vivo and in vitro animal studies, some of which have been reviewed by Gage & Baust [4]. Generally, it has been accepted that a minimum freezing temperature of -40°C must be reached for at least 3 minutes for complete eradication of the tumour [5]. A rapid freeze followed by a slow thaw is the most damaging to cells, and a minimum of two freeze-thaw cycles (freeze-thaw-freeze-thaw) was necessary for effective cryonecrosis to take place than a single cycle [6]. The cost of a cryoablation unit ranges upwards from \$190,000, and each multi-use cryoprobe costs approximately \$3,750 [7]. *Laser Ablation (or interstitial laser photocoagulation)* uses a highly concentrated beam of light to penetrate the cancerous tissue. The laser energy is emitted from an optical fibre placed within a needle positioned at the centre of the tumour using either stereotactic guidance or Magnetic Resonance Imaging (MRI) [8], [9]. Two methods for delivery of light have been described to produce larger

volumes of necrosis: multiple bare fibres in an array and cooled-tip diffuser fibres. The major drawback to this technique is its cost, requiring \$30,000 to \$75,000 for a portable, solid-state laser and \$3,000 per set of multiple (50) user fibres [10]. *Microwave ablation (MWA) or microwave coagulation* uses microwave tissue coagulator for irradiation. Ultra-high frequency (2450 MHz) microwaves are emitted from a percutaneously placed microwave electrode inserted into the target tissue under ultrasonographic guidance. Microwave irradiation is carried out for about 60 seconds at a power setting of 60W per pulse. During irradiation, the ultrasonographic probe is placed adjacent to the microwave electrode to monitor the effectiveness of the tumour coagulation [11], [12]. A typical microwave generator costs approximately \$65,000 [13]. *High Intensity Focused Ultrasound (HIFU) ablation* is a non-invasive treatment modality that induces complete coagulative necrosis of a deep tumour through the intact skin. HIFU uses sound energy to produce heat [14]-[16]. HIFU treatments are usually carried out in a single session, often as a day case procedure in the doctor's office, with the patient either fully conscious, lightly sedated or under light general anaesthesia. One major advantage of HIFU over other thermal ablation techniques is that the transcutaneous insertion of probes into the target tissue is not necessary. The high powered focused beams employed in the procedure are generated from sources placed either outside the body (for treatment of tumours of the liver, kidney, breast, uterus, pancreas and bone) or in the rectum (for treatment of the prostate), and are designed to enable rapid heating of a target tissue volume, while leaving tissue in the ultrasound propagation path relatively unaffected [17]. Numerous extra-corporeal, transrectal and interstitial devices have been designed to optimise application-specific treatment delivery for HIFU procedures.

This chapter focuses on the discussion of principles and application of the radiofrequency ablation therapy system as a minimally invasive treatment modality for hyperthermia therapy. Detailed work completed in the use of radiofrequency (RF) energy in cancer management by developing and testing an economical and effective thermal probe that will effectively destroy volumes of pathological tumours by means of hyperthermia is presented.

2. Radiofrequency energy and the RF ablation system

Basically, the term *radio-frequency* refers not to the emitted waves, but rather to the alternating electric current that oscillates in the high frequency range. Radiofrequency is a form of electromagnetic energy. This energy is formed from waves of electromagnetic energy moving together (or radiating) through space at the speed of light. Unlike ionizing radiation (e.g. gamma rays and x-rays), which affects the chemical makeup of cells and alters their genetic code, electromagnetic energy is non-ionizing. This means that it is not strong enough to ionize atoms and molecules in cells or alter their genetic makeup. Radiofrequency energy is safer than many cancer therapies because it is absorbed by living tissue as simple heat. Regardless of the heat source, cells die when they reach a certain temperature. The main tumoricidal effect of RF ablation occurs because the absorption of electromagnetic energy induces thermal injury to the tissue. But RF energy and the heat it generates does not alter the basic chemical structure of cells. A very important part of the RF

ablation system is the RF signal generator. This is where the energy deposited by the needle-like active electrode is generated. The system comprises of a closed circuit consisting of a radiofrequency generator circuit, a power amplifier circuit, and the control circuit. A power supply circuit is also included to meet the power supply requirements of the system. The energy generated by the system is delivered to the tissue by the active electrode, whereas a dispersive electrode that acts as a patient plate provides a return part to complete the circuit. A simplified block diagram of the whole system is shown in figure 1 below.

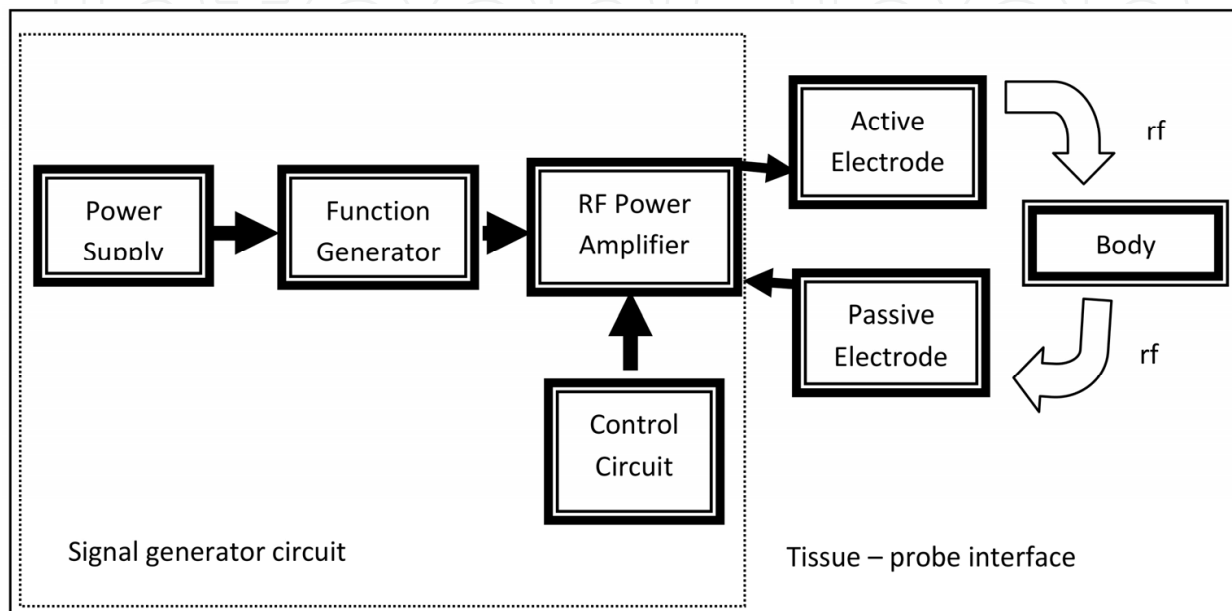

Figure 1. Block diagram of the RF ablation circuits

2.1. Hyperthermic (thermal) coagulation necrosis

Coagulation necrosis denotes “irreversible thermal damage to cells even if the ultimate manifestations of cell death do not fulfill the strict histological criteria of coagulative necrosis” [18]. The nature of the thermal damage caused by radiofrequency heating is dependent on both the tissue temperature achieved and the duration of heating. Here is what happens at various temperatures:

- At 42°C, cells die but it may take a significant amount of time (approximately 60 min).
- Between 42°C and 45°C, cells are more susceptible to damage by other agents like chemotherapy and radiation.
- Over 46°C irreversible damage occurs depending on the duration of heating.
- Between 50°C and 55°C, the duration necessary to shorten irreversible damage to cells is shortened to 4 – 6 minutes.
- Between 50°C and 100°C there is near immediate coagulation of tissue, almost instantaneous protein denaturation, melting of lipid bilayers, irreversible damage to mitochondrial and cytosolic (key cellular) enzymes of the cells, DNA and RNA.
- From 100°C to 110°C, tissue vaporizes and carbonizes, all of which decrease energy transmission and impede ablation.

Figure 2 shows tissue reaction to thermal injury at different temperatures [19]. For successful ablation, the tissue temperature should be maintained in the ideal range (50 – 100°C) to ablate tumour adequately and avoid carbonization around the tip of the electrode due to excessive heating. For adequate destruction of tumour tissue, the entire volume of a lesion must be subjected to cytotoxic temperatures. Hence effective heating throughout the target volume (i.e. the tumour and about 5mm thickness around normal tissue) is required as shown in figure 3. Thus, the main objective of radiofrequency ablation therapy is to reach and maintain a temperature range of 50° – 100°C throughout the entire target volume for at least 4 – 6 minutes. However, the relatively slow thermal conduction from the electrode surface through the tissues increases the duration of application to 10 – 30 minutes.

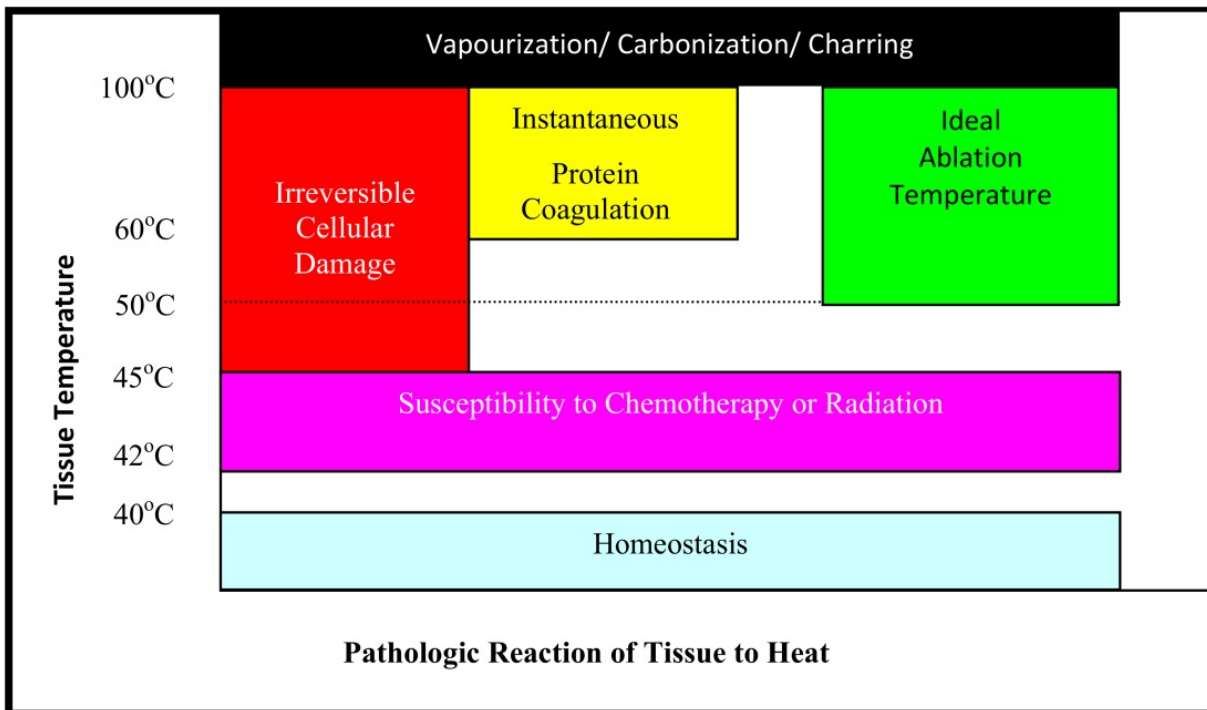

Figure 2. Tissue reaction to thermal injury at different temperatures

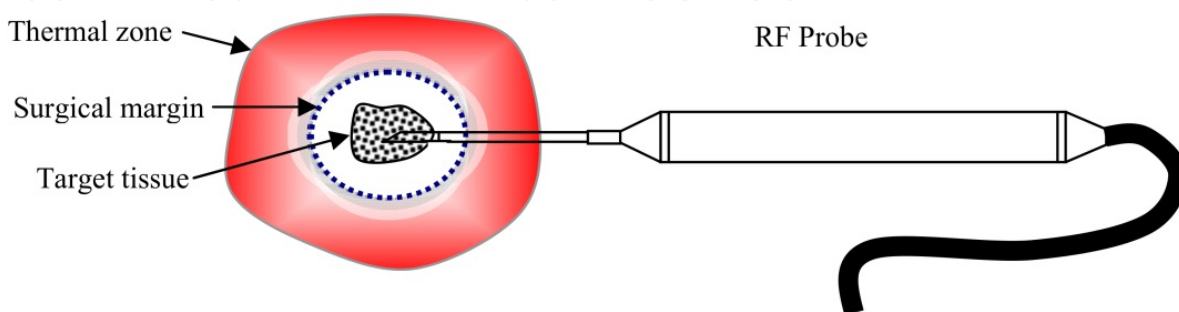

Figure 3. Schematic diagram illustrating RF ablation

Recommendations of heating for these extended durations are based on experimental and clinical data suggesting that thermal equilibrium and, hence, complete induction of coagulation are not achieved for a given radiofrequency application until these thresholds

are achieved. The development of a radiofrequency ablation system in this study is aimed at producing a device that is able to satisfy the minimum requirement for effective tumour ablation at the ideal (cytotoxic) ablation temperature.

2.2. Principles of radiofrequency ablation

Radiofrequency ablation is physically based on radiofrequency current (about 460 kHz) that passes through the target tissue from the tip of an active electrode (RF thermal probe) towards a dispersive electrode which serves as the grounding pad. These two electrodes are connected to a radiofrequency generator. The active electrode has a very small cross-sectional area (a few square millimetres) with respect to the passive electrode. The active electrode is usually fashioned into the form of a needle-like probe that is inserted into the tumour. The dispersive electrode has a much larger area than the active electrode, on the order of 100cm² or larger, and is usually placed firmly behind the right shoulder or the thigh of the subject, depending on the location of the tumour in the body. Current flowing into the dispersive electrode is the same as the current flowing into the active electrode. But since the active electrode has a far smaller cross-sectional area than the dispersive electrode, the current density in amperes per square meter (A/m²) is far greater. As a result of the difference in current density between the two electrodes, the energy at the tip of the probe leads to ionic agitation with subsequent conversion of friction into heat. The tissue ions are agitated as they attempt to follow the changes in direction of alternating electric current as shown in figure 4 below.

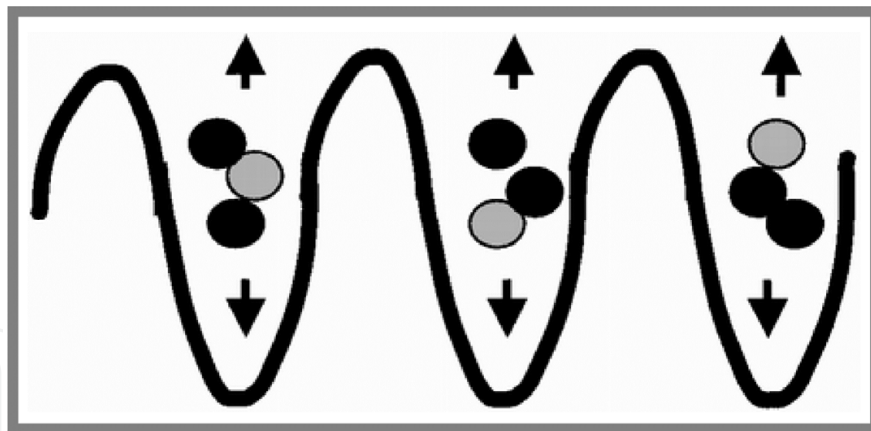

Figure 4. Ionic agitation by alternating electric current

The agitation results in frictional heat around the electrode. The marked discrepancy between the surface area of the needle electrode and the dispersive electrode causes the generated heat to be tightly focused and concentrated around the needle electrode. The use of a large grounding pad ensures maximum surface area for dispersion of current from the needle electrode. The grounding pad also maximizes dispersion of equal amounts of energy and heat at the grounding pad sites, thereby minimizing the risk of burns. The tissue underneath the passive electrode heats up only slightly, while the tissue in contact with the active electrode is resistively heated to elevated temperatures sufficient for tumour ablation

(coagulative necrosis). The strategy of RF ablation is to create a closed-loop circuit including the RF generator, the needle electrode, the patient (tissue) and the passive electrode (grounding pad) in series. The heating of tissue is due to the power dissipated in the tissue, which is found from the expression

$$P = \rho V I_d^2 \quad (1)$$

where P is the power in watts (W), ρ is the resistivity of the tissue in Ohm-metres ($\Omega\text{-m}$), V is the tissue volume in cubic metres (m^3), and I_d is the current density in amperes per square metre (A/m^2).

Appreciable advances have been made over the past decade to produce application devices for RFA. The *Radionics probe* is an internally cooled device that also uses pulsing sequences to improve heating. It is available in one size (17Ga) and 10, 15, and 25cm lengths. It comes with a single electrode with a tip exposure of 2-4cm, or cluster electrode [20]. The *RITA probe* is a 15Ga device that comes with various arrays. It has a thermocouple at the tip of the probe that registers the tissue temperature, and that is used to monitor its effect. The *LeVeen probe* has multiple (36, 37) tines. There are 2.0, 3.0, 3.5 and 4.0cm diameter needles from which the tines are deployed. The LeVeen needle electrode is designed to deliver a consistent pattern of heat throughout the lesion [21]. These and other application devices for RFA are available for use in the USA and some parts of Europe. In spite of technical progress in the development of various application devices for radiofrequency ablation therapy, most patients with malignant tumours, especially in Sub-Saharan Africa, have not yet benefitted from this technology due to their limited availability and exorbitant cost. A typical RF generator costs \$25,000 and each single use probe costs approximately \$800 to \$1200 [22]. This paper presents the structure and experimental results of a low cost minimally invasive radiofrequency thermal probe developed for hyperthermia therapy. The probe developed is effective and economical, and represents more than 70% in cost reduction compared to commercially available reusable RF thermal probes reviewed.

3. Materials and methods

The RF thermal probe developed was designed on a SolidWorks platform and manufactured according to design specifications. The device consists of an RF shielded insulated handle with a needle probe. The shaft of the needle is also insulated except for the tip which makes physical contact with the tumour or volume to be treated. A coaxial cable connects the device to the RF power unit. The RF thermal probe uses a stainless steel needle (size 14G \times 3-1/4) with a diameter and length of 2.1 \times 80 mm, connected to the conducting coaxial cable in one end, and housed in an epoxy resin holder (probe handle) that is 120 mm long and 15 mm in diameter. The stainless steel needle is insulated, except for the exposed 20 mm tip that makes direct contact with tissue. The insulation prevents normal tissue from being destroyed along with cancerous tissue during thermal ablation treatment. The probe (as shown in figure 5) is reusable and is made of epoxy-resin material that can be easily steam-cleaned.

An essential objective of radiofrequency ablation therapy is to achieve and maintain a temperature range of 50 – 100°C throughout the entire target volume for at least 4 – 6 minutes [23-25]. From equation (1), power dissipated (P) is directly proportional to volume (V). Tumour is usually treated as a sphere, and volume of a sphere is given by,

$$V = (4/3)\pi r^3 \quad (2)$$

where r is the radius of the sphere. It follows that, power dissipated is directly proportional to the cube of the radius. The temperature rise follows the accepted cube root heating function. This means that the outer limit of critical cell temperature where cell necrosis takes place is reasonably well-defined by the applied power and will be spherical around a point source if the impedance remains constant. In practice, we have a short cylindrical contact volume in the tumour with non linear impedances. This results in an egg shaped volume being treated.

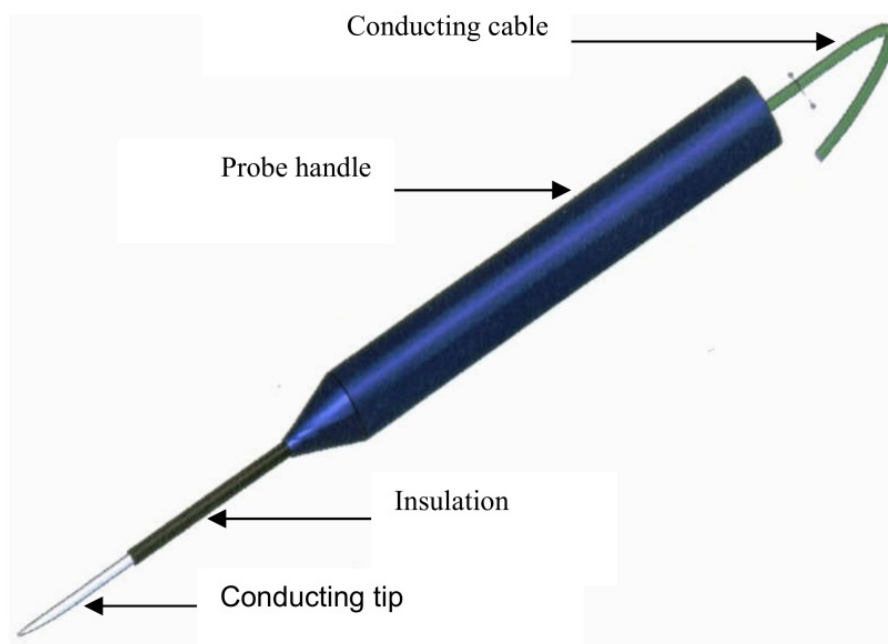

Figure 5. RF thermal probe

To verify that the radiofrequency thermal probe developed is a device that is able to satisfy this minimum requirement for effective tumour ablation at the ideal cytotoxic temperature, experimental tests were done with different tissues types to determine how each tissue type responds to RF energy by observing and recording the temperature change at the probe tip. Liver, lung, brain, kidney and soft tissue were tested at different power settings to determine which power setting gives the best results with each tissue type in terms of the minimum time to reach the ideal temperature range, and the maximum time to remain within this range without charring or vapourizing. An RF generator (460 KHz) was connected in a closed circuit with the RF thermal probe, tissue sample, and dispersive electrode in series. Each tissue type was tested with different power settings, and each test was done for about 15 minutes.

4. Results and discussion

The extent of coagulation necrosis is dependent on the energy deposited, local tissue interaction minus the heat lost.

$$\text{Coagulation necrosis} = \text{energy deposited} \times \text{local tissue interactions} - \text{heat loss}$$

Heat efficacy is defined as the difference between the amount of heat produced and the amount of heat lost. Therefore, effective ablation can be achieved by optimizing heat production and minimizing heat loss within the area to be ablated. The relationship between these factors has been well characterized as the "bio-heat equation." Heat production is correlated with the intensity and duration of the radio-frequency energy deposited. Heat conduction or diffusion is usually explained as a factor of heat loss in regard to the electrode tip. Heat is lost mainly through convection by means of blood circulation. Therefore, the cooling tissue by perfusion can limit the reproducible size of the ablation lesion in vivo.

Macroscopic and microscopic examination of tissue samples tested show clear evidence of coagulation necrosis. A tissue volume of up to 20 mm diameter was necrosed with the single-tine probe developed. The plots of temperature versus time for different tissue types tested using different power settings are presented in the following figures:

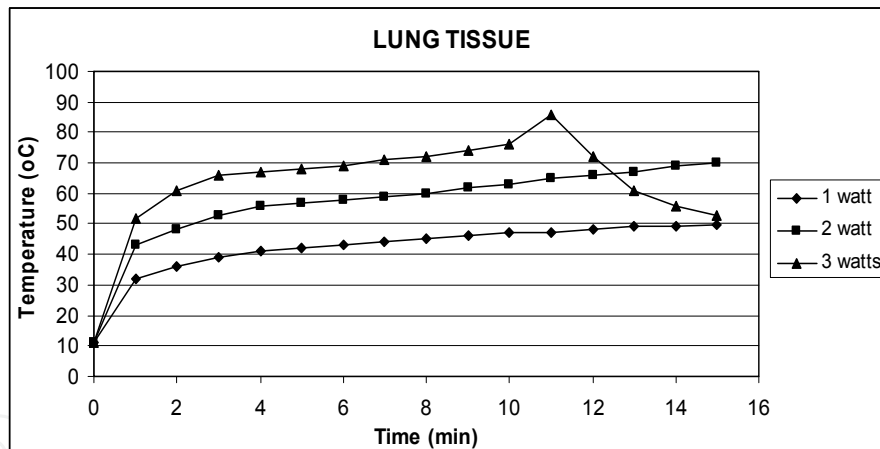

Figure 6. Lung tissue results.

From figure 6, it is seen that, while 1 watt was inadequate for coagulation necrosis in lung tissue, 3 watts showed evidence of carbonization, leading to a drop in temperature as further conduction is inhibited. The best result was achieved with 2 watts, which showed a steady rise in temperature maintained within the ideal ablation temperature range.

The plot in figure 7 shows that, while 2 watts was below the ideal temperature range, and therefore inadequate for effective tissue necrosis, 4 watts was too high and showed evidence of carbonization, resulting in a drop in temperature due to inhibition in conduction. The best result in terms of effective tissue necrosis was achieved with the 3 watts power setting.

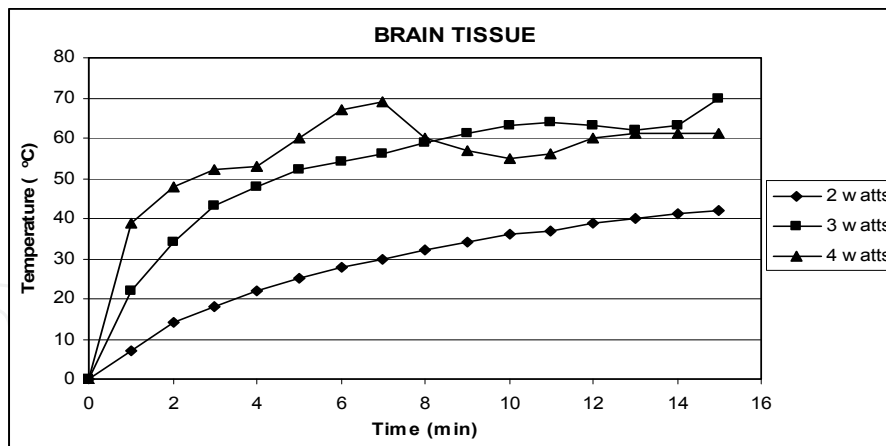

Figure 7. Brain tissue results.

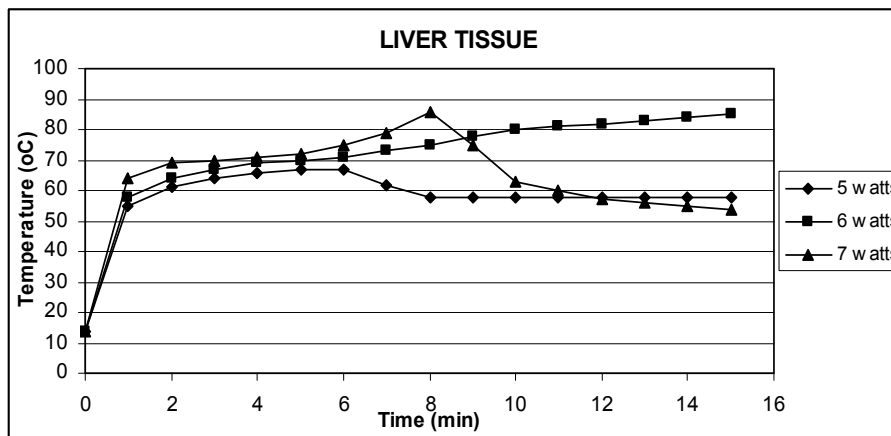

Figure 8. Liver tissue results.

In figure 8, the plot shows that, while 5 watts and 6 watts are within the ideal ablation zone, the 7 watts setting is too high for liver tissue as it produced carbonization resulting in temperature drop. The best result however was recorded with the 6 watts setting which shows a steady rise in temperature without carbonization or charring.

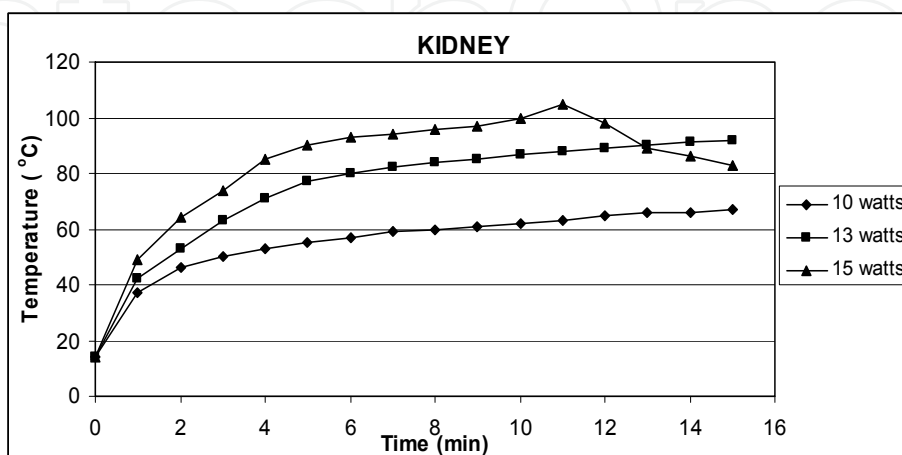

Figure 9. Kidney tissue results.

In figure 9, the results show that 15 watts produced temperature above the ideal ablation range, leading to carbonization and consequently a drop in temperature. Both 10 watts and 13 watts are suitable for ablating kidney tissue as seen, with 13 watts giving the best results since it allows the use of a higher temperature.

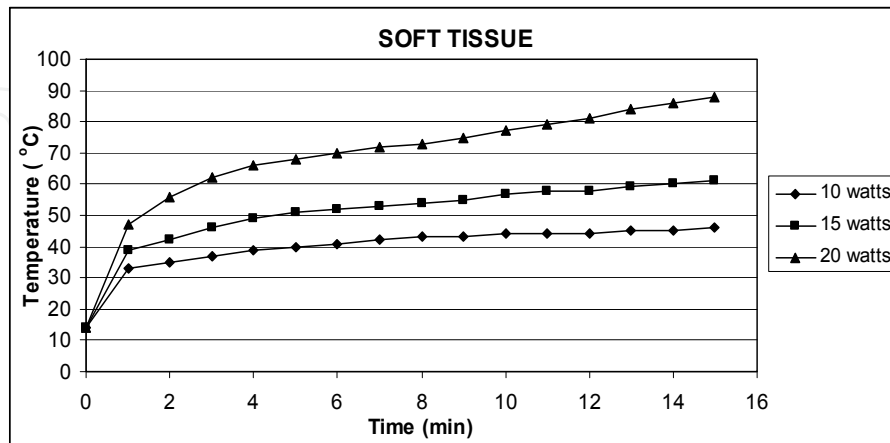

Figure 10. Soft tissue test results.

In figure 10, the results show that, while 15 watts produced temperature within the ideal ablation range, the best result was obtained with the 20 watts power setting since the temperature is higher. This means that the ideal temperature range for treatment will be reached quicker with 20 watts. The 10 watts power setting produces temperature below the ideal range, and was therefore inadequate for ablating soft tissue.

5. Summary of results

The above results have been summarized in table 2 below showing the different tissue types, the best power settings suitable for each tissue type, the minimum and maximum time required to keep the temperature within the ideal ablation range of 50 to 100°C, and the total duration. The total duration is the difference between the maximum time and minimum time.

Tissue Type	Power (w)	Min. Time (min)	Max. Time (min)	Duration (min)
Brain	3.0	4.30	15.0	10.30
Kidney	13.0	1.30	15.0	13.30
Liver	6.0	0.30	15.0	14.30
Lung	2.0	2.30	15.0	12.30
Soft tissue	20.0	1.30	15.0	13.30

Table 1. Summary of results

6. Conclusion

The search for less morbid and less invasive techniques for cancer treatment has led to a strong drive within the global oncology community to develop and implement even more minimally invasive diagnostic and therapeutic procedures. The goals of these minimally invasive therapies for the treatment of cancerous tumours that have made them attractive to both patients and physicians are summarized as:

- Viable and effective treatment options and eradicate in situ local disease
- They are minimally invasive and less traumatic
- Real-time imaging guidance is possible
- Most procedures require only local anaesthesia, and recovery time is faster
- Procedure can be repeated in case of cancer recurrence
- They are safer, with minimal side effects, and limit postoperative morbidities and mortality
- Real-time imaging guidance is possible
- Non-surgical candidates can benefit from these treatment modalities
- They can be performed as an outpatient procedure, or with only a short hospital stay
- Shorten the time to return to daily function and work, and
- Their low-cost make them cheaper and ultimately reduce the overall cost of cancer treatment.

With several ablation techniques available, the ablation characteristics and method of application will differentiate one ablation method from another. Though RF ablation is more widely used, it has its limitations. Most thermo-ablative procedures could be performed in the doctor's office as an outpatient procedure with mild or no sedation. With RF ablation, it requires an increase in temperature to induce necrosis (tissue death). The heat needed for this necrosis requires that large amount of local anaesthetic be infused around the treatment site. This excess fluid blurs the ultrasound visualization of RFA and other heat-based ablation techniques. Though all the available literature agree that thermal ablation therapy is relatively safe and much less traumatic than radical surgical procedures, some complications and side effects have been reported. Some of these complications and side effects have been associated with probe design, probe placement, or the use of multiple probes. The use of both single and multiple probe placements have been described in many studies. Both have their advantages and disadvantages. Though multiple probes appear to be more successful in destroying larger tissue volumes, their use increases the risk of complications in the procedure. Finally, the high cost of RF ablation equipment, coupled with their limited availability has placed these treatment procedures above the reach of most patients and physicians in Sub-Saharan Africa. This project work which aims to investigate the design and development of a minimally invasive thermo-active oncology probe, will narrow this price gap and make treatment more affordable, and readily available to the ordinary patient in Sub-Saharan Africa.

Author details

Timothy A. Okhai

Clinical Engineering Department, Faculty of Engineering and The Built Environment, Tshwane University of Technology, Pretoria, South Africa

Cedric J. Smith

Centurion Academy, Pretoria, South Africa

7. References

- [1] Singleton SE. 2003. "Radiofrequency ablation of breast cancer", *American journal of surgery*, vol. 69, pp. 37-40.
- [2] Cowan BD., Sewell PE., Howard JC., Arriola RM., and Robinette LG. 2002. "Interventional Magnetic Resonance Imaging Cryotherapy of Uterine Fibroid Tumours: Preliminary Observation", *American journal of obstetricians and gynecologists*, vol.186, no. 6, pp. 1183-1187.
- [3] Anonymous. 2002. "Ablation therapy destroys breast cancer without scarring", *Radiological Society of North America*. <http://www.rsna.org/> (Last accessed: 10 June 2008).
- [4] Gage AA. & Baust J, 1998. "Mechanism of tissue injury in cryosurgery", *Cryobiology*, 37:171-186.
- [5] Moore Y., Sofer P., & Ilovich M., 2001. "The science and technology behind cryosurgery. Technical notes, [Online]. Available from: <http://www.galilmedical.com/Prostate/The%20science%20and%20technology%20behind%20cryosurgery.pdf> (Accessed: 10 May 2005).
- [6] Larson TR., Robertson DW., Corica A., & Bostwick DG., 2000. "In vivo interstitial temperature mapping of the human prostate during cryosurgery with correlation to histopathologic outcomes", *Urology*, 55: 547-552.
- [7] Dodd III GD., Soulen MC., Kante RA. et al, 2000. "Minimally invasive treatment of malignant hepatic tumors: At the threshold of a major breakthrough", *Radiographics*, vol. 20, pp. 9-27.
- [8] Bloom KJ., Dowlat K., and Assad L., 2001. "Pathologic changes after interstitial laser therapy of infiltrating breast carcinoma", *American journal of surgery*, vol. 182, pp. 384-388.
- [9] Sabel MS. 2001. "In Situ Ablation of Breast Tumors. What is The State of the Art?", *Cancernews*, [Online], Available from: http://www.cancernews.com/articles/breastcancer_therapies.htm (Last accessed: 19 August 2008).
- [10] Shah A. 2000. "Recent developments in the chemotherapeutic management of colorectal cancer", *BC Medical Journal*, vol. 42, pp. 180-182.

- [11] Gardner RA., Vargas HI., and Block JB. 2002. "Focused microwave phased array thermotherapy for primary breast cancer", *Annals of surgical oncology*, vol. 9, pp. 326-332.
- [12] Ishikawa T., Kohno T., Shibayama T., Fukushima Y, Obi T., Teratani T., Shiina S., Shiratori Y., and Omata M. 2001. "Thoracoscopic thermal ablation for hepatocellular carcinoma located beneath the diaphragm", *Endoscopy*, vol. 33(8), pp. 697-702.
- [13] Ho SG., Munk PL., Legiehn GM., Chung SW., Scudamore CH., and Lee MJ., 2002. "Minimally invasive treatment of colorectal cancer metastasis: Current status and new directions", *BC Medical Journal*, vol. 42, no. 10, pp. 461-464.
- [14] Hynynen K., Pomeroy O., and Smith DN. 2001. "MR Imaging-guided focused ultrasound surgery of fibroadenomas in the breast: a feasibility study", *Radiology*, vol. 219, pp. 176-185.
- [15] Wu F, Wang ZB., Cao YD, Chen WZ, Bai J., Zou JZ., and Zhu H. 2003. "A randomized clinical trial of high-intensity focused ultrasound ablation for the treatment of patients with localized breast cancer", *British journal of cancer*, vol. 89, pp. 2227-2233.
- [16] Wu F., Wang Z., Chen W., Zhu H., Bai J., Zou J., Li K., Jin C., Xie F., and Su H., 2004. "Extracorporeal high intensity focused ultrasound ablation in the treatment of patients with large hepatocellular carcinoma", *Annals of surgical oncology*, vol. 11, pp. 1061-1069.
- [17] Haar GT, and Coussios C, 2007. "High intensity focused ultrasound: Physical principles and devices", *International Journal of Hyperthermia*, Vol. 23, No. 2, pp 89-104.
- [18] Caridi, J. (comp.), "Radio-frequency ablation", University of Florida, Florida, 2004.
- [19] Rhim, H., Goldberg, S.N., Dodd, G.D., Solbiati, L., Lim, K. L., Tonolini, M., & Cho, O.N. 2001. Helping the hepatic surgeon: Essential techniques for successful radio-frequency thermal ablation of malignant hepatic tumours. *Radiographics*, 21:S17-S35. http://radiographics.rsna.org/cgi/content/full/21/suppl_1/S17 (Accessed: 26/07/2005).
- [20] Anonymous, *RadiologyInfo*. http://www.radiologyinfo.org/en/photocat/photos_pc.cfm?image=ri-rfa-devices.jpg&pg=rfa, 2007. (Accessed: 15 September 2008).
- [21] Anonymous, *Boston Scientific Company*. <http://tinyurl.com/d2dbt4e>, 2007. (Accessed: 27 June 2008).
- [22] Dodd III GD., Soulen MC., Kante RA.et al. "Minimally invasive treatment of malignant hepatic tumors: At the threshold of a major breakthrough", *Radiographics*, 2000, vol. 20, pp. 9-27.
- [23] Rhim H., Goldberg SN., Dodd GD, Solbiati L., Lim KL., Tonolini M., and Cho ON. "Helping the hepatic surgeon: Essential techniques for successful radio-frequency thermal ablation of malignant hepatic tumours", *Radiographics*, 2007, vol. 21, pp. S17-S35.
- [24] Goldberg SN., Solbiati L., Gazelle GS., Tanabe KK., Compton CC., and Mueller PR. "Treatment of intrahepatic malignancy with radio-frequency ablation: radiologic-

pathologic correlation in 16 patients" (abstr), *American journal of roentgenology*, 168. [American Roentgen Ray Society 97th Annual Meeting Program Book suppl], 1997, pp. 121.

- [25] Goldberg SN., Gazelle GS., and Mueller PR. "Thermal ablation therapy for focal malignancy. A unified approach to underlying principles, techniques, and diagnostic image guidance", *American journal of roentgenology*, 2000, vol. 174, pp. 323-331.

IntechOpen

IntechOpen