

We are IntechOpen, the world's leading publisher of Open Access books Built by scientists, for scientists

5,400

Open access books available

132,000

International authors and editors

160M

Downloads

Our authors are among the

154

Countries delivered to

TOP 1%

most cited scientists

12.2%

Contributors from top 500 universities



WEB OF SCIENCE™

Selection of our books indexed in the Book Citation Index
in Web of Science™ Core Collection (BKCI)

Interested in publishing with us?
Contact book.department@intechopen.com

Numbers displayed above are based on latest data collected.
For more information visit www.intechopen.com



Hypothesis on the Pathogenesis of Idiopathic Scoliosis

F.H. Wapstra and A.G. Veldhuizen
*University Medical Center of Groningen
The Netherlands*

1. Introduction

Idiopathic scoliosis is a deformity of the torso, characterized by lateral deviation and axial rotation of the spine. Although good anatomic descriptions of the structural changes seen in scoliosis were first made by the ancient Greeks, we have not as yet elucidated its pathogenesis. The deformity always develops from a straight spine into a curved spine, usually accompanied by a rib cage deformity, during the growth period in general and in particular in the rapid growth period. In the growing scoliotic spine, the loss of mechanical stability results in deformation of the vertebral bodies and ribs. The eventual magnitude of an idiopathic scoliotic curve varies and is unpredictable. The extent of the alterations in the shape of the vertebrae and ribs is strongly related to the severity of the scoliotic curve. Pain is a rare symptom, and the patient seems unaware of his or her condition. The idiopathic scoliotic curves follow a geometric pattern: (1) primary thoracic; (2) thoraco-lumbar; (3) primary lumbar (4) double primary. The primary curve invariably has associated secondary curves which follow similar geometric pattern. The axial rotation of the vertebrae is towards the convexity of the curve (Boos & Aebi, 2008). The most important problem related to scoliosis is progression of the deformity, i.e. worsening of the scoliotic curve. The amount of progression is different in each individual patient, some progress very fast, others don't progress at all (Charles et al, 2006; Cheung et al, 2005 & 2006; Dimeglio, 2001; Escalada et al, 2005; Sanders et al, 2007; Wever et al, 2000; Yronen & Ylikoski, 2006). Earlier when the growth velocity of the spine is 20 mm/year or more, the idiopathic scoliosis is nearly always progressive (Cheung et al, 2004). When growth is completed progression generally stops, although research has shown that the risk of curve progression is primarily related to periods of rapid skeletal growth of the patient, most often during the pubertal growth spurt. It was shown that curves of more than 40 degrees Cobb angle are able to progress even after skeletal maturity, because of degeneration of the disk and the fibro-cartilage at load transfer points on the concave side of the curve, although this progression will be at a very low rate of 1° or 2° a year (Duval-Beaupere et al, 1970; Duval-Beaupere & Lamireau, 1985). The prevalence of scoliosis is approximately 4% of the children between 10 and 16 years of age. However, adolescent idiopathic scoliosis does not necessarily progress, and the prevalence of children having a Cobb angle larger than 45 degrees, and therefore needing operative treatment, is approximately 0.1%. Spontaneous improvement is however rare and almost never seen in moderate to large curves. Although many types or causes of scoliosis are known, the idiopathic variety comprises the largest group (80%) and its aetiology remains

unknown. A strong familiar history is usual and a hereditary transmission suggesting an autosomal dominant or multifactorial defect is described (Duthie, 1959; Duval-Beaupere et al, 1970). The effect of industrial environmental factors been investigated, but those factors probably do not significantly influence the prevalence of AIS (Grivas et al, 2008). Some workers favour a neuromuscular basis for the condition, others believe that asymmetrical growth is the primary etiological factor (Deacon et al, 1984 & 1987; Dickson et al, 1984; Duthie, 1959; Millner & Dickson, 1996). Some workers have attributed the initial spinal

deformity of AIS to changes in ribs (Pal, 1991; Burwell et al, 1992; Grivas et al, 1991, 1992, 2002, 2007 & 2008; Sevastik, 2000; Sevastik et al, 2003; Erkula et al, 2003). Many workers hold the view that the rib deformities of progressive AIS are adaptations to forces imposed by the scoliotic spine (Wever et al, 1999; Burwell et al, 2003) with the sternum, held nearly stationary by abdominal ties and providing the opposing forces needed to deform the ribs (Closkey & Schultz, 1993). Whatever factors underlie the aetiology, they ultimately express themselves in the biomechanical changes that define scoliotic curve progression. This paper proposes a possible model for the pathomechanics of idiopathic scoliosis.

2. Neuromuscular factors

Awareness of the position of the body in space is a highly developed sense in humans. It is the result of input from the vestibular, visual and proprioceptive neural pathways. In recent years, strong evidence has been found for the idea that, for visuomotor co-ordination and exploration of space, the brain uses abstract, neural representations of space interposed between sensory input and motor output. These neural representations seem to be organised in nonretinal, body-centred and/or world-centred coordinates (Andersen et al, 1993; Snijder et al, 1993). Spatial information in non-retinal coordinates allows the subject to determine the body position with respect to visual space, which is a necessary prerequisite for accurate behaviour in space. To obtain such a frame of reference, the information coded in coordinates related to the peripheral sensory organs must be transformed and integrated. Defective postural equilibrium has been proposed as a contributing factor in the development of scoliosis (Guyton, 1976). In this regard, defects in visual and vestibular input have been studied extensively as a possible genesis of idiopathic scoliosis (Herman & McEwen, 1979; Herman et al, 1982 & 1985; Sahlstrand et al, 1979; Sahlstrand & Petruson, 1979; Sahlstrand & Lindstrom, 1980; Sahlstrand, 1980; Kapetanios et al, 2002). The occurrence of vestibular-related deficits in AIS patients is well established but it is unclear whether a vestibular pathology is the common cause for the scoliotic syndrome and the gaze/posture deficits or if the latter behavioral deficits are a consequence of the scoliotic deformations. A possible vestibular origin was tested in the frog *Xenopus laevis* by unilateral removal of the labyrinthine end organs at larval stages. After metamorphosis into young adult frogs, X-ray images and three-dimensional reconstructed micro-computer tomographic scans of the skeleton showed deformations similar to those of scoliotic patients. The skeletal distortions consisted of a curvature of the spine in the frontal and sagittal plane, a transverse rotation along the body axis and substantial deformations of all vertebrae (Lambert et al, 2009). A clinical study from Wiener-Vacher (Wiener-Vacher & Mazda, 1998) supports the hypothesis that central otolith vestibular system disorders lead to a vestibule-spinal system imbalance, and may be a factor in the cause of AIS. In a pilot study on scoliotic patients we used Vestibular Evoked Myogenic Potentials (VEMP) (Hain et al, 2006). The purpose of the VEMP test is to determine if the saccule, one portion of the otoliths, as well the inferior

vestibular nerve and central connections, are intact and working normally. The saccule, which is the lower of the two otolithic organs, has a slight sound sensitivity and this can be measured. This sensitivity is thought to be a remnant from the saccule's use as an organ of hearing in lower animals. We found an asymmetry in Idiopathic scoliosis patients and not in other types of scoliosis (unpublished data). Vestibulo-ocular reflex changes may be viewed as a function of asymmetrical control of reflex gain, which is disturbed further during any postural task requiring control of body motion in the presence of visual fixation. Hence, postural instability is ascribed to the conflict between visual and vestibular information within the higher central nervous system (CNS) centres, which can integrate and calibrate converging sensory data for perception and control of postural movement (Herman & McEwen, 1979; Herman et al, 1979 & 1985). Proprioceptive input from joints, ligaments and tendons has been recognised as an integral contribution to the body's postural equilibrium (Guyton, 1976). Defects in the muscle spindle system and tone in the spinal muscles have been implicated in scoliosis (Barrack et al, 1984; Hoogmartens & Basmajian, 1976; Low et al, 1978; Matthews, 1969; Matthews, 1969, Whitecloud et al, 1984; Yekutieli et al, 1981). Neural pathways involving visual, vestibular and proprioceptive afferents all have discrete interconnections in the brainstem. A lesion in this anatomical location could affect all three pathways. Congenital lesions in this area are associated with scoliosis (Tezuka, 1971), and scoliosis has been successfully induced by damaging this area (Dubousset et al, 1982).

Experimentally created defects in the vestibular system of a rat resulted in delayed posture and motor development (Geisler, 1997). Previous studies of CNS function in AIS have suggested that altered cerebral cortical/subcortical function (Herman & McEwen, 1979; Mixon & Steel, 1982; Petersen et al, 1979; Sahlstrand et al, 1979) or hemispherical dominance (Enslin & Chan, 1987) may be related to the aetiology of AIS. Patients with scoliosis and primary alteration of the motor system, so-called neuromuscular scoliosis, are known to have a curve morphology and natural history very different from that of the "typical" idiopathic curve. Magnetic resonance imaging studies of the brain stem in adolescent idiopathic scoliosis by Geissele et al. showed an asymmetry in the ventral pons or medulla in a number of patients (Geissele et al, 1991). Abnormalities in the paraspinal muscles have been implicated by several investigators as a possible causative factor in the production and progression of adolescent idiopathic scoliosis (Fidler et al, 1974; Fidler & Jowett, 1976; Ford et al, 1984; Spenser & Eccles, 1976; Yarom & Robin, 1979). An increased myoelectric response on the convex side of the curve, near its apex, was the main finding reported by various authors (Alexander & Season, 1978; Alexander et al, 1978; Butterworth & James, 1969; Guth & Abbink, 1980; Henssge, 1962; Redford et al, 1969; Spenser & Eccles, 1976; Wong et al, 1980; Yarom & Robin, 1979; Zetterberg et al, 1984), but not all agreed on the meaning of these findings. In early reports a fatigue mechanism was suggested (Riddle & Roaf, 1955), while others explained the difference as an effect of the stretching of the erector spinae muscles on the convex side (Butterworth & James, 1969).

This view was supported by the finding of a stretch reflex (H-reflex) that was more sensitive to vibration and hammer tapping on the spinous processes in larger curves (Hoogmartens & Basmajian, 1976). Others believed that the increased myoelectric activities on the convex side were only a secondary effect of the muscles adapting to a higher load demand in larger curves (Zetterberg et al, 1984). This would be consistent with the reported findings of differences in the morphology of the paravertebral muscles between the left and right sides (Saltin et al, 1977; Spenser & Eccles, 1976; Wong et al, 1980; Yarom & Robin, 1979). However,

the increase of type 1 muscle fibres on the convex side can be explained on the basis of muscle denervation (Ford et al, 1984; Webb, 1973 & 1981; Zetterberg et al, 1984), produced by an alteration of the motor drive arising at the spinal cord level, either from altered sensory input at the same level (Pincott, 1980; Pincott & Taffs, 1982; Taffs et al, 1979) or from a central mechanism (Barrack et al, 1984; Dubousset et al, 1982; Michelsson, 1965; Sahlstrand et al, 1979; Whitecloud et al, 1984). The ocular and postural control systems reach maturation in early adult life (Forsberg & Nasher, 1982; Nasher, 1982; Sharp et al, 1979).

Children with idiopathic scoliosis in the age range of 9–16 years exhibit delay in the complete development of smooth pursuit and optokinetic nystagmus; moreover, they demonstrate a delay in tasks that couple the vestibular and visual systems, particularly those requiring voluntary suppression of the vestibulo-ocular reflex (Herman & McEwen, 1979). This behaviour is required to ensure optimal visual acuity in phase with head motion. Incomplete maturation of visual and visuo-vestibular functioning is ascribed to inefficient extraretinal processing of perceptual information by cortical structures within the CNS, e.g. to delayed development of perception of the position of visual images in space (Herman & McEwen, 1979; Sharp & Rabinovitch, 1979; Yasui & Young, 1976; Young, 1977). The maturation of the ocular and postural control systems coincides with the secondary rapid growth period. Some workers believe that not only the somatic nervous system is involved but the autonomic nervous system as well (Burwell, 2003; Grivas et al, 2009; Burwell et al, 2009). AIS in girls may then be the result from developmental disharmony expressed in spine and trunk between autonomic and somatic nervous systems. The autonomic component involves *selectively increased sensitivity* of the hypothalamus to circulating leptin (genetically-determined up-regulation possibly involving inhibitory or sensitizing intracellular molecules, such as SOC3, PTP-1B and SH2B1 respectively), with asymmetry as an adverse response (hormesis); this asymmetry is routed bilaterally via the sympathetic nervous system to the growing axial skeleton where it may initiate the scoliosis deformity.

We propose, therefore, that the most likely cause of idiopathic scoliosis includes a neuromuscular condition and an asymmetry of the transversospinalis muscles, produced by alteration of the motor drive at the spinal cord level, either from altered sensory input at the same level or from a central mechanism, which may produce enough lateral deviation and axial rotation to disturb the delicate balance of forces in the region, thereby producing an idiopathic scoliosis. Growth disturbance may not be a primary cause of idiopathic scoliosis, but it certainly plays a prominent part in the progression of this deformity, although it is not very clear how.

2.1 Spinal growth factor

Researchers of spinal deformity have always been interested in spinal growth and its relationship to spinal curvature. Normal longitudinal growth does not proceed in a uniform, linear pattern (Tanner, 1962 & 1978; Tanner & Davies, 1985; Tanner et al, 1965). There are two periods of rapid growth, the first from birth to three years of age, and the second during the adolescent growth spurt. The intervening period is a period of quiet but steady growth. For over 100 years the association between idiopathic scoliosis and vertebral growth has been debated (Anderson et al, 1965; Burwell & Dangerfield, 1974; Calvo, 1957; Duthie, 1959; Duval-Beaupere et al, 1970; Duval-Beaupere & Lamireau, 1985). A large number of studies on growth differences between normal and scoliotic girls have been conducted.

Unfortunately, the results of these studies were not consistent. Willner observed a taller mean standing height in girls with scoliosis compared to healthy controls (Willner, 1974 & 1975 & 1975). These findings were supported by other cross-sectional studies (Buric & Momcilovic, 1982; Hagglund et al, 1992; Leong et al, 1982; Low et al, 1978; Nordwall & Willner, 1975; Normelli et al, 1985; Shohat et al, 1988). Loncar-Dusek et al. demonstrated a higher peak velocity for scoliotic children (Loncar-Dusek, 1991). Moreover, Goldberg et al. and Ylikowski et al. reported that girls with adolescent idiopathic scoliosis (AIS) have an earlier growth spurt and earlier attainment of adult height compared to healthy nonscoliotic controls (Goldberg et al, 1993; Ylikowski, 1993). This is in marked contrast to many other reports, which found no difference in growth pattern or height between AIS patients and nonscoliotic controls (Drummond & Rogala, 1980; Taylor, 1983; Veldhuizen, 1985; Veldhuizen et al, 1986). However, one should keep in mind that most of the studies on growth differences between scoliotic and nonscoliotic girls mentioned above were based either on length measurements of the sitting height, without correction for the error introduced by the scoliotic deformity itself, or were corrected using the method described by Bjure (Bjure et al, 1968) This method overestimates the real length of the spine, and may not be valid for curves of 30° or less Cobb angle, since they had no patients with such mild curves in their material (Skogland & Miller, 1981). The advocates of a deviating growth pattern explain the initiation of idiopathic scoliosis as the result of a greater tendency of taller and more slender spines to buckle out of the sagittal plane under loading (Dickson et al, 1984 & 1987; Millner & Dickson, 1996; Smith & Dickson, 1987).

Roaf (Roaf, 1960 & 1966) and Dickson (Dickson et al, 1984 & 1987) explain the pathogenesis of idiopathic scoliosis as a result of biplane asymmetry. Increased anterior vertebral height at the apex of the curve with posterior end-plate irregularity characterises the median plane asymmetry. This lordosis at bony level was an important basis for their theory that thoracic lordosis, which is caused by a relative overgrowth of the anterior part of the vertebral body, triggers the initiation of scoliosis by buckling. In a three-dimensionally rendered CT scan study we have previously described the vertebral and rib deformities in idiopathic scoliosis (Wever et al, 1999). The observed vertebral deformities suggest that these are caused by bone remodelling due to an imbalance between forces in the anterior and posterior spinal column (Meyer, 1866; Wever et al, 1999). In our study, we also noted a minimal wedge deformation in the local sagittal plane in certain apical vertebrae, as mentioned by Deacon and Dickson, but it is questionable whether this deformation in the sagittal plane is a primary aetiological phenomenon, as they suggest, or whether it is rather a secondary phenomenon, comparable to the other vertebral deformations. They do not offer an explanation for this growth disturbance. Deane and Duthie (Deane & Duthie, 1973; Duthie, 1959) found in a cadaveric study that the anterior body lengths either singly, or as total length were almost normal in the scoliotic patients, but the posterior lengths were considerably reduced due to a strong inhibitory force to growth of the posterior vertebral structures. Furthermore, no proof of the "Euler theory", that idiopathic scoliosis is the result of buckling under load, has ever been given. The mechanical behaviour of such a complex and highly non-linear structure as the human vertebral column is very difficult to analyse. Using a new finite element model of the spine, we have previously examined this buckling theory (van de Plaats, 1997; van de Plaats et al, 2007). Judging from the results of this finite element study, buckling can not initiate idiopathic scoliosis, because the characteristic coupling of lateral deviation and axial rotation is absent. Furthermore, no difference in

spinal flexibility can be established between patients with idiopathic scoliosis and controls (Mattson et al, 1983; Veldhuizen, 1985; Veldhuizen & Scholten, 1990). Mechanical and computer models of the spine are frequently used to analyse the mechanisms by which scoliosis is initiated and aggravated. In a relatively simple stable physical model of the trunk, progression of the scoliosis due to growth can be shown (Murray & Bulstrode, 1996; Nijebanning, 1998), but there is little evidence that growth initiate idiopathic scoliosis.

The question is what growth is.

2.2 Human growth

Growth is inextricably associated with life. It is defined as a quantitative increase in size or mass, and it is a consequence of hyperplasia and hypertrophy; i.e. the size of the cells increases, as well as the number of cells. The term 'growth' is generally used for an increase in height or weight. Several body length dimensions can be measured, like total body height, sitting height, arm span, foot length, head circumference etc. Leg length is calculated by protraction of sitting height from total height. The increase in length is calculated per year, this is called the growth velocity. Unfortunately, in literature several terms are used alternatively, like growth, growth velocity, height velocity, or growth rate. Often timing or the magnitude of the growth spurt is simply indicated as peak growth velocity (PGV). Furthermore, many authors just refer to peak growth velocity of total body height as peak height velocity. It is often confusing whether the magnitude of the growth velocity is meant, or the age at which the maximum growth velocity takes place. In this article the term 'growth' is used for the increase in a certain length dimension in centimetres. The term 'growth velocity' is used for the increase of a certain length dimension per year, expressed in cm/year. The term 'peak growth velocity (PGV)' of a certain length dimension is used for the maximum growth velocity during adolescence. For example, PGV of total body height, or PGV of foot length. Growth is a volumetric revolution. From birth onwards, total body height increases 350% and weight increases 20-fold. Growth involves changes in proportion. At birth, the lower limbs make up 30% of the total body height in contrast to 48% at skeletal maturity. The infant head makes up 25% of the total body height and only 13% at skeletal maturity. All the changes in body length dimensions are gradual and each dimension has its own period of rapid growth (Busscher et al, 2010 & 2011; Dimeglio, 2001). Tanner (Tanner, 1962 & 1978) was the first to describe the distal-to-proximal growth gradient theory. This theory states that humans grow "from the outside to the inside", in other words, distal body parts will have their growth spurt earlier in adolescence in comparison to more proximal body parts. Four main characteristics dominate puberty: an increase in total body height, change of upper and lower body segment proportions, change in overall morphology, and the development of secondary sexual characteristics. Wide individual variations exist in onset and duration of puberty, and many factors play a role in the timing of the pubertal growth spurt. Beyond the age of 10 years, the growth patterns of boys and girls diverge. This is mainly due to the fact that boys have their pubertal growth spurt later in adolescence. The average age for the pubertal growth spurt, or the peak growth velocity of total body height, to occur is between ages 10 and 14 in 95% of the girls and between ages 12 and 16 in 95% of the boys (Gerver & de Bruin, 2001 & 2003; Tanner & Davies, 1985), see Figure 1A.

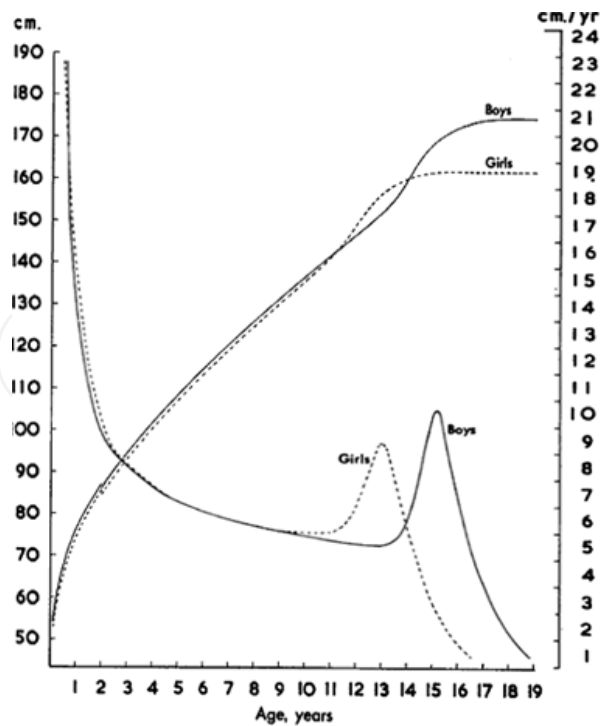

Fig. 1A. Average growth curves and growth velocity curves of boys and girls.

Furthermore, it is known that the magnitude of the peak growth velocity is significantly larger for those individuals with an early pubertal growth spurt as compared to those with a late growth spurt (Figure 1B). However, the growth period before the peak is longer and therefore the ultimate total body height will be similar or higher compared to children with an early growth spurt (Gerver & de Bruin, 2003; Tanner & Davies, 1985)

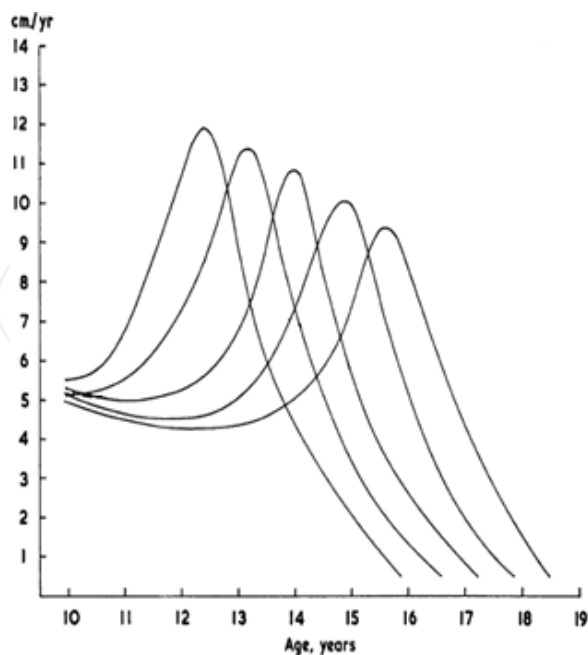

Fig. 1B. Examples of growth velocity curves of children having their peak growth velocity at a different age.

Generally, the increase in height of the vertebral bodies is the result of enchondral growth at the upper and lower growth plate (Bick, 1961; Gooding & Neuhauser, 1965; Knuttson, 1961), whereas the increase in width is a result of periosteal growth (Bick, 1961). It has been suggested (Neugebauer, 1976) that the regulating (hormonal) mechanism is different for the two types of bone growth, but there is in fact little definite evidence for the endocrine pathways by which any particular hormone influences skeletal growth (Sisson, 1971). The growth of the posterior elements (lamina, pedicles) comes in part from enchondral ossification initiated in the articular cartilages of the articular processes (Enneking & Harrington, 1969). Growth can also be described as a mechanical process.

2.3 Growth as a mechanical process

In his classic "On Growth and Form" D'Arcy Thompson (D'Arcy Wentworth Thompson, 1961) analyses biological processes in their mathematical and physical aspects. In his opinion the form and change of any object in its movement and its growth may be described as due to the action of forces. In the Newtonian language of elementary physics, force is recognised by its action in producing or changing motion or in preventing change of motion or in maintaining rest. In accordance with D'Arcy Thompson's view we describe growth as a mechanical process; a process that elapses in time and can be described by mechanical input and output variables. All parts of the skeleton show visco-elastic behaviour, meaning that a change in form is the sum of the changes in elastic and viscous transformations. The main difference between elastic and viscous transformation is time response. Elastic transformation can be understood as the action of a spring: by putting a weight on a spring, the length of that spring will increase immediately and after removing this weight, it regains its original length (Figure 2A). Viscous transformation can be understood as the action of a damper: by putting a weight on a damper, at first nothing will happen, but after a while the damper will move. After removing this weight, the damper will remain in its new position. (Figure 2B)

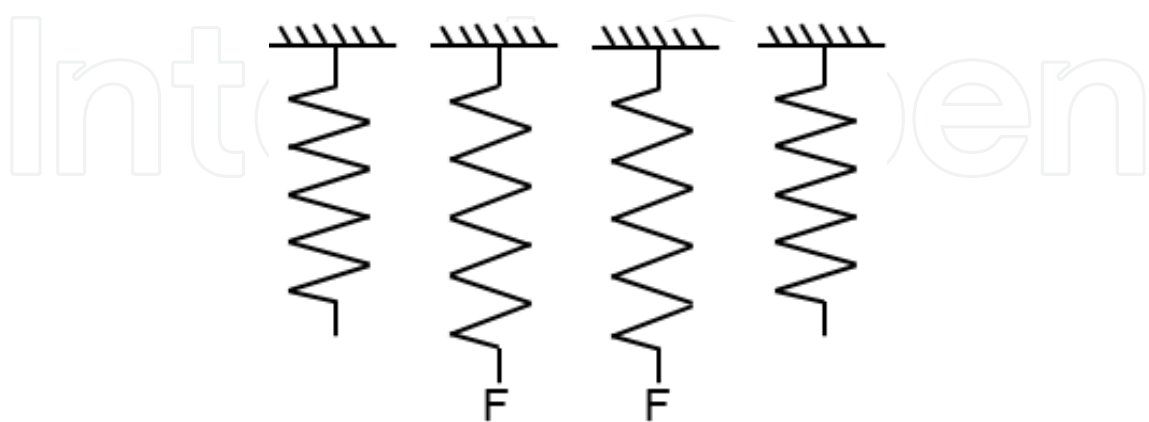

Fig. 2A. Elastic Element.

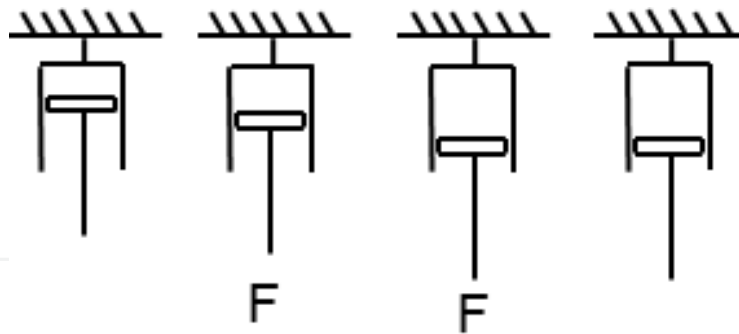

Fig. 2B. Viscous Element.

The growth in bone takes place in the growth-plate. As shown in figure 3 the genesis of growth can be thought of as a hydraulic system: the barrel left in the drawing contains liquid under pressure, representing the nursery-room of new cells. The liquid flows through tubes in which switch-back valves are incorporated to form a piston-cylinder combination. The liquid pressure will move the piston. Every piston-cylinder combination represents a growing cell and will produce an internal force on the growth-plate. The pistons are mechanically coupled resulting in a total force on the growth-plate, called the force of growth. The displacement of the coupling beam models the increase in length. Unequal distribution of force on the coupling beam results in an inclination of the coupling beam, simulating asymmetric growth. The switch-back valve supports the permanent character of the transformation by growth.

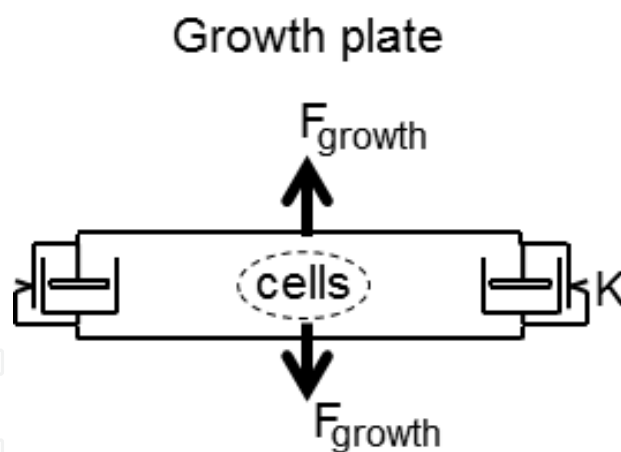

Fig. 3. Genesis of growth, represented as a hydraulic system. The switch-back valve (K) supports the permanent character of the transformation by growth.

If bone grows the soft tissues like muscles and ligaments have to follow and increase their length as well against their own tractive powers. This force is referred to as Soft tissue Complex Force and opposes growth. As shown in figure 4 this Soft Tissue Complex Force will induce a suction tension through traction on the piston. If the suction force is larger than the spring-force on the switch-back valve, liquid will flow into the cylinder. The lengthening will be permanent through the action of the switch-back valve. Only one piston-cylinder combination has been drawn, representing the total of growing cells.

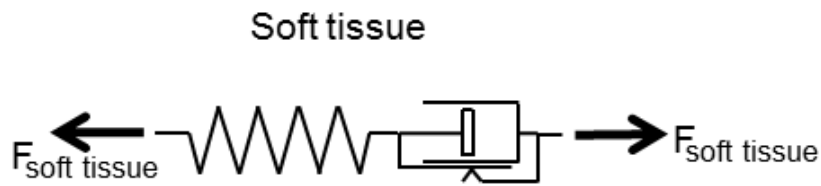

Fig. 4. Hydraulic representation of traction Force: $F_{\text{Soft Tissue Complex}}$.

In figure 5 a scheme of the growth-process of bone-soft tissue combination is presented. The in the growth-plate generated Force of Growth will induce growth in bone but will be inhibited by the Force of Soft Tissue Complex, required for lengthening of soft tissue.

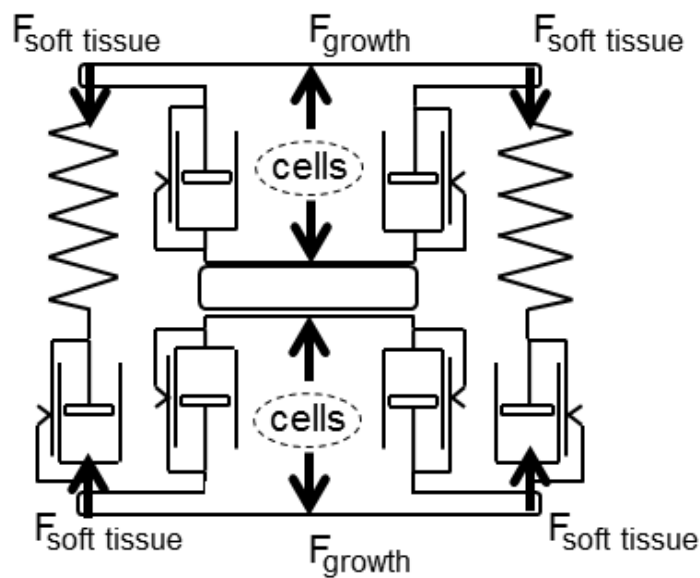

Fig. 5. A scheme of growth process of bone and soft tissue is presented.

The difference between these two forces creates a growth-velocity in bone resulting in growth only if there is a positive force difference. This mechanical concept of growth explains easily the greater length of bony elements in Marfan Disease: the force of soft tissue complex will be smaller and will have a less opposing effect on the force of growth.

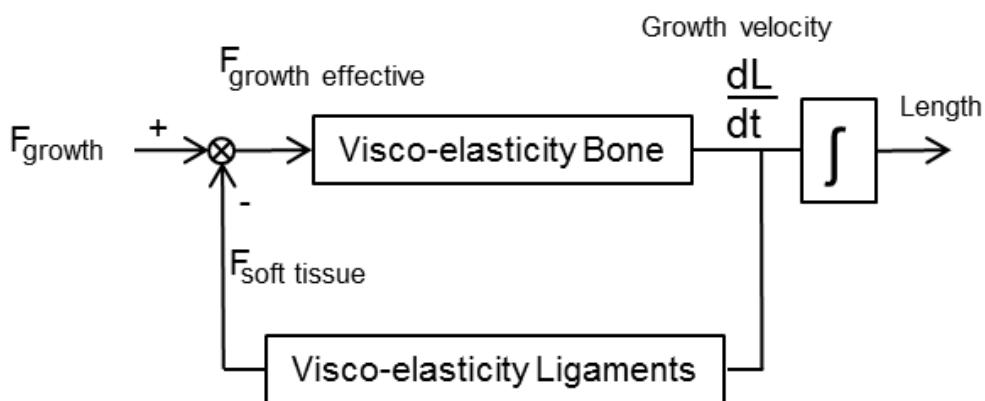

Fig. 6. Growth-process.

In table 1 a summary of forces acting on the spine are given. For the growth process only the Force of Growth and the Force of Soft Tissue Complex are important. The other forces, mentioned in table 1, act relatively too shortly to influence the slow reacting viscous elements.

Forces	Duration of Action	Effect
Gravity	Long	Viscous
Ligaments/muscles passive	Short	
Muscles active	Short	
External load	Short	
Growth	Long	Viscous

Table 1. Summary of forces, acting on the spine.

Our basic model of growth shows a one- dimensional situation: bone-growth equals soft tissue lengthening. In practice the soft tissue will show a non-linear and dynamic behaviour. The introduction of a joint makes the system multi-dimensional and enables small rotation of skeletal parts as a result of growth. Sometimes these small rotations are part of nature's plan, e.g. when considering the formation of the s-shape in the sagittal plane during the first years of life.

3. Curve progression

The initiation of idiopathic scoliosis can be explained on the basis of a neuromuscular condition. However, the proposed neurological defects are not correlated with the degree of subsequent progression for the curve. According to Perdriolle (Perdriolle et al, 1993) the progression of idiopathic scoliosis is the result of a mechanical phenomenon. It has been demonstrated that the expected spinal growth at the moment that the initial curve is diagnosed is of crucial importance for the further development of scoliosis (Lonstein & Carlson, 1984). In a recent study, we demonstrated that progression of an idiopathic scoliotic curve correlates with periods of moderate and rapid growth, measured on successive radiographs (Wever et al, 2000). The variations in growth speed across individuals, as seen in our study, may explain the variations in expression of AIS, together with other factors such as the type of curve. Different biomechanical mechanisms are given to explain scoliosis progression during spinal growth (Kamman, 2003; Pincott & Taffs, 1982; van de Plaats, 1997; van de Plaats et al, 2007; Raso, 1998). It has been suggested that asymmetrical growth of the apical vertebral bodies due to chronic axial asymmetrical loading on the physes, according to the Hueter- Volkmann law, may result in scoliosis progression (Agadir et al, 1988; Perdriolle et al, 1993). Stokes et al. quantified the relationship between the degree of a symmetrical loading and the degree of asymmetrical growth in a rat-tail model and confirmed that vertebral wedging results from asymmetric growth in the physes (Stokes et al, 1996). In our study, there was a strong correlation between the degrees of apical vertebral deformation (wedging) and the degree of lateral deviation (Cobb angle), meaning that more vertebral deformation was found in more severe curves (Wever et al, 1999 & 2000). However, we have not found a direct relation between curve progression and an increase in wedging in progressive scoliosis. Others have stressed the importance of the posterior musculo-ligamentous structures of the spinal column, which have a strong tendency to

shorten. It was postulated that the tethering tendency of the musculo-ligamentous structures of the posterior compared to the rapid growth of the anterior spinal column will result in curve progression and the complex geometry of scoliosis (Murray & Bulstrode, 1996; Roaf, 1960 & 1966; Somerville, 1952). Several major sensory systems, the general proprioceptors and the special receptors of the vestibular, visual, auditory and olfactory systems, are believed to be the principal sensors. Lack of feedback, inappropriate feedback, or faulty programming within the CNS, due to pathology, results in varying degrees of abnormal muscle tone, movement, and / or problems associated with gravity and orientation in space. The postural tone depends largely on the stretch reflex in the extensor muscles (Matthews, 1969; Michelsson, 1965). This reflex acts so that any external factor that brings the body out of equilibrium will stretch the appropriate extensor muscles and their muscle spindles, thereby activating the primary afferents, which monosynaptically excite homonymous alpha afferents. The latter will induce a contraction in the stretched muscles and restore the body to its position of equilibrium. The sensitivity of muscle spindle afferents is known to be under control of supraspinal centres, which act through the supraspinal gamma route and through the gamma motor neurons at the spinal level. The gamma motor neurons innervate the muscle spindles, which are sensitive to stretch in a minor or major degree, according to whether they are more or less biased by the gamma motor neurons. The central parts of the muscle spindle are surrounded by primary and secondary afferent fibres, transmitting stretch information to the alpha motor neurons in the anterior horns and to higher centres. The sensory input from the muscle spindle depends on the amount of stretch and the amount of gamma bias. Recently, it has been shown that in human intervertebral discs and longitudinal ligaments mechanoreceptors are present and it is more than likely that this will be also the case in the other ligaments of the spine. As mentioned in previous paragraph growth (Force of Growth) will stretch the soft tissues (Force of Soft Tissue Complex) and this will lead through a dysfunction of the muscle spindle system to asymmetric muscle contraction resulting in an increase of the scoliosis, meaning the higher Force of Growth (i.e. more growth) and the more dysfunction of the mechanoreceptors the greater the scoliosis. Only a dysfunction of the mechanoreceptors and no growth will not lead to a serious scoliosis. The various degrees of scoliosis seen clinically depend on the growth velocity and the degree of malfunctioning of the mechanoreceptors. A failure of the supportive musculo-ligamentous structures and/or their neuromuscular control system for stabilizing the spine may explain the occurrence of progression in AIS. Lack of feedback, inappropriate feedback, or faulty programming within the CNS, due to pathology, may be an important contributing factor in curve progression (Dobosiewicz, 1997).

4. Summary

The natural history of AIS involves an initial stage in which a small curve develops due to a small defect in the neuromuscular control system and a second stage, during adolescent growth, in which the scoliotic curve is exacerbated by biomechanical factors, whereas neurological dysfunction may play a role in the extent of progression during normal growth (Dobosiewicz, 1997). We propose that the most likely cause of idiopathic scoliosis is neuromuscular. Asymmetry of the transversospinalis muscles may produce enough lateral deviation and axial rotation to disturb the delicate balance of forces in the region, thus producing a scoliotic deformity. This asymmetry of the transversospinalis muscles may be

produced by alteration of the motor drive arising at the spinal cord level, either from altered sensory input at the same level or from a central mechanism, and “the altered muscle pull” is the final common pathway for the production of a scoliotic curve. Growth (Force of Growth) will stretch the soft tissues (Force of Soft Tissue Complex) and this will lead through a dysfunction of the muscle spindle system to asymmetric muscle contraction resulting in an increase of the scoliosis, meaning the higher Force of Growth (i.e. more growth) and the more dysfunction of the mechanoreceptors the greater the scoliosis. Only a dysfunction of the mechanoreceptors and no growth will not lead to a serious scoliosis. The various degrees of scoliosis seen clinically depend on the growth velocity and the degree of malfunctioning of the mechanoreceptors. Secondary to the scoliosis, a force system arises which may be held responsible for the geometrical and morphological characteristics of adolescent idiopathic scoliosis (Pincott & Taffs, 1980; Wever et al, 1999).

5. References

- Agadir, M; Sevastik, J; Persson, A & Isberg, B (1988) Induction of scoliosis in growing rabbits by unilateral growth stimulation. *Spine* 13: 1065- 1969
- Alexander, MA & Season, EH (1978) Idiopathic scoliosis. *Arch Phys Med Rehabil* 59:314-315
- Alexander, MA; Bunch, WH & Ebbesson, SOE (1978) Can experimental dorsal rhizotomy produce scoliosis? *J Bone Joint Surg Am* 54:1509-1513
- Andersen, RA; Snijder, LH; Li, CS & Stricane B (1993) Coordinate transformations in the representation of spatial information. *Curr Opin Neurobiol* 3: 171-176
- Anderson, M; Shih-Chen Hwang, AM & Green WT (1965) Growth of the normal trunk in boys and girls during the second decade of life, related to age, maturity, and ossification of the iliac epiphysis. *J. Bone Joint Surg. Am* 47: 1554-1564
- Arkin, AM (1949) The mechanism of the structural changes in scoliosis. *J Bone Joint Surg Am* 31: 519-528
- Barrack, RL; Whitecloud, TS; Burke, SW; Cook, SD & Harding, AF (1984) Proprioception in idiopathic scoliosis. *Spine* 9:681-685
- Bick, E (1961) Vertebral growth. Its relation to spinal abnormalities in children. *Clin.orthop* 21: 43-48
- Bjure, J; Grimby, G & Nachemson, A (1968) Correction of the body height in predicting spirometric values in scoliotic patients. *Scand J Clin Lab Invest* 21:189-192
- Boos, N & Aebi, M (2008) *Spinal disorders: fundamentals of diagnosis and treatment*.
- Buric, M & Momcilovic, B (1982) Growth pattern and skeletal age in school girls with idiopathic scoliosis. *Clin Orthop* 170:238-242
- Burwell, RG & Dangerfield PH (1974) In: Zorab PA (ed) *Scoliosis*. Proceedings of the Fifth Symposium. Academic Press, pp 123-163
- Burwell, RG & Dangerfield, P H (1992). Pathogenesis and assessment of scoliosis. In: G. Findlay and R. Owen (editors) *Surgery of the Spine. A Combined Orthopaedic and Neurosurgical Approach, Volume 1* (Oxford: Blackwell Scientific Publications), Chapter 19, pp. 365-408
- Burwell, RG; Cole, AA & Grivas, TB (1992) Screening, aetiology and the Nottingham theory for idiopathic scoliosis. In: A. Alberti, B. Drerup and E. Hierholzer (editors) *Sixth International Symposium on Surface Topography and Spinal Deformity* (Stuttgart: Gustav Fischer), pp. 136-161

- Burwell, RG; Cole, AA; Cook, TA; Grivas, TB; Kiel, AW; Moulton, A; Thirlwall, AS; Upadhyay, SS, Webb, JK; & Wemyss-Holden, SA (1992). Pathogenesis of idiopathic scoliosis. The Nottingham Concept. *Acta Orthop Belg.* 58 Suppl 1:33-58
- Burwell, RG; Aujla, R K & Cole, AA (2003) Relation of ribs to the spine in the transverse plane at the curve apex in preoperative adolescent idiopathic scoliosis (AIS): evaluation using an ultrasound method and radiographs. In: Proceedings of the British Scoliosis Society, Leeds, 9-11 April. *J of Bone & Joint Surg.*, vol. 86-B. pp 112
- Burwell, RG (2003) Aetiology of idiopathic scoliosis: current concepts. *Pediatr Rehabil.* Jul-Dec; 6 (3-4):137-70
- Burwell, RG; Aujla, RK; Grevitt, MP; Dangerfield, PH; Moulton, A; Randell, TL & Anderson, SI (2009) Pathogenesis of adolescent idiopathic scoliosis in girls - a double neuro-osseous theory involving disharmony between two nervous systems, somatic and autonomic expressed in the spine and trunk: possible dependency on sympathetic nervous system and hormones with implications for medical therapy. *Scoliosis.* Oct 31; 4:24
- Busscher, I; Wapstra, FH & Veldhuizen, AG (2010) Predicting growth and curve progression in the individual patient with adolescent idiopathic scoliosis: design of a prospective longitudinal cohort study. *BMC Musculoskeletal Disease* 11:93 11-93, 1-21
- Busscher, I; Gerver, WJM; Kingma, I; Wapstra, FH; Verkerke, GJ & Veldhuizen, AG (2011) The growth of different body length dimensions is not predictive for the peak growth velocity of sitting height in the individual child *Eur Spine J* 20:791-797
- Busscher, I; Kingma, I; Wapstra, FH; Bulstra, SK; Verkerke, GJ & Veldhuizen, AG (2011) The value of shoe size for prediction of the timing of the pubertal growth spurt. *Scoliosis* 2011, 6:1, 1-7
- Busscher, I; Kingma, I; Wapstra, FH; de Bruin, R; Verkerke, GJ & Veldhuizen, AG (2011) Predicting the peak growth velocity in the individual child: validation of a new growth model *Eur Spine J* DOI 10.1007/s00586-011-1845-z
- Butterworth, TR & James, C (1969) Electromyographic studies in idiopathic scoliosis. *South Med J* 62: 1008-1010
- Calvo, IJ (1957) Observations on the growth of the female adolescent spine and its relation to scoliosis. *Clin Orthop.* 10:40-46
- Charles, YP; Daures, JP & de Rosa, V (2006) Progression risk of idiopathic juvenile scoliosis during pubertal growth. *Spine*; 31:1933-42.
- Cheung, J; Veldhuizen, AG; Halbertsma, JP; Maurits, NM; Cool, JC & van Horn, JR (2004) The relation between electromyography and growth velocity of the spine in the evaluation of curve progression in idiopathic scoliosis. *Spine*; 29:1011-6.
- Cheung J; Veldhuizen, AG; Halbertsma, JP; Maurits, NM; Cool, JC & van Horn, JR (2005) A preliminary study on electromyographic analysis of the paraspinal musculature in idiopathic scoliosis. *Euro Spine J*: 14, 130-137
- Cheung, J; Veldhuizen, AG; Halbertsma, JPK; Sluiter, WJ & van Horn, JR (2006) Geometric and Electromyographic Assessment in the Evaluation of Curve Progression In Idiopathic Scoliosis. *Spine*: vol.31, 322-329
- Closkey, R F & Schultz, AB (1993). Ribcage deformities in scoliosis: spine morphology, rib cage stiffness, and tomography imaging. *J of Orthopedic Research*, 11: 730-737
- D'Arcy Wentworth Thompson (1961) *On Growth and Form*. Cambridge University Press ISBN 0521 437768

- Deacon, P; Flood, BM & Dickson, RA (1984) Idiopathic scoliosis in three dimensions. A radiographic and morphometric analysis. *J Bone Joint Surg Br* 66:509-512
- Deacon, P; Archer, IA & Dickson, RA (1987) The anatomy of spinal deformity: a biomechanical analysis. *Clin Orthop* 10:897-903
- Deane, G & Duthie, RB (1973) A new projectional look at articulated scoliotic spines. *Acta Orthop Scand* 44: 351-365
- Dickson, RA; Lawton, JO; Archer, IA & Butt, WP (1984). The pathogenesis of idiopathic scoliosis. Biplanar spinal asymmetry. *J Bone Joint Surg Br* 66: 8-15
- Dickson, RA & Deacon, P (1987) Spinal growth. *J Bone Joint Surg Br* 69: 690- 692
- Dimeglio, A (2001) Growth in pediatric orthopaedics. *J.Pediatr.Orthop*: 21: 549-55
- Dobosiewicz, K (1997) Neurophysiological mechanism of the unloading reflex as a prognostic factor in the early stages of idiopathic scoliosis. *Eur Spine J* 6:93-97
- Drummond, DS & Rogala, EJ (1980) Growth and maturation of adolescents with idiopathic scoliosis. *Spine* 5: 507-511
- Dubousset, J; Queneau, P & Thillard, MM (1982) Experimental scoliosis induced by pineal and diencephalic lesions in young chickens: its relation with clinical findings in idiopathic scoliosis. Proceedings of the 17th Annual Scoliosis Research Society Meeting, Denver, Colorado
- Duthie, RB (1959) The significance of growth in orthopaedic surgery. *Clin Orthop* 14:7-19
- Duval-Beaupere, G; Dubousset, J; Queneau, P & Grossiord, S (1970) Pour une théorie unique de l'évolution des scolioses. *Press Med* 78:1141-1146
- Duval-Beaupere, G & Lamireau, T (1985) Properties at less than 30 degrees. Properties of the Evolutivity (risk of progression). *Spine* 5:421- 424
- Enneking, WF & Harrington, P (1969) Pathological changes in scoliosis. *J Bone & Joint Surg. Br* 51: 165-184
- Enslein, K & Chan, DP (1987) Multiparameter pilot study of adolescent idiopathic scoliosis. *Spine* 12:978-982
- Erkula, G; Sponseller, PD & Kiter, AE (2003) Rib deformity in scoliosis. *European Spine Journal*, 12: 281-287
- Escalada, F; Marco, E & Duarte, E (2005) Growth and curve stabilization in girls with adolescent idiopathic scoliosis. *Spine* 30: 411-417.
- Fidler, MW; Jowett, RL & Troup, JDG. (1974) Histochemical study of the function of multivividus in scoliosis. In: Zorab PA (ed) *Scoliosis and muscle*. William Heinemann, London, 184-192
- Fidler, MW & Jowett, RL (1976) Muscle imbalance in the etiology of scoliosis. *J Bone Joint Surg Br* 58:200-201
- Ford, DM; Bagnall, KM; McFadden, KD; Greenhill, BJ & Rasco, VJ (1984) Paraspinal muscle imbalance in adolescent idiopathic scoliosis. *Spine* 9: 373-376
- Forsberg, H & Nasher, LM (1982) Ontogenetic development of postural control in man. Adaptation to altered support in visual conditions during stance. *J Neurosci* 2:545-552
- Geisler, HC (1997) The influence of the vestibular system on the development of posture in the rat. Thesis, University of Groningen
- Geissele, AE; Mark, LTC; Kransdorf, J; Geyer, CA; Jelinek, JS; Bruce, LTC & Van Dam E (1991) Magnetic resonance imaging of the brain stem in adolescent idiopathic scoliosis. *Spine* 16:761-763

- Gerver, WJ & de Bruin, R (2001) Paediatric morphometrics: a reference manual. Second extended edition ed. UPM Maastricht
- Gerver, WJ & de Bruin, R (2003) Growth velocity: a presentation of reference values in Dutch children. *Horm.Res*; 60:181-184
- Gooding, CA & Neuhauser, EBD (1965) Growth and development of the vertebral body in the presence and absence of normal stress. *Am J Roentgenol*: 93, 338-394
- Goldberg, CJ; Dowling, FE & Fogarty, EE (1993) Adolescent idiopathic scoliosis: early menarche, normal growth. *Spine* 18:529-535
- Grivas, TB ; Burwell, RG & Purdue, M (1991) A segmental analysis of thoracic shape in chest radiographs of children. Changes related to spinal level, age, sex, side and significance for lung growth and scoliosis. *Journal of Anatomy*, 178: 21-38,
- Grivas, TB ; Burwell, RG & Purdue, M (1992) Segmental patterns of rib-vertebra angles in chest radiographs of children: changes related to rib level, age, sex, side and significance for scoliosis. *Clinical Anatomy*, 5: 272-288
- Grivas, TB; Burwell, RG & Purdue, M (1992). The rib cage deformity in infantile idiopathic scoliosis—the funnel-shaped upper chest in relation to specific rotation as a prognostic factor. An evaluation of thoracic shape in progressive scoliosis and control children during growth. In: A. Alberti, B. Drerup and E. Hierholzer (editors) Sixth International Symposium on Surface Topography and Spinal Deformity (Stuttgart: Gustav Fischer), pp. 93-109
- Grivas, TB; Samelis P; Polyzois, BD; Giourelis, B & Polyzois, D (2002). School screening in the heavily industrialized area--Is there any role of industrial environmental factors in idiopathic scoliosis prevalence?. *Stud Health Technol Inform*; 91: 76-80.
- Grivas, TB;; Dangas, S; Polyzois, BD & Samelis, P (2002) The Double Rib Contour Sign (DRCS) in lateral spinal radiographs: aetiologic implications for scoliosis. *Stud Health Technol Inform*; 88: pp 38-43
- Grivas, TB; Vasiliadis, ES; Mihas, C, & Savvidou, O (2007). The effect of growth on the correlation between the spinal and rib cage deformity: implications on idiopathic scoliosis pathogenesis.. *Scoliosis*: 14; 2: 11.
- Grivas, TB; Vasiliadis, ES; Mihas, C ; , Triantafyllopoulos, G & Kaspiris, A (2008). Trunk asymmetry in juveniles. *Scoliosis*: 23; 3: 13.
- Grivas, TB; Vasiliadis, E; Savvidou, OD & Triantafyllopoulos, G(2008). What a school screening program could contribute in clinical research of idiopathic scoliosis aetiology. *Disabil Rehabil*; 30(10): 752-62
- Grivas, TB; Burwell, RG; Mihas, C; Vasiliadis, ES; Triantafyllopoulos, G & Kaspiris, A(2009) Relatively lower body mass index is associated with an excess of severe truncal asymmetry in healthy adolescents: Do white adipose tissue, leptin, hypothalamus and sympathetic nervous system influence truncal growth asymmetry?. *Scoliosis*: 30; 4:13
- Guth, V & Abbink, F (1980) Vergleichende electromyographische und kinesiologische Skoliosen. *Z Orthop* 118:165-172
- Guyton, AC (1976) Textbook of medical physiology, 5th edn. WB Saunders, Philadelphia, pp 640-708
- Hain, TC; Yoo, H; Rudisill, H & Tanaka-Cameron, A (2006) Vemp testing in bilateral vestibular loss. Poster at ANA annual meeting, Chicago Oct 9
- Hagglund, G; Karlberg, J & Willner, S (1992) Growth in girls with adolescent idiopathic scoliosis. *Spine* 17: 108-111

- Henssge, J (1962) Electromyographischen Befunde der Rückenmusculatur nach Poliomyelitis und bei idiopathischen Scoliosen. *Z Orthop* 96:324-334
- Herman, R & McEwen, D (1979) Idiopathic scoliosis: a visio-vestibular disorder of the central nervous system. In: Zorab PA (ed) *Scoliosis. Proceedings of the Sixth Symposium*. Academic Press, pp 61-69
- Herman, R; Stuyck, J & Maulucci, R (1982) Development and plasticity of visual and vestibular generated eye movements. *Exp Brain Res* 47:69-78
- Herman, R; Mixton, J; Fisher, A; Maulucci, R & Stuyck, J (1985) Idiopathic scoliosis and the central nervous system: a motor control problem. *Spine* 10:1-14
- Hoogmartens, MJ & Basmajian, JV (1976) Postural tone in the deep spinal muscles of idiopathic scoliosis patients and their siblings. *Electromyogr Clin Neurophysiol* 16:93-114
- Kamman, LLJ (2003) *Stability of the Spinw. An Application to Scoliosis Progression*. Thesis, University of Twente. ISBN 90-365-1857-1
- Kapetanios, G; Potoupnis, M; Dangilas, A; Markou, K & Pournaras, J (2002). Is the labyrinthine dysfunction a causative factor in idiopathic scoliosis? *Stud Health Technol Inform.*; 91:7-9.
- Knuttsen F (1961) Growth and differentiation of the postnatal vertebra. *Acta Radiol* 55, 401-408
- Lambert, FM; Malinvaud, D; Glaune's, J; Bergot, C; Straka, H & Vidal, PP (2009) Vestibular asymmetry as the cause of idiopathic scoliosis, A possible answer from Xenopus J *Neuroscience*, October 7, 29(40): 12477-12483
- Leong, JC; Low, WD; Mok, CK; Kung, LS & Yau, AC (1982) Linear growth in southern Chinese female patients with adolescent idiopathic scoliosis. *Spine* 7: 471-475
- Loncar-Dusek, M; Pecina, M & Preberg, Z (1991) A longitudinal study of growth velocity and development of secondary gender characteristics versus onset of idiopathic scoliosis. *Clin Orthop* 270:278-282
- Lonstein, JE & Carlson, JM (1984) The prediction of curve progression in untreated idiopathic scoliosis during growth. *J Bone Joint Surg Am* 66: 1061-1071
- Low, WD; Mok, CK; Leong, JC; Yau, AC & Lisowski, FP (1978) The development of southern Chinese girls with adolescent idiopathic scoliosis. *Spine* 3:152-156
- Low, WD; Chew, EC; Kung, HTC; Hisli, LCS & Leong, JCY (1983) Ultrastructures of nerve fibres and muscle spindles in adolescent idiopathic scoliosis. *Clin Orthop* 174: 217-221
- Matthews, PBC (1969) Muscle spindles and their motor control. *Physiol Rev* 44:219-288
- Matthews, PBC (1969) Evidence that the secondary as well as primary endings of the muscle spindles may be responsible for the tonic stretch reflex of the decerebrate cat. *J Physiol* 204: 365-393
- Mattson, G; Haderspeck-Grib, K; Schultz, AB & Nachemson, A (1983) Joint flexibility in structural normal girls and girls with idiopathic scoliosis. *J Orthop Res* 1:57-62
- Meyer, GH (1866) Die Mechanik der Skoliose. *Archiv für pathologische Anatomie und Physiologie und für klinische Medicin* 35:15-253
- Michelsson, JE (1965) The development of spinal deformity in experimental scoliosis. *Acta Orthop Scand Suppl* 81:1-91
- Millner, PA & Dickson, RA (1996) Idiopathic scoliosis. *Biomechanics and biology*. *Eur Spine J* 5:362-373

- Mixon, R & Steel, H (1982) Oculomotor control in children with idiopathic scoliosis. Presented at the Seventeenth Annual Scoliosis Research Society Meeting, Denver, Colorado
- Murray, DW & Bulstrode, CJ (1996) the development of adolescent idiopathic scoliosis. *Eur Spine J* 5:251-257
- Nasher, LM (1982) Adaptation of human movement to altered environments. *Trends Neurosci* 5:358-361
- Neugebauer, H (1976) Skoliose, Stoffwechsel und Wirbelsäulenwachstum. *Arch Orthop Unfallchir* 85; 87-99
- Nijenbanning, G (1998) Scoliosis redress. Design of a force controlled orthosis. Thesis, University of Twente, ISBN 90-36511925
- Nordwall, A & Willner, SA (1975) A study of skeletal age and height in girls with idiopathic scoliosis. *Clin Orthop* 110:6-10
- Normelli, A; Sevastik, J; Ljung, G; Aaro, S & Jonsson-Soderstrom, AM (1985) Anthropometric data relating to normal and scoliotic Scandinavian girls. *Spine* 10:123-126
- Pal, GP (1991) Mechanism of production of scoliosis: a hypothesis. *Spine*, 16: 288-292, 1991.
- Perdriolle, R; Becchetti, S; Vidal, J & Lopez, P (1993) Mechanical process and growth. Essential factors in the progression of scoliosis. *Spine* 18: 343-349
- Petersen, I; Sahlstrand, T & Sellden, U (1979) Electroencephalographic investigation of patients with adolescent idiopathic scoliosis. *Acta Orthop Scand* 50:283-293
- Pincott, JR (1980) Observations on the afferent nervous system in idiopathic scoliosis. In: Zorab PA, Siegler D (eds) *Scoliosis*. Academic Press, London New York, 45-49
- Pincott, JR & Taffs, LF (1982) Experimental scoliosis in primates: a neurological cause. *J. Bone Joint Surg Br* 64:503-507
- Plaats, A van de (1997) Numerical analysis of idiopathic scoliosis using the finite element method. Internal report: BW-91. Technical University of Twente
- Plaats, A van de; Veldhuizen, AG, & Verkerke, GJ (2007) Numerical simulation of asymmetrically altered growth as initiation mechanism of scoliosis. *Ann Biomed Eng*: 35(7):1206-1215..
- Raso, VJ (1998) Review of biomechanics in the aetiology of idiopathic scoliosis Presented at the Tenth International Philip Zorab Symposium, Oxford
- Redford, JB; Butterworth, TR & Clements, EL (1969) Use of electromyography as a prognostic aid in the management of idiopathic scoliosis. *Arch Phys Med Rehabil* 58:433-438
- Riddle, HFV & Roaf, R (1955) muscle imbalance in the causation of scoliosis. *Lancet*: 1245-1247
- Roaf, R (1960) Vertebral growth and its mechanical control. *J Bone Joint Surg Br* 42:40-59
- Roaf, R (1966) The basic anatomy of scoliosis. *J Bone Joint Surg Br* 48:786-792
- Sahlstrand, T; Petruson, B & Ortengren, R (1979) Vestibulospinal reflex activity in patients with adolescent idiopathic scoliosis. *Acta Orthop Scand* 50:275-281
- Sahlstrand, T & Petruson, B (1979) A study of labyrinthine function in patients with adolescent idiopathic scoliosis. *Acta Orthop Scand* 50:759-769
- Sahlstrand, T & Petruson, B (1979) Postural effects on nystagmus response during caloric labyrinthine stimulation in patients with adolescent idiopathic scoliosis. *Acta Orthop Scand* 50:771-775

- Sahlstrand, T & Lindstrom, J (1980) Equilibrium factors as predictor of the prognosis in adolescent idiopathic scoliosis. *Clin Orthop* 152:232-236
- Sahlstrand, T (1980) An analysis of lateral predominance in adolescent idiopathic scoliosis with special reference to convexity of the curve. *Spine* 5:512-517
- Saltin, B; Henriksson, J; Nijgaard, E & Andersen, P(1977) Fibre-types and metabolic potentials of skeletal muscles in sedentary man and endurance runners. 1. Metabolism in prolonged exercise. *Ann N Y Acad Sci* 301:3-29
- Sanders, JO; Browne, RH & McConnell, SJ(2007) Maturity assessment and curve progression in girls with idiopathic scoliosis. *J Bone Joint Surg. Am*; 89:64-73.
- Sevastik, JA (2000). The thoracospinal concept of the etiopathogenesis of idiopathic scoliosis. *Spine: State of the Art Reviews*, 14: 391-400
- Sevastik, JA; Burwell, RG & Dangerfield, PH (2003) A new concept for the etiopathogenesis of the thoracospinal deformity of idiopathic scoliosis: summary of an electronic focus group debate of the IBSE. *European Spine Journal*, 12: 440-450
- Sharp, JA; Lo, AW & Rabinovitch, HE (1979) Control of saccadic and smooth pursuit systems after cerebral hemidecortication. *Brain* 102:387- 403
- Shohat, M; Shohat, T & Nitzan, M(1988) Growth and ethnicity in scoliosis. *Acta Orthop Scand* 59:310-313
- Skogland, LB & Miller, JAA (1981) The length and proportions of the thoracolumbar spine in children with idiopathic scoliosis. *Acta Orthop Scand* 52:177-185
- Smith, RM & Dickson, RA (1987) Experimental structural scoliosis. *J Bone Joint Surg Br* 69:576-581
- Snijder, LH; Brotchie, P & Andersen, RA (1993) World-centred encoding of location in posterior parietal cortex of monkey. *Soc Neurosci Abstr* 19:770
- Somerville, EW (1952) Rotational lordosis. The development of the single curve. *J Bone Joint Surg Br* 34:421- 427
- Spencer, GSG & Eccles, MJ (1976) Spinal muscle in scoliosis. 2. The proportion and size of Type 1 and Type 2 skeletal muscles fibres measured using computer- controlled microscope. *J Neurol Sci* 30:143-156
- Sisson, HA (1971) The biochemistry and physiology of bone. *Development and Growth* (Ed. GH Bourne) vol 111, page 116. Academic Press, New York
- Stokes, IAF; Spense, H; Aronsson, DD & Kilmer, N (1996) Mechanical modulation of vertebral body growth. Implication for scoliosis progression. *Spine* 21:1162-1167
- Taffs, LF; Magrath, DI & Lytton, NA (1979) Monkey scoliosis. *Lancet* 1:1078-1079
- Tanner, JM (1962) *Growth at Adolescence*. 2nd Edition ed. Oxford: Blackwell Scientific Publ
- Tanner, JM (1978) *Foetus into Man. Physical Growth from Conception to Maturity*. OBP London
- Tanner, JM & Davies, PS (1985) Clinical longitudinal standards for height and height velocity for North American children. *J. Pediatr*; 107: 317-29.
- Tanner, JM; Whitehouse, RH & Takaishi, M (1965) Standards from birth to maturity for height, weight, height velocity, and weight velocity: British children, *Arch. Dis. Child* 41: 454-71.
- Taffs, LF; Magrath, DI & Lytton, NA (1979) Monkey scoliosis. *Lancet* 1:1078-1079
- Taylor, JR (1983) Scoliosis and growth: patterns of asymmetry in normal vertebral growth. *Acta Orthop Scand* 54:596-602
- Tezuka, A (1971) Development of scoliosis in cases with congenital organ abnormalities of the brainstem. *Tokushima J Exp Med* 18:49-62

- Veldhuizen, AG (1985) Idiopathic scoliosis. A biomechanical and functional- anatomical study. Thesis, University of Groningen, van Denderen
- Veldhuizen, AG; Baas, P & Webb, PJ (1986) Observations on the growth of the adolescent spine. *J Bone Joint Surg Br* 68:724-728
- Veldhuizen, AG & Scholten, PJM (1990) Flexibility in structural normal young females and in young females with idiopathic scoliosis. *Clin Biomech* 5:117-119
- Webb, PJ (1973) The effect of innervation, denervation and muscle type on the reunion of skeletal muscle. *Br J Surg* 60: 180-182
- Webb, PJ (1981) Electromyographic changes in scoliosis. Presented at the British-Scandinavian Joint Scoliosis Meeting of the British Scoliosis Society, Jersey
- Wever, DJ; Veldhuizen,AG; Klein, JP; Webb, PJ; Nijenbanning, G; Cool JC& v Horn, JR (1999) A biomechanical analysis of the vertebral and rib deformities in structural scoliosis. *Eur Spine J* 8:252-260
- Wever, DJ; Tonseth, KA; Veldhuizen, AG; Nijenbanning, G; Cool, JC & v Horn, J (2000) Curve progression and spinal growth in brace treated idiopathic scoliosis. *Clin Orthop Res* 377, 169-179
- Whitecloud, TS; Cook, SD; Burke, SW; Leinhardt, T & Barrack, RL (1984) Upper extremity proprioceptive deficit in idiopathic scoliosis. Presented at the Nineteenth Annual Scoliosis Research Society Meeting, Orlando, Florida
- Wiener-Vacher, SR & Mazda, K (1998) Asymmetric otolith vestibulo-ocular responses in children with idiopathic scoliosis. *J Pediatr* 132: 1028-32
- Willner, SA (1974) Study of growth in girls with adolescent structural scoliosis. *Clin Orthop* 101: 29-135
- Willner, SA (1975) Study of height, weight and menarche in girls with idiopathic structural scoliosis. *Acta Orthop Scand* 46:71-83
- Willner, SA (1975) The proportion of legs to trunk in girls with idiopathic scoliosis. *Acta Orthop Scand* 46:84- 89
- Wong, VC; Yak, ACMC; Low, WD; Chin, NK & Lisowsky, FK (1980) Ultrastructural changes of the back muscles in idiopathic scoliosis. *Spine* 2: 251-260
- Yarom, R & Robin, GC (1979) Studies on spinal and peripheral muscles from patients with scoliosis. *Spine* 4:12-21
- Yasui, S & Young, LR (1976) Eye movements during and after image tracking under sinusoidal and random vestibular stimulation. In: Monty RA, Senders JW (eds) *Eye movements and psychological process*. Erlbaum, New Jersey, 33-37
- Yekutieli, M; Robin, GC & Grimby, G (1981) Proprioceptive function in children with adolescent idiopathic scoliosis. *Spine* 6:560-566
- Ylikowski, M (1993) Spinal growth and progression of adolescent idiopathic scoliosis. *Eur Spine J* 1:236- 239
- Young, LR (1977) Pursuit eye movement - what is being pursued? In: Baker R, Berthoz A (eds) *Control of gaze by brainstem neurons*. Elsevier/ North Holland, Amsterdam, 29-36
- Yrjonen, T & Ylikoski, M (2006) Effect of growth velocity on the progression of adolescent idiopathic scoliosis in boys. *J.Pediatr.Orthop.B*; 15:311-5.
- Zetterberg, C; Bjork, R; Ortengren, R & Andersson, GBJ (1984) Electromyography of the paravertebral muscles in idiopathic scoliosis. *Acta Orthop Scand* 55:304-309

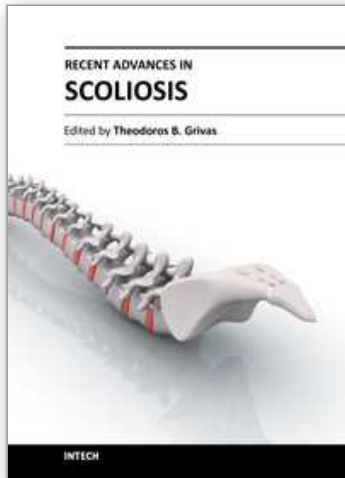

Recent Advances in Scoliosis

Edited by Dr Theodoros Grivas

ISBN 978-953-51-0595-4

Hard cover, 344 pages

Publisher InTech

Published online 09, May, 2012

Published in print edition May, 2012

This book contains information on recent advances in aetiology and pathogenesis of idiopathic scoliosis, for the assessment of this condition before treatment and during the follow-up, making a note of emerging technology and analytical techniques like virtual anatomy by 3-D MRI/CT, quantitative MRI and Moire Topography. Some new trends in conservative treatment and the long term outcome and complications of surgical treatment are described. Issues like health related quality of life, psychological aspects of scoliosis treatment and the very important "patient's perspective" are also discussed. Finally two chapters tapping the untreated early onset scoliosis and the congenital kyphoscoliosis due to hemivertebra are included. It must be emphasized that knowledgeable authors with their contributions share their experience and enthusiasm with peers interested in scoliosis.

How to reference

In order to correctly reference this scholarly work, feel free to copy and paste the following:

F.H. Wapstra and A.G. Veldhuizen (2012). Hypothesis on the Pathogenesis of Idiopathic Scoliosis, Recent Advances in Scoliosis, Dr Theodoros Grivas (Ed.), ISBN: 978-953-51-0595-4, InTech, Available from: <http://www.intechopen.com/books/recent-advances-in-scoliosis/hypothesis-on-the-pathogenesis-of-idiopathic-scoliosis>

INTECH
open science | open minds

InTech Europe

University Campus STeP Ri
Slavka Krautzeka 83/A
51000 Rijeka, Croatia
Phone: +385 (51) 770 447
Fax: +385 (51) 686 166
www.intechopen.com

InTech China

Unit 405, Office Block, Hotel Equatorial Shanghai
No.65, Yan An Road (West), Shanghai, 200040, China
中国上海市延安西路65号上海国际贵都大饭店办公楼405单元
Phone: +86-21-62489820
Fax: +86-21-62489821

© 2012 The Author(s). Licensee IntechOpen. This is an open access article distributed under the terms of the [Creative Commons Attribution 3.0 License](#), which permits unrestricted use, distribution, and reproduction in any medium, provided the original work is properly cited.

IntechOpen

IntechOpen