

# We are IntechOpen, the world's leading publisher of Open Access books Built by scientists, for scientists

4,400

Open access books available

117,000

International authors and editors

130M

Downloads

Our authors are among the

154

Countries delivered to

TOP 1%

most cited scientists

12.2%

Contributors from top 500 universities



WEB OF SCIENCE™

Selection of our books indexed in the Book Citation Index  
in Web of Science™ Core Collection (BKCI)

Interested in publishing with us?  
Contact [book.department@intechopen.com](mailto:book.department@intechopen.com)

Numbers displayed above are based on latest data collected.  
For more information visit [www.intechopen.com](http://www.intechopen.com)



## A Fast Handover Scheme for WiBro and cdma2000 Networks

Choongyong Shin, Seokhoon Kim and Jinsung Cho  
*Kyung Hee University  
South Korea*

### 1. Introduction

The continuous development of wireless communication technologies yields diverse wireless networks that are widely deployed and successfully serviced according to their communication capabilities. Representative examples are cellular networks (e.g., cdma2000 and UMTS) capable of wide-area coverage and WLAN (Wireless LAN) efficiently used in public hot spots. WLAN and cellular network are complementary technologies. WLAN has several advantages over cellular networks, including higher data rate and lower operating and equipment costs. However, their coverage is typically limited to corporate buildings, residence, and certain public hot spots. On the other hand, cellular networks provide wide-area coverage but at lower speeds and much higher cost. It is indispensably required to integrate WLAN and cellular networks to serve users who need both high-speed wireless access as well as wide-area connectivity (Salkintzis, 2004).

Integrating heterogeneous networks reveals a lot of difficulties due to their different system specifications, standardization, and service scopes. For this reason, most of research work (3GPP, 2003; Ahmavaara et al., 2003; Buddhikot et al., 2003; Luo et al., 2003) are focused on interworking mechanism between network elements rather than integrating whole network architectures. Recently, with the intention of overcoming the limitation of existing wireless networks, new wireless communication service, WiBro is being deployed in Korea. WiBro is based on IEEE 802.16e (IEEE, 2001; Koffman & Roman, 2002) and is similar with Mobile WiMAX (Forum, n.d.). It is expected to provide enough mobility (60km/h) and higher data rate (50Mbps). So the study of the integration between WiBro and cdma2000 will give better effects than the existing works of the integration between WLAN and cdma2000.

In order to provide seamless services across heterogeneous wireless networks, efficient handoff procedure as well as flexible integrated network architecture is essentially required. As for handoff procedure, it is possible to use Mobile IP (Perkins, 2002) which is generally used in for homogeneous network or its extended version, so called low-latency handoff which tends to reduce packet loss and delay during the handoff (Maki, 2004). However, since these handoff procedures exploit L3 (layer 3) signaling messages, they have a problem that packet loss and delay can occur while processing L3 messages. In this paper, we propose an efficient L2 (layer 2) handoff scheme between cdma2000 and WiBro networks. The proposed L2 handoff scheme takes advantages over the existing L3 handoff scheme because it exploits L2 messages instead of L3 messages. We show the efficiency of our proposed L2 handoff through extensive computer simulations.

The paper is organized as follows: Section 2 summarizes existing techniques for handoff scheme as related work. Section 3 presents the proposed L2 handoff scheme and we describe the performance characteristics of the proposed scheme through OPNET simulation in Section 4. Section 5 concludes the paper.

## 2. Handoff in heterogeneous wireless networks

Since the integration of widely deployed 3G cdma2000 and WLAN can give a lot of benefits to both end users and service providers, there has been a lot of researches about interworking mechanism between cdma2000 and WLAN (3GPP, 2003; Ahmavaara et al., 2003; Buddhikot et al., 2003; Luo et al., 2003; Salkintzis, 2004). The WLAN and 3G cdma2000 integration architecture is characterized by the amount of interdependence it introduces between the two component networks. Two candidate integration architectures, tightly-coupled and loosely-coupled interworking are described in Fig. 1.

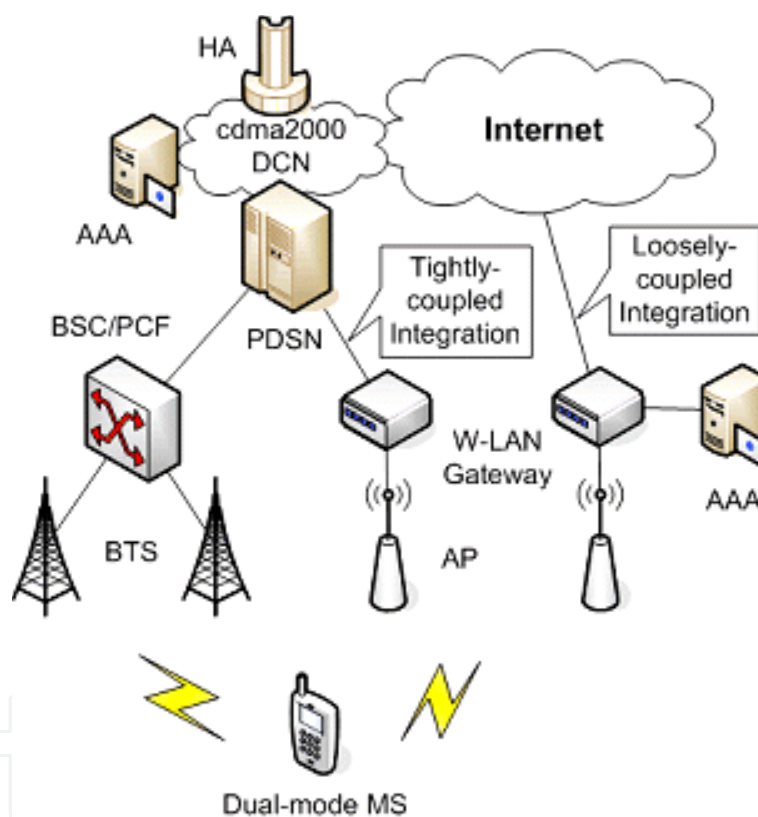

Fig. 1. Interworking architecture of heterogeneous wireless networks

In the tightly-coupled interworking approach, WLAN networks appear to 3G core network as another 3G RAN (Radio Access Network). The WLAN gateway hides the details of the WLAN network to the 3G core network, and implements all the 3G protocols. Even though this approach can share the same authentication, signaling, and billing infrastructures, independent from physical layer interface, it has a disadvantage that the capacity and configuration of each network element is carefully reengineered and can result in high cost. On the contrary, the loosely-coupled interworking approach has several advantages such that 3G networks and WLAN can be independently deployed without extensive capital investments and its implementation is relatively easy. Therefore, it has emerged as a preferred

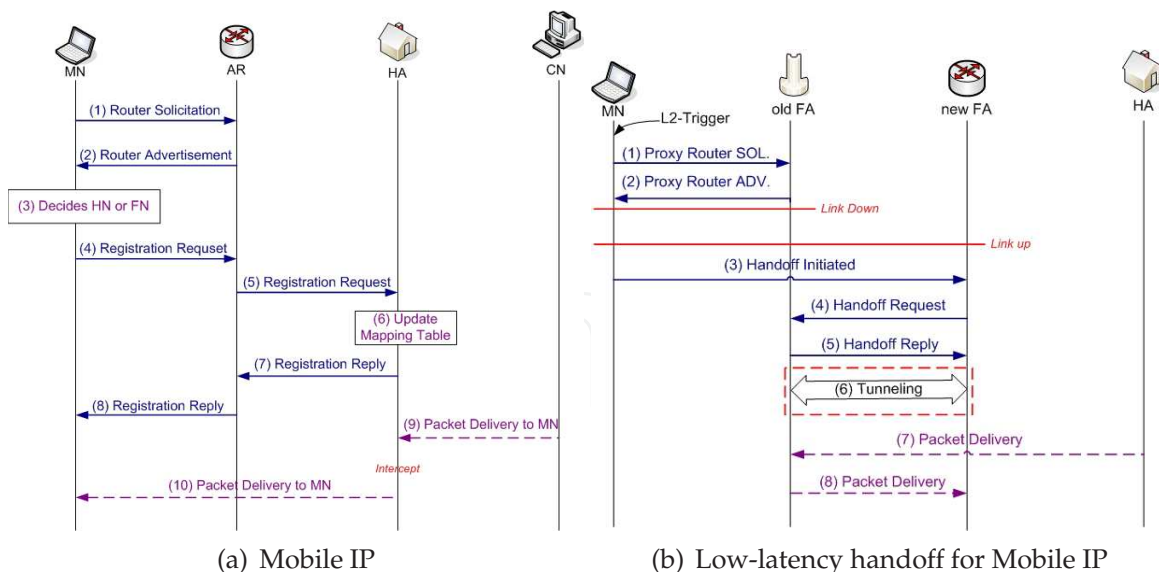

Fig. 2. L3 handoff procedure

architecture for the integration of WLAN and 3G networks. As previously mentioned, the L3 handoff procedure is commonly used to provide mobility services in the loosely coupled interworking architecture. Mobile IP is the representative technology of L3 handoff to provide mobility services within homogeneous 3G cdma2000 or between 3G cdma2000 and WLAN. When mobile station moves into new wireless network, Mobile IP performs registration procedure and handoff are completed after registration procedure as shown in Fig. 2(a). The low-latency handoff for Mobile IP (Maki, 2004) is proposed to reduce packet loss occurred in the registration procedure. It reduces packet loss by providing tunneling and buffering between the previous and new networks as depicted in Fig. 2(b). Since the current cdma2000 networks employ Mobile IPv4, we deal with Mobile IPv4 and its extended version in this paper. So the low latency handoff for Mobile IPv4 in Fig. 2(b) will be used in performance evaluation of Section 4. In IPv6 environment, however, fast handoff for Mobile IPv6 (Koodli, 2005) can be considered similarly.

### 3. Proposed L2 handoff scheme

#### 3.1 Overview of L2 handoff

For wireless communication, mobile terminal performs step-by-step layered procedures. First, when it is initially booted or located in new wireless network area, it scans L1 signal. As soon as it detects L1 signal, it performs L2 connection procedure. After successful L2 connection, mobile terminal can communicate or send/receive packets. The L3 handoff described in Section 2 initiates handoff after L2 connection. Our proposed L2 handoff procedure exploits L2 signaling messages transmitted during L2 connection setup. By acquiring packet flow path between network elements (e.g. PDSN and ACR in Fig. 3) while processing L2 messages, our method reduces packet loss occurred in handoff.

The proposed L2 handoff procedure considers the interworking network architecture as shown in Fig. 3. The cdma2000 and WiBro networks are loosely-coupled integrated through interworking between PDSN of cdma2000 and ACR of Wibro. So in exception of interworking of PDSN and ACR, each network is working and servicing independently. Our L2 handoff

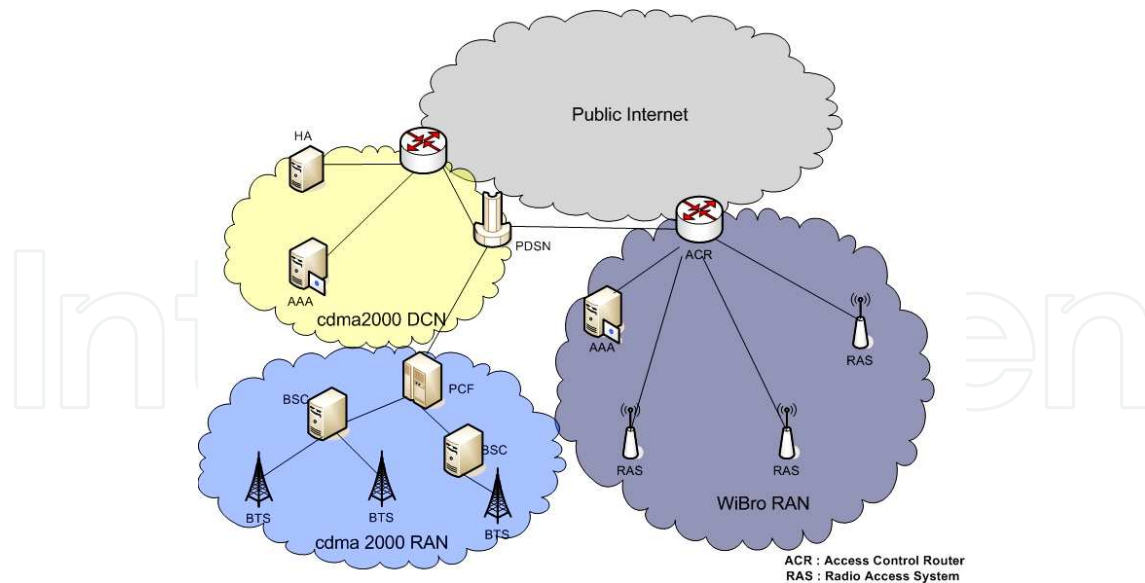

Fig. 3. Interworking Architecture between cdma2000 and WiBro networks

procedure exploits L2 signaling messages commonly existing in cdma2000 and WiBro. It does not require additional signaling messages so that our scheme can be implemented with ease.

### 3.2 L2 handoff procedure

In this section, we describe the proposed L2 handoff procedure. We consider two handoff scenarios. The first case is that the mobile station is moving from cdma2000 cellular network into WiBro. The second one is the reverse case. We do not consider the cases that handoff is occurring within its own wireless network, i.e., cdma2000 or WiBro. We also do not consider the initial call setup procedures for its own wireless network, since it is followed as described in standardization of each wireless network.

Fig. 4 describes the proposed L2 handoff procedure. When the mobile station moves into a new network area, it processes L2 connection procedure. At this time, handoff information is transmitted to the network through the Origination message of cdma2000 or L2 REG-REQ message of WiBro as shown in (1) of Fig. 4(a) and (1) of Fig. 4(b), respectively. More specifically, the Origination message includes PANID (Previous Access Network ID). If the cdma2000 system receives the Origination message which contains PANID=ANID of WiBro, the cdma2000 system regards it as a vertical handoff from WiBro network. Similarly, the REG-REQ message of WiBro can contain PANID=ANID of cdma2000 which means a vertical handoff from cdma2000 network. With such handoff information, the source PDSN or ACR detects the occurrence of handoff and extracts the target ACR or PDSN address for the handoff. Based on this address information, PDSN and ACR requests each other and generates tunnel for the handoff traffic. After the tunnel is setup, the corresponding PDSN or ACR is buffering packets destined to the mobile station while the requested L2 connection is being made.

### 3.3 Standardization issues

Consider a mobile station moves from WiBro to cdma2000 networks as depicted in Fig. 4(a). When MS requests a communication channel to BSS, a bearer path MS-BSSPCF-PDSN-ACR



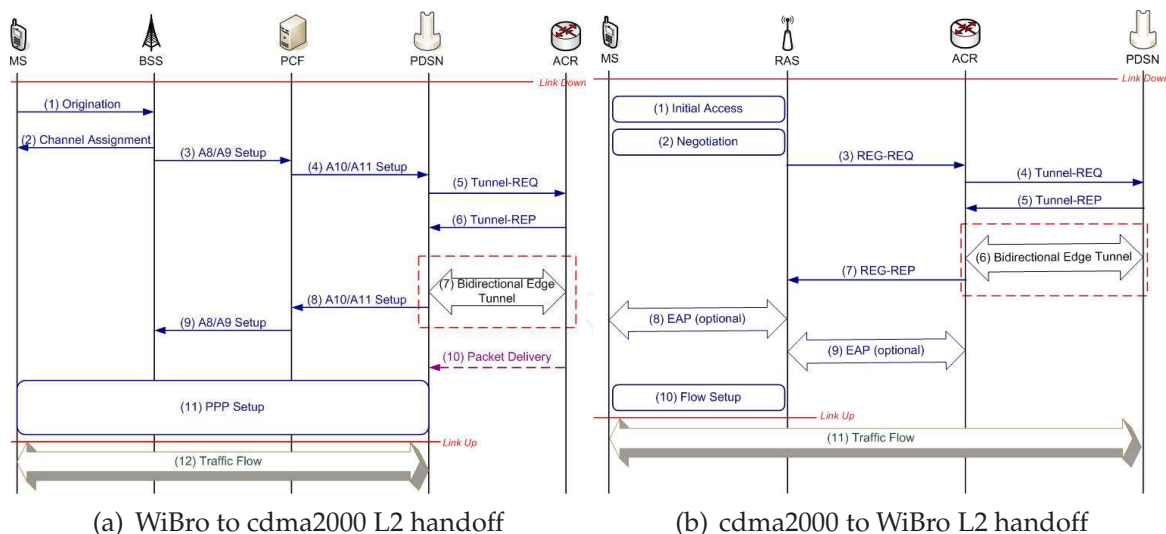

Fig. 4. L2 handoff procedure

should be setup, where ACR is the service anchor point in WiBro network. The origination message in (1) of Fig. 4(a) contains PANID field so that PDSN can connect to the appropriate anchor ACR using the field (3GPP2, 2002). To do this, a mapping function from the base station ID in WiBro network to ANID in cdma2000 network is required. A possible solution may be as follows: construct 48-bits base station ID in WiBro with SID (16 bits), NID (16 bits), PZID (8 bits), and base station number in a packet zone (8 bits), where SID, NID, PZID comprise ANID in cdma2000 network.

Next, let us consider a mobile station moves from cdma2000 network to WiBro in Fig. 4(b). Similarly to the aforementioned case, when MS requests a communication channel to RAS, a bearer path MS-RAS-ACR-PDSN should be setup, where PDSN is the service anchor point in cdma2000 network. In order for ACR to connect to the right PDSN, PANID field should be delivered to ACR via RAS. It can be implemented by adding PANID field in MAC management messages of WiBro standard specifications.

With this slight modification of standard specifications, the proposed L2 handoff scheme can be implemented as explained in this section. In addition, the fast handoff mechanism between PDSN and ACR will provide seamless services on vertical handoff. In the next section, we validate its performance.

#### 4. Experimental evaluation

##### 4.1 Simulation model

The OPNET simulation, as shown in Fig. 5, has been conducted to examine the performance of the proposed scheme. We assume that there are 135 mobile stations used in the simulation and the traffic parameters are set as in Table 1.

$$f_{init}(v) = \begin{cases} k \frac{1}{\sqrt{2\pi}\sigma} e^{-\frac{(v-m)^2}{2\sigma^2}} & , v \geq 0 \\ 0, & v < 0 \end{cases} \quad (1)$$

	Conversational	Streaming	Interactive	Background
Max. Bit Rate (Mb/s)	2.4 (EV-DO), < 2 (WiBro)	2.4 (EV-DO), < 2 (WiBro)	2.4 (EV-DO), < 2 (WiBro)	2.4 (EV-DO), < 2 (WiBro)
Max Packet Size (byte)	$\leq 1500$ or 1502	$\leq 1500$ or 1502	$\leq 1500$ or 1502	$\leq 1500$ or 1502
Packet Error Ratio	$10^{-2}, 7^*$ , $10^{-3}, 10^{-3}$ , $10^{-4}, 10^{-5}$	$10^{-1}, 10^{-2}$ , $7^*$ , $10^{-3}, 10^{-3}$ , $10^{-4}, 10^{-5}$	$10^{-3}, 10^{-4}$ , $10^{-6}$	$10^{-3}, 10^{-4}$ , $10^{-6}$

Table 1. Simulation parameters

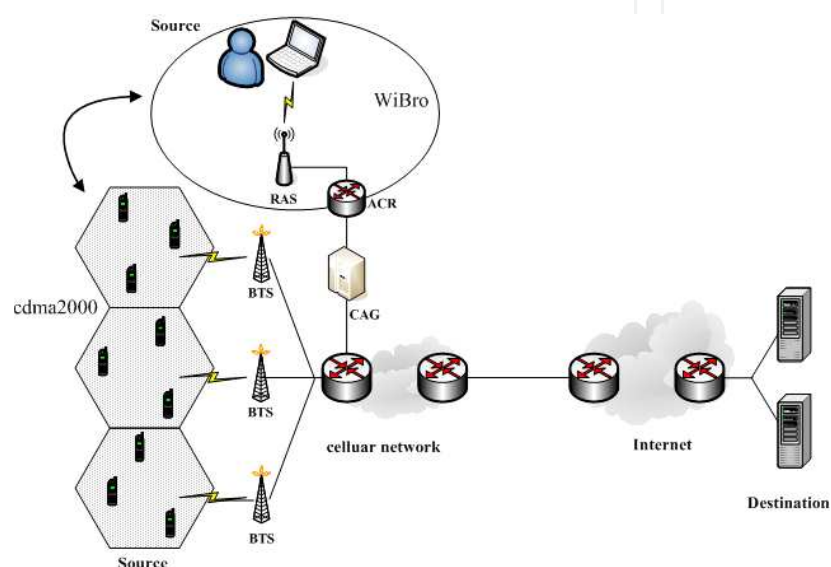

Fig. 5. Simulation model for performance evaluation

Fig. 7 shows only a small part of the entire model for simplicity although there are a lot of cdma2000 and WiBro cells. WiBro network cells and cdma2000 network cells are attached one by another in the simulation. Picocells and microcells are only used to generate frequent handoffs of mobile stations. Since the Markov mobility model used in the simulation, as shown in Fig. 8, is designed for mobile stations at low-speed (20 60km/h), and the following probability density function is used, where  $m$  represents the average speed of a mobile station in a cell (Janevski, 2003).

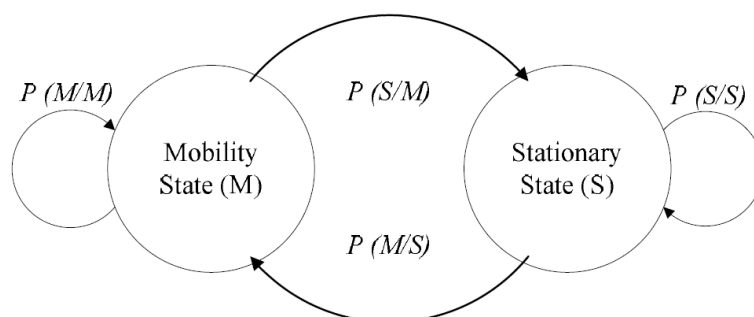

Fig. 6. Mobility model for mobile stations

#### 4.2 Simulation results

Both L3 and L2 handoff schemes are simulated to prove the superiority of the proposed L2 handoff over L3 handoff on most popular services in mobile environment, such as streaming, web browsing, and Email services. These services are categorized into streaming, interactive, and background traffic class, respectively. In addition, conversational class is also added for video conferencing environment. As mentioned earlier, the low latency handoff for Mobile IPv4 in Fig. 3 has been implemented for the L3 handoff scheme.

Fig. 7 - 10 show that the proposed L2 handoff scheme outperforms the L3 handoff on all kinds of service classes. In fact, performances resulted in each scheme should be the same except when handoffs occur. Therefore, performance differences shown in Fig. 9 - 12 are due to handoff processes. Figures also show that handoff occurrence is very frequent at interval times of 6 to 23, 32 to 35, and 55 to 57.

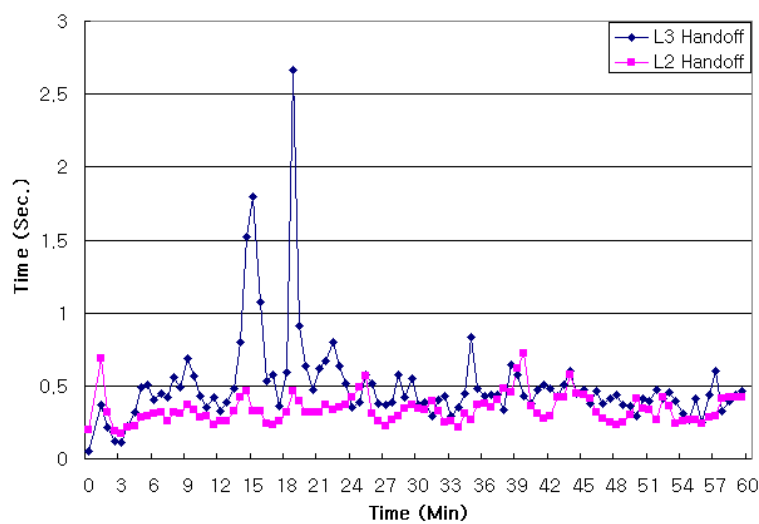

Fig. 7. Packet delay on conversational traffic class

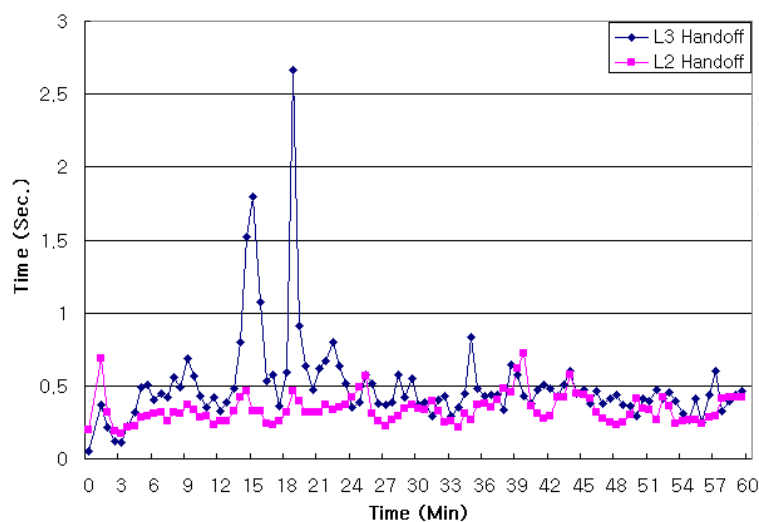

Fig. 8. Packet delay on streaming traffic class



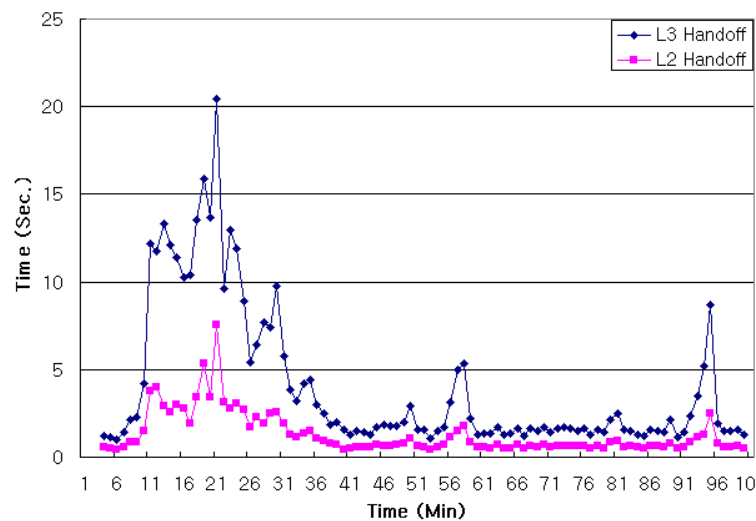

Fig. 9. Packet delay on interactive traffic class

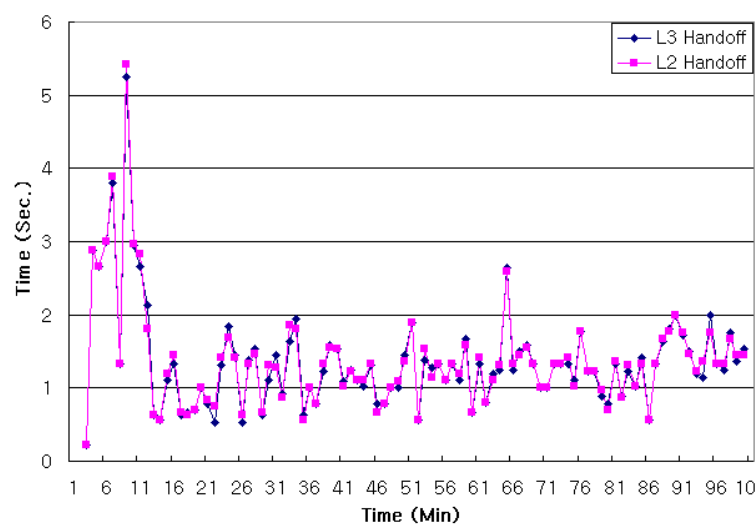

Fig. 10. Packet delay on background traffic class

Fig. 7 and Fig. 8 are the simulation results of conversational and streaming traffic classes, respectively. The graph of the L2 handoff scheme is more stable with small deviation than the L3 handoff because the L2 handoff reduces packet losses and delays.

Fig. 9 shows the case of interactive traffic class using HTTP, where differences in packet delays between L3 and L2 handoff are larger than those of Fig. 7 and Fig. 8 of the burst property of web traffic. We can find from Fig. 10 that background traffic class like Email shows almost no difference in delay performance because background traffic has the lowest priority.

In addition, we performed simulations with different moving speed of mobile stations. Fig. 11 - 14 show the average delay times of each traffic class of MS at different speed. The graph shows the superiority of the L2 handoff scheme over the L3 handoff scheme on all kinds of traffic classes and moving speeds. We can also find that the faster a mobile station moves,

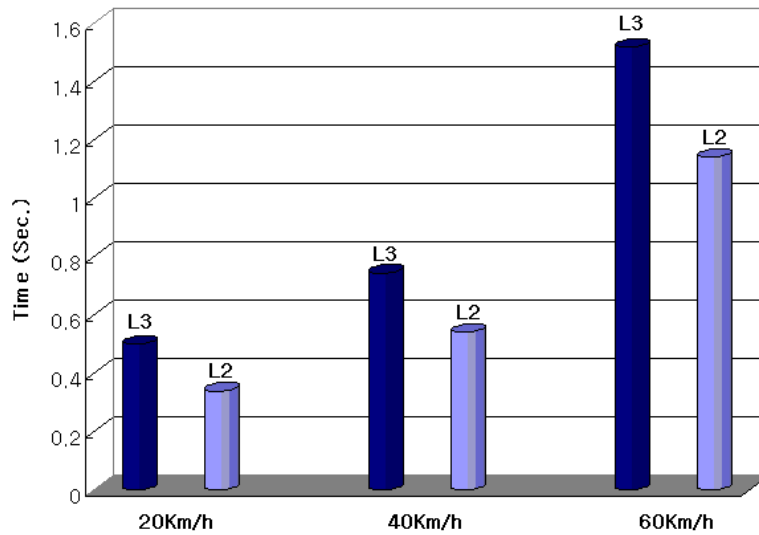

Fig. 11. Average delay according to MS's speed (conversational traffic class)

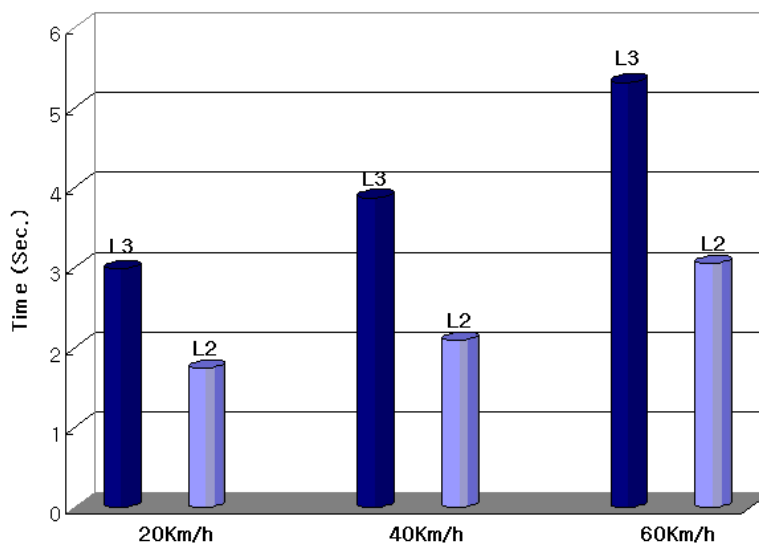

Fig. 12. Average delay according to MS's speed (streaming traffic class)

the larger differences in delay performance arise, because the fast moving causes frequent handoffs. We summarize the average packet delay in Table 2.

Finally, Fig. 15 describes the packet loss ratio in both schemes. Since the L3 handoff scheme employs mobile IP techniques, there may be relatively large number of packet loss.

In summary, the OPNET simulation results in this section indicate that the proposed L2 handoff scheme is an efficient and practical solution because it can be implemented with minimal modification of existing cdma2000 and WiBro networks while providing the reduced packet delay and loss.

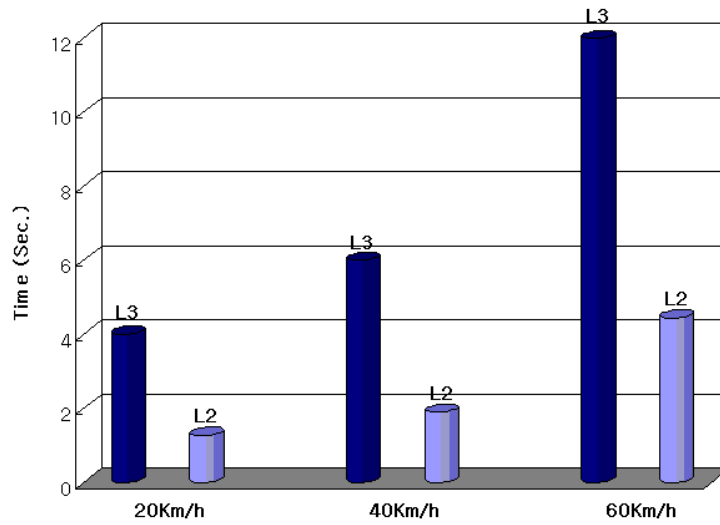

Fig. 13. Average delay according to MS's speed (interactive traffic class)

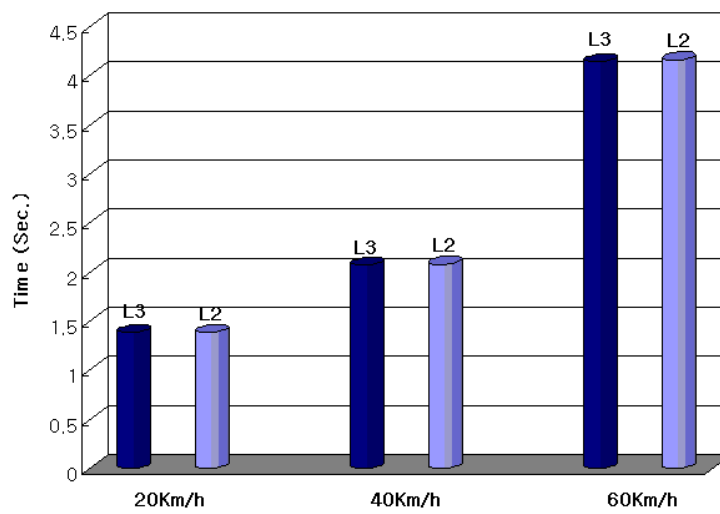

Fig. 14. Average delay according to MS's speed (background traffic class)

Traffic class	Handoff	20Km/h	40Km/h	60Km/h
Conversational	L3	0.495	0.743	1.485
	L2	0.335	0.537	1.117
Streaming	L3	2.953	3.839	5.316
	L2	1.726	2.071	3.020
Interactive	L3	5.829	8.743	17.487
	L2	2.459	3.689	8.608
Background	L3	3.358	4.365	6.549
	L2	3.371	4.382	6.574

Table 2. Summary of average delay according to MS's speed

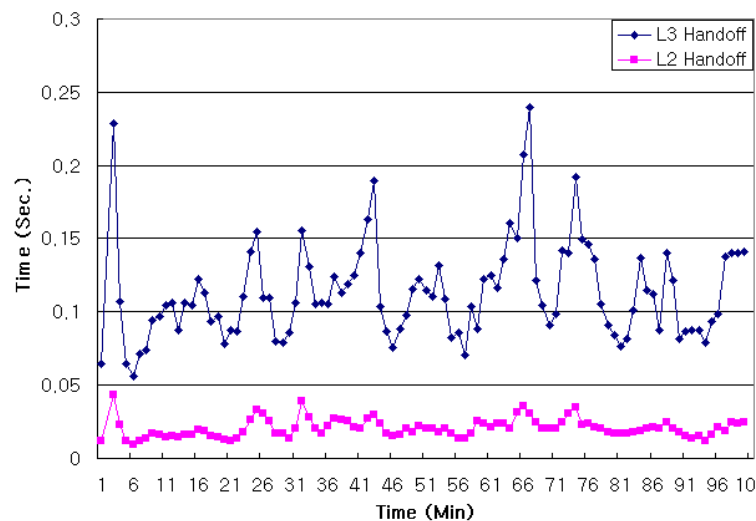

Fig. 15. Packet loss ratio

## 5. Conclusion

In this paper, we proposed a low-latency L2 handoff procedure between cdma2000 and WiBro which creates a promising next generation wireless network. Even though several efforts are actively in progress to improve mobility services based on Mobile IP, mobility services between different wireless networks, e.g., WiBro and cdma2000 still need more attention. From this viewpoint, we devise an L2 handoff scheme which can provide better performance compared with the L3 handoff. We also define required functionalities of each network element, ACR of WiBro, PDSN of cdma2000, and mobile station.

The proposed L2 handoff procedure does not require additional signaling messages to reduce packet loss which can occur in signaling L3 messages. However, in order to apply our scheme, the necessary functional change of network elements is inevitable. For completion, the detailed protocols above L3, e.g., session control remains to be further studied.

## 6. References

- 3GPP (2003). 3gpp tr 22.934, *Feasibility study on 3GPP system to Wireless Local Area Network(WLAN) Interworking (Release 6)*.
- 3GPP2 (2002). 3gpp2 a.s0011-a, *Interoperability Specification (IOS) for cdma2000 Access Network Interfaces : Part 1 Overview*.
- Ahmavaara, K., Haverinen, H. & Pichna, R. (2003). *Ieee communications magazine, Interworking Architecture between 3GPP and WLAN Systems* Vol. 41(No. 11): 74–81.
- Buddhikot, M., Chandranmenon, G., Han, S., Lee, Y., Miller, S. & Salgarelli, L. (2003). *Ieee communications magazine, Design and Implementation of a WLAN/cdma2000 Interworking Architecture* Vol. 41(No. 11): 90–100.
- Forum, W. (n.d.).  
URL: <http://www.wimaxforum.org>
- IEEE (2001). *Ieee std. 802.16, IEEE Standard for Local and Metropolitan Area Network Part 16 : Air Interface for Fixed Broadband Wireless Access System*.
- Janevski, T. (2003). *Artech house, Traffic analysis and design of wireless IP networks* pp. 186–190.

- Koffman, I. & Roman, V. (2002). *Ieee communications magazine, Broadband Wireless Access Solutions based on OFDM access in IEEE 802.16* Vol. 40: 96–103.
- Koodli, R. (2005). *Ietfrfc 4068, Fast Handovers for Mobile IPv6* .
- Luo, H., Jiang, Z., Kim, B. & Henry, P. (2003). *Ieee internet computing magazine, Integrating Wireless LAN and Cellular Data for the Enterprise* Vol. 7(No. 2): 25–33.
- Maki, K. E. (2004). *Ietf internet draft, Low Latency Handoffs in Mobile IPv4* .
- Perkins, C. (2002). *Rfc3344, IP Mobility Support for Ipv4* .
- Salkintzis, A. K. (2004). *Ieee wireless communications magazine, Interworking Techniques and Architectures for WLAN/3G Integration Toward 4G Mobile Data Networks* Vol. 11(No. 3): 50–61.

IntechOpen



## **Mobile Networks**

Edited by Dr. Jesús Ortiz

ISBN 978-953-51-0593-0

Hard cover, 192 pages

**Publisher** InTech

**Published online** 09, May, 2012

**Published in print edition** May, 2012

The growth in the use of mobile networks has come mainly with the third generation systems and voice traffic. With the current third generation and the arrival of the 4G, the number of mobile users in the world will exceed the number of landlines users. Audio and video streaming have had a significant increase, parallel to the requirements of bandwidth and quality of service demanded by those applications. Mobile networks require that the applications and protocols that have worked successfully in fixed networks can be used with the same level of quality in mobile scenarios. Until the third generation of mobile networks, the need to ensure reliable handovers was still an important issue. On the eve of a new generation of access networks (4G) and increased connectivity between networks of different characteristics commonly called hybrid (satellite, ad-hoc, sensors, wired, WIMAX, LAN, etc.), it is necessary to transfer mechanisms of mobility to future generations of networks. In order to achieve this, it is essential to carry out a comprehensive evaluation of the performance of current protocols and the diverse topologies to suit the new mobility conditions.

### **How to reference**

In order to correctly reference this scholarly work, feel free to copy and paste the following:

Choongyong Shin, Seokhoon Kim and Jinsung Cho (2012). A Fast Handover Scheme for WiBro and cdma2000 Networks, Mobile Networks, Dr. Jesús Ortiz (Ed.), ISBN: 978-953-51-0593-0, InTech, Available from: <http://www.intechopen.com/books/mobile-networks/a-fast-handover-scheme-for-wibro-and-cdma2000-networks>

**INTECH**  
open science | open minds

### **InTech Europe**

University Campus STeP Ri  
Slavka Krautzeka 83/A  
51000 Rijeka, Croatia  
Phone: +385 (51) 770 447  
Fax: +385 (51) 686 166  
[www.intechopen.com](http://www.intechopen.com)

### **InTech China**

Unit 405, Office Block, Hotel Equatorial Shanghai  
No.65, Yan An Road (West), Shanghai, 200040, China  
中国上海市延安西路65号上海国际贵都大饭店办公楼405单元  
Phone: +86-21-62489820  
Fax: +86-21-62489821



© 2012 The Author(s). Licensee IntechOpen. This is an open access article distributed under the terms of the [Creative Commons Attribution 3.0 License](#), which permits unrestricted use, distribution, and reproduction in any medium, provided the original work is properly cited.

IntechOpen

IntechOpen