

We are IntechOpen, the world's leading publisher of Open Access books Built by scientists, for scientists

5,500

Open access books available

135,000

International authors and editors

165M

Downloads

Our authors are among the

154

Countries delivered to

TOP 1%

most cited scientists

12.2%

Contributors from top 500 universities



WEB OF SCIENCE™

Selection of our books indexed in the Book Citation Index
in Web of Science™ Core Collection (BKCI)

Interested in publishing with us?
Contact book.department@intechopen.com

Numbers displayed above are based on latest data collected.
For more information visit www.intechopen.com



The Interaction Between the Metabolism of Retinol and Ethanol in Esophageal Mucosa – A Possible Mechanism of Esophageal Cancer in Alcoholics

Hirokazu Yokoyama, Haruko-Shiraishi Yokoyama and Toshifumi Hibi
*Department of Internal Medicine, Keio University
Japan*

1. Introduction

It has been well established that excessive ethanol consumption is associated with an increased risk of cancers in various organs (Bann et al. 2007). It is estimated that alcohol consumption accounts for 3.6% of all cancer cases and 3.5% of cancer deaths in the world (Boffetta et al. 2006). However, the mechanisms by which ethanol causes cancer remains obscure.

Recently, aberrant statuses of retinoids, which are structurally and/or functionally related to vitamin A (retinol), have been implicated in the pathogenesis of some types of cancers. It is well established that, at least in natural conditions, retinoic acids (RAs) are mainly responsible for retinoid actions among various retinoids. A current consensus is that RAs are supplied via retinol metabolisms *in vivo*.

Both retinol and ethanol are types of alcohol. Thus, features of their metabolic pathways are similar to each other. The aim of this chapter is to summarize the latest knowledge on the supply pathway of RA *in vivo* and that on carcinogenesis due to short supply of RA. Moreover, we recently suggested that *in situ* RA supply was disturbed by ethanol metabolism in esophageal mucosa, and hypothesized that this could account for the pathogenesis of esophageal cancer seen in alcoholics. In this chapter, we also discussed how this hypothesis could be fit to the clinical characteristics of esophageal cancer seen in alcoholics. Since many of the views introduced in this chapter are obtained from animal models, we must interpret them carefully. However, we believe that most of these views are fully applicable for clinical cases.

2. Cancers in heavy drinkers and their characteristics

2.1 Organ specificities in cancers related to ethanol consumption

Many reports suggest that ethanol consumption could be a risk factor for malignancies of multiple organs (Alcohol and Cancer- Wikipedia, http://en.wikipedia.org/wiki/Alcohol_

and_ cancer). However, the current consensus, established by a meeting of the International Agency for Research on Cancer (IARC) in 2007, is as follows: Alcohol beverages are definitely carcinogenic to humans and they contribute to the development of human cancers in the oral cavity, pharynx, larynx, esophagus, liver, colorectum, and the female breast, but they are not related to the development of human renal cell cancer and non-Hodgkins lymphoma (Bann et al. 2007). Currently, it is acceptable to assume that alcoholic beverages could be carcinogenic but there are apparent organ specific susceptibilities to the carcinogenicity of ethanol, and the esophagus is one of these susceptible organs.

2.2 Genetic variations and cancers related to ethanol consumption

Imbibed ethanol is metabolized mainly by an NAD-dependent mechanism *in vivo*. In this pathway, ethanol is oxidized to acetaldehyde, which is further oxidized to acetate (Lieber 1984). This process is performed mainly in the liver where alcohol dehydrogenase 1 (ADH1), comprising ADH1A, 1B, and 1C, is responsible for ethanol oxidation to acetaldehyde and aldehyde dehydrogenase 2 (ALDH2) is responsible for acetaldehyde oxidation to acetate. Among these enzymes, genetic variations of ADH1C and ALDH2 are known to affect ethanol metabolism. ADH1C includes two polymorphisms i.e., ADH1C*1 and ADH1C*2, encoding $\gamma 1$ and $\gamma 2$ subunits, respectively. The K_{cat} values for ethanol of $\gamma 1\gamma 1$ and $\gamma 2\gamma 2$ isoforms were shown to be 87 min^{-1} and 35 min^{-1} , respectively (Bosron and Li, 1987), indicating that the former catalyzes ethanol faster than the latter, such that the former produces larger amounts of acetaldehyde than the latter during a constant period when they encounter the same amount of ethanol. On the other hand, ALDH2 also includes two distinct polymorphisms i.e. ALDH2*1 and ALDH2*2, and the latter encodes a variant subunit of ALDH2 lacking catalytic activity for acetaldehyde. This variant is often seen in Asians but is rare in other races (Goedde, 1992). Most homozygous carriers of this allele are non-drinkers, since they can not oxidize acetaldehyde and can not complete ethanol metabolism *in vivo*. Thus, they are hardly exposed to the harmful effects associated with ethanol consumption including carcinogenesis. Heterozygous carriers of ALDH 2*1 / 2*2, who account for around 40% of the population in some Asian countries, including Japan, can consume alcohol beverages. However, since the catalytic activity for acetaldehyde in the heterozygous carriers is around 10% of that of homozygous carriers of ALDH2*1/2*1 (Thomasson et al. 1993), significant acetaldehyde accumulation, of which symptoms are represented by the flushing phenomenon, occurs after drinking. Importantly, the risks of several cancers, including esophageal cancer seen in alcoholics, have been reported to be higher in alcoholics having the variant ADH1C*1 (Homann et al. 2006) and ALDH2*2 (Yokoyama et al. 1996). However, contradictory findings have also been published for the ADH1C*1 variant (Brennan et al. 2004) and a consensus statement of a meeting of IARC in 2007 only accepted a higher risk of cancer in subjects with the ALDH2*2 variant (Bann et al. 2007). At any rate, genetic differences in ethanol-oxidizing enzymes, which alter *in vivo* acetaldehyde levels after drinking affect the incidence of cancers in alcoholics.

2.3 Field cancerization in cancer related to ethanol consumption

The concept of field cancerization has been recognized. Namely, during the development of some cancers, such as that in aerodigestive organs, some genetic alterations which are

peculiar to cancer cells occur not only in cancer cells, but also in non-cancer cells adjacent to the malignant tumor, or in advanced pre-malignant lesions in cancer-free patients (Hong et al. 1995). Alteration of the p53 gene and accumulation of its protein are typical observations seen in field cancerization (Shin et al. 1994). The fact that a mutated p53 protein has a longer half-life compared to that of wild-type p53 may account for its accumulation (Gao et al. 1994). The field cancerization has been confirmed in human esophageal mucosa (Gao et al. 1994), and furthermore, in that of alcoholics (Yokoyama et al. 2011). Namely, it is fully expected that esophageal cancer develops in a manner of field cancerization in some alcoholics..

2.4 Animal models of cancers related to ethanol consumption

There are several lines of animal models demonstrating the carcinogenicity of ethanol, however, in most models, cancers were produced by the combination of ethanol and other carcinogens. Notably, Sofferitti et al. demonstrated that the administration of 10% ethanol ad libitum for 104-152 weeks alone could produce cancers in Sprague-Dawley rats, including breeders and offspring. They demonstrated that ethanol consumption increased the risk of head and neck cancers. However, other cancers, which were induced by this model, were different from those seen in human alcoholics, for example, interstitial cell adenocarcinoma of the testis, Sertoli cell tumor in the ovary, uterus carcinoma, pheochromoblastoma, and head osteosarcoma (Soffritti et al. 2002). Moreover, at least in their model, ethanol administration did not affect the incidence of cancers of the esophagus, lung, colorectum, breast, and liver, which are now regarded as related to ethanol consumption in humans (Bann et al. 2007). These observations indicate that ethanol is also carcinogenic in the rat, however, the features are different from those in humans. There seems to be strain specific susceptibilities to the carcinogenicity of imbibed ethanol. On the other hand, one paper demonstrated that the administration of acetaldehyde vapour produced various lesions in the respiratory epithelium including squamous metaplasia and squamous cell carcinoma (Feron et al. 1986).

3. *In vivo* dynamics of vitamin A for the production of RA

Molecules which are structurally and/or functionally related to vitamin A (retinol) are called retinoids. Presently, over 4000 retinoids including natural and synthetic ones have been identified. They are biologically important since they participate in the regulation of various phenomenon of life. Since mammals can not synthesize retinoids *in vivo*, they must take them from foods. The current consensus is that the effects of retinoids are mainly attributable to retinoic acids (RAs). In spite of the large demands for RAs in tissues, its serum level has been reported to be just 2-3 ng/ml (Moulas et al., 2006). This level was too low to satisfy all *in vivo* demands, suggesting the existence of a compensatory supply system *in situ*. And, recently, it became clear as to how RAs were produced from retinol *in situ*. The following is a summary of recent knowledge as to *in vivo* retinoid dynamics.

3.1 Absorption, storage, and delivery of retinol to a target cell

Food contains retinol, retinyl ester, and β -carotene, which are absorbed in the small intestine. When intestinal epithelial cells absorb retinyl esters, they are converted into retinol

via retinyl ester hydrolase (REH) *in situ*. β -carotene is cleaved to retinal via β - β -carotene-15,15' monooxygenase and the retinal formed is converted into retinol via retinol dehydrogenase. Retinol, then, binds to cellular retinol binding protein (CRBP), which contributes to the stabilization of retinol and its solubilization in the aqueous phase. In turn, this complex is converted to retinyl esters via lecithin retinol acetyltransferase (LRAT). Retinyl esters formed are released into blood vessels and transported to the liver. In hepatocytes, retinyl esters are converted into retinol via REH, and the retinol forms a retinol-CRBP complex with CRBP. A part of this complex is transported to hepatic stellate cells, which are major storage sites of retinol *in vivo*. There, the retinol-CRBP complex is converted to retinyl esters again via LRAT for storage. Upon *in vivo* requests for retinol, they are converted back to the retinol-CRBP complex via REH, which is returned to the hepatocytes. Recently, *Bcmo1*, an enzyme, which participates in β -carotene metabolism, was shown to be highly expressed in hepatic stellate cells, suggesting that they also contribute to β -carotene metabolism (Shmarakov 2010). Further studies are necessary to clarify the significance of this enzyme in stellate cells. In hepatocytes, CRBP of the retinol-CRBP complex is converted to serum retinol-binding protein (sRBP or RBP4). The retinol-RBP4 complex is released from the liver into blood vessels, and is delivered to retinoid target cells. In blood vessels, transthyretin (TTR) binds to the retinol-RBP complex, preventing efflux of the complex from the kidney. These features are summarized in Figure 1.

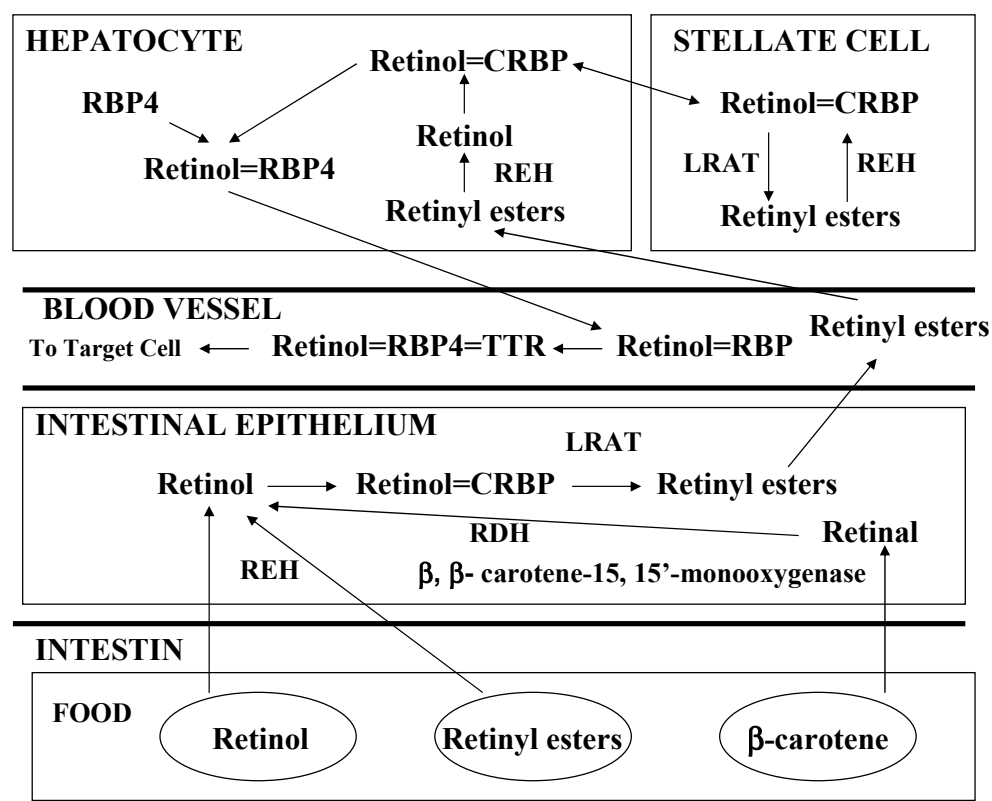

Retinol, retinyl esters, and β -carotene in food are absorbed mainly by the small intestine and stored in hepatic stellate cells. Retinol binds to retinol binding protein (RBP) -4 in the liver and transthyretin (TTR) in blood vessels and is delivered to target cells. [CRBP; cellular retinol binding protein, RDH; retinol dehydrogenase LRAT; lecithin retinol acetyltransferase, REH; retinyl ester hydrolase]

Fig. 1. Absorption, storage, and delivery to a target cell of retinol.

3.2 RA formation from retinol in RA target cell

A cell which requires RA, namely a RA target cell usually expresses a receptor for RBP4, named “stimulated by retinoic acid 6 (STRA6)”, on its surface and their combination allows for the retinol-RBP4-TTR complex to bind to the cell surface. From the complex, the cell incorporates only retinol by the action of LRAT. A part of free retinol binds to CRBP, forming a retinol-CRBP complex in the cell. Since the CRBP-1 gene has a binding site for RAR- α at its promoter region, it may be up-regulated by RA, suggesting that the protein contributes to retinol storage when RA is over supplied in the cell. On the other hand, free retinol is converted to RA via a two step oxidation process in which retinol is first oxidized to retinal via retinol dehydrogenase (RDH), and is then oxidized to RA via retinal dehydrogenase (RalDH). The formed RA binds to a cellular RA binding protein (CRABP), which may contribute to RA storage in the cell. The formation of a RA-CRABP complex may also facilitate the migration of RA from the cytosol into the nucleus, and the formation of RA-RAR receptor complex binding to RA target genes. Free RA is further catalyzed to 4-hydroxyl-retinoic acid (4-OH-RA), 18-hydroxy-retinoic acid (18-OHRA), 4-oxo-retinoic acid ((4-oxo-RA), and 5,6-epoxy-retinoic acid (5,6-epoxy-RA) in the cell via Cyp26A, B, and C, enzymes of a P450 family. Among these RA metabolites, 4-oxo-RA has been shown to have RA activity (Baron et al.). These features are summarized in Figure 2.

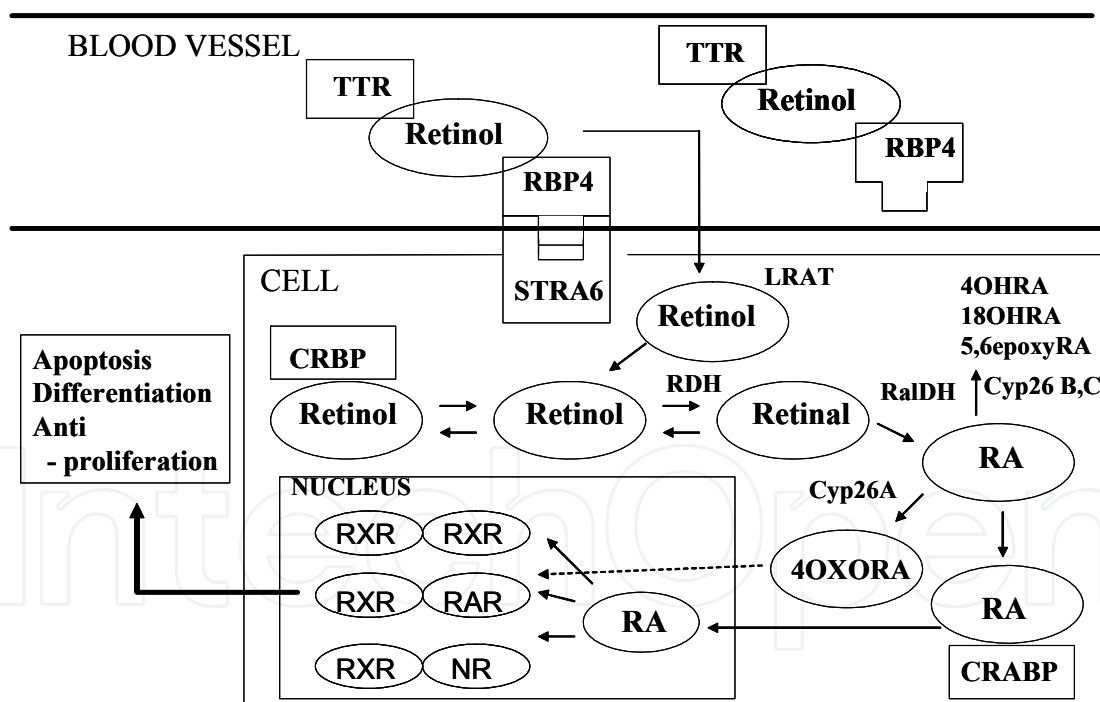

A cell incorporates retinol from a Retinol-RBP4-TTR complex in blood vessels via STRA6. Retinol is metabolized to retinoic acid (RA) via a two step oxidation process. RA binds to a cellular retinoic acid binding protein (CRABP), and is transferred into the nucleus, when it exhibits its action. 4-oxo-RA, a metabolite of RA, may also have a RA effect. [CRBP; cellular retinol binding protein, RDH; retinol dehydrogenase RalDH; retinal dehydrogenase, RBP4; retinol binding protein 4, TTR; transthyretin, LRAT; lecithin retinol acetyltransferase]

Fig. 2. Retinoic acid formation from retinol in a retinoic acid target cell.

4. RA and gene expression

4.1 RA receptors

When RA is transported into the nucleus, it binds to RA receptors which usually bind to the promoter regions of RA target genes. They comprise two classes, i.e. retinoic acid receptors (RAR) and retinoid X receptors (RXR), and each comprises three subtypes designated as α , β , γ , respectively. Furthermore, each subtype has several isoforms, namely two isoforms of RAR α ($\alpha 1$, $\alpha 2$), five isoforms of RAR β ($\beta 1$ – $\beta 4$ and $\beta 1'$), two isoforms of RAR γ ($\gamma 1$, $\gamma 2$), and two isoforms of RXR α ($\alpha 1$, $\alpha 2$), two isoforms of RXR β ($\beta 1$, $\beta 2$), and two isoforms of RXR γ ($\gamma 1$, $\gamma 2$). RARs have affinity to *all-trans* and *9-cis* RA, and RXRs have affinity to *9-cis* RA. They show cDNA sequence homology with receptors of vitamin D, glucocorticoid, and estrogen. RXR can form homodimers with RXR and heterodimers with RAR. Furthermore, RXR can form heterodimers with peroxisomal proliferation activated receptors (PPAR), farnesoid X receptors (FXR), liver X receptors (LXR), pregnant X receptors (PXR), constitutive androstane receptors (CAR), and vitamin D receptors (VDR). In these cases, RA, especially *9-cis* RA, may regulate gene expression with the other regulators which are originally required by partner receptors, namely fatty acid, bile acid, oxysterol, some xenobiotics, vitamin D, and their analogs, except for the cases where RXR is non-functional. Notably, the RXR-RXR homodimer was shown to activate PPARs (Ijpenberg et al.2004)

4.2 Gene regulation by RA

RA regulates gene transcription via multiple mechanisms. The simplest way is that RA directly affects transcription of the target gene via RA receptors. The hetero- or homo- dimer of RA receptors, i.e., RXR-RXR, RAR-RAR, or RXR-RAR, binds to the RA DNA Response Element (the specific sequence of GGTCA(N5)AGTCA, RARE), usually located at the promoter region of the target gene. When RA and co-activators, such as the pCIP/p300 complex, binds to the dimer, gene transcription starts under the presence of RNA polymerase II. This condition is schematically illustrated in Figure 3.

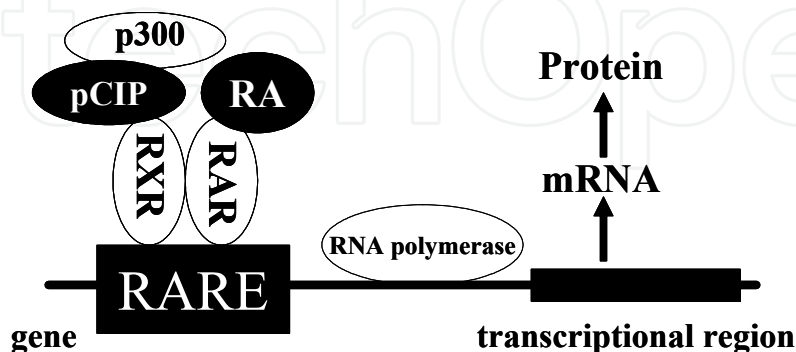

When RA binds to RARE, located at the 5' region of a gene via RA receptors, gene transcription starts. For this event, co-activators, such as a pCIP/p300 complex and RNA polymerase II, are required.

Fig. 3. Regulation of gene transcription by RA (1).

There are several lines of evidence to suggest that the functions of RARs are also regulated by their phosphorylation statuses. The enzymes responsible for their phosphorylation processes remain obscure. However, observations suggest that regulation of gene transcription by RA is not a simple event in such a simple model. The identification of enzymes responsible for this process will provide further information as to how RAs regulate gene expressions.

Sometimes, RA can regulate the expression of some genes lacking RARE. Namely, RA regulates the expression of a transcriptional factor, such as Hox1, which regulates that of another gene, as illustrated in Figure 4.

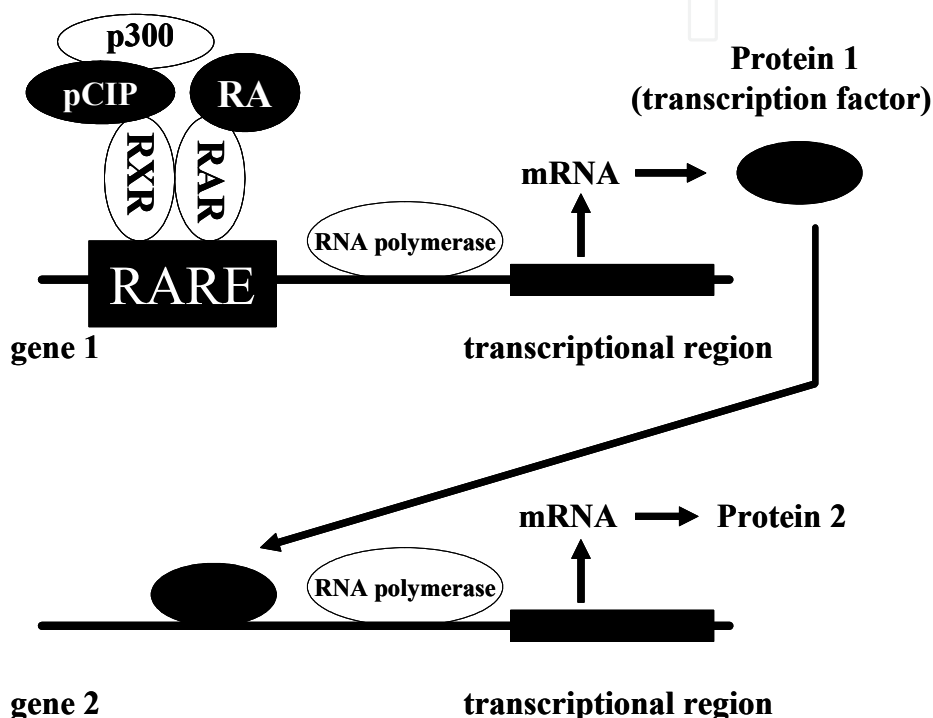

Some transcriptional factors are produced from some RA-regulated genes (gene 1). When the transcriptional factor binds to the binding site on another gene (gene 2), its transcription starts and protein 2 is produced. In this case, protein 2 is thought to be RA regulated.

Fig. 4. Regulation of gene transcription by RA (2).

The transcription of some genes is regulated by polycomb group proteins (PcG, Simon and Kingston 2009). Although it is still unclear how PcGs recognize their specific sites on DNA, they bind to some regions on their target gene. In this situation, co-activators, such as the pCIP/p300 protein, can not bind to retinoid receptors binding to the gene, and gene translation does not occur. Gillespie and Gudas demonstrated that RA regulates this PcGs-DNA binding. Namely, when RA binds to the RAR-RXR complex, which binds to RARE sometimes located at the 3' region of the gene, PcGs are removed from the gene, facilitating the binding of the gene co-activator(s), starting gene transcription (Figure 5). They demonstrated that the RAR γ -RXR-RA complex exclusively exhibits such an action, but not others. Expressions of Cyp26a1, and RAR β 2 are known to be controlled in this way (Gillespie and Gudas 2007).

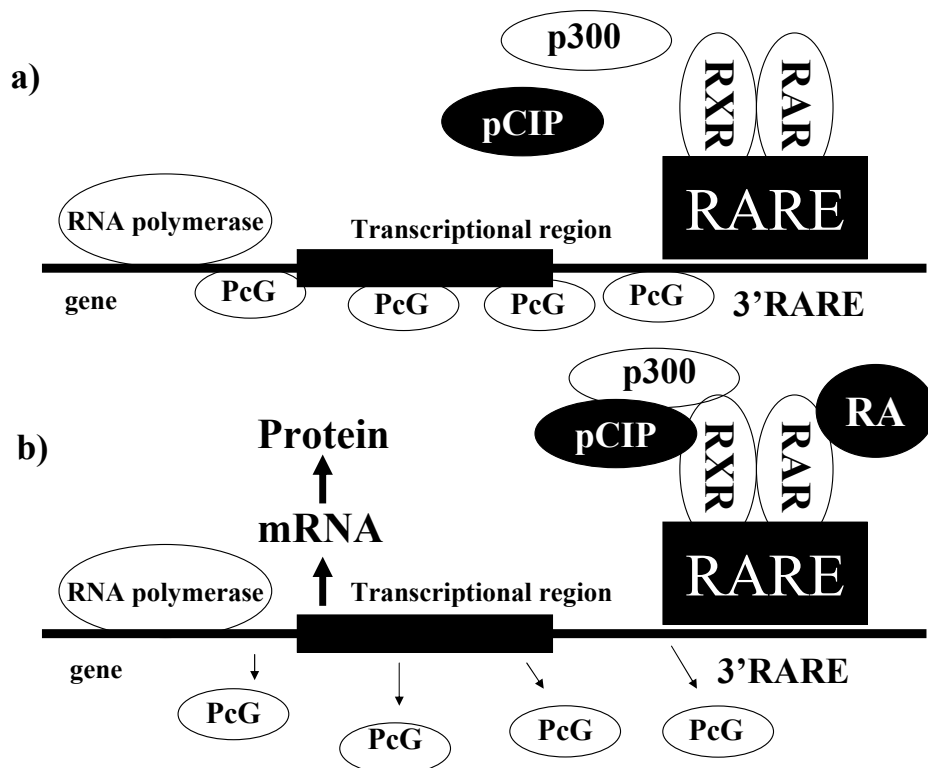

Transcription of some genes is regulated by RA via the polycomb group proteins (PcGs) status. In such a gene, transcription does not occur without RA since PcGs binding to the gene inhibit its transcription (a). However, when RA makes a complex with its receptor, and the complex binds to the RARE of the gene which is usually located at its 3' region, PcGs are removed from the gene, allowing the binding of co-factors to the gene via the retinoid receptor, and its transcription starts (b). (modified from a figure from Gillespie and Gudas 2007)

Fig. 5. Regulation of gene transcription by RA via PcGs.

5. Retinoids and cancer

When vitamin A, a major source of RAs, is depleted, metaplasia of squamous cells occurs (Harris et al. 1972, Lotan et al. 1993). In clinical cases, vitamin A deficiency has been implicated in the development of esophageal cancer (Mellow et al. 1983). *In vitro* studies clearly demonstrated that retinoids inhibit cell proliferation of normal cells (Lee et al. 1995). The current consensus is that normal differentiation and proliferation of the cell are spoiled when intercellular homeostasis of retinoids is disturbed (Zou et al. 1994). Apparently, an abnormal retinoid status is related to carcinogenesis. Therefore, it is not surprising that the administration of retinoid prevents the development of squamous cell carcinoma in the skin, oral cavity, and lung in animal models (Moon et al. 1994). Notably, some synthetic retinoids were reported to be effective in preventing the development of esophageal cancer from severe esophageal squamous dysplasia (Han 1993).

Retinoids also act against malignant cells. They suppress the growth rate of various tumor cells including melanoma, neuroblastoma, glioma, retinoblastoma, embryonal carcinoma, lymphoma, leukemia, myeloma, various sarcoma, as well as cancers of the breast, prostate, bladder, colon, head and neck, and cervix. Most malignancies develop based on the

complicated accumulation of various events including genetic alterations, dysregulation of cell growth, abnormal cell differentiation, and changes in the phenotype and cell function. Retinoids may be involved in all of these steps and usually exhibit anti-cancer effects.

5.1 Retinoids and apoptosis

It is well established that retinoids induce apoptosis and cell cycle arrest in some malignant cells. *All-trans* retinoic acid (ATRA) has been known to produce p53 dependent apoptosis in promyelocytic leukemia HL-60 cells (Noguchi et al. 1995). Moreover, a synthetic retinoid up-regulated the expression of p21 (WAF1/CP1), Bax, and Killer/DR5, resulting in cell-cycle arrest of the G1 phase and apoptosis in human non-small cell lung cancer cell. These phenomena were observed only in cell lines having a wild type of p53, but not in those with mutant p53, indicating that they were p53 dependent (Sun et al. 1999a). On the other hand, retinoids were shown to produce cell-cycle arrest of the G0/G1 phase and apoptosis in a p53 independent manner in human breast cancer cells (Shao et al. 1995). Apoptosis due to retinoids via the BCL2 pathway in orbital fibroblasts (Pasquali et al. 2003), via caspase-3 in esophageal squamous cells (Wan et al. 2001), and via CPP32-like caspase in lung non-small cell carcinoma (Sun et al. 1999b) have been also demonstrated. In addition, c-Myc and its downstream genes have been shown to be involved in apoptosis caused by a synthetic retinoid in human lung cancer cell (Sun et al. 1999c). The mitogen-activated protein kinase (MAPKs) pathway is now recognized as an important cascade regulating the expressions of various genes related to apoptosis and cell proliferation. RA also activates MEK-dependent ERK2, a member of the MAPK family, and subsequent RB hypophosphorylation, resulting in cell differentiation and G0 arrest in the myeloid leukemia cell line (Yen et al. 1998).

Obviously, retinoids have the potential to produce apoptosis in various cells, resulting in the reduction of cell growth. Thus, it is fully conceivable that an RA deficiency causes the reduction of cellular apoptosis, which may cause carcinogenesis. Although the mechanisms as to how retinoid causes apoptosis have not been unified, differences in experimental conditions, including characteristics of target cells, structures of retinoids used, and amounts of retinoids used, may account, at least in part, for this complexity.

5.2 Retinoids and cell differentiation

Retinoids maintain proper differentiation in normal cells at physiological doses as well as restore demolished regulation of differentiation and/or cell growth of certain malignant or pre-malignant cells at pharmacological doses. At any rate, they usually enhance cell differentiation (Gudas et al. 1994). RA signals via RAR- β 2 seem to be responsible for the maintenance of normal cell differentiation in epithelial cells. RAR- β 2 signals are known to suppress the expression of EGFR (or ErbB-1). Thus, its reduction causes over expression of EGFR and its downstream proteins comprising activating protein-1 (AP-1) and COX-2, resulting in the disturbance of normal cell differentiation. The RAR- β 2 signals are also known to attenuate the phosphorylation of extracellular signal-regulated protein kinases 1 and 2 (Erk1/2), contributing to the down-regulation of AP-1 in esophageal cancer cells (Li et al. 2002). Recently, a new protein named retinoid receptor induced gene 1 (RRIG1), mediating the anticancer effects of RAR- β 2, was cloned from esophageal cells. When its expression is maintained, the expression of RhoA and its downstream proteins including

Cyclin D1, the phosphorylation of Erk1/2, and COX-2 are suppressed. RhoA also causes f-actin formation which induces colony formation, invasion, and proliferation of cells. Suppression of RhoA is required to keep these malignant characteristics in stationary states. When RRG1 expression is attenuated using its antisense mRNA, these malignant characteristics were induced in esophageal squamous cancer cell lines (Liang et al. 2006).

Preservation of cell-cell communication is an important characteristic for maintaining normal cell differentiation. Retinoids induce expression of connexin 43, a gap junction protein, contributing to the maintenance of cell-cell communication (Rogers et al. 1990). Retinoids also participate in the maintenance of gene expression of various extracellular matrix proteins, including integrins, laminin (Ross et al. 1994), and hyaluronic acid (Kim et al. 2010) to prevent the transformation of normal cells. RA signals via RAR- β may participate in the expression of several cell adhesion proteins, such as LSAMP which has anti cancer effects, and PCDH11Y which guides normal development (Wallden et al. 2005).

5.3 Retinoids and anti cancer effect via immunity

Retinoids also exhibit anti tumor effects via immunological mechanisms. Treatment of tumors with ATRA resulted in increased sensitivity to CTL and NK-cell-mediated lysis via MHC class I (Santin et al. 1998, Thompson et al. 2006). ATRA administration was shown to enhance apoptosis induced by IFN- γ in human glioblastoma cells. IFN- γ causes expression of HLA class II and HLA-DM molecules, and expression levels become higher when cells are treated with ATRA. Apparently, ATRA contributes to the production of apoptosis via the class II-mediated immune system (Haque et al. 2007). Recently, upregulation of HER2 (or ErbB-2) is implicated in the carcinogenesis of some cancers. IFN γ is known to downregulate HER2 oncoprotein p185 and this may be an event explaining the anti cancer effect of IFN γ . Ou et al. demonstrated that IFN γ induces the expression of RRG1, which is responsible for the downregulation of the HER2 oncoprotein p185 in ovarian cancer cells. Thus, retinoids, which are essential factors for maintaining RRG1 expression, should be important in exhibiting the anti-cancer effect of IFN γ (Ou et al. 2008). Retinoids exhibit anti cancer effects not only via ErbB-1, as shown in section 5.2, but also ErbB-2.

RA signals via RAR- β 2 have been shown to increase the expression of tumor cell antigens, such as CTAG1, CTAG2, and those of RIG-1/DDX58, responsible for the innate immune response (Wallden et al. 2005). From this viewpoint, retinoids are also indispensable for the anti cancer effect via immunity.

5.4 Lack of RAR- β 2 expression and carcinogenesis

There is no doubt that RA has anticancer effects, however, some cancers exhibit RA resistance (Lippman and Davis 1997). Although the mechanisms behind this phenomenon are still obscure, the role of RAR- β 2, one of the RA receptor, is of major interest, recently. The importance of RAR- β 2 signals for anti cancer effects are mentioned in section 5.2 and 5.3, and recently, the relationship between suppression of RAR- β 2 expression and RA resistance was demonstrated in various cell lines established from cancers in the kidney, esophagus, lung, breast, and prostate. Importantly, when RAR- β 2 cDNA is compulsorily

expressed using an adequate vector in cancer cells lacking RAR- β 2 expression and acquiring RA resistance, they regain RA sensitivities (Houle et al. 1993). Furthermore, when COX-2, a downstream protein of RAR- β 2, was reduced in esophageal cancer cells exhibiting RA resistance, they recovered RA sensitivity (Song et al. 2005). On the other hand, when RAR- β 2 expression was compulsorily suppressed by its antisense, lung cancer developed in mice (Berard et al. 1996).

In clinical cases, the reduction of RAR- β 2 was observed in cancers of head and neck, esophagus, lung, breast, pancreas, cervix, and prostate. Interestingly, a lack of RXR- β expression is also observed in pre-malignant lesions in the oral cavity (Lotan et al. 1995) and the bronchus (Xu et al. 1999), as well as in morphologically normal cells adjacent to cancer cells (Widschwendter et al. 1997). It can be assumed that the alteration of RAR- β expression status is involved in the neoplastic transformation from normal cells, and these aspects are consistent with the concept of field cancerization which was mentioned in section 2.3. As also mentioned in section 2.3, where one of characteristic features of field cancerization is the accumulation of mutant p53 not only in malignant cells, but also in pre-malignant lesions. The reduction of RAR- β 2 has been also implicated in the accumulation of mutant p53 in some cancers. The accumulation of p53 in pre-malignant lesions in the oral cavity has been shown to be correlated with RA resistance, possibly due to a lack of RAR- β up-regulation (Lippman et al. 1997). Moreover, immortalized dysplastic cells of oral mucosa have been reported to be characterized by the accumulation of mutation p53, induction of hTERT mRNA, and a lack of RAR- β 2 and p16 expression (McGregor et al. 1997). Consequently, the same group concluded that the lack of RAR- β 2 and p16 expression are the only essential factors for this transformation process among these events, at least for their model (Muntoni et al. 2003).

Clinically, the preservation of RAR- β 2 expression is associated with a higher efficacy in RA treatment of premalignant lesions in oral mucosa (Lotan et al. 1995), and also with a better prognosis in neuroblastoma cases (Cheung et al. 1998).

The mechanisms which lie behind the reduction in RAR- β 2 expression still remain obscure. In a lung cancer cell line lacking RAR- β 2 expression, deletion of chromosome 3p, a site responsible for RAR- β 2, was observed (Geradts et al. 1993). However, this seems to be a rare case. On the other hand, Lin et al. found that the orphan receptor COUP-TF was essential for RAR- β 2 expression and the lack of COUP-TF caused a reduction in RAR- β 2 expression in some cancers (Lin et al. 2000). A recently prevailing view is that the lack of RAR- β 2 is attributed to epigenetic mechanisms, namely the unusual methylation status of the RAR- β 2 gene, and the aberrant acetylation or phosphorylation of the histone wrapping the gene (Widschwendter et al. 2000, Lewis et al. 2005, Bean et al. 2005). In addition, Lefebvre et al. have demonstrated that an alteration of the PI3K/Akt signaling pathway is involved in the abnormal phosphorylation of the RAR- β 2 histone, resulting in the loss of RAR- β 2 expression in the cell (Lefebvre et al. 2006).

Importantly, the genes of RAR- β 2 and RRIG1 constituting the RAR- β 2 pathway, are RA inducible genes. The fact that the expression of RAR- β 2 is regulated by RA via PcGs is mentioned in section 4.2. This suggests that cellular RA levels affect the expression of RAR- β 2 levels and the status of its downstream proteins. The reduction in RAR- β 2 expression has

been demonstrated in some tissues of rats fed with vitamin A deficient diet (Verma et al. 1992). Moreover, Xu et al. found that intercellular RA levels were lower in premalignant lesions of human oral mucosa compared to normal ones (Xu et al. 1995). These observations support the view that an RA deficiency causes the reduction in RAR- β 2 expression, which is closely related to carcinogenesis. (This section (5.4) was written referring to the review of Xu et al., 2007).

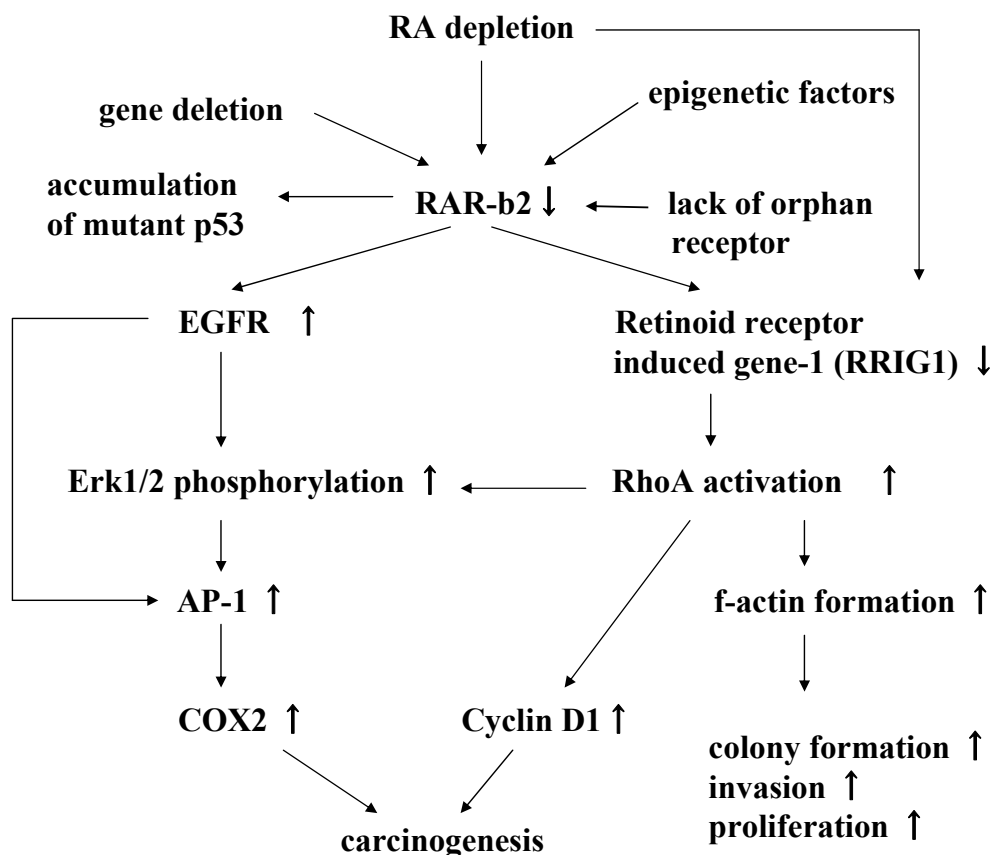

Reduction in RAR- β 2 is now assumed to be closely related to carcinogenesis in some organs. In addition, the reduction of RAR- β 2 is also implicated in the accumulation of mutant P53, which is often observed in some cancer cells and their premalignant regions. Multiple factors may affect RAR- β 2 expression. Since RAR- β 2 and RRIG1 are RA inducible genes, RA depletion is expected to reduce their expression, changing the features of their downstream proteins. A decrease in the RAR- β 2 signal increases expression of EGFR, and phosphorylation of Erk1/2, resulting in an increase in the expressions of AP-1 and COX-2. It also decreases the expressions of RRIG1, resulting in increases in RhoA and Cyclin D1. An increase in RhoA also causes Erk1/2 phosphorylation and COX2 activation. These changes cause carcinogenesis. In addition, RhoA is implicated in the activation of f-actin formation, resulting in colony formation, proliferation, and invasion of cells. (modified from a figure from Xu et al. 2007)

Fig. 6. Possible mechanisms for the development of cancer by RA depletion via a reduction in RAR- β 2 expression.

6. Structural and functional features of *the in situ* RA supply system in esophageal mucosa and its implication with the clinical aspects of esophageal cancer in alcoholics

As mentioned above, RAs are produced from vitamin A (retinol) in RA target cells *in situ* via a two step oxidation process, namely retinol is oxidized to retinal, a type of aldehyde, then retinal is oxidized to RA, a type of acid. The structural feature of this pathway is fundamentally the same as that of ethanol metabolism, in which ethanol is oxidized to acetaldehyde, a type of aldehyde, then acetaldehyde is oxidized to acetate, a type of acid. It is well established that the former pathway comprises retinol dehydrogenase (RDH) and retinal dehydrogenase (RaLDH), and the latter alcohol dehydrogenase (ADH) and aldehydedehydrogenase (ALDH).

6.1 Cloning of cDNA and gene of ADH7

Notably, there are several enzymes that have affinity for both retinol and ethanol or retinal and acetaldehyde and contribute to their oxidations such as human ADH 7, corresponding to Class IV ADH in rat. A study on the interaction between the metabolism of retinol and ethanol was opened by the findings of the existence of such enzymes. We cloned the cDNA (Yokoyama et al. 1994) of human ADH7 from a human gastric cDNA library and showed that it had 72% homology to human ADH1, a major ADH, on the cDNA level. We also cloned its gene and demonstrated that it was localized at 4q23-24 of the human genome, i.e. the ADH cluster (Yokoyama et al. 1996). These observations support the view that the enzyme is a member of the ADH family. We also found that the mRNA of ADH7 was exclusively expressed in human gastric mucosa among organs examined at that time (Yokoyama et al. 1995a). At present, ADH7 is known to be generally expressed in human upper digestive organs (Yin et al. 1993). We also reported SNP of ADH7 at exon 7 (Yokoyama et al. 1995b), however, its significance is still unknown. Recently, SNP at codon 92 of ADH7 cDNA (glycine/alanine change rs1573496) has been implicated in a higher incidence of head and neck cancer (Hashibe et al. 2008).

6.2 RA supply from vitamin A in the gastrointestinal tract

To know the significance of ADH7, we examined retinol metabolism in the esophagus and stomach using a high pressure liquid chromatography (HPLC) system by which 3 isoforms, i.e. *all-trans*, *9-sis* and *13-cis* of retinol, retinal, and RA were simultaneously quantified (Yokoyama et al. 2000). Subsequently, we established a new HPLC condition to quantify these isoforms more precisely (Miyagi et al. 2001, Figure 7). Using this technique, we demonstrated that RA could be produced when specimens of rat esophageal mucosa (Crabb et al. 2001) and human gastric mucosa (Yokoyama et al. 2001) were incubated with *all-trans* retinol in the presence of NAD. These pathways were designated as NAD-dependent *in situ* RA supply systems. Levels of RA production from retinol were shown to be dependent on ADH7 activities in human gastric mucosa (Matsumoto et al. 2001). We also demonstrated that *Helicobacter pylori* infection decreased the levels of ADH7 activities as well as the activity levels were inversely associated with the severity of morphological changes in the mucosa (Matsumoto et al. 2005).

6.3 Feature of an NAD dependent *in situ* RA supply system in rat esophageal mucosa

As ADH7, an NAD-dependent enzyme, is expressed in esophageal mucosa and has affinity to retinol, the enzyme is expected to contribute to the first step of an NAD-dependent *in situ* RA supply system in esophageal mucosa. Since ADH7 also has affinity to ethanol, it is postulated that ethanol can hamper the system in a competitive manner. When specimens of esophageal mucosa prepared from normal rats were incubated with retinol in the presence of NAD and various concentrations of ethanol, ethanol of 1 M or more was shown to attenuate RA production in the condition (Shiraishi-Yokoyama et al., 2003). The ethanol concentration which hampered the RA supply was comparable to the established K_m value for ethanol of rat Class IV ADH, i.e. at a molar level (Allali-Hassani et al., 1996), RA production was thought to be competitively disturbed in the model (Shiraishi-Yokoyama et al., 2003).

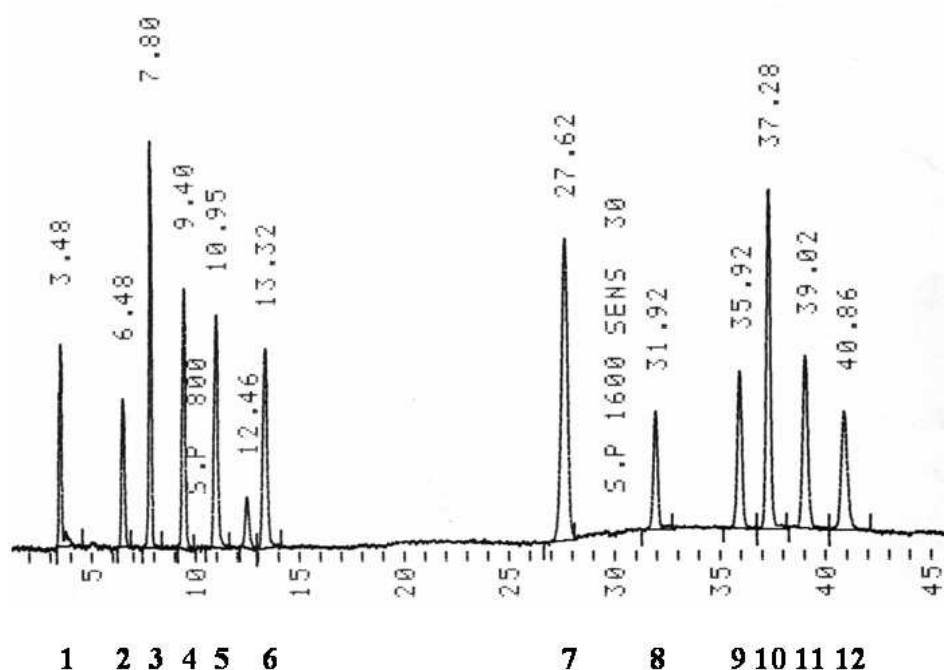

(1) 13-*cis* retinal, (2) 9-*cis* retinal, (3) all-*trans* retinal, (4) 13-*cis* RA, (5) 9-*cis* RA, (6) all-*trans* RA, (7) internal-standard, (8) 13-*cis* retinol, (9) all-*trans* retinol (10) all-*trans* 4-oxo RA, (11) 9-*cis* 4-oxo RA, (12) 13-*cis* 4-oxo RA. Various retinoid isoforms were successfully separated using a HPLC technique established in our laboratory. It allowed us to quantify them up to 2.5 ng/ml. The details are described in the article of Miyagi et al. 2001.

Fig. 7. Simultaneous quantification of various retinoids by a HPLC technique.

Using a similar experimental design, we also found that acetaldehyde of 50 μM and more hampered RA production from retinal in the esophageal mucosa of the rat, suggesting that an enzyme having affinity to both acetaldehyde and retinal participates in the second step of the NAD dependent *in situ* RA supply system in esophageal mucosa (Shiraishi-Yokoyama et al. 2006). One of the candidates having such characteristics was ALDH1A1, and this assumption was supported by our observation that the acetaldehyde concentration that hampered RA supply in the model was comparable to the reported K_m value for acetaldehyde of rat ALDH1A1, i.e. 30 μM (Crabb et al., 2004). This also supports the view that RA production was

competitively disturbed by acetaldehyde. The finding that catalytic activity for *all-trans* retinal of rat esophageal mucosa was 5.3 $\mu\text{M}/\text{min}$, which was consistent with that of rat ALDH 1A1 for *all-trans* retinal, i.e. 0.6-10 μM (Kathmann et al., 2000; Montplaisir et al., 2002), also suggested that RA production in the model was due to ALDH1A1.

We recently demonstrated that predominant ADHs in rat esophageal mucosa were Class I, III, and IV ADHs in mRNA levels (Yokoyama et al. 2010), which agreed with the expression pattern of ADHs in rat esophageal mucosa as examined in protein levels (Vaglenova et al. 2003). As Class IV ADH exhibits the highest affinity for retinol among these ADHs (Moreno and Pares, 1991), the view that Class IV ADH is involved in the NAD-dependent *in situ* RA supply system in rat esophageal mucosa is plausible. Moreover, we also demonstrated that the predominant ALDHs in rat esophageal mucosa were ALDH 1A1 and 3A1 in mRNA levels (Yokoyama et al. 2010). Since ALDH1A1 has the potential for catalyzing retinal to RA, whereas ALDH3A1 has no affinity for retinal (Yoshida et al., 1992, Bhat et al., 1996, Moore et al., 1998), this finding is compatible with the view that ALDH1A1 constitutes the NAD-dependent *in situ* RA supply system in rat esophageal mucosa.

We also confirmed that the expression levels of mRNA of both Class IV ADHs and ALDH 1A1 in the mucosal-layer of the rat esophagus were significantly higher than those in its muscle-layer (Yokoyama et al. 2010). Similar observations for Class IV ADH in the esophagus (Haselback and Duester, 1997, Vaglenova et al., 2003) and ALDH1A1 in the alveolar wall (Hind M et al., 2002) were reported. It is likely that the NAD-dependent RA supply system predominantly exists in the mucosal-layer, compared to the muscle-layer, in the rat esophagus and is supposed by the fact that a large quantity of RA is required in the epidermis compared to muscle (Randolph and Siegenthaler, 1999).

6.4 An NAD dependent *in situ* RA supply system in human esophageal mucosa

Since the expression pattern of isoforms of ADHs and ALDHs in human esophageal mucosa (Yin et al. 2003) is identical to that of the rat, it is postulated that an NAD-dependent *in situ* RA supply system whose structural feature is similar to that of rat esophageal mucosa exists in human esophageal mucosa, and responsible enzymes for the pathway are expected as ADH7 and ALDH1A, corresponding to rat Class IV ADH and ALDH1A1, respectively. When it is premised on this assumption, various clinical characteristics of esophageal cancers seen in alcoholics can be explained fairly satisfactorily.

The K_m value for ethanol of human ADH7 is 25mM (Kedishvili et al., 1995), markedly different from that of rat Class IV ADH. Since this ethanol level habitually appears in alcoholics, the first step of the NAD-dependent *in situ* RA supply system in the human esophagus could be hampered, causing a reduction in RA supply in them. It is of interest to know the effect of above mentioned ADH7 SNP rs1573496, which is implicated in the higher incidence of head and neck cancer (Hashibe et al. 2008), on RA supply. On the other hand, the K_m value for acetaldehyde of human ALDH1 is 41 μM (Kathmann et al., 2000), comparable to that of rat ALDH1A1. Importantly, acetaldehyde of such a level actually appears in alcoholics with the *ALDH 2*2* allele. This suggests that the second step of the NAD-dependent *in situ* RA supply system in the human esophagus is further hampered in such subjects (Figure 8).

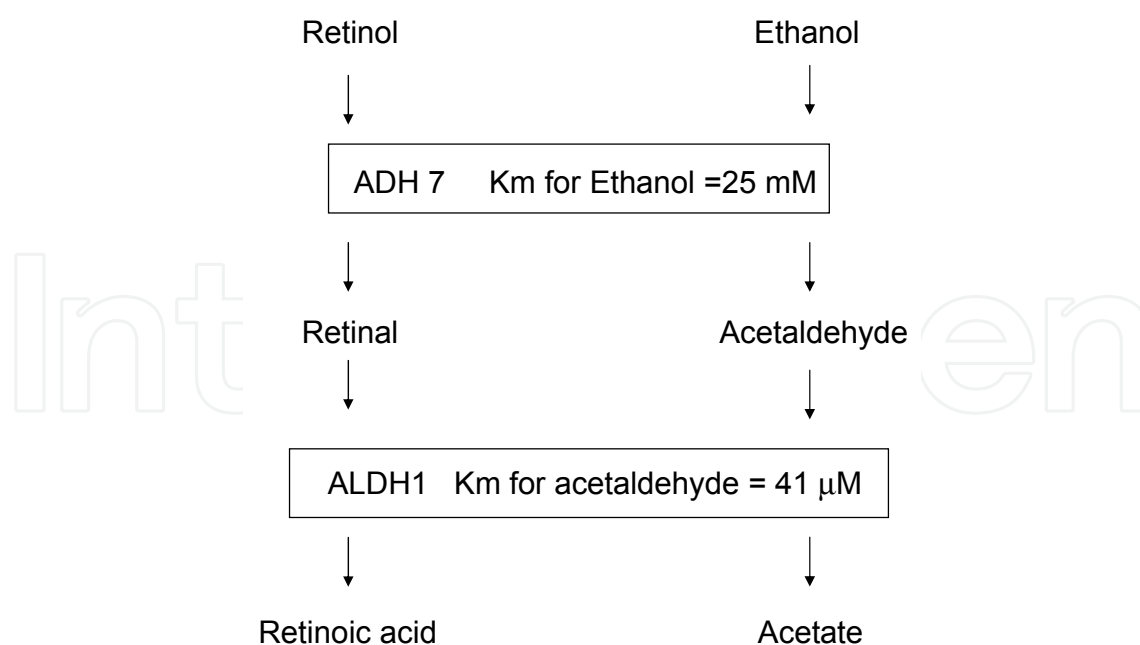

The *in situ* RA supply system in human esophageal mucosa may comprise ADH7 and ALDH1. Since they also have affinity for ethanol and acetaldehyde, respectively, the system may also participate in ethanol metabolism. Considering their Km values for ethanol and acetaldehyde, when esophagus is exposed to ethanol at a concentration of more than 25 mM, and acetaldehyde at a concentration of more than 41 μM, which can occur in alcoholics and in alcoholics with the ALDH2*2 allele, respectively, RA supply from retinol is hampered, resulting in the development of a RA deficiency. Importantly, multiple lines of evidence suggest that a RA deficiency causes carcinogenesis.

Fig. 8. Metabolism of retinol and ethanol via the *in situ* RA supply system in human esophageal mucosa.

6.5 Features of the *in situ* RA supply system in esophageal mucosa and clinical aspects of esophageal cancers related to ethanol consumption

In this chapter, the relationship between RA and carcinogenesis is summarized and we refer to the possibility that an intracellular RA deficiency leads to carcinogenesis. On the other hand, our observations that an NAD dependent *in situ* RA supply system comprising Class IV ADH and ALDH1A1 exists and ethanol metabolism hampers RA supply in rat esophageal mucosa are introduced. Moreover, we mention the plausibility that human esophageal mucosa also has a similar system comprising ADH7 and ALDH1A. Incorporating these views, our hypothesis is that RA supply in esophageal mucosa is hampered by excessive ethanol consumption and this is a causative factor in the development of esophageal cancer in alcoholics. In this section, whether this hypothesis can fit with the clinical characteristics of esophageal cancer in alcoholics is discussed.

6.5.1 The *in situ* RA supply system and organ specificities in cancers related to ethanol consumption

As mentioned in section 2.1, there are organ specificities in cancers related to ethanol consumption. The present hypothesis suggests that the *in situ* RA supply system in esophageal mucosa comprises ADH7 and ALDH1A, and ethanol metabolism hampers these

enzymes, resulting in a compromised intracellular RA level and the development of malignancy. It must be noted that this hypothesis can be applied to organs comprising RA target cells but not to those comprising non RA target cells. Moreover, several enzymes which have affinities for retinol and/or retinal but not for ethanol and/or acetaldehyde, such as families of p450, RDH, and retinal dehydrogenase (Lee et al. ,1991; Drager et al., 1998) has been identified. The present hypothesis can be neither applied to organs of which *in situ* RA supply systems comprise such enzymes since ethanol metabolism does not disturb RA supply in them. Thus, organ specificity of the structural feature of the *in situ* RA supply system may, at least in part, account for the organ specific susceptibilities to malignancy caused by ethanol consumption.

6.5.2 The *in situ* RA supply system and genetic variations in cancers related to ethanol consumption

In section 6.4, we discussed the possibility that ethanol and acetaldehyde of physiological concentrations may hamper the NAD-dependent *in situ* RA supply system in the human esophagus. This indicates that ethanol hampers RA supply via this system and acetaldehyde further affects it. This schema is compatible with the clinical feature that prevalence of esophageal cancer increases in alcoholics and is even higher in alcoholics carrying ALDH2*2 allele (Yokoyama et al. 1996), as described in section 2.2. A recently prevailing explanation as to how acetaldehyde causes esophageal cancer is that acetaldehyde binds to DNA and/or chromatin, forming an acetaldehyde adduct, thereby altering their functions (Yu et al. 2011). However, no distinct difference has been confirmed between esophageal cancers which develop in alcoholics with or without acetaldehyde accumulation, namely in those with or without the ALDH2*2 allele, suggesting that the esophageal cancers which develop in both types of alcoholics have a common pathogenesis. Thus, the hypothesis that both ethanol and acetaldehyde hamper the *in situ* RA supply system, causing carcinogenesis, is easier to accept than that a specific effect of acetaldehyde causes carcinogenesis.

6.5.3 The *in situ* RA supply system and field cancerization in cancer related to ethanol consumption

As emphasized in section 5.4, the reduction in RAR- β 2 gene expression has been shown to be related to carcinogenesis in various organs, including the esophagus. Furthermore, as mentioned in section 4 and 5, RA deficiency may cause this reduction in RAR- β 2 expression. Interestingly, a significant overlap is observed between cancers related to a lack of RAR- β 2 expression and those related to excessive alcohol consumption, as recognized by IARC (Table 1). This overlap is consistent with the present hypothesis that ethanol consumption disturbs the *in situ* RA supply system, resulting in the reduction of RAR- β 2 expression and carcinogenesis. As mentioned in section 2.3, some types of cancers in the esophagus develop via field cancerization. One of the distinct features of the field cancerization is the accumulation of mutant p53 not only in cancer cells, but also pre-malignant lesions. Such features were recently demonstrated in the esophageal mucosa of alcoholics (Yokoyama et al. 2011). As mentioned in section 5.4, the lack of RAR- β 2 expression has been implicated in the development of field cancerization as well as in p53 accumulation.

Cancers related to RAR- β 2 suppression (from statements of Xu et al. 2007)	Cancers related to alcohol consumption (from statements of Bann et al. 2007)
Oral cavity	Oral cavity
Head and neck	Head and neck
Esophagus	Esophagus
Brest	Brest
Lung	
Pancreas	
Prostate	
	Liver
	Colon and rectum

Table 1. Cancers related to RAR- β 2 suppression and alcohol consumption.

6.5.4 The *in situ* RA supply system and strain difference in susceptibility to ethanol with respect to carcinogenesis

As mentioned in section 2.4, thus far, there are limited animal models in which cancers were produced by ethanol administration alone. Although Soffritti et al. could produce multiple cancers in rats by ethanol administration for long periods (Soffritti et al. 2002), there was limited development of esophageal cancer in their model. Since the Km value for ethanol of rat Class IV ADH is a non-physiological level and accumulation of acetaldehyde does not usually occur in rats, it is expected that ethanol consumption does not hamper the *in situ* RA supply system in the esophageal mucosa of the rat and this can explain why ethanol alone does not produce esophageal cancer in their model. The structural feature of the *in situ* RA supply system may also account for the strain difference in susceptibility to ethanol with respect to carcinogenesis.

7. Conclusion

There is much evidence to show that reduction of RAs is associated with the development of malignancy. Most cancers must develop via multiple processes including genetic alterations, dysregulation of cell growth, differentiation, cell function, and cell loss, and change of cell phenotype, and RAs are involved in all these events. Furthermore, the reduction of RAs may down-regulate immune mechanisms against malignant cells. Among the multiple effects of RA, the relationship between the reduction of signals via RAR- β 2, one of the RA receptors, and carcinogenesis is of major interest lately. The current observations suggest that RA deficiency may reduce the expression of RAR- β 2.

In mammals, RA is synthesized from retinol, a type of alcohol, ingested from food. Recently, it has become clear that RA can be synthesized from retinol, which is delivered by blood vessels, via a two step oxidation pathway in a RA target cell. We recently demonstrated that such a pathway which can produce RA from retinol in an NAD dependent manner exists in rat esophageal mucosa, and designated it as an NAD dependent *in situ* RA supply system. Furthermore, we demonstrated that the pathway comprised Class IV ADH and ALDH1A1 and was hampered by ethanol, a substance of the former as well as by acetaldehyde, that of the latter. Considering the expression

patterns of ADH and ALDH in the human and rat esophagus, it is fully plausible that a similar pathway, one comprising ADH7 and ALDH1A exists in human esophageal mucosa. Since their Km values for ethanol and acetaldehyde are at physiological concentrations, we hypothesized that the metabolism of excessive ethanol consumption disturbs the pathway, resulting in a deficiency in RA, and the development of malignancy in esophageal mucosa. This hypothesis can account for clinical characteristics of cancers in alcoholics, including organ specificity, genetic specificity, and strain specificity. Moreover, this hypothesis is also compatible with the fact that esophageal cancer develops in a field cancerization manner in alcoholics. Further studies based on this hypothesis may be beneficial for understanding the pathogenesis of esophageal cancer seen in alcoholics, which must be important for having strategies of its prevention, diagnosis and treatment.

8. References

- Allali-Hassani, A.; Martinez, S.E.; Peralba, J.M.; Vaglenova, J.; Vidal, F.; Richart, C.; Farrés, J. & Parés, X. (1997). Alcohol dehydrogenase of human and rat blood vessels. Role in ethanol metabolism. *FEBS Letters*, Vol. 405, No.2-3 (July) pp.26-30.
- Bann, R.; Straif, K.; Grisse, Y.; Bouvard, V.; Altieri, A. & Coglianò, V. (2007) on behalf of the WHO International Agency for Research on Cancer Monograph Working Group Carcinogenicity of alcoholic beverages. *The Lancet Oncology*, Vol.8, No. 4 (April) pp 292-293
- Baron, J.M.; Heise, R.; Blaner, W.S.; Neis, M.; Joussen, S.; Dreuw, A.; Marquardt, Y.; Saurat, J.H.; Merk, H.F.; Bickers, D.R. & Jugert, F.K. (2005) Retinoic acid and its 4-oxo metabolites are functionally active in human skin cells in vitro. *The Journal of Investigative Dermatology*, Vol.125, No.1, (July) pp.143-153.
- Bean, G.R.; Scott, V.; Yee, L.; Ratliff-Daniel, B.; Troch, M.M.; Seo, P.; Bowie, M.L.; Marcom, P.K.; Slade, J.; Kimler, B.F.; Fabian, C.J.; Zalles, C.M.; Broadwater, G.; Baker, J.C. Jr.; Wilke, G. & Seewaldt, V.L. (2005). Retinoic acid receptor-beta2 promoter methylation in random periareolar fine needle aspiration. *Cancer, Epidemiology Biomarkers & Prevention*, Vol.142, No.4, (April) pp.790-798.
- Berard, J.; Laboune, F.; Mukuna, M.; Masse, S.; Kothary, R. & Bradley, W.E. (1996) Lung tumors in mice expressing an antisense RARbeta2 transgene. *The FASEB Journal*, Vol. 10, No.9, (July) pp. 1091-1097.
- Bhat, P.V.; Poissant, L. & Wang XL (1996) Purification of partial characterization of bovine kidney aldehyde dehydrogenase able to oxidize retinal to retinoic acid. *Biochemistry & Cell Biology*, Vol. 74, No.5, (May) pp. 695-700.
- Boffetta, P.; Hashibe, M.; La Vecchia, C.; Zatonski, W. & Rehm, J. (2006). The burden of cancer attributable to alcohol drinking. *International Journal of Cancer*, Vol. 119, No.4, (August) pp. 884-887
- Bosron, W.F. & Li, T.K. (1987) Catalytic properties of human liver alcohol dehydrogenase isoenzymes. *Enzyme*, Vol 37, No.1-2 (February) pp. 19-28.
- Brennan, P.; Lewis, S.; Hashibe, M.; Bell DA.; Boffetta, P.; Bouchardy, C.; Caporaso, N.; Chen, C.; Coutelle, C.; Diehl, S.R.; Hayes, R.B.; Olshan, A.F.; Schwartz, S.M.; Sturgis, E.M.; Wei, Q. & Zavras, A.I. Benhamou S. (2004) Pooled analysis of alcohol dehydrogenase genotypes and head and neck cancer: a HuGE review. *American Journal of Epidemiology*, Vol. 159, No.1, (January) pp. 1-16.

- Clifford J.L.; Menter D.G.; Wang, M.; Lotan, R. & Lippman, S.M. (1999) Retinoid Receptor-dependent and -independent Effects of *N*-(4-Hydroxyphenyl)retinamide in F9 Embryonal Carcinoma Cells *Cancer Research* Vol. 59, No.1 (January) pp.14-18,
- Cheung, B.; Hocker, J.E.; Smith, S.A.; Norris, M.D.; Haber, M. & Marshall G.M. (1998) Favorable prognostic significance of high-level retinoic acid receptor beta expression in neuroblastoma mediated by effects on cell cycle regulation. *Oncogene* vol. 17, No.6 (August) pp. 751-759,
- Crabb, D.W.; Bergheim, I.; Bosron, W.; Lieber, C.S.; Tsukamoto, H. & Yokoyama, H. Alcohol and Retinoids. (2001) *Alcoholism; Clinical and Experimental Research* Vol.25, No.5 Suppl 1 (May) pp 207S-217S,
- Drager, U.C.; Wagner, E. & McCaffery, P. (1998) Aldehyde dehydrogenases in the generation of retinoic acid in the developing vertebrate: A central role of the eye. *The Journal of Nutrition* Vol. 128, No.2 Suppl (February) pp. 463S-466S,
- Feron, V.J.; Kruijse, A. & Woutersen, R.A. (1982) Respiratory tract tumours in hamsters exposed to acetaldehyde vapour alone or simultaneously to benzo(a)pyrene or diethylnitrosamine. *European Journal of Cancer & Clinical Oncology* Vol 18, No.1 (January) pp.13-31,
- Gao, H.; Wang, L. D.; Zhou, O.; Hong, J. Y.; Huang, T. Y. & Yang, C. S. (1994) *p53* tumor suppressor gene mutation in early esophageal precancerous lesions and carcinoma among high-risk populations in Henan, China. *Cancer Research* Vol. 54, No.16 (August) pp. 4342-4346
- Geradts, J.; Chen, J.Y.; Russell, E.K.; Yankaskas, J.R.; Nieves, L. & Minna, J.D. (1993) Human lung cancer cell lines exhibit resistance to retinoic acid treatment. *Cell Growth & Differentiation* Vol. 4, No.10 (October) pp. 799-809
- Gillespie, R.F. & Gudas, L.J. (2007) Retinoid regulated association of transcriptional co-regulators and the polycomb group protein SUZ12 with the retinoic acid response elements of *Hoxa1*, *RARB*(2), and *Cyp26A1* in F9 embryonal carcinoma cells. *Journal of Molecular Biology* Vol. 372, No. 2 (September) pp. 298-316
- Goedde, H.W.; Agarwal, D.P.; Fritze, G.; Meier-Tackmann, D.; Singh, S.; Beckmann, G.; Bhatia, K.; Chen, L.Z.; Fang, B. & Lisker, R. (1992) Distribution of ADH2 and ALDH2 genotypes in different populations. *Human Genetics* Vol. 88, No.3 (January) pp. 344-366.
- Gudas, L. J.; Sporn, M. B. & Roberts, A. B. (1994). Cellular biology and biochemistry of the retinoids. In: *The Retinoids*, M. D. Sporn, A. B. Roberts, & D. S. Goodman (Ed), 443-520, Raven Press, New York, USA:
- Han J (1993). Highlights of the cancer chemoprevention studies in China. *Preventive Medicine* Vol 22, No.5 (September) pp. 712-722,
- Haque, N.; Banik I., & Ray S.K. (2007) Emerging role of combination of all-trans retinoic acid and interferon-gamma as chemoimmunotherapy in the management of human glioblastoma," *Neurochemistry Research*, Vol. 32, No. 12 (December) pp. 2203-2209,
- Harris C.C.; Sporn, M.B.; Kaufman, D.G. & Smith J.M. (1972) Histogenesis of squamous metaplasia in the hamster tracheal epithelium caused by vitamin A deficiency or benzol[α]pyrene-Ferric oxide. *Journal of the Nutrition Cancer Institute* Vol. 48, No.3 (March) pp. 743-761,

- Haselback, R.J. & Duester, G. (1997) Regional restriction of alcohol/retinol dehydrogenases along the mouse gastrointestinal epithelium. *Alcoholism; Clinical and Experimental Research* Vol. 21, No.8, (November) pp. 1484-1490
- Hashibe, M.; McKay, J.D.; Curado, M.P.; Oliveira, J.C.; Koifman, S.; Koifman, R.; Zaridze, D.; Shangina, O.; Wunsch-Filho, V.; Eluf-Neto, J.; Levi, J.E.; Matos, E.; Lagiou, P.; Lagiou, A.; Benhamou, S.; Bouchardy, C.; Szeszenia-Dabrowska, N.; Menezes, A.; Dall'Agnol, M.M.; Merletti, F.; Richiardi, L.; Fernandez, L.; Lence, J.; Talamini, R.; Barzan, L.; Mates, D.; Mates, I.N.; Kjaerheim, K.; Macfarlane, G.J.; Macfarlane, T.V.; Simonato, L.; Canova, C.; Holcátová, I.; Agudo, A.; Castellsagué, X.; Lowry, R.; Janout, V.; Kollarova, H.; Conway, D.I.; McKinney, P.A.; Znaor, A.; Fabianova, E.; Bencko, V.; Lissowska, J.; Chabrier, A.; Hung, R.J.; Gaborieau, V.; Boffetta, P. & Brennan, P. (2008) Multiple ADH genes are associated with upper aerodigestive cancers. *Nat Genet.* Vol 40 No.6 (Jun) pp. 707-709
- Hind M.; Coccoran, J & Maden, M (2002) Alveolar proliferation, retinoic synthesizing enzymes, and endogenous retinoids in the postnatal mouse lung. *American Journal of Respiratory Cell & Molecular Biology* Vol. 26, No.1 (January) pp. 67-73,
- Homann, N.; Stickel, F.; König I.R.; Jacobs, A.; Junghanns, K.; Benesova, M.; Schuppan, D.; Himsel, S.; Zuber-Jerger, I, Hellerbrand, C.; Ludwig D.; Caselmann, W.H. & Seitz HK (2006). Alcohol dehydrogenase 1C*1 allele is a genetic marker for alcohol-associated cancer in heavy drinkers. *International Journal of Cancer*, Vol 118, No.8 (April), pp.1998-2002.
- Hong W.K.; Lippman, S.M., Hittelman, W.N. & Lotan R. Retinoid Chemoprevention of Aerodigestive Cancer: From Basic Research to the Clinic. *Clinical Cancer Research*, Vol.1, No.7 (July) pp. 677- 686..
- Houle, B.; Rochette-Egly, C. & Bradley, W.E. (1993) Tumor-suppressive effect of the retinoic acid receptor beta in human epidermoid lung cancer cells. *Proceedings of the National Academic Science of USA*, Vol.90, No.3 (February) 985-989.
- Ijpenberg, A.; Tan, N.S.; Gelman, L.; Kersten, S.; Seydoux, J.; Xu, J.; Metzger, D.; Canaple, L.; Chambon, P.; Wahli, W. & Desvergne, B. (2004) In vivo activation of PPAR target genes by RXR homodimers. *The EMBO Journal*, Vol. 23, No.10, (May) ; 2083-2091,
- Kathmann, E.C.; Naylor, S. & Lipsky, J.J. (2000) Rat liver and Phenobarbital-inducible cytosolic aldehyde dehydrogenase are highly homologous protein that function as distinct isozymes. *Biochemistry*, vol. 39, No.36 (September) pp. 11170-11176,
- Kedishvili, N.Y.; Bosron, W.F.; Stone, C.L.; Hurley, T.D.; Peggs, C.F.; Thomasson, H.R.; Popov, K.M.; Carr, L.G.; Edenberg, H.J.; & Li, T.K. Expression and kinetic characterization of recombinant human stomach alcohol dehydrogenase. Active-site amino acid sequence explain substrate specificity compared with liver isozymes. *Journal of Biological Chemistry*, vol 270, No. 8 (August) pp 3625-3630.
- Kim, J.E.; Kim, B.; Kim, H.; Kim, H; Lee., J.D.; Kim H.J. & Cho, K.Y. (2010) Retinyl retinoate induces hyaluronan production and less irritation than other retinoids. *The journal of Dermatology*, Vol. 37, No.5 (May) pp. 448-454,
- Lee, M.O.; Manthey, C.L. & Sladek, N.E. (1991) Identification of mouse liver aldehyde dehydrogenases that catalyze the oxidation of retinaldehyde to retinoic acid. *Biochemical Pharmacology*, Vol. 42 No.6 (August) pp. 1279-1285,
- Lee P.P.; Lee, M.T.; Darcy, K.M.; Shudo, K & Ip, M.M. (1995) Modulation of normal mammary epithelial cell proliferation morphogenesis, and functional

- differentiation by retinoids: A comparison of the retinobenzoic acid derivative RE80 with retinoic acid. *Endocrinology*, No.4 (April) Vol. 136, pp. 1701-1717,
- Lefebvre, B.; Brand, C.; Flajollet, S. & Lefebvre, P. (2006) Down-regulation of the tumor suppressor gene RAR- β 2 through the PI3K/Akt signaling pathway. *Molecular Endocrinology*, Vol. 20, No.9 (September) pp. 2109-2121,
- Lewis, C.M.; Clea, L.R.; Bu, D.W L, Zöchbauer-Müller, S.; Milchgrub, S.; Naftalis, E.Z.; Leitch, A.M.; Minna, J.D. & Euhus, D.M. (2005) Promoter hypermethylation in benign breast epithelium in relation to predicted breast cancer risk. *Clinical Cancer Research*, Vol. 11, No.1 (January) pp. 166-172.
- Li M.; Song, S.; Lippman, S.M.; Zhang, X.K.; Liu, X.; Lotan R. & Xu, X.C. (2002) Induction of retinoic acid receptorbeta suppresses cyclooxygenase-2 expression in esophageal cancer cells. *Oncogene*, Vol. 21, No.3 (January) pp. 411-418.
- Liang Z.D.; Lippman S.M.; Wu T.T.; Lotan R. & Xu X.C. (2006) RRIG1 mediates effects of retinoic acid receptor beta2 on tumor cell growth and gene expression through binding to and inhibition of RhoA. *Cancer Res* Vol.66, No.14 (July) pp.7111-7118.
- Lin, B.; Chen, G.Q.; Xiao, D.; Kolluri, S.K.;Cao, X.; Su, H. & Zhang, X.K. (2000).Orphan receptor COUP-TF is required for induction of retinoic acid receptor beta, growth inhibition, and apoptosis by retinoic acid in cancer cells. *Molecular and Cellular Biology* Vol. 20, No.3 (February) pp. 957-970,
- Lieber, C.S. (1984) Alcohol and the liver: 1984 update. *Hepatology*. 1984 Vol 4, no.6 (November-December) pp. 1242-1260,
- Lippman, S.M. & Davies, P.J. (1997) Retinoids, neoplasia and differentiation therapy. *Cancer Chemotherapy and Biological Resoponse Modifiers* Vol. 17, pp. 349-362.
- Lotan, R. (1993) Retinoids and squamous cell differentiation. In: Retinoids in Oncology, W. K. Hong & R. Lotan (Ed.), pp. 43-72, Marcel Dekker, New York, USA
- Lotan, R.; Xu, X.C. ; Lippman, S.M., Ro, J.Y., Lee, J.S., Lee, J.J., & Hong, W.K. (1995) Suppression of retinoic acid receptor b in premalignant oral lesions and its upregulation by isotretinoin. *New England Journal of Medicine* Vol. 332, No.21 (May) pp. 1405-1410,
- Matsumoto, M.; Yokoyama, H.; Shiraishi, H.; Suzuki, H.; Kato, S. Miura, S. & Ishii H (2001) Alcohol dehydrogenase activities in the human gastric mucosa: Effects of Helicobacter pylori infection, gender, aging, and part of stomach. *Alcoholism Clinical and Expimental Reseach*, Vol.25, No.6 Suppl, (June) pp. 29S-34S,
- Matsumoto, M.; Yokoyama, H.; Suzuki, H.; Shiraishi-Yokoyama, H. & Hibi, T. (2005) Retinoic acid formation from retinol in the human gastric mucosa: role of class IV alcohol dehydrogenase and its relevance to morphological changes. *American Journal of Physiology Gastrointestinal & Liver Physiology* Vol. 289, No.3 (September) pp. G429-G433,
- McGregor, F.; Wagner, E.; Felix, D.; Soutar, D.; Parkinson, K.& Harrison, P.R. (1997) Inappropriate retinoic acid receptor-beta expression in oral dysplasias: correlation with acquisition of the immortal phenotype. *Cancer Research*, Vol. 57, no.18 (september) pp 3886-3889,
- Mellow, M.H.; Layne, E.A.; Lipman, T.O.; Kaushik, M.; Hosteler, C. & Smith, J.C., Jr (1983) Plasma zinc and vitamin A in human squamous carcinoma of the esophagus. *Cancer* Vol.51, No.9 (May) pp. 615-1620,

- Miyagi, M.; Yokoyama, H.; Shiraishi, H.; Matsumoto, M. & Ishii, H (2001), Simultaneous quantification of retinol, retinal, and retinoic acid isomers by high-performance liquid chromatography with a simple graduation. *Journal of Chromatography B Biomedical Science Application*, Vol.757, No.2 (June) pp.365-368,
- Moon RC, Mehta RG, Rao KVN. Retinoids and cancer in experimental animals. In: Sporn MB, Roberts AB, Goodmann DS, eds. *The Retinoids, Biology, Chemistry, and Medicine*, 2nd edn. New York: Raven Press, 1994; 537-96.
- Moore, S.A.; Baker, H.M.; Blythe, T.J.; Kitson, K.E.; Kitson, T.M.& Baker, E.N. (1998) Sheep liver cytosolic aldehyde dehydrogenase: the structure reveals the basis for the retinal specificity of class 1 aldehyde dehydrogenases. *Structure* Vol.6 No.12, (December) pp. 1541-1551
- Moreno, A. & Pares, X. (1991) Purification and characterization of a new alcohol dehydrogenase from human stomach. *J Biological Chemistry*, Vol. 266, No.2 (January) pp. 11228-11233.
- Moulas, A.N.; Gerogianni, I.C; Papadopoulos, D. & Gourgoilianis, K.I. (2006) Serum retinoic acid, retinol and retinyl palmitate levels in patients with lung cancer. *Respirology* Vol. 11, No.2 (March) pp. 169-174
- Muntoni, A.; Fleming, J.; Gordon, K.E.; Hunter, K.; McGregor, F & Parkinson E (2003) Senescing oral dysplasias are not immortalized by ectopic expression of hTERT alone without other molecular changes, such as loss of INK4A and/or retinoic acid receptor-beta: but p53 mutations are not necessarily required. *Oncogene* Vol. 22, No.49 (October) pp. 7804-7808,
- Noguchi, K.; Nakajima, M.; Naito, M. & Tsuruo, T. (1995) Inhibition by differentiation-inducing agents of wild-type p53-dependent apoptosis in HL-60 cells. *Japanese Journal of Cancer Research* Vol. 86, No.2 (February) pp. 217-223.
- Ou, C.C.; Hsu, S.C.; Hsieh, Y.H.; Tsou, W.L.; Chuang, T.C.; Liu, J.Y.& Kao, M.C. (2008) Downregulation of HER2 by RIG1 involves the PI3K/Akt pathway in ovarian cancer cells. *Carcinogenesis*. Vol 28. No.2 (February) pp. 299-306
- Pasquali, D. ; Bellastella, A. ; Colantuoni, V. ; Vassallo, P. ; Bonavolonta, G. ; Rossi, V. ; Notaro, A. & Sinisi, A.A. (2003) All-trans retinoic acid- and N-(4-hydroxyphenyl-retinamide)-induced growth arrest and apoptosis in orbital fibroblasts in Graves' disease. *Metabolism* Vol. 52, No.11 (November) pp. 1387-1392,
- Randolph, R.K. & Siegenthaler, G. (1999). Vitamin A homeostasis in human epidermis; native retinoid composition and metabolism, in *Retinoids*. In: *The Biochemical and Molecular Basis of Vitamin A and Retinoid Action*, H. Nau & W.D. Blaner (Ed.) 491-520. Springer, New York, USA.
- Rogers, M.; Berestecky, J.M.; Hossain, M.Z.; Guo, H.M.; Kadle, R.; Nicholson, B.J. & Bertram, J.S. (1990) Retinoid-enhanced gap junctional communication is achieved by increased levels of connexin 43 mRNA and protein. *Molecular Carcinogenesis*, Vol 3, No.6 pp. 335-343
- Ross, S.A.; Ahrens, R.A.& De Luca, L.M. (1994) LM. Retinoic acid enhances adhesiveness, laminin and integrin beta 1 synthesis, and retinoic acid receptor expression in F9 teratocarcinoma cells. *Journal of Cellular Physiology*, Vol. 159, No.2 (May) pp. 263-273.
- Santin A.D.; Hermonat P.L.; Ravaggi, A.; Chiriva-Internati, M. Pecorelli, S. ; & Parham, G.P (1998) Retinoic acid up-regulates the expression of major histocompatibility

- complex molecules and adhesion/costimulation molecules (specifically, intercellular adhesion molecule ICAM-1) in human cervical cancer," *American Journal of Obstetrics and Gynecology*, vol. 179, No.4 (October) pp. 1020-1025,
- Shao, Z.M.; Dawson, M.I.; Li, X.S.; Rishi, A.K.; Sheikh, M.S.; Han, Q.X.; Ordonez, J.V.; Shroot, B. & Fontana, J.A. (1995) p53 independent G0/G1 arrest and apoptosis induced by a novel retinoid in human breast cancer cells. *Oncogene*, No.3 (August) Vol. 11, pp. 493-504.
- Shin, D. M.; Kim, J.; Ro, J. Y.; Hittelman, J.; Roth, J. A.; Hong, W. K., & Hittelman, W. N. (1994) Activation of p53 gene expression in premalignant lesions during head and neck tumorigenesis. *Cancer Research*, Vol. 54, No.2 (January) pp. 321-326,
- Shiraishi-Yokoyama, H.; Yokoyama, H.; Matsumoto, M., & Ishii, H. (2003) The existence of an NAD-dependent pathway for retinoic acid formation from vitamin A (retinol) in rat esophagus and its inhibition by ethanol and histamine 2 (H2) receptor antagonists. *Medical Science Monitor*, Vol. 9, No.12 (December) pp. 403-406.
- Shiraishi-Yokoyama, H.; Yokoyama, H.; Matsumoto, M.; Imaeda, H. & Hibi, T. (2006) Acetaldehyde inhibits the formation of retinoic acid from retinal in the rat esophagus. *Scandinavian Journal of Gastroenterology*, Vol.41, No.1 (January) pp. 80-86.
- Shmarakov, I.; Fleshman, M.K.; D'Ambrosio, D.N.; Piantedosi, R.; Riedl, K.M.; Schwartz, S.J.; Curley, R.W. Jr.; von Lintig, J.; Rubin, L.P.; Harrison, E.H. & Blaner W.S. (2010) Hepatic stellate cells are an important cellular site for β -carotene conversion to retinoid. *Archive of Biochemistry and Biophysics*, Vol 504, No.1 (December) pp.697-708,
- Soffritti, M.; Belpoggi, F.; Cevolani, D.; Guarino, M.; Padovani, M. & Maltoni, C. (2002) Results of long-term experimental studies on the carcinogenicity of methyl alcohol and ethyl alcohol in rats. *Annals of New York Academy of Science* vol 982, (December) pp.46-69,
- Song, S.; Lippman, S.M. ; Zou, Y. ; Ye, X. & Xu, X.C. (2005) Induction of cyclooxygenase-2 by benzo[a]pyrene diol epoxide through inhibition of retinoic acid receptor- β 2 expression. *Oncogene* Vol. 24, No.56 (December) pp. 8268-8276
- Sun, S.Y.; Yue, P.; Wu, G.S.; El Deiry, W.S.; Shroot, B.; Hong, W.K. & Lotan, R. (1999a) Implication of p53 in growth arrest and apoptosis induced by the synthetic retinoid CD437 in human lung cancer cells. *Cancer Research* Vol 59 Vol.12 (June) , pp. 2829-2833.
- Sun, S.Y.; Yue, P.; Wu, G.S.; El Deiry, W.S.; Shroot, B.; Hong, W.K. & Lotan R (1999b). Mechanisms of apoptosis induced by the synthetic retinoid CD437 in human non-small cell lung carcinoma cells. *Oncogene* Vol. 18, No.14, (April) pp. 2357-2365,
- Sun, S.Y.; Yue, P.; Shroot, B.; Hong, W.K. & Lotan, R. (1999c) Implication of c-Myc in apoptosis induced by the retinoid CD437 in human lung carcinoma cells. *Oncogene* Vol.18, No.26 (July) pp. 3894-3901
- Thomasson, H.R.; Crabb, D.W.; Edenberg, H.J. & Li, T.K. (1993) Alcohol and aldehyde dehydrogenase polymorphisms and alcoholism. *Behavior Genetics*. Vol. 23, No.2 (March) pp.131-136. 1993
- Thompson, R.H.; Allison, J.P., & Kwon, E.D. (2006) Anti-cytotoxic T lymphocyte antigen-4 (CTLA-4) immunotherapy for the treatment of prostate cancer, *Urologic Oncology*, vol. 24, No.5 (October) pp. 442-447,

- Verma A.K.; Shoemaker, A.; Simsiman, R.; Denning, M. & Zachman, R.D. (1992) Expression of retinoic acid nuclear receptors and tissue transglutaminase is altered in various tissues of rats fed a vitamin A-deficient diet. *The Journal of Nutrition* Vol. 122, No.11 (November) pp. 2144–2152,
- Vaglenova, J.; Martínez, S.E.; Porté, S.; Duester, G.; Farrés & J.; Parés, X. (2003) Expression, localization and potential physiological significance of alcohol dehydrogenase in the gastrointestinal tract. *European Journal of Biochemistry*, Vol. 270, No.12 (June) pp.2652-2662,
- Wallden, B.; Emond, M.; , Swift, M.E.; Disis, M.L. & Swisshelm, K. (2005) Antimetastatic gene expression profiles mediated by retinoic acid receptor beta 2 in MDA-MB-435 breast cancer cells. *BMC Cancer* Vol. 5, No.5 (October) pp. 140-153.
- Wan, X.; Duncan, M.D.; Nass, P. & Harmon, J.W. (2001). Synthetic retinoid CD437 induces apoptosis of esophageal squamous HET-1A cells through the caspase-3-dependent pathway. *Anticancer Research* Vol. 21, (July-August) pp. 2657-2663,
- Widschwendter, M.; Berger, J.; Daxenbichler, G.; Müller-Holzner, E.; , Widschwendter, A.; Mayr, A.; Marth, C. & Zeimet, A.G. (1997) Loss of retinoic acid receptor beta expression in breast cancer and morphologically normal adjacent tissue but not in the normal breast tissue distant from the cancer. *Cancer Research* Vol. 57, No.19, (October) pp. 4158–4161,
- Widschwendter, M.; Berger, J.; Hermann, M.; Müller, H.M.; Amberger, A.; Zeschnigk, M.; Widschwendter, A.; Abendstein, B., & Zeimet, A.G. (2000) Daxenbichler G, Marth C. Methylation and silencing of the retinoic acid receptorh2 gene in breast cancer. *Journal of the National Cancer Institute* Vol. 92, No.10 (May) pp. 826-832
- Xu, X.C.; Zile, M.H.; Lippman, S.M.; Lee, J.S.; Lee, J.J.; Hong, W.K.; Lotan, R.; Lippman, S.M.; Lee, J.S.; Lee, J.J. & Hong, W.K. (1995) Anti-retinoic acid (RA) antibody binding to human premalignant oral lesions which occurs less frequently than binding to normal tissue increases after 13-cis-RA treatment in vivo and is related to RA receptor beta expression. *Cancer Research* Vol. 55, No.23 (December) pp. 5507-5511
- Xu, X.C.; Lee, J.S.; Lee, J.J.; Morice, R.C.; Liu, X.; Lippman, S.M.; Hong W.K. & Lotan, R (1999), Nuclear retinoid acid receptor beta in bronchial epithelium of smokers before and during chemoprevention. *Journal of the National Cancer Institute* Vol 91, No.15, (August), pp.1317-1321,
- Xu, X.C. (2007) Tumor-suppressive activity of retinoic acid receptor- β in cancer *Cancer Letter* Vol. 253, No.1 (August) pp. 14-24
- Yen, A.; Roberson, M.S.; Varvayanis, S. & Lee, A.T. (1998) Retinoic acid induced mitogen-activated protein (MAP)/extracellular signal- regulated kinase (ERK) kinase-dependent MAP kinase activation needed to elicit HL-60 cell differentiation and growth arrest. *Cancer Research* Vol. 58, Bo.14 (July) pp. 3163-3172
- Yin, S.J.; Chou, F.J.; Chao, S.F.; Tsai, S.F., Liao, C.S. & Wang S.L. (1993) Alcohol and aldehyde dehydrogenases in human esophagus: comparison with the stomach enzyme activities. *Alcoholism; Clin Exp Res* Vol.17, No.2 (April) pp. 376-381
- Yin, S.J.; Chou, C.F. & Lai, C.L. (2003), Human class IV alcohol dehydrogenase: kinetic mechanism, functional roles and medical relevance. *Chemistry Biology Interaction*, Vol. 143-144, (February) pp. 219-227

- Yokoyama, A.; Muramatsu, T.; Ohmori, T.; Higuchi, S.; Hayashida, M., & Ishii H. (1996). Esophageal cancer and aldehyde dehydrogenase-2 genotype in Japanese males. *Cancer Epidemiology Biomarker Prevention* Vol. 5, No.3 (November) pp. 99-102,
- Yokoyama, A.; Tanaka, Y.; Yokoyama, T.; Mizukami, T.; Matsui, T.; Maruyama, K. & Omori, T. (2011) p53 protein accumulation, iodine-unstained lesions, and alcohol dehydrogenase-1B and aldehyde dehydrogenase-2 genotypes in Japanese alcoholic men with esophageal dysplasia. *Cancer Letter*, Vol 308, No.1 (September) pp.112-117.
- Yokoyama, H.; Baraona, E. & Lieber, C.S. (1994) Molecular cloning of human class IV alcohol dehydrogenase cDNA. *Biochemistry Biophysics Research Communication*, Vol. 203, No.1 (August) pp. 219-224,.
- Yokoyama, H.; Baraona, E. & Lieber, C.S. (1996) Molecular cloning and chromosomal localization of ADH7 gene encoding human class IV (σ) ADH. *Genomics* No.2 (January) Vol. 31, pp 243-245,
- Yokoyama, H.; Baraona, E., & Lieber, C.S. (1995a) Comparison of the ADH7 gene structure in Caucasian and Japanese subjects. *Biochemistry Biophysics Research Communication*, Vol. 212, No.3, (July), pp. 875-878,
- Yokoyama, H.; Baraona, E., & Lieber, C.S. (1995 b) Upstream structure of human ADH7 gene and the organ distribution of its expression. *Biochemistry Biophysics Research Communication*, Vol. 216, No.1 (November) pp. 216-222,
- Yokoyama, H.; Matsumoto, M.; Shiraishi, H., & Ishii, H. (2000) Simultaneous quantification of various retinoids by high performance liquid chromatography: its relevance to alcohol research. *Alcoholism Clinical Experimental Research* Vol 24, No.4 Supple (April) pp. 26S-29S.
- Yokoyama, H.; Matsumoto, M.; Shiraishi, H.; Miyagi, M.; Kato, S. & Ishii, H. (2001) NAD dependent retinoic acid formation from retinol in the human gastric mucosa : Its inhibition by ethanol, acetaldehyde, and H₂ blockers. *Alcoholism Clinical Experimental Research* Vol. 25, No.6 (June) 24S-28S,.
- Yokoyama, H.; Shiraishi-Yokoyama, H. & Hibi, T. (2010) Structural features of the NAD-dependent *in-situ* retinoic acid supply system in esophageal mucosa. *Alcoholism Clinical Experimental Research*. Vol. 34 Suppl 1, (February) pp. S39-S44.
- Yoshida, A.; Hsu, L.C. & Dave, L. (1992) Retinal oxidation activity and biological role of human cytosolic aldehyde dehydrogenase. *Enzyme* Vol 46, No.4-5, pp. 239-244.
- Yu, H.S.; Oyama, T.; Isse, T.; Kitagawa, K.; Pham, T.T.; Tanaka, M., & Kawamoto, T. (2010) Formation of acetaldehyde-derived DNA adducts due to alcohol exposure. *Chemico-Biological Interaction*. Vol. 188, No.3 (December) pp. 367-375.
- Zou, C.P. ; Clifford, J.L.; Xu, X.C.; Sacks, P.G.; Chambon, P.; Hong, WK, & Lotan, R. (1994) Modulation by retinoic acid (RA) of squamous cell differentiation, cellular RA-binding proteins, and nuclear RA receptors in human head and neck squamous carcinoma cell lines. *Cancer Res* Vol. 54, No.20 (October), pp. 5479-5487

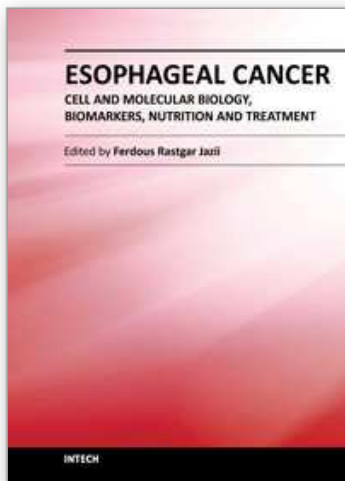

Esophageal Cancer - Cell and Molecular Biology, Biomarkers, Nutrition and Treatment

Edited by Prof. Ferdous Rastgar Jazii

ISBN 978-953-51-0223-6

Hard cover, 244 pages

Publisher InTech

Published online 07, March, 2012

Published in print edition March, 2012

Esophageal Cancer illustrates recent achievements and investigations in the esophageal tumorigenesis from different perspectives. Readers find mechanisms involved in esophageal tumorigenesis, cellular, molecular, genetic, epigenetics, and proteomics, their relevance as the novel biomarkers and application in esophageal cancer diagnosis and therapy. The book covers detailed effect of nutritional factors in addition to ethanol metabolic pathway in the inhibition of retinoic acid metabolism and supply. Diagnosis, classification, and treatment of esophageal cancer, application of both surgical and non surgical methods as well as follow up of the disease are described in detail. Moreover readers are endowed with especial features of esophageal cancer such as multiple early stage malignant melanoma and pulmonary edema induced by esophagectomy, the two features that received less attention elsewhere in literature.

How to reference

In order to correctly reference this scholarly work, feel free to copy and paste the following:

Hirokazu Yokoyama, Haruko-Shiraishi Yokoyama and Toshifumi Hibi (2012). The Interaction Between the Metabolism of Retinol and Ethanol in Esophageal Mucosa – A Possible Mechanism of Esophageal Cancer in Alcoholics, *Esophageal Cancer - Cell and Molecular Biology, Biomarkers, Nutrition and Treatment*, Prof. Ferdous Rastgar Jazii (Ed.), ISBN: 978-953-51-0223-6, InTech, Available from:
<http://www.intechopen.com/books/esophageal-cancer-cell-and-molecular-biology-biomarkers-nutrition-and-treatment/the-interaction-between-the-metabolism-of-retinol-and-ethanol-in-esophageal-mucosa-a-possible-mechan>

INTECH
open science | open minds

InTech Europe

University Campus STeP Ri
Slavka Krautzeka 83/A
51000 Rijeka, Croatia
Phone: +385 (51) 770 447
Fax: +385 (51) 686 166
www.intechopen.com

InTech China

Unit 405, Office Block, Hotel Equatorial Shanghai
No.65, Yan An Road (West), Shanghai, 200040, China
中国上海市延安西路65号上海国际贵都大饭店办公楼405单元
Phone: +86-21-62489820
Fax: +86-21-62489821

© 2012 The Author(s). Licensee IntechOpen. This is an open access article distributed under the terms of the [Creative Commons Attribution 3.0 License](#), which permits unrestricted use, distribution, and reproduction in any medium, provided the original work is properly cited.

IntechOpen

IntechOpen