

We are IntechOpen, the world's leading publisher of Open Access books Built by scientists, for scientists

4,500

Open access books available

118,000

International authors and editors

130M

Downloads

Our authors are among the

154

Countries delivered to

TOP 1%

most cited scientists

12.2%

Contributors from top 500 universities



WEB OF SCIENCE™

Selection of our books indexed in the Book Citation Index
in Web of Science™ Core Collection (BKCI)

Interested in publishing with us?
Contact book.department@intechopen.com

Numbers displayed above are based on latest data collected.
For more information visit www.intechopen.com



Mouse Models for Atopic Dermatitis Developed in Japan

Hiromichi Yonekawa¹, Toyoyuki Takada², Hiroshi Shitara¹, Choji Taya¹,
Yoshibumi Matsushima³, Kunie Matsuoka⁴ and Yoshiaki Kikkawa⁴

¹Center for Basic Technology Research

Tokyo Metropolitan Institute of Medical Science, Tokyo

²Mammalian Genetics Laboratory, National Institute of Genetics, Mishima

³Research Institute for Clinical Oncology, Saitama Cancer Center, Saitama

⁴Mammalian Genetics Project, Tokyo Metropolitan Institute of Medical Science, Tokyo
Japan

1. Introduction

The term atopic dermatitis (AD) was first proposed by Wise & Sulzberger (Wise, 1993), who defined the condition as “confusing types of localized and generalized lichenification, generalized neurodermatitis or a manifestation of atopy.” AD (or atopic eczema) is recognized as a very common disease that affects at least 15% of children and is strongly associated with cutaneous hyper-reactivity to environmental triggers (Geha, 2003, Leung and Bieber, 2003, Novak et al., 2003). AD is characterized by complex symptoms, including chronic relapsing, extreme pruritus and eczematous skin disease, all of which are frequently associated with IgE hyperresponsiveness to environmental allergens (Hanifin, 1980, Larsen et al., 1986, Schultz Larsen, 1993). The rapid increase in the prevalence of AD over the past three decades has resulted in an intense effort to elucidate the underlying pathogenesis and in the use of radical treatments for this disorder (Taylor et al., 1984, Larsen et al., 1986, Geha, 2003). The causative factors for AD generally fall into two categories: environmental and genetic factors. House dust mites and air pollution are included in the environmental category, and their involvement in the disease has been strongly suggested by epidemiological studies (Hanifin, 1982). Alternatively, genetic factors, including several different candidate regions, have been suggested from linkage studies on atopic and non-atopic phenotypes see Morar et al., (2006) and references therein). The fact that multiple linkage regions have been associated with the disease might be due to: 1) the disease is polygenic and many different genetic factors may be affected with the diseases, 2) the disease is clinically heterogeneous and different subphenotypes are influenced by different risk loci, which is not always followed by one-to-one correspondence, 3) different populations have a different genetic pool and may have different genetic factors for the disease, and consequently genetic studies are still not good enough to correspond to these situations. Additionally, there is a lack of appropriate animal models for human AD except for the flaky tail (*Flg^{fl}*) mouse. The *Flg^{fl}* mouse carries a loss-of-function (LOF) mutation in the gene encoding filaggrin (FLG), and this LOF mutation causes the barrier abnormality.

The barrier abnormality is recently discovered to be linked to the incidence of AD (Oyoshi et al., 2009, Vercelli, 2009, Moniaga et al., 2010, O'Regan and Irvine, 2010).

2. Mouse models for human AD

To date, at least four mouse models for human AD have been developed in Japan. Two of four models, NC (NC/Nga) and NOA, are controlled by multiple genes, whereas the other two, *DS-Hm* and *KOR-adjm*, are controlled by a single gene. No responsible genes have been isolated yet from the polygenic AD models, even though the genetic loci were identified a decade ago. In contrast, the responsible genes for the monogenic AD models have been identified. Interestingly, the functions of the respective genes are completely different; one is a thermosensor in keratinocytes, whereas the other is an adapter protein in the NF- κ B signaling pathway.

2.1 Polygenic mouse models for human AD: NC and NOA

Two promising mouse models for human AD are the inbred strains named Nishiki Nezumi Cinnamon (NC) (Matsuda et al., 1997) and Naruto Research Institute Otsuka Atrichia (NOA) (Natori et al., 1999). The NC strain was originally established in 1957 by Prof. K. Kondo of Nagoya University from a stock derived from Japanese fancy mice, called Nishiki Nezumi (Kondo et al., 1969, Kondo, 1983, Festing, 1996). The NC mice spontaneously develop severe dermatitis in the presence of nonspecific allergens. Morbid NC mice exhibit AD symptoms, including itching, erythema, hemorrhage, edema, crust, drying, and excoriation/erosion hyperplasia of the epidermis region of the face, neck, and/or back, and the symptoms are exacerbated by aging (Matsuda et al., 1997). Furthermore, NC mice display some of the characteristic histopathological features of AD, such as macrophage and eosinophil invasion into the dermis, increased numbers and activation of mast cells and lymphocytes, a reduction in ceramide (Aioi et al., 2001), the appearance of activated mast cells, and CD4⁺ T cells in the lesion. These lines of evidence suggest that the symptoms shown by NC mice are quite similar to those of human AD from the clinical, pathological, and immunological perspective.

As an alternative to the NC model, the NOA strain was derived from a male spontaneous mutant with sparse coat hair, which was obtained in 1982 by cross breeding between a female C3H/He mouse and a male ddY mouse at the animal facility of Naruto Research Institute, Otsuka Pharmaceutical Factory, Inc. and was then established as an inbred strain. The visible characteristic phenotype of the NOA mouse is that the mouse becomes completely hairless and smooth-skinned in adulthood until the development of skin lesions. In particular, ulcerative skin lesions are observed with a prevalence of 30% by the 10th week of age and 90% by the 20th week of age. In severe cases, the lesions extend to cover almost 20% of surface area of the body. In addition, serological examination showed increased IgE levels, with significantly higher levels in the mice with ulcerative skin lesions, suggesting that IgE is also involved in the development of the lesions (Kondo et al., 1997). The susceptibility of NOA mice to AD is increased by *S. aureus* colonization of the skin, suggesting that the NOA model is a potentially useful animal model for evaluating the effects of antiseptic treatments on the disease (Kondo et al., 2006). NOA mice have also been subjected to therapy by Chinese herbal medicine (Lee et al., 2006) to survey factors associated with AD (Watanabe et al., 1999).

2.2 Details of the NC model

Of the two models, the NC model has been more widely used to compare the phenotype between human AD patients and the mice, to explore causative genes (Ito et al., 2004, Ogawa et al., 2005, Fallon et al., 2009, Jung et al., 2011) and genetic loci (Kohara et al., 2001), and for drug development (Yamamoto et al., 2007, Shah et al., 2010, Tanaka and Matsuda, 2011) and the therapy of human AD (Takeda and Gelfand, 2009). Therefore, the immunological, pathological and genetic characteristics have been extensively examined in detail.

To perform preclinical trials or to survey potential drug targets for AD using mice, a high incidence of AD onset is required. Thus, there is a drawback to using NC mice, namely, that the NC mice exhibit a very low rate of the spontaneous onset of AD under specific pathogen-free (SPF) conditions. Even under conventional (non-SPF) conditions, the incidence rates of AD are variable and depend on the circumstances of the animal facility in which the NC mice have been bred (Kikkawa et al., unpublished results). Therefore, experimental conditions for the onset of AD are necessary for a high and stable incidence of AD. Although hypersensitivity to some environmental factors is suggested to cause dermatitis, the precise factor remains unclear. The breakthrough identification of conditions to induce AD in NC mice was made by Morita and colleagues, who discovered that fur mites induced dermatitis associated with IgE hyperproduction in a substrain of mice, NC/Kuj (Morita et al., 1999), and the mite antigen-induced dermatitis was subsequently confirmed (Sasakawa et al., 2001). These lines of evidence suggested a new model system for antigen-induced dermatitis. Alternatively, dermatitis can also be induced in NC mice by a hapten, such as 2,4-dinitrofluorobenzene (DNFB) (Tomimori et al., 2002, Tomimori et al., 2005), trinitrochlorobenzene (TNCB) (Taniguchi et al., 2003), or FITC (Hvid et al., 2009). Using these induced dermatitis models in NC mice, extensive surveys for therapeutic agents, both chemicals and herbal medicine, have been performed (Kobayashi et al., 2003, Lee et al., 2007, Jiang et al., 2009, Joo et al., 2009, Lee et al., 2010, Choi et al., 2011, Kim et al., 2011, Park et al., 2011, Sung et al., 2011a, Sung et al., 2011b, Wu et al., 2011).

2.3 Establishment of hairless NC mice for the development of drugs and comprehensive therapy for human AD

Although the NC model is a promising mouse model for AD, it has another serious drawback, namely the existence of dense hair on the body. The dense hair disturbs the pathological observation of the symptoms in the earlier stages of AD onset and without hair shaving also interferes with the painting of an ointment to test its efficacy. Hair shaving itself leads to another severe problem, laboratory animal allergy (LAA). LAA is a form of occupational allergic disease. The development of LAA is due to the presence of IgE antibodies directed against animal proteins, and incidence rates are rapidly increasing. Hair shaving increases the chance of direct exposure of the researcher to the animal proteins, and the worst possible outcome of LAA is death by anaphylactic shock (Pacheco et al., 2003, Schweitzer et al., 2003, Matsui et al., 2004, Curtin-Brosnan et al., 2010). Therefore, a hairless model on an AD-prone genetic background would be an ideal and powerful tool for basic research, such as the discovery of the genes responsible for AD, and for drug development, such as the development of new ointment for the treatment of AD.

We have generated a hairless mouse model for AD on the NC genetic background to study the pathophysiology of the disease and to screen ointment compounds as novel therapies for skin lesions. To generate the hairless mice, we applied a novel method that we recently developed for the ablation of specific cell lineages using diphtheria toxin (DT), also known

as the TRECK (Toxin receptor mediated cell knockout) method (Saito et al, 2001). To achieve the specific ablation of hair shafts, we used the promoter of the keratin 71 (*Krt71*/formerly *krt2-6g* or *mK6irs1*) gene, which encodes a type 2 keratin filament protein. The *Krt71* gene is involved in hair development, and mutation of the gene affects the morphology of the coat hair because the gene product is expressed in the cells of the inner root sheath (IRS). Several allelic mutations found in the Caracul (*Ca*) phenotype are morphologically very similar to the classic wavy coat mutation in laboratory mice (Kikkawa et al., 2003). Therefore, we constructed a minigene in which the expression of the human DT receptor, the intrinsic mechanism of which is to bind the heparin-binding EGF (Naglich et al., 1992a, Naglich et al., 1992b), is driven by the promoter of the *Krt71* gene (Fig. 1A). The minigene was introduced directly into pronucleus-stage eggs of the NC strain to generate 'NC/Nga-*Krt71*-TRECK'-transgenic (Tg) mice. Unexpectedly, NCN24, one of the two NC Tg founder lines, exhibited a dominant hairless phenotype without the administration of DT (Fig. 1B). Furthermore, a predisposition to atopic dermatitis-like symptoms and the elevation of IgE levels were observed in both the NCN24 and the wild type NC strain (Fig. 2). Our newly developed NCN24 mice will be useful to assess drugs for AD therapy because they allow the monitoring of skin inflammation without shaving (Takada et al., 2008b). DT is highly

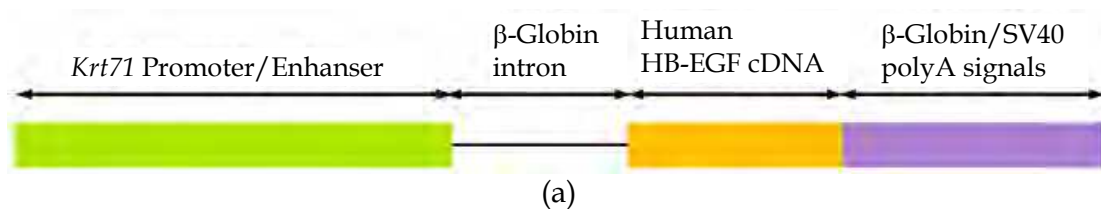

(a) Approximately 9 kb of the *Krt71* promoter region was amplified by PCR using genomic C57BL/6J mouse DNA. The *Krt71* promoter was cloned into the *Bam*HI and *Not*I sites of the TRECK vector (Saito et al. 2001). The 11-kb *Not*I/*Xho*I fragment containing the *Krt71* promoter, the β -globin intron, and human HB-EGF cDNA was excised, purified and used for microinjection.

(b) NC/Nga-Tg(*Krt71*-HBEGF)24Rin (NCN24) mice at postnatal day 14 (P14) exhibit a hairless phenotype over the whole body without DT treatment compared with the wild type littermates.

Fig. 1. Generation of *Krt71* promoter/human HB-EGF transgenic NC mice

toxic to humans, and therefore, it is not an appropriate agent to use in experimental models intended to investigate the pathogenic aspects relevant to human disease. DT treatment and the attention required for DT administration in mice would no longer be needed if the novel hairless Tg mice were used.

The NCN24 strain is co-isogenic to the wild type NC strain because the minigene was directly introduced into the NC genome by microinjection as described earlier. This means that, with the exception of coat hair, no phenotypic differences are expected between NCN24 mice and the original NC mice. We confirmed this by comparing the coat hair, the time to AD onset, the progression of AD, the serum IgE level and its change over time, and the composition of the immune cell populations in the bone marrow, spleen and thymus (Table 1) between NCN24 mice and the original NC mice (Takada et al., 2008b). As expected, there were no differences between the two strains except for coat hair. Therefore, we conclude that NCN24 mice will be useful for assessing the efficacy of drugs and for developing AD therapy because the model enables researchers to monitor skin inflammation without shaving.

A remaining issue is why the hairless phenotype occurred in the NCN24 line without the administration of DT because the TRECK method upon which the model was designed is based on the aberration of a cell lineage by DT through the human DT receptor (DTR) driven by a tissue-specific promoter introduced into the transgenic minigene (Saito et al, 2001). The key evidence for this phenomenon, namely, hairless phenotype without DT administration is that the original cellular function of DTR is heparin-binding EGF, an important role of which is the molecular regulation of the hair cell cycle (Mak and Chan, 2003). From the P1 to P12 stages in the NCN24 mice, we only observed immature or irregular hair follicles distributed in the skin sections, indicating that the proper processes

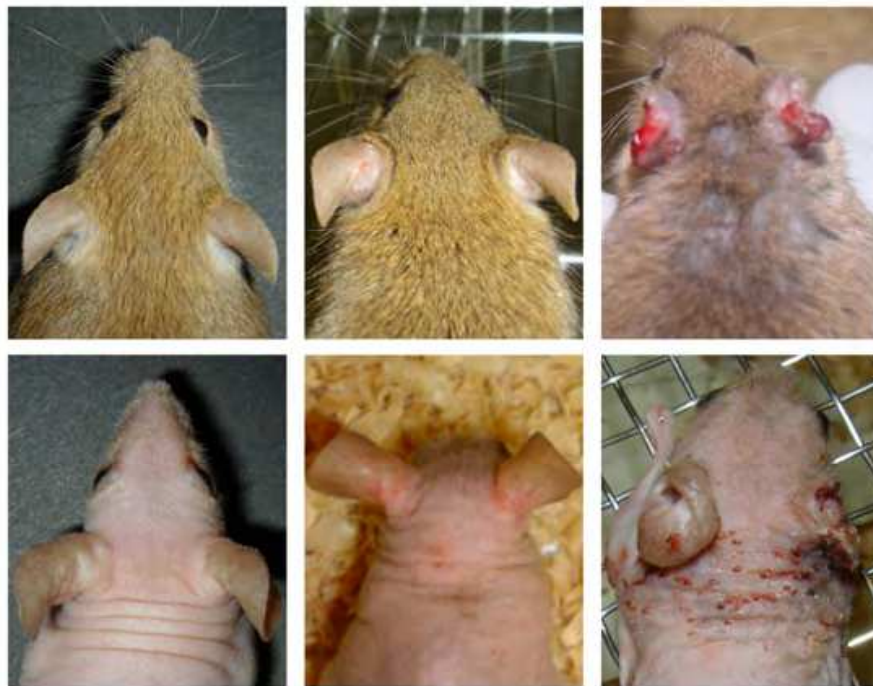

Fig. 2. The severity and histological features of the atopic dermatitis-like skin lesions in wild type (upper row) and NCN24 (lower row) mice during the progression of AD. The atopic dermatitis-like skin lesions were observed in the pinnae and scapula of the dorsal area along with congestion and scaly symptoms, and advanced dermatitis was seen in the middle- and right-side photographs in both wild type NC/Nga (upper low) and NCN24 mice (lower low).

Immune cells	Bone Marrow ($\times 10^6$)		Spleen ($\times 10^6$)		Thymus ($\times 10^6$)	
	WT	NCN24	WT	NCN24	WT	NCN24
Total cell number	33.00	34.80	56.40	63.10	84.60	98.55
B lineage cells	8.28	9.12	27.25	21.09	-	-
Dendritic cells	-	-	0.60	0.48	-	-
Myeloid cells	10.24	11.38	2.98	2.10	-	-
NK cells	0.14	0.09	1.40	1.16	-	-
NKT cells	0.07	0.05	0.27	0.22	-	-
T lineage cells	0.28	0.12	9.25	6.19	10.58	10.67
CD4 ⁺ cells	-	-	7.20	4.56	6.23	5.72
CD8 ⁺ cells	-	-	2.36	1.57	1.93	2.22
CD4 ⁺ CD8 ⁺ cells	-	-	-	-	75.35	89.58
CD4 ⁺ CD25 ⁺ cells	-	-	0.27	0.27	0.46	0.37

B lineage cells (CD19⁺), Dendritic cells (CD11c⁺), Myeloid cells (Gr-1⁺), NK cells (NK1.1⁺DX5⁺), NKT cells (NK1.1⁺CD3⁺), T lineage cells (CD3⁺). Data shown are the mean from two littermates.

Table 1. The number of immune cells in wild-type (wt) and NCN24 mice.

were not occurring in the first hair cycles, with congestion and scaly symptoms, and advanced dermatitis was seen in both wild type and NCN24. starting from the early anagen phase. The mechanisms that potentially cause the hairless phenotype could be simple; specifically, it could be the ectopic expression of the DTR (HB-EGF) driven by the *Krt71* promoter in the inner root sheath (IRS). As described earlier, HB-EGF is the major molecular regulator for the hair cell cycle (Mak and Chan, 2003). Transgenic mice in which HB-EGF was overexpressed by a ubiquitous expression vector showed hair abnormalities, including a bare-patch phenotype. This phenotype was attributed to the ectopic and irregular overexpression of HB-EGF in the IRS of the Tg mice (Takada et al., 2008b). Similarly, a spontaneous mutation at the *Krt71* locus also caused a bare-patch phenotype (Poirier et al., 2002). Therefore, the most likely mechanism causing the hairless phenotype in our Tg mice is the ectopic overexpression of HB-EGF, which disturbs the initiation of the normal hair cell cycle. Specifically, the *Krt71* promoter in the transgene guaranteed the IRS-specific expression of HB-EGF, which augmented the ectopic expression of HB-EGF in the IRS. Several mechanisms have previously been reported in which molecular signaling via the ErbB family, the members of which are involved downstream of HB-EGF signaling, is critical for skin and hair development during the neonatal period. HB-EGF is an essential molecule for the initiation of hair growth and for entry into the appropriate phase of the hair cycle (Mak & Chan 2003), although it is not clear how the human HB-EGF transcript might affect the development of the hair follicles in the neonatal period of NCN24 mice.

Evidence of an alternative explanation is that the phenotype we described partially resembles several phenotypic features that were reported in studies of the hairless mouse harboring a *hr/hr* mutation (Brooke, 1926). The hairless (*hr*) mutant mice have been well characterized and exhibit a hairless phenotype due to a failure of the follicular papilla to

ascend to the permanent portion of the hair follicle during the first catagen phase (Panteleyev et al., 1999). Therefore, we considered that a functional defect in the follicular papilla early in the anagen phase of NCN24 mice could cause an irregular sorting of the melanin granules and the weak and degraded features of the hair shaft. Unlike in the *hr* phenotype mice, hair degradation was observed in the newborn animals of the NCN24 line, demonstrating that in these hairless mice, the development of the hair follicles progressed normally, while the first cycle of the anagen phase was impaired (Takada et al., 2008b).

A third possibility is that the insertion disrupted a gene (s) that is indispensable for hair development. However, this is very unlikely because fluorescence in situ hybridization (FISH) analysis revealed that the transgene was detected in the telomeric region of chromosome 14, where no indispensable genes have been reported thus far (Takada et al., 2008b).

2.4 Attempts to identify the genes responsible for AD using polygenic AD models

Linkage analyses and a quantitative traits loci (QTL) analysis have been performed for the two models for human AD, NC and NOA, to identify the genetic loci responsible for AD. Using intercrossing or backcrossing between an AD model and a non-AD counterpart, the segregation ratio of F₂ or N₂ progeny was examined, and it was discovered that the segregation ratios did not follow Mendelian inheritance, suggesting that the AD phenotype is controlled by multiple genes. In fact, several loci were identified in both NC and NOA, as discussed below (Natori et al., 1999, Kohara et al., 2001, Watanabe et al., 2001). Despite extensive attempts spanning a decade, no responsible genes have yet been identified by positional cloning.

2.4.1 Linkage analyses for AD in NOA

Detailed linkage analyses revealed a significant co-segregation between ulcerative skin lesions and markers on murine chromosome 14. A statistical analysis indicated that the critical region was in the vicinity of *D14Mit236* and *D14Mit160* (Natori et al., 1999). These analyses also identified two additional modifier genes: one in the middle of chromosome 7 and the other in the telomeric region of chromosome 13 (Watanabe et al., 2001).

2.4.2 Linkage analyses for AD in NC

We performed a linkage disequilibrium analysis between AD or hyper-IgE-emia and chromosome-specific microsatellite loci in the backcrossed progeny of NC and MSM/Ms (MSM) mice. The MSM line originated from Japanese wild mice, *Mus musculus molossinus* (Moriwaki et al., 2009), and maintains a very large amount of genetic diversity in the genome (Kikkawa et al., 2001, Sakai et al., 2005, Takada et al., 2008a) compared with other classical inbred strains, such as BALB/c and C57BL/6, and we often use the MSM strain to perform finer genetic mapping. This analysis led to two important observations: 1) the occurrence of dermatitis is not associated with an elevated serum IgE level (Kohara et al. unpublished); and 2) the major locus responsible for dermatitis (the *derm1* locus) is located on the middle of chromosome 9 (Fig. 3). We also discovered additive (potentially modifier) loci with suggestive level on a few chromosomes (Kikkawa et al., unpublished). This genetic status resembles that of human AD because human AD is also polygenic, and mono- or oligogenic AD has not yet been reported. Furthermore, the association between hyper-IgE-emia and dermatitis/eczema is not always observed in humans. Unfortunately, we have not found any significant or suggestive loci for hyper-IgE-emia.

2.5 Monogenic mouse models for human AD: DS-*Nh* and KOR-*adjm*

In contrast to the polygenic AD models, there are two models in Japan that are the result of a single mutation. One is DS-*Nh*, and the other is KOR-*adjm*. Unlike the mouse models with polygenic factors, the genes responsible for dermatitis, DS-*Nh* and KOR-*adjm*, have been identified from the monogenic AD models.

2.5.1 The DS-*Nh* gene is the transient receptor potential cation channel, subfamily V member 3 (TRPV3)

A spontaneous mutant strain with a hairless phenotype (DS-*Nh*) was isolated from an inbred strain, DS, which was developed in 1954 from an outbred dd stock of the Central Institute for Experimental Animals, Tokyo, Japan. The DS-*Nh* mice exhibit ulcerative skin lesions on the cheek, neck and shoulder as initial symptoms when the mice are transferred from SPF to conventional conditions. The skin lesions have been associated with hyper-IgE-emia triggered by *Staphylococcus aureus* infection (Watanabe et al., 2003a, Watanabe et al., 2003b). The DS-*Nh* mice also exhibit heavy scratching behavior to itching, which is associated with elevated levels of histamine and nerve growth factor in the serum and/or skin tissues (Yoshioka et al., 2006). Furthermore, the DS-*Nh* mice exhibit other features that resemble human AD, such as significantly increased serum levels of IL-4 and IL-13 (Hikita et al., 2002) and increased numbers of whole mast cells and CD4⁺ T cells (Yoshioka et al., 2006). Therefore, the DS-*Nh* mouse is a model of the pruritus associated with human AD.

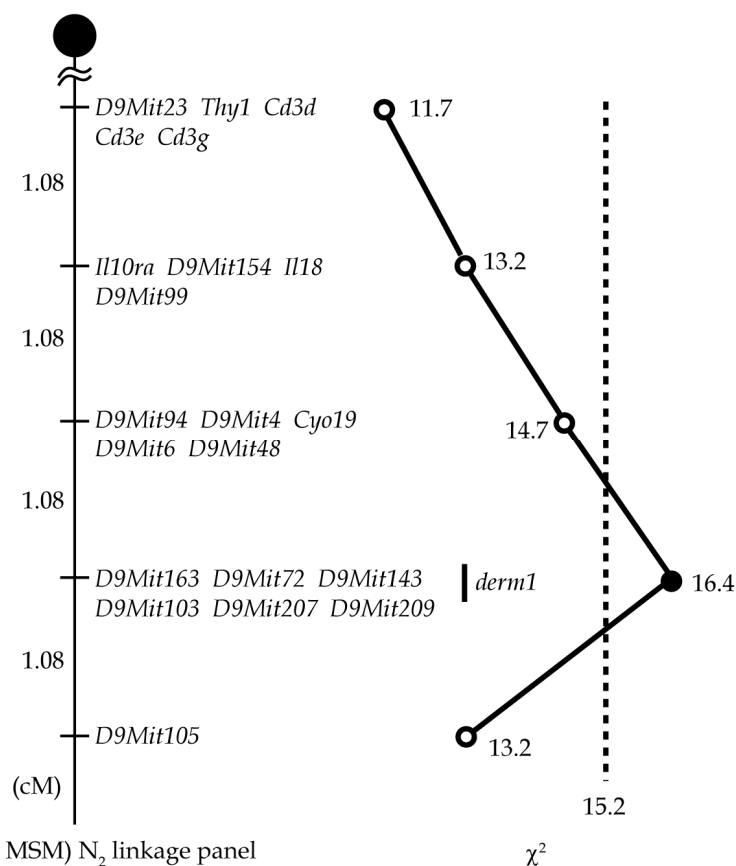
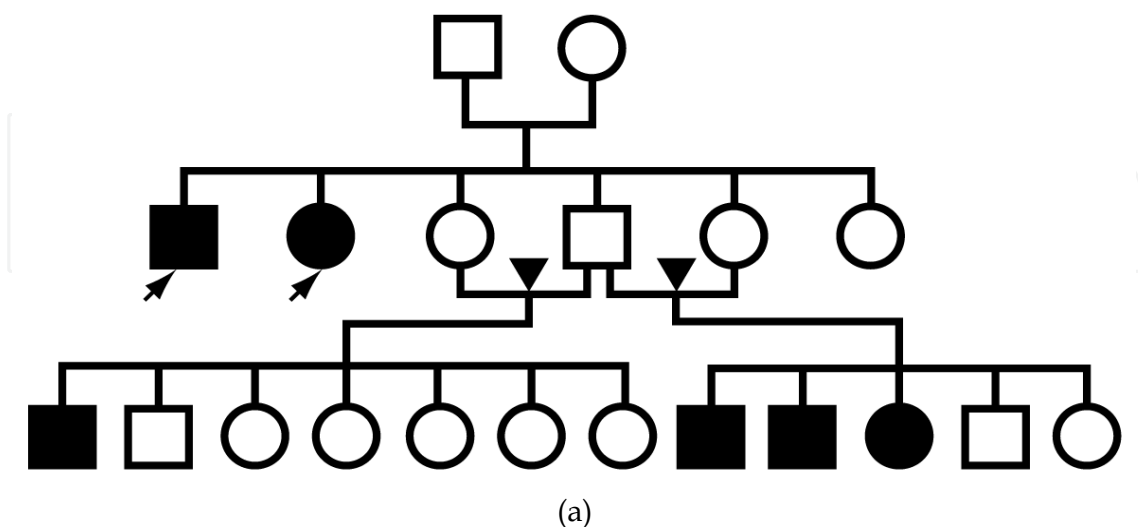

Fig. 3. Using (NC x MSM) N₂ mice, a linkage disequilibrium analysis was performed, and a single significant genetic locus responsible for AD was identified on chromosome 9. We designated the locus *derm1*.

The *Nh* mutation is controlled by a single dominant mutation that occurred in the transient receptor potential (TRP) cation channel, subfamily V member 3 (*Trpv3*). The TRP channels are expressed ubiquitously in the body and are thought to have important roles in maintaining proper vital status (Okuhara et al., 2007) because they are critical mediators in sensory systems and respond to temperature, touch, pain and other important stimuli. TRP channels are divided into six main subfamilies, including TRPV (Clapham, 2003). The TRPV subfamily is expressed in the skin, keratinocytes and hair follicles and is activated by temperatures higher than 32-39°C (Peier et al., 2002). The Gly573Ser substitution of *Trpv3* leads to increased ion-channel activity in keratinocytes, which influences the hair growth cycle in mice (Imura et al., 2007). By studying dermatitis in DS-*Nh* mice, two major pathways have been identified; one is the interaction between the gain-of-function *Trpv3* mutation and NKT cells with the T-cell receptor V β , and the other is the synergistic production of interleukin-13 (IL-13) through the activation of Toll-like receptor 2 by staphylococcal enterotoxin C-producing *S. aureus* (Yoshioka et al., 2007, Imura et al., 2008, Imura et al., 2009, Yoshioka et al., 2009).

2.5.2 The KOR-*adjm* gene is TNFR-associated factor 3-interacting protein 2 (TRAF3IP2)

Recently, we identified a new mouse model for human atopic dermatitis, the phenotype of which is controlled by a single recessive mutation. The spontaneous mutant mice, which exhibited high levels of serum IgE and an atopic dermatitis (AD)-like skin disease, were identified from a colony of the KOR inbred strain, which was derived from Japanese wild mice (Figs. 4, 5). No segregation was observed between hyper-IgE-emia and dermatitis in BALB/c x KOR mutant N₂ mice. Furthermore, linkage analysis showed that both phenotypes are controlled by a same single recessive locus, and thus we designated the



(a) Phenotype segregation in the KOR colony. A pedigree of the KOR strain in which *adjm* mutant mice were first discovered (shown by arrows). The squares and circles represent males and females, respectively. The closed and open symbols represent affected and non-affected individuals, respectively.

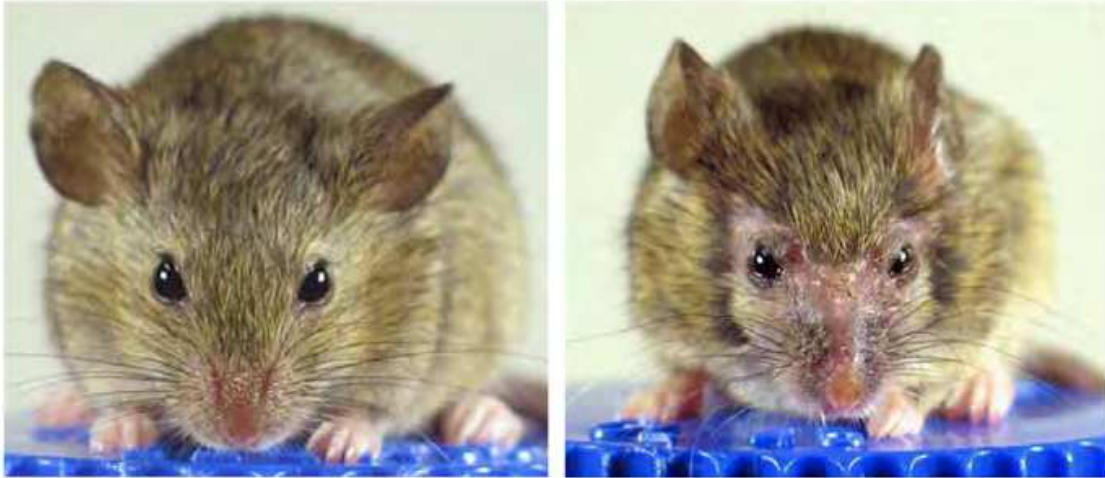

(b)

(b) The appearance of a healthy (left) *KOR-adjm/adjm* mouse after *KOR-adjm/+* mouse disease onset is shown (right).

Fig. 4. *adjm* mutation identified from the KOR mouse colony.

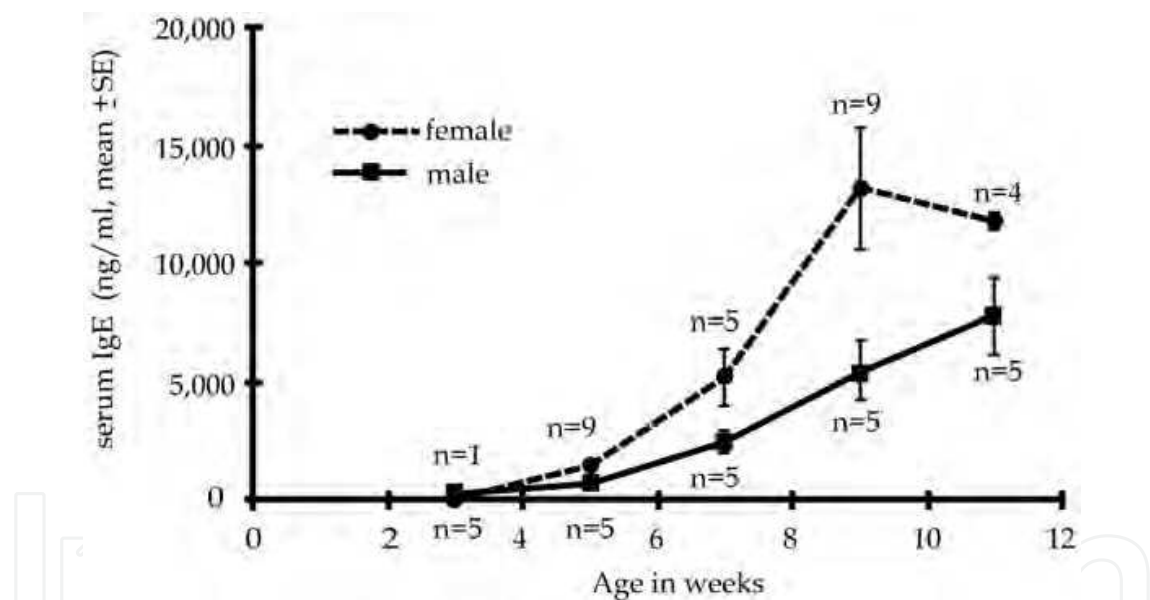

Fig. 5. Age-dependent increase in serum IgE level. The increase began at 5 weeks of age, and the IgE level reached 13,104 ng/ml by the age of 11 weeks. The IgE levels in female mutant (*KOR-adjm/adjm*) mice were twice as high as those in male mice

locus as *adjm* (atopic dermatitis from Japanese mice). We isolated the gene responsible for the AD-like phenotypes by positional cloning and discovered that the gene is the mouse homologue of the human TNFR-associated factor 3-interacting protein 2 (TRAF3IP2), which has formerly been called ACT1 (Li et al., 2000) or CIKS (Leonardi et al., 2000) protein. Furthermore, the gene included a single point mutation leading to the substitution of a stop codon for glutamine at amino acid position 214 (Fig. 6) (Matsushima et al., 2010). TRAF3IP2 was first reported as an adaptor protein that is associated with and activates IB kinase and stimulates both the NF- κ B and the JNK signaling pathways (Li, 2008). It has been shown to

function as an adaptor protein in signaling pathways mediated by the TNFR superfamily members CD40 and B cell-activating factor in epithelial cells and B cells as well as in the IL-17-mediated signaling pathway (Li et al., 2000). Our results suggest that dysfunction of the TRAF3IP2 protein causes hyper-IgE-emia through the CD40- and B cell-activating factor-mediated pathway in B cells and causes skin inflammation through the IL-17-mediated pathway. This study demonstrates that the TRAF3IP2 protein has an important role in AD and suggests that the protein could be a therapeutic target for the treatment of AD (see Matsushima et al. (2010) and references therein).

Mouse	M-----	NRSIPVEVDE	SEPFPSQLLK	PIPEYSFEEE	LEPPAPNTRN	MAPSSLS---	VLQCPP----	-----LKLAN
Human	MPPQLQETRM	NRSIPVEVDE	SEPYPSQLLK	PIPEYSFEEE	SEPPAPNIRN	MAPNSLSAPT	MLHNSSGDFS	QAHSTLKLAN
Mouse	HQ-PVSQQVT	CLRAKVEEG	EASFFRRHPE	LGKDISSCSS	GASEPESE--	LGALPPEHRF	TLTEKRRRWL	GSQLSAASPD
Human	HQRPVSRQVT	CLRTQVLEDS	EDSFCCRHPG	LGKAFPSGCS	AVSEPASESV	VGALPAEHOF	SFMEKRNOWL	VSQLSAASPD
Mouse	TGHESDKSDP	SLPNALADSF	SGGQEMMPRP	RPRPGPHRRR	AAPDVPTIDT	GYDSQPQDVL	GIRQLERPLP	LTSSCYLQDL
Human	TGHDSDKSDQ	SLPNASADSL	GGSQEMVQRP	QF----HRNR	AGLDLPTIDT	GYDSQPQDVL	GIRQLERPLP	LTSVCYPQDL
Mouse	PGPLRSREL	PQFELERYPM	NAQLLPPHPS	PQAPWNCQYY	CPGGPYHHQV	PHGHGYPPAA	AYQOVLQPAL	PGQVLPGARA
Human	PRPLRSREFF	-QFEPQRYPA	CAQMLPPNLS	PHAPWNYHYH	CPGSP-DHQV	PYGHDYPRAA	-YQQVIQPAL	PGQPLPGASV
Mouse	RGPRPVQKVI	LNDSSPQDQE	ERPAQRDFS	PRLPR--DQL	YRPFSNGVEA	PEESLDLPAE	LRPHGQAPS	LAAVRPSPSN
Human	RGLPVQKVI	LNYPSPWDHE	ERPAQRDCSF	PGLPRHQDQP	HHQPPNRAGA	PGESLECPAE	LRPQVPQPPS	PAAVRPSPSN
Mouse	PLARGTLRTS	NLPEELRKVF	ITYSMDTAME	VVKFVNFLLV	NGFQTAIDIF	EDRIRIGIDII	KWMERYLRDK	TVMIIVAIISP
Human	PPARGTLRTS	NLPEELRKVF	ITYSMDTAME	VVKFVNFLLV	NGFQTAIDIF	EDRIRIGIDII	KWMERYLRDK	TVMIIVAIISP
Mouse	KYKQDVEGAE	SQLEDEHGL	HTKYIHRMMQ	IEFISQSGSMN	FRFIPVLFPN	AKKEHVPTWL	QNTHVYSWPK	NKKNILLRLL
Human	KYKQDVEGAE	SQLEDEHGL	HTKYIHRMMQ	IEFIKQSGSMN	FRFIPVLFPN	AKKEHVPTWL	QNTHVYSWPK	NKKNILLRLL
Mouse	REEEYVAPPR	GPLPTLQVVP	L					
Human	REEEYVAPPR	GPLPTLQVVP	L					

(a)

(a) Comparison of the mouse and human TRAF3IP2 protein sequences. The amino acid sequences in open boxes or underlined with broken or solid lines are the TRAF binding sites, the helix-loop-helix domain, and the coiled-coil domain, respectively.

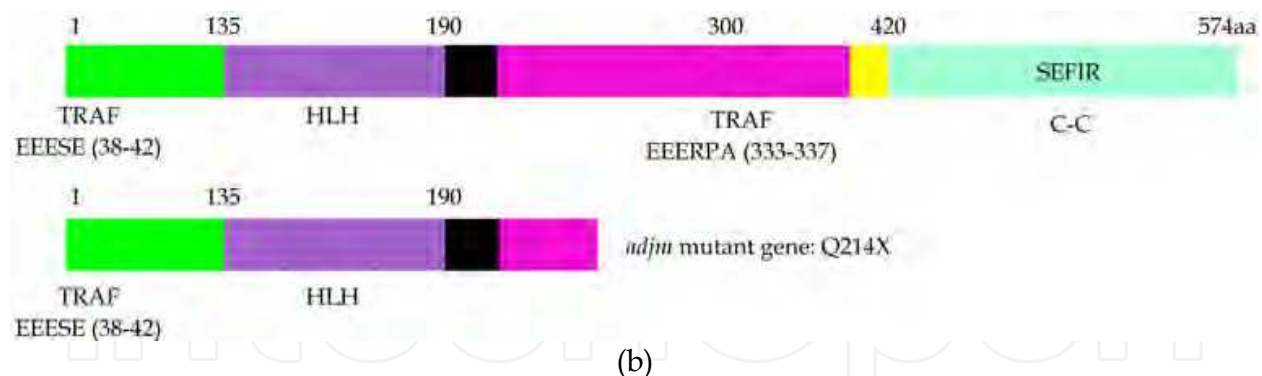

(b)

(b) The domain structure of the TRAF3IP2 protein. The *adjm* mutation causes the truncation of the TRAF3IP2 protein at amino acid 214. The truncated form lacks a C-terminal TRAF-binding site and a C-terminal coiled-coil domain.

Fig. 6. Alignment of amino acid sequence between mouse and human of TRAF3IP2 protein and the predicted structure of TRAF3IP2 protein in wild-type and *adjm* mutant

3. Conclusion

Four promising mouse models for human AD have been established thus far in Japan. Two models are polygenic, and the pathology and the onset of the disease are very similar to

human AD, although no responsible genes have been isolated. In contrast, the other two models are monogenic, and the responsible genes have been identified. One, *DS-Nh*, is a gain-of-function mutation in the *Trpv3* locus, whereas the other, *KOR-adjm*, is a loss-of-function mutation in the *Traf3ip2* locus. The former mutation demonstrated the strong involvement of IL-13 in association with the *Trpv3* locus and the TCRV β^b (NKT cell) haplotype. The latter mutation demonstrated the involvement of CD40L/BAFF signaling for B cell activation and of the IL-17 signaling pathway for the autoimmune and inflammatory responses through the activation of NF- κ B. The involvement of the NF- κ B pathway to AD is commonly suggested in both human and mouse, and therefore the finding shown here will facilitate the development of therapies and drugs.

4. Acknowledgments

This work was partly supported by grants from the Ministry of Education, Science, Technology, Sports and Culture of Japan Science (to H.Y and Y.M) and a Takeda Foundation research grant (to H.Y.).

5. References

- Aioi, A., Tonogaito, H., Suto, H., Hamada, K., Ra, C.R., Ogawa, H., Maibach, H. & Matsuda H. (2001). Impairment of skin barrier function in NC/Nga Tnd mice as a possible model for atopic dermatitis. *The British Journal of Dermatology*, Vol.144, No.1, (January 2001), pp. 12-18, ISSN 0007-0963
- Brooke, H.C. (1926). Hairless mice. *Journal of Heredity*, Vol.17, p. 173, ISSN 0022-1503
- Choi, S.E., Park, K.H., Jeong, M.S., Kim, H.H., Lee do, I., Joo, S.S., Lee, C.S., Bang, H., Choi, Y.W., Lee, M.K., Seo, S.J. & Lee, M.W. (2011) Effect of *Alnus japonica* extract on a model of atopic dermatitis in NC/Nga mice. *Journal of Ethnopharmacology*, Vol. 136, No. 3 (July 2011), pp.406-413, ISSN 0378-8741
- Clapham, D.E. (2003). TRP channels as cellular sensors. *Nature*, Vol.426, No.6966, (December 2003), pp. 517-524, ISSN 0028-0836
- Curtin-Brosnan, J., Paigen, B., Hagberg, K.A., Langley, S., O'Neil, E.A., Krevans, M., Eggleston, P.A. & Matsui, E.C. (2010). Occupational mouse allergen exposure among non-mouse handlers. *Journal of Occupational & Environmental Hygiene*, Vol.7, No.12, (December 2010), pp. 726-734, ISSN 1545-9624
- Fallon, P.G., Sasaki, T., Sandilands, A., Campbell, L.E., Saunders, S.P., Mangan, N.E., Callanan, J.J., Kawasaki, H., Shiohama, A., Kubo, A., Sundberg, J.P., Presland, R.B., Fleckman, P., Shimizu, N., Kudoh, J., Irvine, A.D., Amagai, M. & McLean, W.H. (2009). A homozygous frameshift mutation in the mouse Flg gene facilitates enhanced percutaneous allergen priming. *Nature Genetics* Vol.41, No.5, (April 2009) pp. 602-608, ISSN 1061-4036
- Festing, M.F.W. (1996). Origins and characteristics of inbred strains of mice, In: *Genetic Variants and Strains of the Laboratory Mouse*, M.F. Lyon, S. Rastan & S.D.M. Brown, (Ed(s).), pp. 1537-1576, Oxford University Press, ISBN 9780198548690, Oxford
- Geha, R.S. (2003). Allergy and hypersensitivity. Nature versus nurture in allergy and hypersensitivity. *Current Opinion in Immunology*, Vol.15, No.6, (December 2003), pp. 603-608, ISSN 0952-7915
- Hanifin, J.M. (1982). Atopic dermatitis. *Journal of the American Academy of Dermatology*, Vol.6, No.1, (January 1982), pp. 1-13, ISSN 0190-9622

- Hanifin, J.M. & Rajka, G. (1980). Diagnostic features of atopic dermatitis. *Acta Dermato-Venereologica - Supplementum*, Vol.92, pp. 44-47, ISSN 0365-8341
- Haraguchi, M., Hino, M., Tanaka, H. & Maru M. (1997). Naturally occurring dermatitis associated with *Staphylococcus aureus* in DS-Nh mice. *Experimental Animals*, Vol.46, No.3, (July 1997), pp. 225-229, ISSN 1341-1357
- Hikita, I., Yoshioka, T., Mizoguchi, T., Tsukahara, K., Tsuru, K., Nagai, H., Hirasawa, T., Tsuruta, Y., Suzuki, R., Ichihashi, M. & Horikawa T. (2002). Characterization of dermatitis arising spontaneously in DS-Nh mice maintained under conventional conditions: another possible model for atopic dermatitis. *Journal of Dermatological Science*, Vol.30, No.2, (November 2002), pp142-153, ISSN 0923-1811
- Hvid, M., Jensen, H.K., Deleuran, B., Kemp, K., Andersson, C., Deleuran, M. & Vestergaard, C. (2009). Evaluation of FITC-induced atopic dermatitis-like disease in NC/Nga mice and BALB/c mice using computer-assisted stereological toolbox, a computer-aided morphometric system. *International Archives of Allergy & Immunology*, Vol.149, No.3, (February 2009), ISSN 1018-2438
- Imura, K., Yoshioka, T., Hikita, I., Hirasawa, T., Sakata, T., Matsutani, T., Horikawa, T. & Arimura, A. (2008). Association of T-cell receptor Vbeta haplotypes with dry skin in DS-Nh mice. *Clinical & Experimental Dermatology*, Vol.34, No.1, (November 2008), pp. 1365-2230, ISSN 0307-6938
- Imura, K., Yoshioka, T., Hikita, I., Tsukahara, K., Hirasawa, T., Higashino, K., Gahara, Y., Arimura, A. & Sakata, T. (2007). Influence of TRPV3 mutation on hair growth cycle in mice. *Biochemical & Biophysical Research Communications*, Vol.363, No.3, (September 2007), pp. 479-483, ISSN 0006-291X
- Imura, K., Yoshioka, T., Hirasawa, T. & Sakata, T. (2009). Role of TRPV3 in immune response to development of dermatitis. *Journal of Inflammation*, Vol.6, (May 2009) p. 17, ISSN 1476-9255
- Ito, M., Ogawa, K., Takeuchi, K., Nakada, A., Heishi, M., Suto, H., Mitsuishi, K., Sugita, Y., Ogawa, H. & Ra, C. (2004). Gene expression of enzymes for tryptophan degradation pathway is upregulated in the skin lesions of patients with atopic dermatitis or psoriasis. *Journal of Dermatological Science*, Vol.36, No.3, (December 2004), pp. 157-164, ISSN 0923-1811
- Jiang, J., Yamaguchi, T., Funakushi, N., Kuhara, T., Fan, P. S., Ueki, R., Suto, H., Kase, Y., Ikeda, S. & Ogawa, H. (2009) Oral administration of Yokukansan inhibits the development of atopic dermatitis-like lesions in isolated NC/Nga mice. *Journal of Dermatological Science*, Vol. 56, No. 1 (October 2009), pp.37-42, ISSN 0923-1811
- Joo, S.S., Won, T.J., Nam, S.Y., Kim, Y.B., Lee, Y.C., Park, S.Y., Park, H.Y., Hwang, K.W. & Lee do, I. (2009) Therapeutic advantages of medicinal herbs fermented with *Lactobacillus plantarum*, in topical application and its activities on atopic dermatitis. *Phytotherapy Research*, Vol. 23, No. 7, (July 2009), pp.913-919, ISSN 0951-418X
- Jung, K., Tanaka, A., Fujita, H., Matsuda, A., Oida, K., Karasawa, K., Okamoto, N., Ohmori, K., Jee, Y., Shin, T. & Matsuda, H. (2011). Peroxisome proliferator-activated receptor gamma-mediated suppression of dendritic cell function prevents the onset of atopic dermatitis in NC/Tnd mice. *The Journal of Allergy & Clinical Immunology*, Vol.127, No.2, (January 2011), pp. 420-429, ISSN 0091-6749
- Kikkawa, Y., Miura, I., Takahama, S., Wakana, S., Yamazaki, Y., Moriwaki, K., Shiroishi, T. & Yonekawa, H. (2001). Microsatellite database for MSM/Ms and JF1/Ms, molossinus-derived inbred strains. *Mammalian Genome*, Vol.12, No.9, (September 2001), pp. 750-752, 0938-8990 (Print)

- Kikkawa, Y., Oyama, A., Ishii, R., Miura, I., Amano, T., Ishii, Y., Yoshikawa, Y., Masuya, H., Wakana, S., Shiroishi, T., Taya, C. & Yonekawa, H. (2003). A small deletion hotspot in the type II keratin gene *mK6irs1/Krt2-6g* on mouse chromosome 15, a candidate for causing the wavy hair of the caracul (*Ca*) mutation. *Genetics*, Vol.165, No.2, (October 2003), pp. 721-733, ISSN 0016-6731
- Kim, M.S., Hur, Y.G., Kim, W.G., Park, B.W., Ahn, K.S., Kim, J.J. & Bae, H. (2011) Inhibitory effect of *Platycodon grandiflorum* on T(H)1 and T(H)2 immune responses in a murine model of 2,4-dinitrofluorobenzene-induced atopic dermatitis-like skin lesions. *Annals of Allergy, Asthma & Immunology*, vol. 106, No. 1 (January 2011), pp.54-61, ISSN 1081-1206
- Kobayashi, H., Mizuno, N., Kutsuna, H., Teramae, H., Ueoku, S., Onoyama, J., Yamanaka, K., Fujita, N. & Ishii, M. (2003) Hochu-ekki-to suppresses development of dermatitis and elevation of serum IgE level in NC/Nga mice. *Drugs under Experimental and Clinical Research*, vol. 29, No. 2, (September 2003), pp.81-84, ISSN 0378-6501
- Kohara, Y., Tanabe, K., Matsuoka, K., Kanda, N., Matsuda, H., Karasuyama, H. & Yonekawa, H. (2001). A major determinant quantitative-trait locus responsible for atopic dermatitis-like skin lesions in NC/Nga mice is located on Chromosome 9. *Immunogenetics*, Vol. 53, No.9, (February 2001), pp. 15-21, ISSN 0093-7711
- Kondo, K., Tomita, T., Esaki, K., & Hayakawa, J. (March 1983). *Genetic Control of Laboratory Animals* (In Japanese), K., Kondo, T., Tomita, K., Esaki, & J., Hayakawa (Ed(s)). Soft Science, Inc., Tokyo.
- Kondo, K., Nagami, T. & Teramoto, S. (1969). Differences in hematopoietic death among inbred strains of mice. In: *Comparative Cellular & Species Radiosensitivity* (V.P., Bond & T, Sugahara), (Ed(s).), pp. 20-29, Igakushoin, Tokyo
- Kondo, T., Ohno, H., Taguchi, K., Satode, R. & Shiimoto, Y. (2006). Increased susceptibility to *Staphylococcus aureus* colonization of the skin of the NOA mouse: a potentially useful animal model for evaluating antiseptic effects. *Experimental Animals*, Vol.55, No.1, (January 2006), pp. 49-56, ISSN 1341-1357
- Kondo, T., Shiimoto, Y., Kondo, T. & Kubo, S. (1997). The "NOA" mouse; a new hair-deficient mutant (a possible animal model of allergic dermatitis). *Mouse Genome*, Vol.95, No.3, (1997), pp. 698-700, ISSN 0959-0587.
- Larsen, F.S., Holm, N.V. & Henningsen, K. (1986). Atopic dermatitis. A genetic-epidemiologic study in a population-based twin sample. *Journal of the American Academy of Dermatology*, Vol.15, No.3, (September 1986), pp. 487-494, ISSN 0190-9622
- Lee, H.S., Kim, S.K., Han, J.B., Choi, H.M., Park, J.H., Kim, E.C., Choi, M.S., An, H.J., Um, J.Y., Kim, H.M. & Min, B.I. (2006). Inhibitory effects of *Rumex japonicus* Houutt. on the development of atopic dermatitis-like skin lesions in NC/Nga mice. *The British Journal of Dermatology*, Vol.155, No.1, (July 2006), pp. 33-38, ISSN 0007-0963
- Lee, J.K., Ha, H., Lee, H.Y., Park, S.J., Jeong, S.L., Choi, Y.J. & Shin, H.K. (2010) Inhibitory effects of heartwood extracts of *Broussonetia kazinoki* Sieb on the development of atopic dermatitis in NC/Nga mice. *Bioscience, Biotechnology, and Biochemistry*, Vol. 74, No. 9, (September 2010), pp.1802-1806, ISSN 0916-8451
- Lee, S.J., Oh, S.G., Seo, S.W., Ahn, H.J., Geum, D., Cho, J.J. & Park, C.S. (2007) Oral administration of *Astragalus membranaceus* inhibits the development of DNFB-induced dermatitis in NC/Nga mice. *Biological & Pharmaceutical Bulletin*, Vol. 30, No. 8 (August 2007), pp.1468-1471, ISSN 0918-6158
- Leonardi, A., Chariot, A., Claudio, E., Cunningham, K. & Siebenlist, U. (2000). CIKS, a connection to Ikappa B kinase and stress-activated protein kinase. *Proceedings of the*

- National Academy of Sciences of the United States of America*, Vol.97, No.19, (September 2000), pp. 10494-10499, ISSN 0027-8424
- Leung, D.Y. & Bieber, T. (2003). Atopic dermatitis. *Lancet*, Vol.361, No.9352 (January 2003), pp. 151-160, ISSN 0140-6736
- Li, X. (2008). Act1 modulates autoimmunity through its dual functions in CD40L/BAFF and IL-17 signaling. *Cytokine*, Vol.41, No.2, (February 2008) pp. 105-113, ISSN 1043-4666.
- Li X., Commane, M., Nie, H., Hua, X., Chatterjee-Kishore, M., Wald, D., Haag, M. & Stark, G.R. (2000). Act1, an NF-kappa B-activating protein. *Proceedings of the National Academy of Sciences of the United States of America*, Vol. 97, No.19, (September 2000), pp. 10489-10493, ISSN 0027-8424
- Mak, K.K. & Chan, S.Y. (2003). Epidermal growth factor as a biologic switch in hair growth cycle. *The Journal of Biological Chemistry*, Vol.278, No.28, (July 2003), pp.26120-26126, ISSN 0021-9258
- Matsuda, H., Watanabe, N., Geba, G.P., Sperl, J., Tsudzuki, M., Hiroi, J., Matsumoto, M., Ushio, H., Saito, S., Askenase, P.W. & Ra, C. (1997). Development of atopic dermatitis-like skin lesion with IgE hyperproduction in NC/Nga mice. *International Immunology*, vol.9, No.3, (March 1997), pp. 461-466, ISSN 0953-8178
- Matsui, E.C., Krop, E.J., Diette, G.B., Aalberse, R.C., Smith, A.L. & Eggleston, P.A. (2004). Mouse allergen exposure and immunologic responses: IgE-mediated mouse sensitization and mouse specific IgG and IgG4 levels. *Annals of Allergy, Asthma, & Immunology*, Vol.93, No.2, (August 2004), pp.171-178, ISSN 1081-1206
- Matsushima, Y., Kikkawa, Y., Takada, T., Matsuoka, K., Seki, Y., Yoshida, H., Minegishi, Y., Karasuyama, H. & Yonekawa, H. (2010). An atopic dermatitis-like skin disease with hyper-IgE-emia develops in mice carrying a spontaneous recessive point mutation in the *Traf3ip2* (Act1/CIKS) gene. *Journal of Immunology*, Vol.185, No.4, (August 2010), pp.2340-2349, ISSN 0022-1767
- Moniaga, C.S., Egawa, G., Kawasaki, H., Hara-Chikuma, M., Honda, T., Tanizaki, H., Nakajima, S., Otsuka, A., Matsuoka, H., Kubo, A., Sakabe, J., Tokura, Y., Miyachi, Y., Amagai, M. & Kabashima, K. (2010) Flaky tail mouse denotes human atopic dermatitis in the steady state and by topical application with *Dermatophagoides pteronyssinus* extract. *The American Journal of Pathology*, Vol. 176, No. 5 (May 2010), pp.2385-2393, ISSN 0002-9440.
- Morar, N., Willis-Owen, S.A., Moffatt, M.F. & Cookson, W.O. (2006). The genetics of atopic dermatitis. *The Journal of Allergy & Clinical Immunology*, Vol.118, No.1, (July 2006), pp. 24-34, ISSN 0091-6749
- Morita, E., Kaneko, S., Hiragun, T., Shindo, H., Tanaka, T., Furukawa, T., Nobukiyo, A. & Yamamoto, S. (1999). Fur mites induce dermatitis associated with IgE hyperproduction in an inbred strain of mice, NC/Kuj. *Journal of Dermatological Science* Vol.19, No.1, (January 1999), pp. 37-43, ISSN 0923-1811
- Moriwaki, K., Miyashita, N., Mita, A., Gotoh, H., Tsuchiya, K., Kato, H., Mekada, K., Noro, C., Oota, S., Yoshiki, A., Obata, Y., Yonekawa, H. & Shiroishi, T. (2009). Unique inbred strain MSM/Ms established from the Japanese wild mouse. *Experimental Animals*, Vol. 58, No.2, (April 2009), pp. 123-134, ISSN 1341-1357
- Naglich, J.G., Metherall, J.E., Russell, D.W. & Eidels, L. (1992a). Expression cloning of a diphtheria toxin receptor: identity with a heparin-binding EGF-like growth factor precursor. *Cell*, Vol.69, No.6, (June 1992), pp. 1051-1061, ISSN 0092-8674
- Naglich, J.G., Rolf, J.M & Eidels, L. (1992b). Expression of functional diphtheria toxin receptors on highly toxin-sensitive mouse cells that specifically bind radioiodinated

- toxin. *Proceedings of the National Academy of Sciences of the United States of America*, Vol.89, No.6, (March 1992), pp. 2170-2174, ISSN 0027-8424
- Natori, K., Tamari, M., Watanabe, O., Onouchi, Y., Shiimoto, Y., Kubo, S. & Nakamura, Y. (1999). Mapping of a gene responsible for dermatitis in NOA (Naruto Research Institute Otsuka Atrichia) mice, an animal model of allergic dermatitis. *Journal of Human Genetics*, Vol.44, No.6, (August 1999), pp. 372-376, ISSN 1434-5161
- Novak, N., Bieber, T. & Leung, D.Y. (2003). Immune mechanisms leading to atopic dermatitis. *The Journal of Allergy and Clinical Immunology*, Vol.112, No.6 Suppl, (December 2003), pp. S128-139, ISSN 0091-6749
- Ogawa, K., Ito, M., Takeuchi, K., Nakada, A., Heishi, M., Suto, H., Mitsuishi, K., Sugita, Y., Ogawa, H. & Ra, C. (2005). Tenascin-C is upregulated in the skin lesions of patients with atopic dermatitis. *Journal of Dermatological Science*, Vol.40, No.1, (October 2005), pp. 35-41, ISSN 0923-1811
- Okuhara, D.Y., Hsia, A.Y. & Xie, M. (2007). Transient receptor potential channels as drug targets. *Expert Opinion on Therapeutic Targets*, Vol.11, No.3, (March 2007), pp. 391-401, ISSN 1472-8222
- O'Regan, G.M. & Irvine, A.D. (2010) The role of filaggrin in the atopic diathesis. *Clinical and Experimental Allergy : Journal of the British Society for Allergy and Clinical Immunology*, Vol. 40, No. 7 (July 2010) pp.965-972, ISSN 0954-7894.
- Oyoshi, M.K., Murphy, G.F. & Geha, R.S. (2009) Filaggrin-deficient mice exhibit TH17-dominated skin inflammation and permissiveness to epicutaneous sensitization with protein antigen. *The Journal of Allergy and Clinical Immunology* Vol.124, No. 3, (September 2009) p.p. 485-493, 493 e481, ISSN 0091-6749.
- Pacheco, K.A., McCammon, C., Liu, A.H., Thorne, P.S., O'Neill, M.E., Martyny, J., Newman, L.S., Hamman, R.F. & Rose, C.S. (2003). Airborne endotoxin predicts symptoms in non-mouse-sensitized technicians and research scientists exposed to laboratory mice. *American Journal of Respiratory & Critical Care Medicine*, Vol.167, No.7, (April 2003), pp. 983-990, ISSN 1073-449X
- Panteleyev, A.A., Botchkareva, N.V., Sundberg, J.P., Christiano, A.M. & Paus, R. (1999). The role of the hairless (*hr*) gene in the regulation of hair follicle catagen transformation. *The American Journal of Pathology*, Vol.155, No.1, (July 1999), pp. 159-171, ISSN 0002-9440
- Park, K.H., Choi, S.E., Choi, Y.W., Lee D.I., Joo, S.S., Jeong, M.S., Bang, H., Lee, C.S., Seo, S.J. & Lee, M.W. (2011) Topical application of two condensed tannins from the root of *Rosa multiflora* Thunberg for the treatment of atopic dermatitis (AD) in NC/Nga Mice. *Phytotherapy Research*, (June 2011), ISSN 0951-418X
- Peier, A.M., Reeve, A.J., Andersson, D.A., Moqrich, A., Earley, T.J., Hergarden, A.C., Story, G.M., Colley, S., Hogenesch, J.B., McIntyre, P., Bevan, S. & Patapoutian, A. (2002). A heat-sensitive TRP channel expressed in keratinocytes. *Science* Vol.296, No.5575, (June 2002), pp. 2046-2049, ISSN 0193-4511
- Poirier, C., Yoshiki, A., Fujiwara, K., Guenet, J.L. & Kusakabe M. (2002). Hague (*Hag*). A new mouse hair mutation with an unstable semidominant allele. *Genetics*, Vol.162, No.2, (October 2002), pp. 831-840, ISSN 0016-6731
- Saito, M., Iwawaki, T., Taya, C., Yonekawa, H., Noda, M., Inui, Y., Mekada, E., Kimata, Y., Tsuru, A. & Kohno K. (2001). Diphtheria toxin receptor-mediated conditional and targeted cell ablation in transgenic mice. *Nature Biotechnology*, Vol.19, No.8, (August 2001), pp. 746-750, ISSN 1087-0156
- Sakai, T., Kikkawa, Y., Miura, I., Inoue, T., Moriwaki, K., Shiroishi, T., Satta, Y., Takahata, N. & Yonekawa, H. (2005). Origins of mouse inbred strains deduced from whole-

- genome scanning by polymorphic microsatellite loci. *Mammalian Genome*, Vol.16, No.1, (January 2005), pp. 11-19, ISSN 0938-8990
- Sasakawa, T., Higashi, Y., Sakuma, S., Hirayama, Y., Sasakawa, Y., Ohkubo, Y., Goto, T., Matsumoto, M. & Matsuda H. (2001). Atopic dermatitis-like skin lesions induced by topical application of mite antigens in NC/Nga mice. *International Archives of Allergy & Immunology*, Vol.126, No.3, (November 2001), pp. 239-247, ISSN 1018-2438
- Schultz Larsen, F. (1993). Atopic dermatitis: a genetic-epidemiologic study in a population-based twin sample. *Journal of the American Academy of Dermatology*, Vol.28, No. 5 Pt 1, (May, 1993), pp. 719-723, ISSN 0190-9622
- Schweitzer, I.B., Smith, E., Harrison, D.J., Myers, D.D., Eggleston, P.A., Stockwell, J.D., Paigen, B. & Smith, A.L. (2003). Reducing exposure to laboratory animal allergens. *Comparative Medicine*, Vol.53, No.5, (October 2003), pp. 487-492, ISSN 1532-0820
- Shah, M.M., Miyamoto, Y., Yamada, Y., Yamashita, H., Tanaka, H., Ezaki, T., Nagai, H. & Inagaki, N. (2010). Orally supplemented *Lactobacillus acidophilus* strain L-92 inhibits passive and active cutaneous anaphylaxis as well as 2,4-dinitrofluorobenzene and mite fecal antigen induced atopic dermatitis-like skin lesions in mice. *Microbiology and Immunology*, Vol.54, No.9, (September 2010), pp. 523-533, ISSN 0385-5600
- Sung, Y.Y., Yoon, T., Jang, J.Y., Park, S.J., Jeong, G.H. & Kim, H.K. (2011a) Inhibitory effects of *Cinnamomum cassia* extract on atopic dermatitis-like skin lesions induced by mite antigen in NC/Nga mice. *Journal of Ethnopharmacology*, Vol.133, No. 2 (January 2010), pp. 621-628, ISSN 0378-8741
- Sung, Y.Y., Yoon, T., Jang, J.Y., Park, S.J. & Kim, H.K. (2011b) Topical application of *Rehmannia glutinosa* extract inhibits mite allergen-induced atopic dermatitis in NC/Nga mice. *Journal of Ethnopharmacology*, Vol. 134, No. 1 (March 2010), pp.37-44, ISSN 0378-8741
- Takada, T., Mita, A., Maeno, A., Sakai, T., Shitara, H., Kikkawa, Y., Moriwaki, K., Yonekawa, H. & Shiroishi, T. (2008a). Mouse inter-subspecific consomic strains for genetic dissection of quantitative complex traits. *Genome Research*, Vol.18, No.3, (March 2008), pp. 500-508, ISSN 1088-9051
- Takada, T., Shitara, H., Matsuoka, K., Kojima, E., Ishii, R., Kikkawa, Y., Taya, C., Karasuyama, H., Kohno, K. & Yonekawa, H. (2008b). A novel hairless mouse model on an atopic dermatitis-prone genetic background generated by receptor-mediated transgenesis. *Transgenic Research*, Vol.17, No.6, (December 2008), pp. 1155-1162, ISSN 0962-8819
- Takeda, K. & Gelfand, E.W. (2009). Mouse models of allergic diseases. *Current Opinion in Immunology*, Vol.21, No.6, (December 2009), pp. 660-665, ISSN 0952-7915
- Tanaka, A. & Matsuda, H. (2011). Evaluation of itch by using NC/NgaTnd mice: a model of human atopic dermatitis. *Journal of Biomedicine & Biotechnology*, Vol.2011, (December 2010), 790436, ISSN 1110-7243
- Taniguchi, Y., Kohno, K., Inoue, S., Koya-Miyata, S., Okamoto, I., Arai, N., Iwaki, K., Ikeda, M. & Kurimoto, M. (2003). Oral administration of royal jelly inhibits the development of atopic dermatitis-like skin lesions in NC/Nga mice. *International Immunopharmacology*, Vol.3, No.9, (September 2003), pp. 1313-1324, ISSN 1567-5769
- Taylor, B., Wadsworth, J., Wadsworth, M. & Peckham, C. (1984) Changes in the reported prevalence of childhood eczema since the 1939-45 war. *Lancet*, Vol.2, No.8414, (December 1984), pp. 1255-1257, ISSN 0140-6736
- Tomimori, Y., Muto, T., Fukami, H., Saito, K., Horikawa, C., Tsuruoka, N., Saito, M., Sugiura, N., Yamashiro, K., Sumida, M., Kakutani, S. & Fukuda, Y. (2002). Chymase participates in chronic dermatitis by inducing eosinophil infiltration. *Laboratory*

- Investigation; a Journal of Technical Methods and Pathology*, Vol. 82, No.6, (June 2002), pp. 789-794, ISSN 0023-6837
- Tomimori, Y., Tanaka, Y., Goto, M. & Fukuda, Y. (2005). Repeated topical challenge with chemical antigen elicits sustained dermatitis in NC/Nga mice in specific-pathogen-free condition. *The Journal of Investigative Dermatology*, Vol.124, No.1, (January 2005), pp. 119-124, ISSN 0022-202X
- Vercelli, D. (2009) Of flaky tails and itchy skin. *Nature Genetics*, Vol.41, No. 5, (May 2009), pp.512-513, ISSN 1061-4036.
- Watanabe, A., Takeuchi, M., Nagata, M., Nakamura, K., Hirasawa, T., Nakao, H., Makino, S. & Harada, M. (2003a). Spontaneous development of dermatitis in DS-Nh mice under specific pathogen-free conditions. *Experimental Animals*, Vol.52, No.1, (January 2003), pp. 77-80, ISSN 1341-1357
- Watanabe, A., Takeuchi, M., Nagata, M., Nakamura, K., Nakao, H., Yamashita, H., Makino, S., Harada, M. & Hirasawa, T. (2003b). Role of the Nh (Non-hair) mutation in the development of dermatitis and hyperproduction of IgE in DS-Nh mice. *Experimental Animals*, Vol. 52, No.5, (October 2003), pp. 419-423, ISSN 1341-1357
- Watanabe, O., Natori, K., Tamari, M., Shiimoto, Y., Kubo, S. & Nakamura Y. (1999) Significantly elevated expression of PF4 (platelet factor 4) and eotaxin in the NOA mouse, a model for atopic dermatitis. *Journal of Human Genetics*, Vol.44, No.3, (January 1999), 173-176, ISSN 1434-5161
- Watanabe, O., Tamari, M., Natori, K., Onouchi, Y., Shiimoto, Y., Hiraoka, I. & Nakamura, Y. (2001). Loci on murine chromosomes 7 and 13 that modify the phenotype of the NOA mouse, an animal model of atopic dermatitis. *Journal of Human Genetics*, Vol.46, No.4, (January 2001), pp. 221-224, ISSN 1434-5161
- Wise, F. & Sulzberger, M.B. (1993). Footnote on problems of eczema, neurodermatitis and lichenification. In: *Year Book of Dermatology & Syphilology*, F., Wise & M.B., Sulzberger, (Ed(s).), pp. 38-39, Year Book Publishers, ISBN 0093-3627, Chicago
- Wu, G., Li, L., Sung, G.H., Kim, T.W., Byeon, S.E., Cho, J.Y., Park, C.W. & Park, H.J. (2011) Inhibition of 2,4-dinitrofluorobenzene-induced atopic dermatitis by topical application of the butanol extract of *Cordyceps bassiana* in NC/Nga mice. *Journal of Ethnopharmacology*, Vol. 134, No. 2, (March 2010), pp.504-509, ISSN 0378-8741
- Yamamoto, M., Haruna, T., Yasui, K., Takahashi, H., Iduhara, M., Takaki, S., Deguchi, M. & Arimura, A. (2007). A novel atopic dermatitis model induced by topical application with *Dermatophagoides farinae* extract in NC/Nga mice. *Allergology International*, Vol.56, No.2, (June 2007), pp. 139-148, ISSN 1323-8930
- Yoshioka, T., Hikita, I., Asakawa, M., Hirasawa, T., Deguchi, M., Matsutani, T., Oku, H., Horikawa, T. & Arimura, A. (2006). Spontaneous scratching behaviour in DS-Nh mice as a possible model for pruritus in atopic dermatitis. *Immunology*, Vol. 118, No.3, (July 2006), pp. 293-301, ISSN 0019-2805
- Yoshioka, T., Imura, K., Asakawa, M., Suzuki, M., Oshima, I., Hirasawa, T., Sakata, T., Horikawa, T. & Arimura, A. (2009). Impact of the Gly573Ser substitution in TRPV3 on the development of allergic and pruritic dermatitis in mice. *The Journal of Investigative Dermatology*, Vol.129, No.3, (March, 2009), pp. 714-722, ISSN 0022-202X
- Yoshioka, T., Imura, K., Hikita, I., Hirasawa, T., Sakata, T., Matsutani, T., Horikawa, T. & Arimura, A. (2007). Impact of T-cell receptor Vbeta haplotypes on the development of dermatitis in DS-Nh mice: synergistic production of interleukin-13 caused by staphylococcal enterotoxin C and peptide glycans from *Staphylococcus aureus*. *Immunology*, vol. 121, No.1, (May 2007), pp 51-61, ISSN 0019-2805

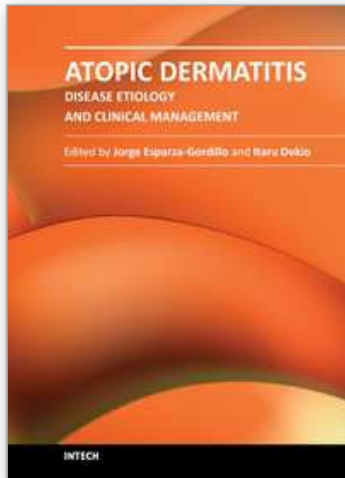

Atopic Dermatitis - Disease Etiology and Clinical Management

Edited by Dr. Jorge Esparza-Gordillo

ISBN 978-953-51-0110-9

Hard cover, 414 pages

Publisher InTech

Published online 22, February, 2012

Published in print edition February, 2012

Atopic Dermatitis is a common disease characterized by inflamed, itching and dry skin. This relapsing allergic disorder has complex etiology and shows a remarkably high clinical heterogeneity which complicates the diagnosis and clinical management. This book is divided into 4 sections. The first section (Disease Etiology) describes some of the physiological mechanisms underlying Atopic Dermatitis, including alterations in the immune system and the skin-barrier function. The important role of host-microorganism interactions on the pathophysiology of Atopic Dermatitis is discussed in the second section (Microorganisms in Atopic Dermatitis). An overview of the clinical diagnostic criteria and the disease management protocols commonly used is given in the third section (Diagnosis and Clinical Management). The last section (New Treatments) describes new therapeutic approaches that are not widely used but are currently being studied due to preliminary evidence showing a clinical benefit for Atopic Dermatitis.

How to reference

In order to correctly reference this scholarly work, feel free to copy and paste the following:

Hiromichi Yonekawa, Toyoyuki Takada, Hiroshi Shitara, Choji Taya, Yoshibumi Matsushima, Kunie Matsuoka and Yoshiaki Kikkawa (2012). Mouse Models for Atopic Dermatitis Developed in Japan, *Atopic Dermatitis - Disease Etiology and Clinical Management*, Dr. Jorge Esparza-Gordillo (Ed.), ISBN: 978-953-51-0110-9, InTech, Available from: <http://www.intechopen.com/books/atopic-dermatitis-disease-etiology-and-clinical-management/mouse-models-for-atopic-dermatitis-developed-in-japan>

INTECH
open science | open minds

InTech Europe

University Campus STeP Ri
Slavka Krautzeka 83/A
51000 Rijeka, Croatia
Phone: +385 (51) 770 447
Fax: +385 (51) 686 166
www.intechopen.com

InTech China

Unit 405, Office Block, Hotel Equatorial Shanghai
No.65, Yan An Road (West), Shanghai, 200040, China
中国上海市延安西路65号上海国际贵都大饭店办公楼405单元
Phone: +86-21-62489820
Fax: +86-21-62489821

© 2012 The Author(s). Licensee IntechOpen. This is an open access article distributed under the terms of the [Creative Commons Attribution 3.0 License](#), which permits unrestricted use, distribution, and reproduction in any medium, provided the original work is properly cited.

IntechOpen

IntechOpen