

We are IntechOpen, the world's leading publisher of Open Access books Built by scientists, for scientists

5,400

Open access books available

133,000

International authors and editors

165M

Downloads

Our authors are among the

154

Countries delivered to

TOP 1%

most cited scientists

12.2%

Contributors from top 500 universities



WEB OF SCIENCE™

Selection of our books indexed in the Book Citation Index
in Web of Science™ Core Collection (BKCI)

Interested in publishing with us?
Contact book.department@intechopen.com

Numbers displayed above are based on latest data collected.
For more information visit www.intechopen.com



Radioisotope Power Systems for Space Applications

Antonio Sanchez-Torres

*Universidad Politécnica de Madrid, Escuela Técnica Superior de Ingenieros Aeronáuticos,
Departamento de Física Aplicada,
Spain*

1. Introduction

At the beginning of the Space Age, both propulsion and power generation in the spacecraft has been the main issue for consideration. Considerable research has been carried out on technologies by several Space Agencies to reach outer planets and generate electric power for the systems and subsystems in the spacecraft (SC). Various types of power source such as solar photovoltaic, Radioisotope power systems (RPS) have been used by Space Agencies. New technology such as reactor based, electric solar sail and electrodynamic bare tethers might be used in the future for both propulsion and power generation. Mainly, both NASA and Russian Agency worked separately using nuclear technology to obtain more efficiency in their systems for deep space exploration.

Radioisotope Power Systems (RPS), is a nuclear-powered system to generate electric power to feed communication and scientific systems on a spacecraft. Radioisotope Thermoelectric Generators (RTGs), a type of Radioisotope Power System, were used in the past as electric power supplies for some navigational and meteorological missions, and most outer-planet missions. Radioisotope power systems use the natural decay of radionuclides produced by a nuclear reactor. The expensive, man-made Plutonium-238 (^{238}Pu) is the appropriate source of energy used in RPS fueling; its long half-life (~87 years) guarantees long time missions. The limited availability of Plutonium-238 is inadequate to support scheduled NASA mission beyond 2018. After the Cold War, throughout the Non-Proliferation of Nuclear Weapons Treaty, the production and processing of these resources have been severally reduced. There is a high-priority recommendation to reestablish production to solve the severe ^{238}Pu demand problem (National Research Council, 2009).

The isotope initially selected for terrestrial and space power applications was Cerium-144 because it is one of the most useful fission products available from nuclear reactor (Furlog, 1999; Lange, 2008). Its short half-life (about 290 days) made Cerium-144 compatible with a possible short-time mission. However, the high radiation associated with a powerful beta/gamma emission produces several problems with the payload interaction and safety in the case of reentry orbit. The development of RTGs was assigned to The Atomic Energy Commission in 1955. The first system developed for space situation was the System for Nuclear Auxiliary Power (SNAP). The Cerium-144 fueled SNAP-1 power system was never used in space. The first flight with a RTG was SNAP-3 in 1961 delivering 11.6 kW over a 280 days period, using as fueling Polonium-210 (Po-210) isotope. Po-210 is an alpha emitter with

a very high power density and low radiation emissions. Since Po-210 has short half-life (138 days), space missions are highly limited. The early RTGs developed a specific power slightly larger than 1 W/kg. SNAP-9A system reached 20 W/kg whereas later systems such as Galileo developed 5.4 W/kg (Brown, 2001; Griffin, 2004). Several past missions have used RPS as it shown in Table 1. Table 2 shows several future missions that will use RPS as main power system.

| Power source (number) | Spacecraft | Mission type | Launch |
|-------------------------|----------------------|----------------|--------|
| SNAP-3 RTG (1) | Transit 4A | Navigational | 1961 |
| SNAP-3 RTG (1) | Transit 4B | Navigational | 1961 |
| SNAP-9A RTG (1) | Transit 5BN-1 | Navigational | 1963 |
| SNAP-9A RTG (1) | Transit 5BN-2 | Navigational | 1963 |
| SNAP-9A RTG (1) | Transit 5BN-3 | Navigational | 1964 |
| SNAP-10A Reactor | Snapshot | Experimental | 1965 |
| SNAP-19B RTG (2) | Nimbus B-1 | Meteorological | 1968 |
| SNAP-19B RTG (2) | Nimbus III | Meteorological | 1969 |
| ALRH Heater | Apollo 11 | Lunar | 1969 |
| SNAP-27 RTG (1) | Apollo 12 | Lunar | 1969 |
| SNAP-27 RTG (1) | Apollo 13 | Lunar | 1970 |
| SNAP-27 RTG (1) | Apollo 14 | Lunar | 1971 |
| SNAP-27 RTG (1) | Apollo 15 | Lunar | 1971 |
| SNAP-19 RTG (4) | Pioneer 10 | Planetary | 1972 |
| SNAP-27 RTG (1) | Apollo 16 | Lunar | 1972 |
| Transit-RTG (1) | Triad-01-1X | Navigational | 1972 |
| SNAP-27 RTG (1) | Apollo 17 | Lunar | 1972 |
| SNAP-19 RTG (4) | Pioneer 11 | Planetary | 1973 |
| SNAP-19 RTG (2) | Viking 1 | Planetary | 1975 |
| SNAP-19 RTG (2) | Viking 2 | Planetary | 1975 |
| MHW-RTG (4) | LES 8, LES 9 | Communication | 1976 |
| MHW-RTG (3) | Voyager 2 | Planetary | 1977 |
| MHW-RTG (3) | Voyager 1 | Planetary | 1977 |
| GPHS-RTG (2) RHU Heater | Galileo | Planetary | 1989 |
| GPHS-RTG (1) | Ulysses | Planetary | 1990 |
| RHU Heater (3) | Mars Pathfinder | Planetary | 1996 |
| GPHS-RTG (2) RHU Heater | Cassini | Planetary | 1997 |
| RHU Heater (8) | Mars MER Spirit | Mars rover | 2003 |
| RHU Heater (8) | Mars MER Opportunity | Mars rover | 2003 |
| GPHS-RTG (1) | New Horizons | Planetary | 2006 |

Table 1. US spacecraft with RPS

The RTG fuel must be produced in adequate quantities with appropriate nuclear safety requirements for space missions. There are only a limited number of radioisotopes available for space power system applications. Using isotopes with pure low-energy beta emission would eliminate the requirements to shield against gamma radiation. Low energy particles

would also generate low energy bremsstrahlung x rays that is easy to shield against. This suggests isotopes such as T^3 , Ni^{63} , Sr^{90} , Tc^{99} , Pw^{147} , Curium-242 and Curium-244 are other possibilities.

When solar panels cannot be used efficiently for planetary missions, RPS becomes the best available alternative. Typical RTG structure consists basically on a couple of metallic conductor, with hot and cold end-connectors. The system operates under thermoelectric generation principle, the so-called Seebeck effect. Heating one end from the natural decay of a radioactive isotope and the other end keeping cold, the gradient of temperature between two ends will produce a voltage drop. Connecting the terminals through a resistive load causes an amount of current flowing in the electric external circuit, and then generating electric power.

Considerable research has been carried out to develop new technologies to improve RTG efficiency using more efficient thermoelectric materials with low thermal conductivity. The dynamic conversion systems, which convert partially the thermal energy in the fluid into mechanical work to drive an alternator to produce electricity, would provide higher electric power per unit mass, reducing the amount of Plutonium-238 required.

| Power source (number) | Spacecraft | Mission type | Launch |
|-----------------------|--|-----------------|-----------|
| RHU Heater (1-4) | Europa Impactor Micro-Lander | Planetary | 2015 |
| RHU Heater (1-4) | Titan Micro-Rover | rover | 2015 |
| GPHS (1) | Europa Lander | Planetary | 2015 |
| GPHS (1) | Titan Moon Lander | Planetary | 2015 |
| GPHS (1) | Ganymede Lander | Planetary | 2015 |
| GPHS (1) | Callisto Lander | Planetary | 2015 |
| GPHS (1) | Titan Rough Lander | Planetary | 2015 |
| GPHS (1) | Europa Rough Lander | Planetary | 2015 |
| GPHS (1) | Callisto Orbiter Subsatellite | Planetary | 2015 |
| GPHS (1) | Ganymede Orbiter Subsatellite | Planetary | 2015 |
| GPHS (1) | Europa Orbiter Subsatellite | Planetary | 2015 |
| GPHS (1) | Outer Planets Magnetosphere Subsatellite | Planetary | 2015 |
| GPHS (2-4) | Titan Rover | Rover | 2015 |
| GPHS (1) | Titan Amphibius Rover | Amphibius Rover | 2015 |
| GPHS (1-3) | Lander Amorphor. Rover Array Mini-Lander | Planetary | 2020 |
| MMRTG-ASRG | Jupiter Europa Orbiter | Planetary | 2020 |
| RHU Heater (7-9) | Prospecting Asteroid Mission Micro-Sat | Planetary | 2020-2030 |
| RHU Heater (7-9) | Saturn Autonomous Ring Array Micro-Sat | Planetary | 2020-2030 |

Table 2. Several US future missions with RPS

In section 2 we review the fuel requirements for an optimal RPS. The main part of the RPS, the well-known General Purpose Heat Source, is described in section 3. In section 4 we study the static conversion energy (without movable parts), analyzing thermoelectric effects in the conductors. Additionally, we describe both RTG and Multi-Mission-RTG structures and principle characteristics. The dynamic conversion energy is reviewed in detail in section 5, focusing on Stirling and Brayton power systems. Due to Planetary Protections Requirements, some tentative outer-planets missions like Jovian moons exploration in Europa Jupiter System or re-entry missions which use RPS have to be safety enough. In section 6, we review the safety models for possible RPS accidents. In section 7, RTG will be compared with solar arrays. Conclusions are written in section 8.

2. Radioisotopes for power generation

At least 1300 radioisotopes, both natural and man-made, are available for terrestrial and space applications. Many are generated in both nuclear reactors and particle accelerators. The initial activity of the isotope is

$$A_0 = \lambda N_0 \text{ [Bq]} \quad (1)$$

where N_0 is the initial isotope amount and $\lambda = \ln(2/t_{1/2})$ is the decay constant of the isotope for a $t_{1/2}$ half-life. Table 3 shows several characteristics of useful radioisotopes for RPS. The specific electrical power generated by the heat of the source is given by

$$P_0 = 1.6 \cdot 10^{-13} \eta \times \frac{E[\text{MeV}] \lambda [\text{s}^{-1}] N_A [\text{nuclei/mol}]}{M[\text{amu}]} \quad (2)$$

where η is the conversion efficiency from thermal energy to electricity, E is the energy release per decay, N_A is the Avogadro's number and M the atomic mass.

| Isotope | Radiation emission | $t_{1/2}$ | Specific Power (W/g) |
|----------------|-------------------------|-------------|----------------------|
| Tritium-3 | β^- , no γ | 12.3 years | 0.26 |
| Cobalt-60 | β^- , γ | 83.8 days | 17.70 |
| Nickel-63 | β^- , no γ | 100.1 years | 0.002 |
| Krypton-85 | β^- , γ | 10.7 years | 0.62 |
| Strontium-90 | β^- , no γ | 29.0 years | 0.93 |
| Ruthenium-108 | β^- , no γ | 1.0 years | 33.10 |
| Cesium-137 | β^- , γ | 30.1 years | 0.42 |
| Cerium-144 | β^- , γ | 284.4 days | 25.60 |
| Promethium-147 | β^- , γ | 2.6 years | 0.33 |
| Polonium-210 | α , γ | 136.4 days | 141.00 |
| Plutonium-238 | α , γ | 87.7 years | 0.56 |
| Americium-241 | α , γ | 432 years | 0.11 |
| Curium-242 | α , γ | 162.8 days | 120.00 |
| Curium-244 | α , γ | 18.1 years | 2.84 |

Table 3. Characteristics of isotopes useful for RPS. Notice both high $t_{1/2}$ and specific power of the Plutonium-238

The radioisotope fuel must be not be very expensive. Additionally, the radionuclide proposed has to be easily shielded against deep penetration radiation, as gamma radiation, avoiding the destruction of the electronic components on the spacecraft onboard. The fuel capsule must withstand impact against the ground at high velocity in case of a rocket launch failure, and an Earth-reentry situation. These accidents will be described in section 6.

High P_0 and $t_{1/2}$ half-life values are required for space applications, reducing the valuable radioisotopes. Isotopes without powerful radiation such as gamma or beta is also required. The negative beta emitters can be recovered abundantly from fission fuel reprocessing plants. The alpha emitters with weak gammas are easier to shield. However, they are more expensive than the beta emitters.

The radionuclide most used in RPS, Plutonium-238, is produced by the isotope Np-237. Using U^{238} in the nuclear reactor, the isotope Np^{238} is produced by decay reaction

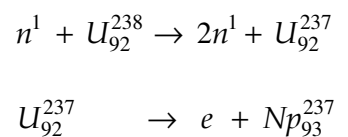

Separating Np^{237} from reactor fuel and further irradiated in a neutron flux, the plutonium required is generated by

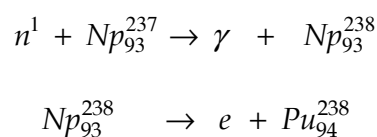

The Plutonium-238 is selected for both high $t_{1/2}$ and specific power, producing heat by emitting alpha particles. The fuel is prepared in the form of pure plutonium oxide (PuO_2) with 0.7 ppm Plutonium-238 and less than 0.5 percent Thorium-238 and Uranium-232.

3. General purpose heat source

The appropriate isotope combined with other components create a heat source that efficiently transfer the isotope heat to electrical power. The most used system for space missions is the general purpose heat source (GPHS). Fig. 1 shows the GPHS structure used in missions such as Galileo, Ulysses, and Cassini. Each module is designed to produce about 250 W at the beginning of mission. Its weight is about 1.43 kg, and its size and shape are selected to survive orbital reentry and post-impact into the ground at high terminal velocity. Typical dimensions are 9.72 cm × 9.32 cm × 5.31 cm.

Each GPHS module contains four pressed PuO_2 fuel pellets. Both diameter and length of the cylindrical fuel pellet is about 2.75 cm. An iridium alloy containment shell and clad made of 0.05 cm aluminum thickness encapsulate the fuel pellet. The iridium alloy is made to resist oxidation in a post-impact environment scenario. The fueled clad is the combination of fuel pellet and cladding.

Two of these clads are confined in a Graphite Impact Shell (GIS) made of carbon material. The GIS structure is designed to decrease the damage to the iridium clads during a possible free-fall accident. Two GISs are inserted into an aeroshell that is composed in graphite material. A thermal insulation layer of carbon-fiber cover each GIS decreasing the high temperature supported to the clads during atmospheric reentry heating. The aeroshell

provides protection against surfaces. Step 1 GPHS module, which is used on the New Horizons exploration mission to Pluto, improves the initial GPHS device including an aeroshell between the two GISs. A second aeroshell improvement, known as Step 2 GPHS module, gives additional protection in the clads for hypervelocity reentry into the atmosphere (Benett, 2006; Brown, 2001; Griffin, 2004; Hastings, 2004).

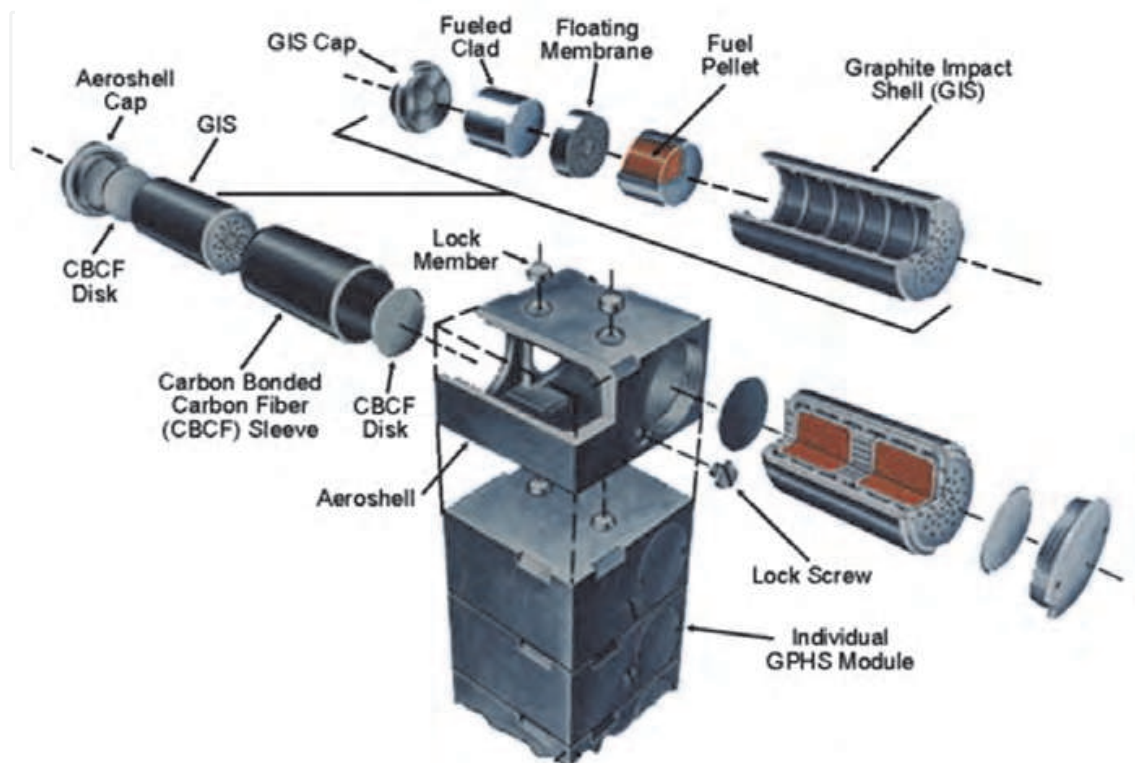

Fig. 1. General purpose heat source (GPHS) structure. (Source NASA/DOE/JPL)

4. Static conversion energy

The static conversion energy use the well-known thermoelectric or Seebeck effect. The thermoelectric effects in metals depend on the electronic structure of the materials. A temperature difference between two points in a conductor or semiconductor results in a voltage difference between these two regions. The Seebeck coefficient gives the magnitude of this effect. The thermoelectric voltage generated per unit temperature difference in a conductor is called the Seebeck coefficient.

Consider a metallic rod that is heated at one end and cooled at the other end as represented in Fig. 2. Since the electrons in the hot region are more energetic with greater velocities than those in the cold region, the electrons from the hot end diffuses toward the cold part. This situation prevails until the electric field developed between the positive ions in the hot region and the excess electrons in the cold region prevents further electron motion from the hot to cold end. A voltage is therefore gathered between the hot and cold ends with hot end at positive potential. The Seebeck coefficient S is given by the potential-to-temperature difference ratio

$$S = \frac{\Delta V}{\Delta T}, \quad (3)$$

where ΔV is the potential difference across a piece of metal due to a temperature difference ΔT . The sign of the Seebeck coefficient represents the potential of the cold side with respect to the hot side. For electrons diffusing from hot to cold end, the cold side is negative with respect to the hot side, making $S < 0$. Since the Seebeck coefficient depends on temperature, the voltage between two hot/cold regions is

$$\Delta V = \int_{T_i}^T S dT. \quad (4)$$

Using the Fermi-Dirac distribution, the average energy E_{av} per electron in a metal is given by

$$E_{av} = \frac{3}{5} E_{F0} \left[1 + \frac{5\pi^2}{12} \left(\frac{kT}{E_{F0}} \right)^2 \right], \quad (5)$$

where E_{F0} is the Fermi energy at 0 K. The average energy in the hot end is greater, and energetic electrons in the hot end diffuse toward the cold region until the potential prevents further diffusion. Notice that the average energy in Eq. (5) also depends on the material through E_{F0} .

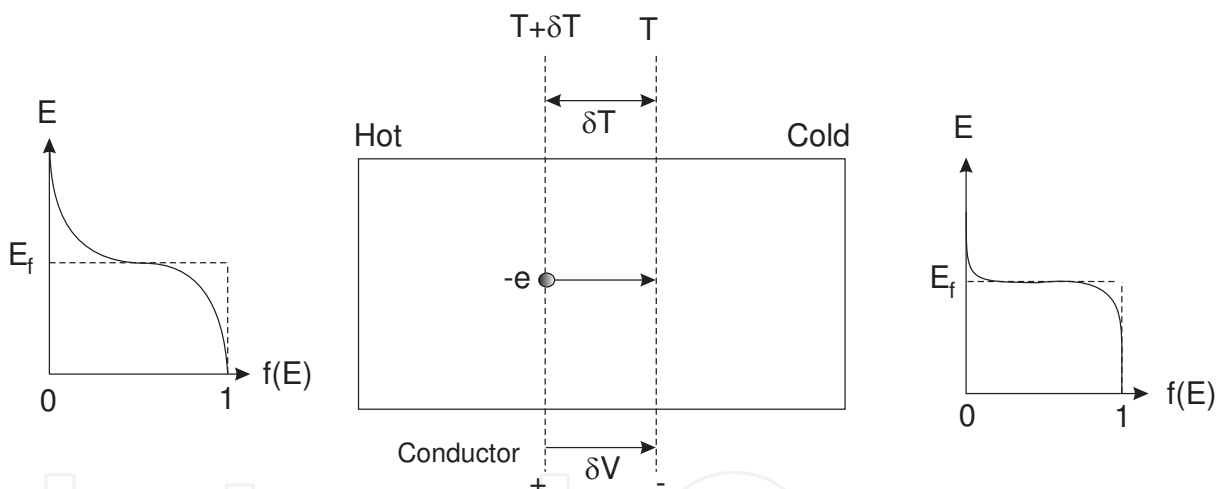

Fig. 2. Seebeck effect diagram.

Considering a small temperature difference δT produces a voltage δV between the accumulated electrons and exposed positive metal ions as it is shown in Fig. 2. For electrons diffusing from the hot region to the cold part, the system would work against the potential difference δV , i.e. $-e\delta V$, decreasing the average energy of the electron by δE_{av} , yielding

$$-e\delta V = E_{av}(T + \delta T) - E_{av}(T). \quad (6)$$

Using Eq. (5) in (6), and expanding $T + \delta T$, neglecting δT^2 term we obtain,

$$-e\delta V \approx \frac{\pi^2 k^2 T}{2E_{F0}}. \quad (7)$$

the Seebeck coefficient reads

$$S \approx -\frac{\pi^2 k^2 T}{2eE_{F0}}. \quad (8)$$

Table 1 shows typical experimental values for the Seebeck coefficient for several metals. Notice that some metals have positive S such as copper. The sign means that the electrons moves from cold to hot end of a copper rod.

Considering an aluminum rod heated at one end and cooled at the other end, the voltage difference reads

$$V_{AB} = \int_{T_0}^T (S_A - S_B) dT, \quad (9)$$

where S_A-S_B is the thermoelectric power for the thermoelectric couple given by both rods joined in a closed circuit. The voltage produced by the thermocouple pair depends on the metal used. Some conductor doped by the addition of impurities can produce deficiencies or an excess of electrons providing greater efficiency. The power extracted of the thermoelectric material is a function of its operating temperature. Elements with high enough thermal conductivity produce energy losses. Heat entering into the hot end would escape without much conversion to electricity. For a thermoelectric generator the thermoelectric rating, $Z = S^2/RK$, depends on the characteristic of the material, i.e. the voltage produced for the difference of temperature. Both R and K are electrical resistivity and thermal conductivity of the material, respectively. The thermoelectric generator will be more efficient with high Z values, i.e. high S , $1/R$ and $1/K$. Ordinary metals like copper are very good heat conductors.

| Metal | S at 0° C ($\mu\text{V K}^{-1}$) | S at 27° C ($\mu\text{V K}^{-1}$) | E_{F0} (eV) |
|-------|--------------------------------------|---------------------------------------|---------------|
| Al | -1.60 | -1.80 | 11.6 |
| Cu | 1.70 | 1.84 | 7.0 |
| Ag | 1.38 | 1.51 | 5.5 |
| Au | 1.79 | 1.94 | 5.5 |

Table 4. Seebeck coefficients for several metals.

4.1 Radioisotope thermoelectric generator

The typical static conversion system used in all outer planet mission is the well-known RTG (see Fig. 3), which is composed by a stack of 18 GPHS modules. The joined module GPHS-RTG, operates at normal voltage output of 28 V-dc. Both diameter and length of the RTG are 0.42 and 1.14 meters, respectively, and its weigh is about 55.9 kg.

The heat source assembly is surrounded by 572 silicon germanium (SiGe) thermocouples, known as unicouples. The unicouples are connected in two series-parallel electric wiring circuits providing the full output voltage. The induced magnetic field by the wires in the RTG is minimized, rearranging the electrical wiring (Abelson, 2004; Lange, 2008). The most recent use of a GPHS-RTG module was built for the New Horizons mission, launched in January 2006 to reach Pluto in 2015.

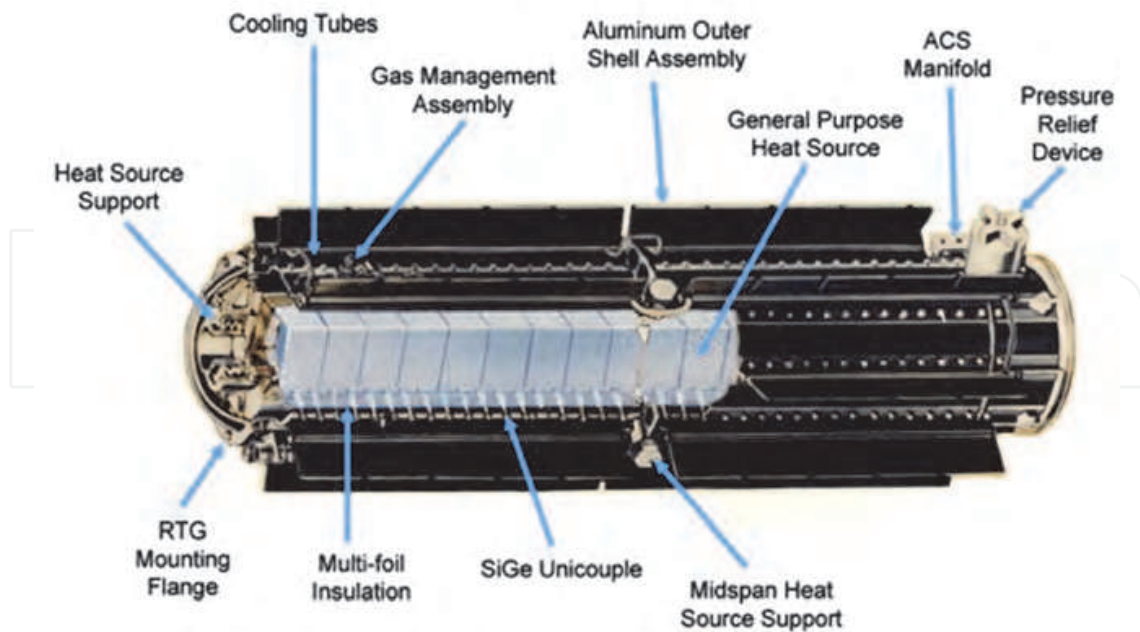

Fig. 3. Radioisotope Thermoelectric generator (RTG). (Source NASA/DOE/JPL)

4.2 Multi-mission radioisotope thermoelectric generator

The multi-mission radioisotope power generation (MMRTG) is the next generation of space RTGs (see Fig. 4). MMRTG is being developed by The Department of Energy (DOE) for planetary missions.

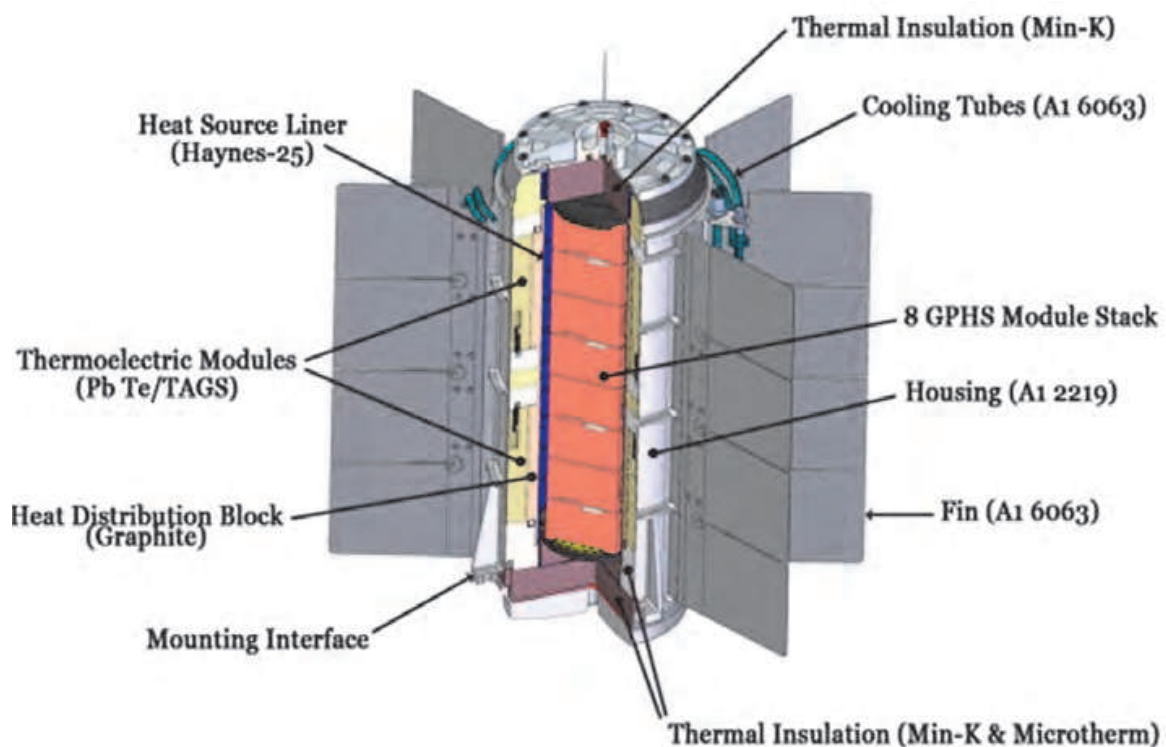

Fig. 4. Multi-mission Radioisotope Thermoelectric Generator (MMRTG). (Source NASA/DOE/JPL)

The MMRTG will generate 120 W of power at launch from a Pu-238 heat source assembly containing a stack of 8 Step 2 GPHS modules, which are described in section 3. The MMRTG operates at a normal output voltage of 28 V-dc. Both diameter and length of MMRTG are 64 cm diameter and 66 cm, respectively. The central heat source cavity is separated from the thermoelectric converter by a helium isolation liner. The helium generated by the Pu-238 is dumped to the environment by diffusion through an elastomeric gasket seal. The thermoelectric converter cavity can operate in both atmospheric environment or space vacuum (Ritz, 2004; Lange, 2008).

The thermocouples are connected in a series/parallel electrical circuit to improve the efficiency up to 6.8%. Waste heat is radiated from the eight radial fins. These fins are made of aluminum alloys coated with a high-emissivity to disintegrate and release the GPHS modules in the case of reentry into the Earth's atmosphere. The MMRTG is both lighter and smaller than RTG system.

5. Dynamic conversion energy

For dynamic systems the conversion mechanism consists on that the thermal energy is partially transformed into mechanical work, moving an alternator to produce electric power. Rankine, Brayton and Stirling systems use this conversion mechanism. Typical cycle diagram is shown in Fig. 5. The isotope heats an inert gas working fluid which is expanded through a turbine. The high-efficiency Brayton cycle is capable to recuperate part of the energy. The turbine discharge gas is cooled, first in the recuperator, then in the radiator. The resulting low pressure gas is passed through the compressor, compressed to the highest cycle pressure and heated at essentially constant pressure in the recuperator before being returned to the heat source. The recuperator recovers a significant amount of heat, which would otherwise be dissipated through the radiator resulting in a higher cycle efficiency (Abelson, 2004; Bennett, 2006; Lange, 2008).

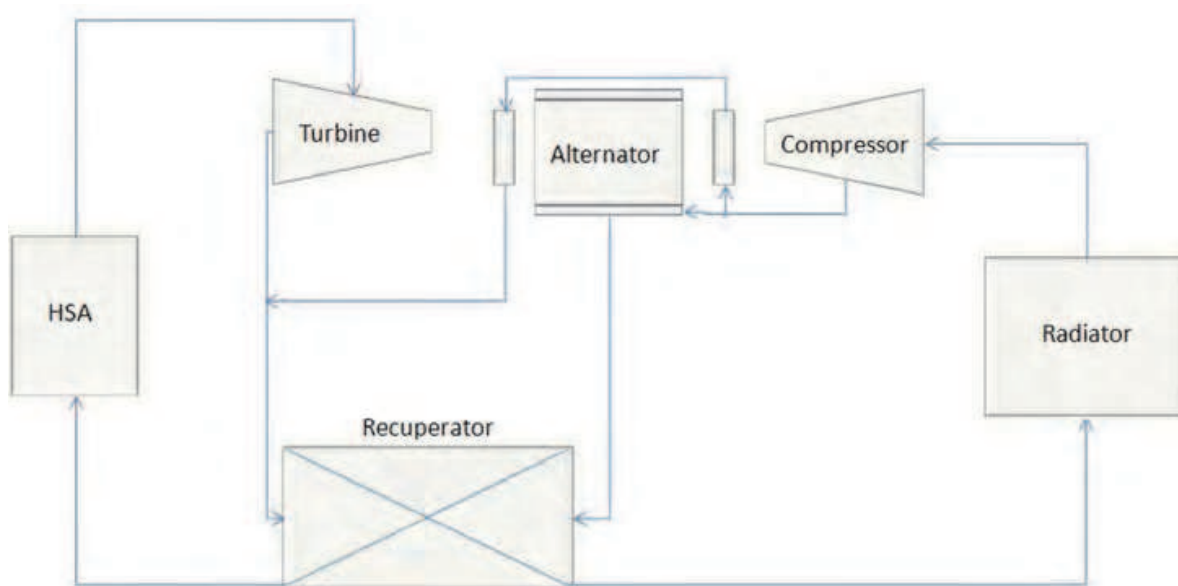

Fig. 5. Dynamic Isotope Power System Cycle

High efficiency in the RPS would both reduce system mass and fuel requirement, decreasing the total cost. Normally, RPS are tested at the ground in a vacuum chambers for a long time (>1000 hours). This would demonstrate that the design work also in the space with high power conversion efficiency.

Since the Brayton cycle is useless for power generation under 0.5 kW, missions with lower power requirement need an auxiliary electrical power generator.

The Stirling power system is based on a kinematics engine driving a three phase alternator. The initial design only worked during six months. It would not be appropriate for long-term missions. using a free piston combined with a linear alternator would be a promising technology for space power applications. The Stirling system, at difference of Brayton type, might provide low power. Further, Stirling engines operating in reverse have already used in space to provide cryogenic cooling for imaging sensors. The device has reciprocating pistons and displacers as it shown in Fig. 6. The motion of the components depends on physical springs or gas and on the cycle pressure swing of the engine. Typically, the engine contains only two moving parts.

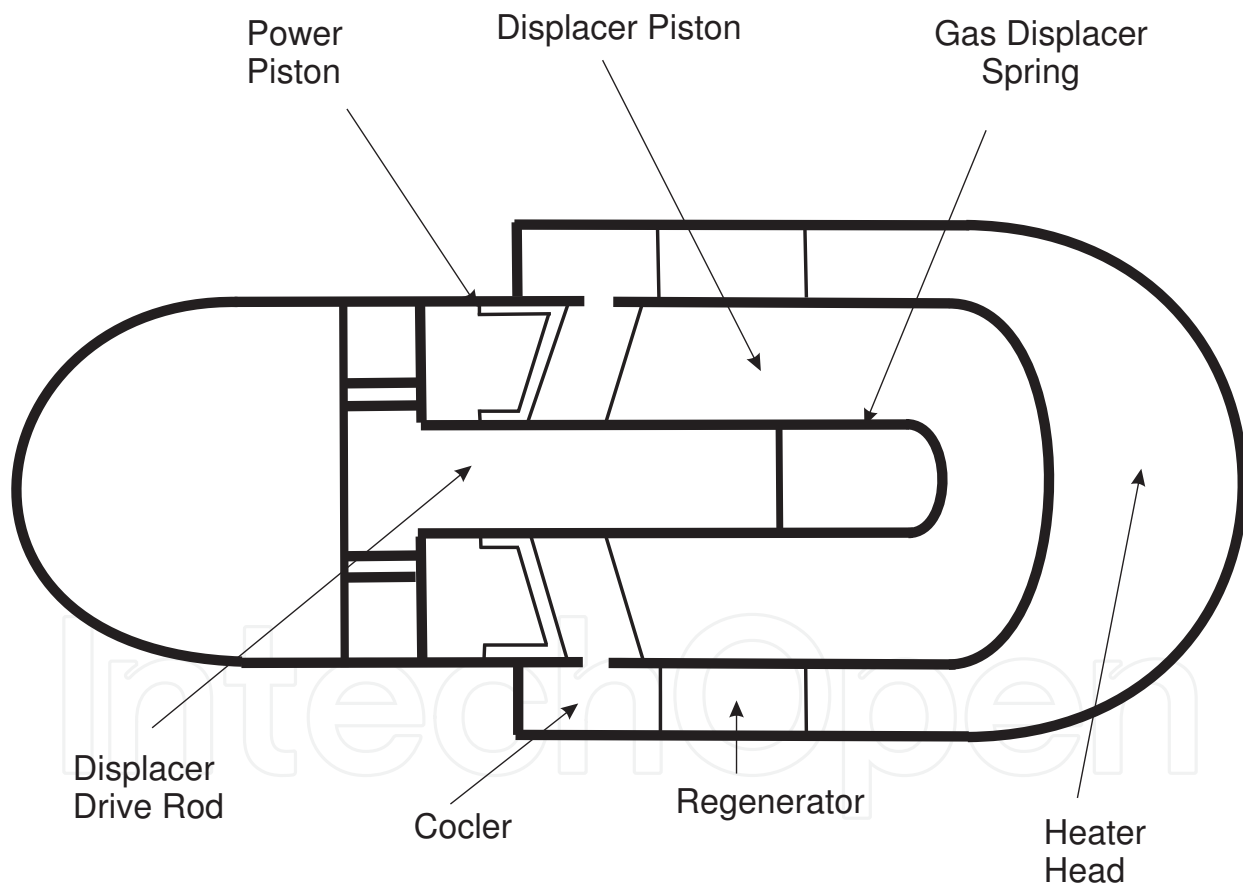

Fig. 6. Schematic diagram of the Stirling Isotope Power System

Two types of free pistons, linear alternator, Stirling machines are under development for mission in the range between 10 and 100 watts. The first type, under development by NASA. The power conversion efficiency for the Stirling producing 100 W is about 30%. The second type uses flexural spring to support the moving component to prevent friction and to provide enough axial springing for the free piston movement. The engine relies on the gap between the cylinder and the displacer to serve as regenerator for the system. As with

the Brayton cycle, heat regeneration is essential to achieve high efficiencies in Stirling engines. The design of a 10-W system has been tested, using fossil fuel combustion with a 20 % efficiency.

One of the problem of these systems is the attitude dynamic effects over the spacecraft. Both Brayton and Stirling systems have accumulated many time of testing. However, more tests would be required for outer planet missions that are expected to take more than 5 years.

6. RPS safety and accident evaluation

The Department of Energy (DOE) has worked to improve the safety of the RPS under all accident conditions, including accidents occurring near the launch pad and for orbital reentry accidents. The Pu-238 fuel for was changed from a metal to a more stable pressed oxide (PuO_2).

On April 21, 1964 the Transit-5-BN-3 mission was aborted because of a launch vehicle failure resulting in burn-up of the RTG during reentry, in keeping with the RTG design at the time. Some amount of the plutonium fuel was dropped in the upper atmosphere. The RTG design was changed to provide for survival of the fuel modules during orbital reentry.

A second accident occurred when the Nimbus B-1 was launched on May 18, 1968. It was aborted shortly after launch by a range destruction safety. The heat sources were recovered intact in about 90 meters under water in the California coast without release of plutonium. The fuel capsules were reworked and the fuel was used in a later mission (Abelson, 2004; Furlog, 1999).

The third incident occurred in April 1970, when the Apollo 13 mission to the moon was aborted following an oxygen tank explosion in the spacecraft service module. Upon return to Earth, the Apollo 13 lunar excursion module with a SNAP-27 RTG on board reentered the atmosphere and broke up above the south Pacific Ocean. The heat source module fell into the ocean. Atmospheric and oceanic monitoring showed no evidence of release of nuclear fuel.

The ceramic form covering plutonium-238 dioxide is heat-resistant and limits the rate of vaporization in fire or reentry conditions. The material also has low solubility in water. This material does not disperse though the environment.

More than 35 years have been researched in the engineering concepts and testing of RPS systems. Multiple layers of protective materials, including iridium capsules (or platinum-shodium capsules for RHUs) and high strength, heat-resistant graphite blocks are used to protect the radionuclide and prevent its release. Iridium is a strong, corrosion-resistant metal that is chemically compatible with plutonium dioxide. In addition, graphite is used because it is lightweight and highly heat-resistant. Several test for potential accident scenarios to know how RTG responses has been developed. Results of the failure mechanisms provide the basis for the determination of the source terms which are the characterization of plutonium releases including their quantity, location and particle size distribution. Recent large fragment tests in the GPHS safety test program have demonstrated in Solid Rocket Boosters (SRB) accident case, fragments impacting the full RTG system will not breach the fueled clads at velocities up to 0.12 km/s.

The multi-layer containment concept employed for the systems is designed to contain the radioisotope but even if the containment is breached, the ceramic pellet has been designed to limit dispersal of the material into the environment.

Several accidents can occur in a space missions. Typical phases for deep space exploration missions (interplanetary mission) consists on: phase 1, called as ascent, begins with liftoff of the Space Shuttle vehicle from launch pad, and then continues until the Solid Rocket Boosters are jettisoned some time after; phase 2, Second stage. This phase includes the first burn of the Orbital Maneuvering System (OMS) engines. The Shuttle main engine cutoff is included in this phase; phase 3, on Orbit, starting with the first burn of the OMS (OMS-1) and ends when the payload are deployed from the Orbiter. The phase include the first and second burns of the OMS (OMS-1 and OMS-2) for following the correct orbit and circularization; phase 4, Payload deploy, when reach the Earth escape velocity; phase 5, Maneuvers. To make possible some outer missions, is needed Gravitational Assist Maneuver, to obtain an impulse on the Spacecraft using the rotation energy of the planet. Critical issue is an Earth Gravity Assist, because the SC come back to the Earth; and a possible reentry (phase 6), exclusively for missions which ends with an spacecraft on an Earth reentry.

Various consequences could result from the accident environments that have been defined for the safety evaluation in the Final Safety Analysis Report (FSAR). In phase 1, the possible accidents resulting from Solid Rocket Booster (SRB) failures, either self induced or resulting from Range Safety destruct, can in certain instances lead to damaged GPHS modules with subsequent release of fuel due to: impact by SBR case fragments and subsequent impact against ground surfaces or launch pad structures. In phase 2, vehicle breakup resulting from orbiter failures can result in reentry of the RTG and breakup of the GPHS modules on hard ground surfaces. In both phases 3 and 4, Shuttle failures can result in reentry of the SC (and RTGs) with subsequent breakup and release of the GPHS modules to impact on ground surfaces. In the case of the spacecraft should fail to reach escape velocity it would reenter into the Earth atmosphere. The heat of reentry would release the heat source from the generator and allow it to impact to the ground. The capsule would be exposed to reentry heating, Earth impact, and oxidation. If the heat shield were to fail, the unprotected capsule could fail in reentry and expose the bare fuel disks to the reentry and impact conditions (JPL, 1994; Richins, 2007). Additionally, in an Earth gravitational maneuver scenario, SC might reenter at very high velocity due to a spacecraft failure or a mission failure, such as puncture of the SC propellant tank by a micrometeoroid (space debris).

7. RTGs versus solar arrays

In regions on the space near Sun, NASA has historically used a few solar electric power systems such as solar panels. Several mission such as Mars Observer, the Viking Orbiters and Mariners missions were solar powered missions. For improving the systems efficiency, the Mars Global Surveyor used solar power with gallium-arsenide cells (JPL, 1994).

For outer planet missions, NASA has used radioisotope thermoelectric generators for the Cassini spacecraft. High electrical power for mission science requirements in powering the instruments and communication systems makes the RTG systems better option than solar arrays. The low efficiency of the solar cells for distances beyond Jupiter is an important drawback. Further, the spacecraft must be as lighter as possible. The size of the theoretical arrays of solar panels to obtain the power required for all sciences systems would be very large, increasing the spacecraft mass.

As regards on the solar cell technology, the actual production efficiencies of advanced solar cells have historically lower than research findings. The high-efficiency ESA solar cell

devices are relative thick and heavy compared to the usual solar cells. Further, these advanced cells would be radiation sensitive. Solar-powered Juno mission will be launched in August on 2011, to study Jupiter. The spacecraft avoid the intense radiation belts using a innovative polar orbit, obtaining a great visibility for both the solar light arriving from the sun and communications.

Large solar arrays would severely impact the design, mass and operation of the spacecraft. This structure would have to be deployable, i.e. it could fit inside the rocket payload, and then unfold once the SC reached the outer planet. The mechanical components to fold and unfold the arrays would increase notably the size and mass on the SC. The long solar arrays would also severely complicate the stability on the trajectory and the attitude for scientific observations and data transmission to the Earth. Large spacecraft size, indeed, would make the maneuvers slower, which is critical for scientific data collection.

The electrical power requirements of the spacecraft for science instruments and telecommunications, launch mass, and mission lifetime are all of critical concern in choosing the electrical power source.

8. Conclusion

In space application, Radioisotope Power Systems takes some advantages over solar panels. In several space operations there are long periods of darkness, and RPS will be the best actual technology. For outer planet missions, RTGs are more useful than solar panels to generate electric power for feeding communication systems and scientific instruments on the spacecraft. Additionally, there are new space technologies that use natural resources with/without radioisotope power systems. Future mission such as Europa Jupiter System Mission (EJSM), which is a joined NASA/ESA mission, will intend to study Jovian system, focusing two particular Jovian moons. NASA-led will use one type of RPS on Jupiter Europa Orbiter (JEO) to reach Europa, whereas ESA will consider solar arrays for Ganymede exploration. NASA's Juno mission will use solar panels for Jovian system exploration, in spite of the low solar light reaching Jupiter. The JEO spacecraft is designed to meet the planetary protection requirements. The flight system will use five multi-mission RTGs (MMRTG) to generate ~ 540 W of electrical power at the end of the mission. The high radiation environment (>50 the dose supported of Juno mission) makes the RPS more useful than solar array, because of the low solar wind reaching Jupiter. Waste heat from the MMRTGs would be used for thermal control in order to reduce electrical power.

Safety analysis of RPS requires a combination of deterministic and probabilistic steps to accurately predict the probability of system failure. The system failure is defined as rupture of one or more of the internal containment capsules surrounding the radioisotope fuel. To reduce the accident probability, we would have to identify among credible accidents, and analyze typical accident scenarios and consequences for overall flight phases of the spacecraft. The Launch Accident Scenario Evaluation Program (LASEP) computer program analyze the overall response of the GPHS-RTG in the various on-pad and near-pad launch accidents.

Actual high-magnitude earthquakes events occurred in Japan in 2011, has severally damaged the Fukushima reactor. This marks the difficult to change the public opinion about nuclear energy. Besides, the low disposal of Plutonium-238 is a serious drawback. The reestablishment of this man-made radioisotope production will be more difficult with these

events. For using less plutonium than required, RPS efficiency must improve. Using low-conductivity materials and high thermoelectric rating, Z , RPS efficiency would improve. A high-efficiency Stirling-type system would give an apparent mass/power benefit, as well as using less plutonium for a similar power output. If we want to continue using RPS with Plutonium-238 as fuelling, we have to develop more high-efficiency systems, avoiding vibrations on the attitude on the spacecraft, as itself occurs with dynamic-conversion system. The current RPS power conversion efficiency is not too high. It is also required lower cost power systems.

Tethers might be used as alternative to solve the severe power generation problem. An electrodynamic tether, which is a very long wire capable to generate the suggested power, might radiate waves to satisfy communication requirements itself (Sanchez-Torres et al., 2010). The large electromotive force produced by the tether moving in some plasma ambient near the planet generate induced current and then electric power (Sanmartin et al., 1993). Tethers might be very useful for generating electric power both in Low Earth Orbit (high plasma density and moderate magnetic field) and in Jovian conditions (low plasma density and high magnetic field).

9. Acknowledgment

This work was supported by the Ministry of Science and Innovation of Spain (BES-2009-013319 FPI Grant).

10. References

- Abelson, R. et al. (2004). Enabling Exploration with Small Radioisotope Power Systems, *JPL Pub 04-10*, Available from <http://hdl.handle.net/2014/40856>
- Bennett, G. et al. (June 2006). Mission of Daring: The General-Purpose Heat Source Radioisotope Thermoelectric Generator, *4th International Energy Conversion Engineering Conference and Exhibit*, San Diego, California, Available from <http://www.fas.org/nuke/space/gphs.pdf>
- Brown, C. (2001). Elements of Spacecraft Design, *AIAA Education Series*, Reston, Virginia, ISBN 1-56347-524-3
- Furlog, R. & Wahlquist, E. (1999). U.S. Space Missions Using Radioisotope Power Systems, *Nuclear News*, pp. 26-34, Available from <http://www.ans.org/pubs/magazines/nn/pdfs/1999-4-2.pdf>
- Griffin, M. & French, J. (2004). Space Vehicle Design, Second Edition, *AIAA Education Series*, Reston, Virginia, ISBN 1-56347-539-1
- Hastings, D. & Garrett, H. (2004). Spacecraft-Environment Interactions, *Cambridge University Press*, Cambridge, UK, ISBN 0 521 60756 6
- JPL (July 1994). Cassini Program Environmental Impact Statement Supporting Study. Volume 2: Alternate Mission and Power Study, *JPL Publication No. D-11777. Cassini Document No. 699-070-2*, Available from <http://saturn.jpl.nasa.gov/spacecraft/safety/eisss2.pdf>
- Lange, R. & Carrol, W. (2008). Review of Recent Advances of Radioisotope Power Systems, *Energy Conversion and Management*, 49, pp. 393-401, ISSN: 0196-8904

- National Research Council. Aeronautics and Space Engineering Board, Space Studies Board, Engineering and Physical Sciences (2009), *Radioisotope Power Systems: An Imperative for Maintaining US Leadership in Space Exploration, Tech. Rep.*, The National Academic Press, Washington, D.C. , Available from <http://www.nap.edu/catalog/12653.html>
- Richins, W. & Lcay, J. (June 2007). Safety Analysis for a Radioisotope Stirling Generator, *Proceedings of Space Nuclear Conference, Paper 2024*, Available from <http://georgenet.net/misc/rtg/Safety%20Analysis%20for%20RTG.pdf>
- Ritz, F. & Peterson, G. (2004). Multi-Mission Radioisotope Thermoelectric Generator (MMRTG) Program Overview, pp. 2950-2957, *IEEE Aerospace Conference Proceedings*, ISSN: 1095-323X
- Sanchez-Torres, A.; Sanmartin, J., Donoso, J., Charro, M. (2010). The radiation impedance of electrodynamic tethers in a polar Jovian orbit, *Advances in Space Reseach*, Vol. 45, pp. 1050-1057. ISSN: 0273-1177
- Sanmartin, J.; Martinez-Sanchez, M., Ahedo, E. (19930). Bare Wire Anode for Electrodynamic Tethers, *J. of Propulsion and Power*, Vol 9, pp. 353-360, ISSN: 0748-4658
- Sturgis, B. et al. (September 2006). Methodology Assessment and Recommandations for the Mars Science Laboratory Launch Safety Analysis, *Sandia Report Sand 2006-4563*. DOI: 10.2172/893553.

IntechOpen

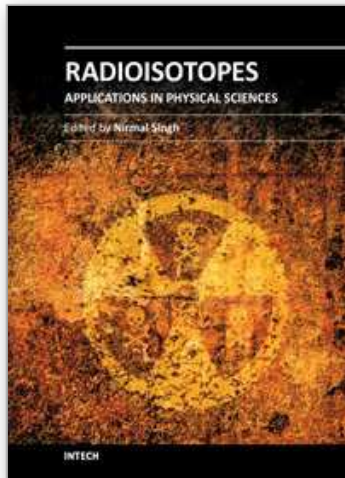

Radioisotopes - Applications in Physical Sciences

Edited by Prof. Nirmal Singh

ISBN 978-953-307-510-5

Hard cover, 496 pages

Publisher InTech

Published online 19, October, 2011

Published in print edition October, 2011

The book *Radioisotopes - Applications in Physical Sciences* is divided into three sections namely: Radioisotopes and Some Physical Aspects, Radioisotopes in Environment and Radioisotopes in Power System Space Applications. Section I contains nine chapters on radioisotopes and production and their various applications in some physical and chemical processes. In Section II, ten chapters on the applications of radioisotopes in environment have been added. The interesting articles related to soil, water, environmental dosimetry/tracer and composition analyzer etc. are worth reading. Section III has three chapters on the use of radioisotopes in power systems which generate electrical power by converting heat released from the nuclear decay of radioactive isotopes. The system has to be flown in space for space exploration and radioisotopes can be a good alternative for heat-to-electrical energy conversion. The reader will very much benefit from the chapters presented in this section.

How to reference

In order to correctly reference this scholarly work, feel free to copy and paste the following:

Antonio Sanchez-Torres (2011). Radioisotope Power Systems for Space Applications, *Radioisotopes - Applications in Physical Sciences*, Prof. Nirmal Singh (Ed.), ISBN: 978-953-307-510-5, InTech, Available from: <http://www.intechopen.com/books/radioisotopes-applications-in-physical-sciences/radioisotope-power-systems-for-space-applications>

INTECH
open science | open minds

InTech Europe

University Campus STeP Ri
Slavka Krautzeka 83/A
51000 Rijeka, Croatia
Phone: +385 (51) 770 447
Fax: +385 (51) 686 166
www.intechopen.com

InTech China

Unit 405, Office Block, Hotel Equatorial Shanghai
No.65, Yan An Road (West), Shanghai, 200040, China
中国上海市延安西路65号上海国际贵都大饭店办公楼405单元
Phone: +86-21-62489820
Fax: +86-21-62489821

© 2011 The Author(s). Licensee IntechOpen. This is an open access article distributed under the terms of the [Creative Commons Attribution 3.0 License](#), which permits unrestricted use, distribution, and reproduction in any medium, provided the original work is properly cited.

IntechOpen

IntechOpen