

# We are IntechOpen, the world's leading publisher of Open Access books Built by scientists, for scientists

5,300

Open access books available

132,000

International authors and editors

160M

Downloads

Our authors are among the

154

Countries delivered to

TOP 1%

most cited scientists

12.2%

Contributors from top 500 universities



WEB OF SCIENCE™

Selection of our books indexed in the Book Citation Index  
in Web of Science™ Core Collection (BKCI)

Interested in publishing with us?  
Contact [book.department@intechopen.com](mailto:book.department@intechopen.com)

Numbers displayed above are based on latest data collected.  
For more information visit [www.intechopen.com](http://www.intechopen.com)



# The Potential of Flow-Based Optosensing Devices for Pesticide Assessment

Maria Luisa Fernández-de Córdoba and Pilar Ortega-Barrales  
*University of Jaén  
Spain*

## 1. Introduction

The rise of intensive agriculture in the last decades has originated the massive use of pesticides (herbicides, fungicides or insecticides), which has become a serious environmental problem and a potential risk for human health. Pesticides residues can be often found in soils, natural waters, atmosphere and agricultural products and cause adverse effects on humans, plants, animals and ecosystems, even at low concentration levels. In order to guarantee consumer safety and regulate international trade, Maximum Residue Limits (MRLs) for pesticides in foodstuffs have been established by several Government agencies and European Union Commission (European Union, 2005).

Therefore, nowadays the development of new analytical methodologies capable of determining trace levels of pesticides in the environment is one of the most important tasks in analytical science. The determination of pesticide residues in food matrices is a formidable challenge mainly because of the small quantities of analytes and large amounts of interfering substances which can be co-extracted with them and, in most cases, adversely affect the results of an analysis (Wilkowska & Biziuk, 2011). Pesticide analysis in food samples has been usually carried out by means of multi-residue methods that use gas chromatography (GC) as the preferred technique because many of these compounds are low polar, volatile and thermally stable (Guan et al., 2010; Hunter et al., 2010). Nevertheless, new pesticides, which show a more specific mode of action and have a higher polarity and lower persistence than old ones, have been developed in the last years. Most of these novel compounds can be conveniently separated by high-performance liquid chromatography (HPLC) (Fu et al., 2009; Soler et al., 2008; Wu et al., 2002). Currently, pesticides comprise more than 1200 active ingredients, which are formulated in thousand of different commercial products (Ahmed, 2001). Since they present very different physic-chemical characteristics and large differences in volatility, polarity and persistence, both GC and HPLC coupled to mass spectrometry detection (GC-MS, HPLC-MS) are used as complementary techniques in pesticide analysis (Garrido et al., 2005; Pang et al., 2006).

Nevertheless, although pesticide residue analysis methodologies in different matrices by GC and/or HPLC are well established, there is still a need for sensitive, faster, easy-to-use and cost effective procedures as real and practical alternatives to the robust and efficient chromatographic methods. These procedures would allow the rapid detection of pesticides, being used for a preliminary screening in laboratories where a large number of samples have to be processed in a short time. In response to this need, several spectroscopic

methods, based on the use of a solid phase, have been developed in the last years, due to their inherent features as selectivity, sensitivity and low cost of analysis. This methodology, called solid-phase spectrometry (SPS) (Matsuoka & Yoshimura, 2010), can be performed in batch mode (M.L. Fernández et al., 1998; Richter et al., 2002) or in automatic mode (López et al., 2007a; Traviesa et al., 2004). In both of them, the species of interest (analyte or a derivate) is retained on an appropriate solid support and the direct measurement of the light absorption or emission of this latter is carried out. Sensitivity and selectivity are the two most remarkable analytical features of this methodology. This is due to the separation of the species of interest from the sample matrix and its preconcentration on the solid support, that is, in the zone itself where it will be measured with a non-destructive molecular spectroscopic detector.

The combination of SPS with flow-injection analysis (FIA), the so called flow-through optosensors (Ruzicka & Hansen, 1985), combines the advantages of both methodologies, simplicity, rapidity, sensitivity, selectivity and low cost. In this kind of systems the separation and retention of the species of interest on the solid phase take place in the detection area itself and simultaneously with it. Therefore, these systems integrate, in the space and time, several analytical processes, separation, preconcentration and detection. It is necessary to clarify that flow-through optosensors combine flow-injection techniques with detection on an optically active surface packed in a flow-cell and, consequently, the analytical signal is measured directly on the solid support. Nevertheless, flow systems using a solid support which is not packed into a flow-cell have also been reported for the determination of pesticides. They are usually based on the use of a biological recognition element which is immobilized on a solid support placed into an immunoreactor (biosensors), and the measurement is carried out in solution after the elution of the monitored species from the solid surface. Sometimes, they are also called flow-through optosensors in literature although, according to the first definition of these systems (Ruzicka & Hansen, 1985), this denomination is not appropriate. They will be also reviewed here, but in a minor depth than flow-through optosensors.

## 2. Flow methodologies in optosensors

The basic components of any flow system include: propelling unit, device/s for the introduction of solutions into the system, flow-through cell and detector. To date, four different flow methodologies have been used in the development of optosensors for the determination of pesticides, which will be here described (Table 1).

### 2.1 Flow-injection analysis (FIA)

A FIA system includes a peristaltic pump to propel the solutions, a series of plastic tubes to transport them, injection valves to introduce constant volumes of the solutions in the system, a flow-cell and the detector. The valves usually employed are six-way rotary valves, which are manually-controlled and allow the insertion of a defined volume of solution in the system. The main advantages of a conventional FIA system are high throughput, repeatability, versatility and automation. This was the first flow methodology used in the development of optosensors for the analysis of pesticides (Agudo et al., 1993) and the most frequently used one in flow-based biosensors (Roda et al., 1994; Varsamis et al., 2008) and chemical optosensors (Badía & Díaz, 1999; Piccirilli & Escandar, 2009).

## 2.2 Sequential-injection analysis (SIA)

SIA was introduced as a following generation in the development of FIA, with the aim of improving automation and versatility of FIA systems. The key components of a SIA manifold are a multi-position valve and a bi-directional syringe pump (both automatically controlled by a computer). Sample and reagents are introduced in a holding coil before being impelled by the piston of the pump through a mixing coil to the detector. The multi-position valve avoids the use of additional valves, such as in conventional FIA systems, in which several valves are needed. The great advantages of this technique are an important saving in samples and reagents, robustness and versatility, whereas a lower analysis rate and complicated software are the main drawbacks. To date, SIA has been applied only to the development of immunosensors in pesticide assessment (González et al., 2005; Herranz et al., 2008).

## 2.3 Multicommutation flow-injection analysis (MCFIA)

In MCFIA the sample injector used in FIA is replaced by three-way solenoid commutation valves. Each solenoid valve acts as an independent switch and the whole system is automatically controlled by a computer. These valves are similar to an electronic circuit, with a variable number of active nodes, and present two different positions: "ON" and "OFF", allowing the effective control of sample and reagents dispersion and widening the scope of applications in flow analysis. Compared to conventional FIA, the injected volume can also be adjusted by controlling the commutation timing via software. Hence, the high repeatability in multicommutation systems is associated with the precision in time measurement. In addition, as sample and reagents are injected into the flow system only when necessary, the consumption rate and waste generation can be minimized. Recently, several MCFIA fluorescent chemical optosensors have been proposed (Llorent et al., 2007; López et al., 2007a) for determination of pesticides.

## 2.4 Multi-syringe flow-injection analysis (MSFIA)

This technique is based on the use of multiple syringes which are used as liquid-propelling devices. The variety of available syringes with very different capacities offers a broad selection of flow rates. The implementation of three-way solenoid valves at the head of every syringe allows the injection of precise and well-defined volumes of sample and reagents. MSFIA was introduced as an alternative to its predecessor techniques, combining manifold operation and high sample throughput of FIA together with the robustness and versatility of SIA. Peristaltic pumps are still the most common liquid-propelling drives in FIA and MCFIA. In these systems, the flexible Tygon tubing of the pumps needs to be replaced periodically. Nevertheless, the pump tubing lifetime can be eliminated in MSFIA. In addition, reagent consumption is reduced by more than 10 times in comparison with common flow injection procedures. To date, only a flow-based optosensor using MSFIA has been proposed. The system allowed the determination of one of the main degradation products of pesticides derived from naphthalene acid, 1-naphthylamine (Guzmán et al., 2006).

The introduction of SIA, MCFIA and MSFIA has provided an additional grade of automation, when comparing to FIA, due to a complete absence of human intervention during each measurement. This is due to the automatic control of the flow of solutions. In addition, it has allowed the reduction of the reagents and sample consumption, which makes these methodologies to be more suitable for routine analysis.

Flow methodology	Propulsion unit	Injection unit	Other elements
FIA	Peristaltic pump	Six-way rotary valves	-
SIA	Bidirectional syringe pump	Multi-position valves	Holding coil
MCFIA	Peristaltic pump	Computer controlled three-way solenoid valves	-
MSFIA	Multisyringe module	Computer controlled three-way solenoid valves	Holding coil. Reaction coil

Table 1. Flow methodologies used in optosensors for determination of pesticides

### 3. Chemical flow-based optosensors

A large number of optical chemical sensors based on light absorption or emission detection has been presented over the past 20 years for pesticide assessment. Next, the main characteristics and applications of these systems are reviewed.

#### 3.1 Solid supports

The purpose of the solid support in flow-based optosensors is the retention of the analyte or a product generated from this latter and, consequently, its preconcentration and separation of the sample solution on a very little amount of it. Therefore, its selection mainly depends on the nature of the target species. For the selection of an appropriate solid support, it is necessary to take into account that it has to satisfy some requirements such as: (a) to be compatible with the detection system used, that is, to provide an appropriate background signal; (b) the particle size has to be large enough to avoid overpressure in the system; (c) to guarantee reproducibility in the response of the sensor; and (d) the retention/elution process of the species of interest has to be quick enough. The solid support is usually packed into a commercial flow-cell that is placed in the detection area. Sometimes, in the case of the simultaneous determination of two or three analytes or the removal of a potential interfering species, solid supports are packed into little minicolumns inserted on-line in the flow injection system.

The most frequently used solid support in flow-based optosensors for pesticides analysis has been C<sub>18</sub> bonded silica gel, an adsorptive hydrophobic material, which is very appropriate for neutral species that show low solubility in water (Llorent et al., 2007; López et al., 2009a). Nevertheless, this sensing material presents an important drawback to take into account, its low selectivity because of the adsorptive nature of the retention process. Although usually this solid support has been used for filling a commercial flow-cell, a recent application proposed its use in form of extraction disks (Guzmán et al., 2006). The C<sub>18</sub> extraction disks present some advantages over conventional resins, such as higher flow rates, low overpressures and better reproducibility. When using these extraction disks the detection is carried out by measuring the intensity of reflected incident light at the surface of the disk with a bifurcated optical fiber.

Polystyrene-type and gel-type ion exchangers have also been used for the retention of charged species. The first ones, constituted by a hydrophobic aromatic matrix, are usually discarded when working in UV region because of their very high background but they can

be used for Visible measurements. As an example, the use of a Dowex 50W-X8-200 cation-exchange resin for the retention of paraquat and its posterior reaction with a chromogenic reagent (Agudo et al., 1993) can be cited. With respect to gel-type exchangers, dextran polymers such as Sephadex resins have been the most widely used. Their ionic character allows the exclusion of a lot of compounds accompanying to analyte in samples. It is worth of mentioning the use of Sephadex QAE A-25 for the analysis of azoxystrobin in grapes, wine and must (López et al., 2007a). The use of this anionic sensing material allowed a high tolerance of the proposed method to the presence of other fluorescent pesticides such as carbofuran, imazalil, carbaryl and bendiocarb.

Non-ionic resins, known like macroporous polymers, have also been used sometimes, although their high background in the UV and Visible regions make them useful only for luminescence measurements. This is the case of Amberlite XAD 7 resin which was used for the phosphorimetric determination of naptalam (Salinas et al., 2004).

On the other hand, a fluorescent optosensor has been proposed for the determination of warfarin based on the use of a  $\beta$ -cyclodextrin bonded (Cyclobond I) as sensing support (Badía & Díaz, 1999). Cyclodextrins are macrocyclic glucose oligomers in which the oligosaccharide ring forms a torus, whose outer surface has a hydrophilic character; on the contrary, the inner cavity is hydrophobic. The interest of these materials comes from their ability to bind a variety of guest molecules inside the non-polar cavity. Warfarin could be determined in waters without any previous treatment with a detection limit of  $2 \mu\text{g L}^{-1}$ .

Recently, the use of nylon powder as a new sensing material has been investigated for the determination of thiabendazole (Piccirilli & Escandar, 2007, 2009). This material is obtained by scratching 6,6-nylon probes and sieving the resulting powder through a stainless steel strainer. Although nylon particles have heterogeneous shapes, they allow reproducible analytical signals and show good mechanical and chemical resistance. The application of this new material to the fluorescent analysis of thiabendazole (Piccirilli & Escandar, 2007) did not show any advantages when comparing to the use of other adsorbents such as  $\text{C}_{18}$  silica gel. Nevertheless, the immobilization of this fungicide on nylon powder was sufficiently efficient as to allow its phosphorescence emission and develop for the first time a phosphorimetric flow-based optosensor (Piccirilli & Escandar, 2009). A significant improvement in selectivity of thiabendazole determination was obtained, avoiding the interference originated by others fluorescent pesticides such as carbaryl, carbendazim or 1-naphthylacetic acid.

A very recent way to achieve the tailored selectivity of analytes is the use of molecularly imprinted polymers (MIPs). Molecular imprinting is usually a process of copolymerization of functional and cross-linking monomers in the presence of a template molecule. The removal of the template molecules leaves a predetermined arrangement of ligands and a tailored binding pocket (Alexander et al., 2006). Such imprinted polymers show an affinity for the template molecules over other structurally related compounds. MIPs are successful to enhance the selectivity of a luminescence optosensing system and they are considered as one of the simplest, most straightforward and cost-effective methods for developing artificial receptors for toxic organic species. The implementation of MIPs in a flow-based optosensor for analysis of pesticides was described for the first time for the sensing of two monoamine naphthalene compounds (MA-NCs), 1-naphthylamine (1-NA) and 2-naphthylamine (2-NA), considered as priority contaminants. The measurement of the room-temperature fluorescence emission of every one of them, at their respective optimal excitation and emission wavelengths and at an isoemissive point, allowed their individual and total (NA) determination, respectively (Valero

et al., 2009a), in drinking waters. Nevertheless, the interference of 1-naphthalenemethylamine (1-NMA), which was also adsorbed on these MIPs, was serious and could not be avoided. On the other hand, there was no interference of 1-naphtol and 2-naphtol, both considered as the most important potential interfering species. Later, the same authors developed a very similar MIP fluorescence optosensor for the simultaneous determination of 1-NA and 2-NA in the presence of 1-NMA without sample pre-treatment. The determination was possible by processing fluorescence data with multivariate calibration (Valero et al., 2009b).

The use of MIPs as recognition elements in chemiluminescence sensors is another promising approach for the improvement of both sensitivity and selectivity. In addition, the template molecules adsorbed can be destroyed through the chemiluminescence reaction, and the templates that have been reacted can be easily washed off using water as eluent, so avoiding the use of buffer solutions or organic solvents for MIPs regeneration purposes (Fang et al., 2009).

### 3.2 Flow-cells

Two aims have to be pursued in the choice of an appropriate flow-cell for the development of an optosensor. On the one hand, the target species has to be retained in an area of the solid support as small as possible, in order to obtain its highest preconcentration in the detection area and, consequently, the highest sensitivity. On the other hand, the light beam of the detector must be focused on this area without loss of light to the surrounding zones. In addition, it is necessary to take into account that the light path can not be too long since it would originate a high background signal of the solid support, which would be incompatible with the measurement.

The most appropriate commercial flow-cells for the development of flow-based optosensors are Hellma 138-OS (Fernández et al., 1991) and Hellma 176.052-QS (López et al., 2007b; Piccirilli & Escandar, 2009), for absorption and emission measurements, respectively (Figure 1). The cells are blocked in the outlet with glass wool to prevent the particle displacement by the carrier stream. Then, the solid support, as a slurry suspension, is loaded with the aid of a syringe and the inlet is kept free. The packing level of solid support in the flow cell is a key variable. It has to be filled just up to a height which enables the light beam to pass completely through the solid layer. If the solid support does not reach the optical path, the

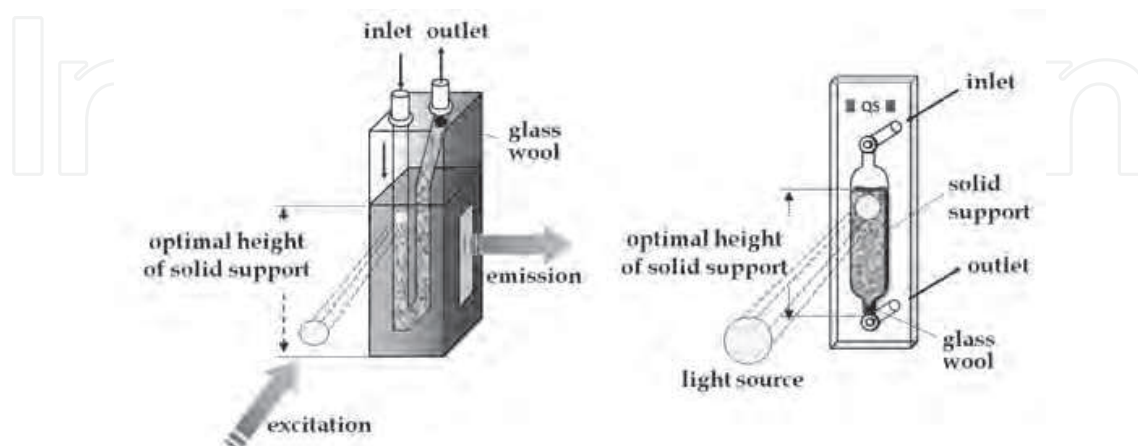

Fig. 1. Flow-cells used in chemical optosensors. (a) fluorescence and phosphorescence measurements: Hellma 176.052-QS, 25  $\mu\text{L}$  inner volume, 1,5 mm optical path; (b) absorbance measurements: Hellma 138-OS, 50  $\mu\text{L}$  inner volume, 1 mm optical path.

light beam passes through the solution and, consequently, a decrease in the signal is obtained. If the packing top is far above the light beam, the support area with the highest concentration of the retained species of interest would fall outside the irradiated area and so, a lower and wider signal would be obtained. Therefore, the top of the support has to be kept as close as possible to the light beam, so resulting in higher sensitivity.

A piece of V-shape colourless glass tube (5 mm x 5 cm i.d. length) has been also used for packing the solid support when using chemiluminescence detection (Fang et al., 2009). After stuffing both ends of the tube with glass wool, it was connected to the flow system and placed just in front of the photomultiplier.

In the case of using optical fiber reflectance for detection, the solid support is placed just at the end of the fiber by using home-made devices (Guzmán et al., 2006).

### 3.3 Regeneration of solid support

A very important and key requirement of flow-based optosensors is the successive reutilization of the solid support placed into the flow-cell for a large number of measurements, which makes them reusable. It involves the regeneration of the solid support after every injection of sample solution and analytical measurement, which can be achieved in two different ways (Figure 2): (a) the carrier solution itself acts as eluting solution, so desorbing the species monitored from the solid support after every injection of sample. This is the simplest procedure to regenerate the solid support since it is not necessary the use of an additional eluting solution. Although this procedure allows a high throughput, the transitory retention of the target species in the detection area also originates a decrease in the analytical signal obtained; (b) after every injection of sample, an eluting solution is passed through the sensing zone in order to remove the species retained on it. This is necessary when the species monitored is permanently retained on the solid support or its elution from this latter by the carrier solution itself is very slow. Sensitivity achieved is higher than in the previous case, but the use of the eluting solution provides a lower throughput and shortens the lifetime of the solid support, due to the successive compression and swelling of this latter. The introduction of the eluting solution in the flow-system can be carried out by inserting a defined volume of that or passing it through the solid support for a period of time.

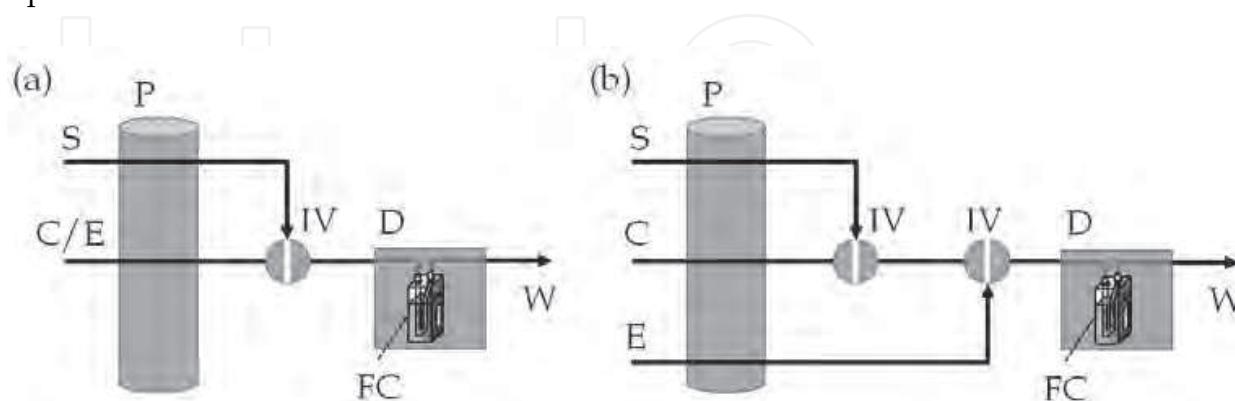

Fig. 2. Manifold configurations for regeneration of the solid support. (a) Without eluting solution; (b) With eluting solution. S, sample solution; C, carrier solution; E, eluting solution; P, peristaltic pump; IV, injection valve; D, detector; FC, flow-cell filled with solid support; W, waste



### 3.4 Mono-sensing optosensors

In this type of flow-based optosensors, the solid support responds only to an analyte in the sample (Table 2). The determination of this latter can be carried out with or without the previous on-line generation of a derivative product.

The direct measurement of a property of the analyte itself is the simplest approach used in the development of flow-based optosensors and it constitutes an interesting contribution to green analytical chemistry since it does not need solutions besides the carrier and (sometimes) eluting solutions. Fluorescence is the most frequently used detection technique in this type of mono-sensing optosensors, although very recently has been proposed the phosphorescence determination of thiabendazole in waters (Piccirilli & Escandar, 2009). An example of these systems is the optosensor developed for the screening of bitertanol in banana samples, in which the native fluorescence of the pesticide was monitored at 261/326 nm after its retention on C<sub>18</sub> silica gel (Llorent et al., 2007). The pre-treatment of the sample was accomplished by QuEChERS methodology (Anastassiades et al., 2003) consisting of an acetonitrile extraction/partitioning and dispersive solid phase extraction (SPE) clean-up with primary secondary amine (PSA). The sensor showed good tolerance to the presence of other common pesticides such as simazine, imazalil, dimethoate or aldicarb. Nevertheless, the interference of carbofuran and carbaryl was very serious and the authors proposed two changes in the procedure in order to their elimination. The proposed method fulfilled the MRL established for bitertanol in banana by European Union, 3 mg kg<sup>-1</sup>.

As fluorescence native is not a common characteristic of pesticides, different strategies have been used for the determination of non-fluorescent pesticides, such as chemical derivation or UV-irradiation. The chemical derivation of the analyte has been carried out by means of the formation of a chromogenic product which is retained on the solid support (Agudo et al., 1993; Guzmán et al., 2006) or using a chemiluminescent reaction (Fang et al., 2009). In this latter application, maleic hydrazide (MH) was selectively immobilized on a MIP filling the flow-cell. Then, luminol and potassium periodate solutions were delivered to the cell and originated strong chemiluminescence. This approach did not provide a high throughput since the measurement involved: (a) immobilization of the analyte on the MIP, (b) washing of the MIP to remove the resting sample solution, (c) delivering of chemiluminescent reagents to the flow-cell, and (d) washing of the MIP for its regeneration. Nevertheless, the MIP used as recognition material of MH allowed to detect this latter in vegetable samples without purification step.

Other interesting strategy for derivation of pesticides is photochemically-induced fluorescence (PIF) technique. It consists of the on-line generation of fluorophores from non-fluorescent or weakly-fluorescent analytes by means of an UV lamp and presents inherent advantages over ordinary chemical reactions such as quicker reaction rate, fewer chemicals involved and smaller dilution factor. The typical manifold used for this strategy is shown in Figure 3. As can be seen, the photodegradation of the pesticide is carried out by inserting a photoreactor just before the detector. This latter is constructed by coiling a PTFE tubing (0.8 mm i.d.) around a low-pressure mercury lamp (8 – 15 W, 254 nm), which is placed into an aluminium box to permit the maximum reflectance of UV light and heat dissipation. An important aspect to take into account in this type of optosensors is that the regenerating solution (carrier itself or eluting solution) has to be able to elute not only the species monitored but other products of the UV irradiation of the analyte, which possibly can remain retained on the solid support and interfere the next determination. This strategy was applied for the first time to the fluorimetric determination of the neonicotinoid insecticide

Pesticide	Principle	Solid phase / flow system	Detector	LOD ( $\mu\text{g L}^{-1}$ )	Reference
Paraquat	reaction with dithionate	Dowex 50W-X8 / FIA	AB	0.11	Agudo & Valcárcel, 1993
1-naphthylamine	Griess reaction	C <sub>18</sub> disk / MSFIA	RF	1.1	Guzmán et al., 2006
Warfarin	inclusion complex	Cyclobond I / FIA	FL	2	Badía & Díaz, 1999
Warfarin	direct measurement	Sephadex QAE A-25 / FIA	FL	4.1	Ruedas et al., 2001
Thiabendazole	direct measurement	nylon powder / FIA	FL	2.8	Piccirilli & Escandar, 2007
Carbaryl	direct measurement	MIP / FIA	FL	0.27	Sánchez et al., 2007
Bitertanol	direct measurement	C <sub>18</sub> / MCFIA	FL	14 <sup>a</sup>	Llorent et al., 2007
Diphenylamine	direct measurement	C <sub>18</sub> / MCFIA	FL	60	J.F. García et al., 2005
Thiabendazole	direct measurement	C <sub>18</sub> / MCFIA	FL	90 <sup>a</sup>	J.F. García et al., 2006
Azoxystrobin	UV irradiation	Sephadex QAE A-25 / MCFIA	FL (PIF)	2.4 <sup>b</sup> 5.4 <sup>c</sup> 6 <sup>d</sup>	López et al., 2007a
Imidacloprid	UV irradiation	C <sub>18</sub> / FIA	FL (PIF)	1.8	López et al., 2007b
Linuron	UV-irradiation; micellar medium	C <sub>18</sub> / FIA	FL (PIF)	220 130	Piccirilli et al., 2008
Metsulfuron methyl	UV-irradiation; micellar medium	C <sub>18</sub> / FIA	FL (PIF)	0.14	López et al., 2009a
Thiabendazole	direct measurement	nylon powder / FIA	PH	4.5	Piccirilli & Escandar, 2009
Maleic hydrazide	reaction with luminol-KIO <sub>4</sub>	MIP / FIA	CH	60	Fang et al., 2009

<sup>a</sup>  $\mu\text{g kg}^{-1}$ ; <sup>b</sup> wine; <sup>c</sup> must; <sup>d</sup> grapes ( $\mu\text{g kg}^{-1}$ ); AB: absorptiometry; RF: reflectometry; FL: fluorescence; PIF: photochemically induced fluorescence; PH: phosphorescence; CH: chemiluminescence; MCFIA: multicommutation flow-injection analysis; FIA: flow-injection analysis; MSFIA: multisyringe flow-injection analysis

Table 2. Mono-sensing flow-based chemical optosensors for pesticide assessment

imidacloprid in vegetables (López et al., 2007b). The on-line photochemical conversion of the insecticide was combined with the measurement of the generated fluorescent photoproduct when retained on C<sub>18</sub> silica gel. The method was applied to the analysis of imidacloprid in peppers, river, well and irrigation waters. The detection limit obtained was comparable to those obtained using conventional chromatographic methods.

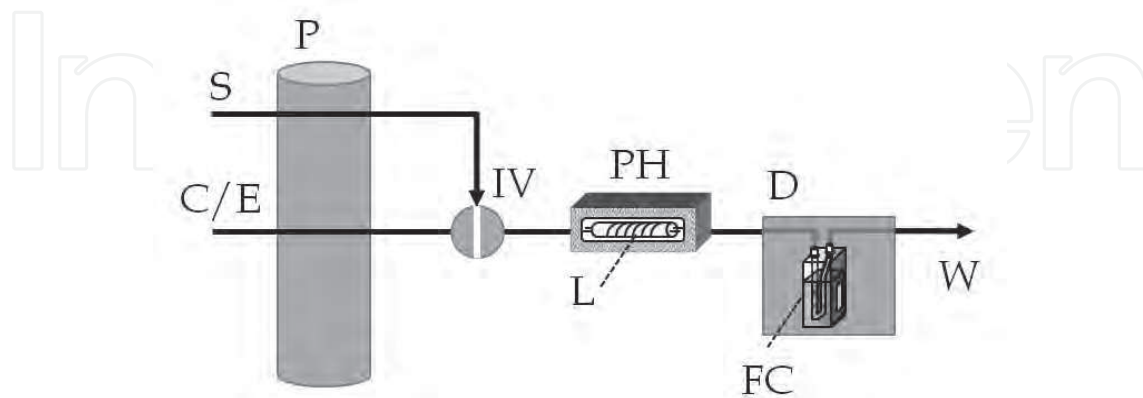

Fig. 3. Manifold configuration for photochemically-induced fluorescence (PIF) detection. S, sample solution; C/E, carrier/eluting solution; P, peristaltic pump; IV, injection valve; PH, photoreactor; L, UV lamp; D, detector; FC, flow-cell filled with solid support; W, waste

### 3.5 Multi-sensing optosensors

When the sensing zone of an optosensor is able to respond to more than one analyte from only an injection of sample, it is called multiparameter or multi-sensing optosensor (Table 3). These systems are more difficult to develop, as more complex series of requirements have to be accomplished for this purpose. Three different strategies have been used in the development of this kind of flow-based optosensors, which have allowed the simultaneous determination of two or three analytes.

#### 3.5.1 Separation in a minicolumn

One of the most frequently used strategies for the development of multi-sensing systems has been the introduction in the flow-system of an on-line minicolumn filled with an appropriate solid support (Figure 4) (Llorent et al. 2005; Ruedas et al., 2002). Its aim is to discriminate in time the arrival of the analytes to the sensing zone. These minicolumns are home-made, in glass, and they are placed just before the flow-cell (Figure 4a). The length of the material packed is a key variable since it has to be sufficient as to allow a complete separation of the analytes in the minimum possible time. Appropriate working conditions have to be established as to allow the selective retention of one (bi-parameter sensor) or two (three-parameter sensor) of the analytes on the solid support packed into the minicolumn, while the other one(s) reach(es) the detection area. This requires a carrier/eluting solution allowing different retention-elution kinetics of the analytes in the minicolumn. After the measurement of the first analyte, the use of additional eluting solutions allows the desorption of the analyte(s) retained in the minicolumn and their transport to the sensing zone. Figure 4b shows the recording signals obtained for the simultaneous determination of three analytes when varying the length (amount) of the solid support packing in the minicolumn. As can be seen, the separation is only possible for a length of "d" mm.

Pesticide	Separation strategy	Solid phase / Flow system	Detector	LOD ( $\mu\text{g L}^{-1}$ )	Reference
Carbofuran propoxur carbaryl	measurement at nine $\lambda$	C <sub>18</sub> / FIA	AB	15 15 15	B. Fernández et al., 1991
Naptalam 1-naphthylamine	measurement at two $\lambda$	Amberlite XAD 7 / FIA	PH	8.1 11.2	Salinas et al., 2004
Thiabendazole metsulfuron methyl	separation in minicolumn	C <sub>18</sub> / FIA	FL (PIF)	2.5 3.3	López et al., 2009b
Fuberidazole carbaryl benomyl	separation in minicolumn	C <sub>18</sub> / FIA	FL	0.09 6 9	J.F. García et al., 2004a
Thiabendazole warfarin	separation in minicolumn	C <sub>18</sub> / FIA	FL	2.35 0.54	Ruedas et al., 2002
Benomyl carbendazim carbofuran	separation in minicolumn	C <sub>18</sub> / FIA	FL	35 15 68	Llorent et al., 2005
Naphtylamine (1- <i>plus</i> 2-isomers)	isosbestic point	MIP / FIA	FL	45 45	Valero et al., 2009a
1-Naphtylamine 2-naphtylamine	PLS-1, N-PLS, U-PLS	MIP / FIA	FL	15 33	Valero et al., 2009b
$\alpha$ -Naphtol o-phenylphenol thiabendazole	PLS	C <sub>18</sub> / FIA	FL	- - -	Domínguez et al., 2007
Fuberidazole o-phenylphenol	separation in the flow-cell	C <sub>18</sub> / MCFIA	FL	0.18 6.1	Llorent et al., 2006
Benomyl carbendazim	separation in the flow-cell	C <sub>18</sub> / FIA	FL	7.5 3.0	J.F. García et al., 2003
Benomyl thiabendazole	separation in the flow-cell	C <sub>18</sub> / FIA	FL	3.6 0.06	J.F. García et al., 2004b

AB: absorptiometry; FL: fluorescence; PIF; photochemically induced fluorescence; PH: phosphorescence; FIA: flow-injection analysis; MCFIA: multicommutation flow-injection analysis

Table 3. Multi-sensing flow-based chemical optosensors for pesticide assessment

Thiabendazole and metsulfuron methyl were simultaneously determined in water samples by placing in the flow system a minicolumn packed with C<sub>18</sub> silica gel, the same solid support used as sensing zone (López et al., 2009b). Firstly, the sample was injected into a 15% methanol solution, which originated a weak retention of thiabendazole in the minicolumn and its elution by the carrier solution itself, being monitored by measuring its native fluorescence. After this, metsulfuron methyl was eluted from the minicolumn with a 60% methanol solution and monitored after its UV-irradiation and generation of a strongly fluorescent photoproduct.

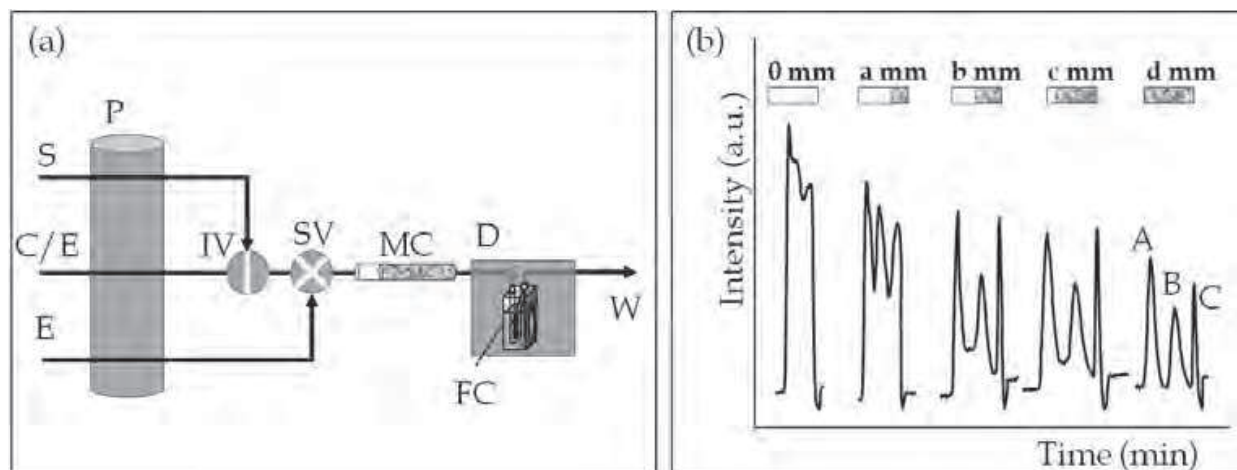

Fig. 4. Simultaneous determination of pesticides using a minicolumn inserted before the flow-cell. (a) Manifold configuration for determination of two species: S, sample solution; C/E, carrier/eluting solution; E, eluting solution; P, peristaltic pump; IV, injection valve; SV, selection valve; MC, minicolumn filled with solid support; D, detector; FC, flow-cell filled with solid support; W, waste. (b) Recording signals obtained for determination of three species (A, B and C) using different amounts (or lengths) of solid support in the minicolumn: d: optimal amount of solid support.

### 3.5.2 Separation in the flow-cell

A very simple design for the on-line separation of analytes, without involving the use of additional devices in the manifold, is the integration of the minicolumn into the same flow-cell. The minicolumn is replaced by the introduction in the flow-cell of an additional amount of solid support and, therefore, the level of support in that is higher than the usual one. The separation of the analytes takes place in the zone of the support above the detection area and allows a sequential arrival of them to this latter. This strategy involves some advantages like: (a) simplicity in manifold and procedure, (b) higher sensitivity, and (c) higher throughput.

As an example, the simultaneous determination of two pesticides, A and B, is shown in Figure 5. The signals recorded for A and B at two different excitation/emission wavelengths ( $\lambda_{ex}/\lambda_{em}$ ) are shown for different additional amounts of solid support in the flow-cell. As can be seen, both analytes show a significant spectral overlapping and their simultaneous determination is not possible without a previous separation.

This strategy has been only used for the simultaneous determination of two pesticides (J.F. García et al., 2003, 2004b; Llorent et al., 2006) by measuring their native fluorescence. In one of the applications developed, multicommutation principles were also applied (Llorent et al. 2006). Fuberidazole and o-phenylphenol could be simultaneously determined, despite their severe spectral overlapping, by using an additional amount of solid support ( $C_{18}$ ) in the flow-cell and two different carrier/eluting solutions. The use of a 30% methanol:water (v/v) solution originated a very strong retention of o-phenylphenol on the upper part of the support, in a zone situated above the irradiated one, while fuberidazole was transiently retained and monitored. Then, a 60% methanol:water (v/v) solution allowed the elution of o-phenylphenol and its monitoring.

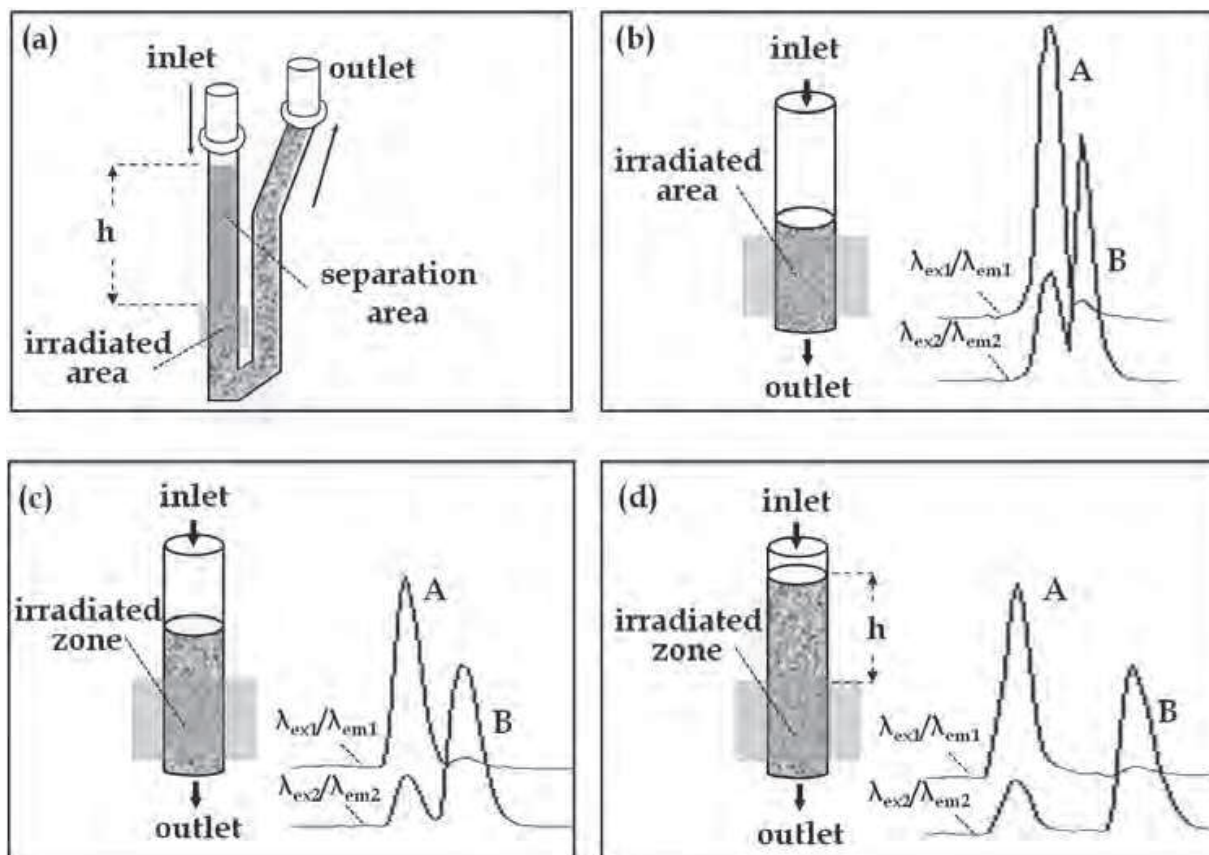

Fig. 5. Simultaneous determination of two analytes (A and B) in the flow-cell itself: (a) detail of the flow-cell filled with an additional amount of solid support; (b) - (d) recording signals of A and B for different amounts of solid support. h: optimal height of solid support above the detection area

### 3.5.3 Separation with mathematical treatment

The simultaneous determination of two or three analytes can be also carried out without their previous on-line separation, but making use of a mathematical treatment of their analytical signals. Several chemometrics algorithms such as first-order multivariate calibration partial least-squares (PLS) algorithm and second-order algorithms such as multiway PLS (N-PLS) and unfolded PLS (U-PLS) have been applied for this purpose. These approaches can resolve overlapping signals and reduce interference problems as well as background noise (Picón et al., 2000). In this way, the resolution of three pesticides,  $\alpha$ -naphthol, thiabendazole and o-phenylphenol, at  $\mu\text{g L}^{-1}$  level was possible by developing a FIA-based system with fluorimetric detection, using  $\text{C}_{18}$  silica gel as active sorbent substrate in the flow-cell (Domínguez et al., 2007).

## 4. Flow-based biosensors

Biosensors have been defined as analytical devices which tightly combine biorecognition elements with physical transducers for detection of the target compounds (Guilbault et al., 2004). The majority of biosensors developed to date have used an antibody or enzyme (purified or in the form of whole cells) as the biocomponent, being fluorescence and chemiluminescence the most frequently used detection techniques. The biological

recognition element is usually immobilized in an immunoreactor placed before the flow-cell. As stated in *Introduction*, these systems cannot be considered strictly as flow-through optosensors, since the analytical measurement is carried out in solution. Nevertheless, they will be also reviewed here. To the best of our knowledge, to date only two flow-through biosensors, in which the biorecognition element is placed into the flow-cell, have been proposed (Pulido et al., 2000, 2006).

#### 4.1 Enzyme inhibition-based biosensors

Many biosensors which are used for pesticide detection are based on the inhibition reaction of several enzymes in the presence of pesticides. In these biosensors, the biological element is an enzyme which reacts selectively with its substrate. Given that pesticides selectively inhibit the activity of certain enzymes, their activity and the resulting product concentration is affected. This inhibition is analytically useful and has been used advantageously in the development of many biosensing devices. The development of biosensors based on immobilized enzymes came about to solve several problems such as loss of enzyme (especially if expensive), maintenance of enzyme stability and shelf life of the biosensor, and additionally to reduce the time of the enzymatic response (Amine et al., 2006). Enzymes immobilized on suitable supports and packed into a reactor column, in combination with a flow injection system, have been widely used as biological recognition elements of biosensors for on-line monitoring of pesticides. The inhibition of the enzyme activity can be monitored by different optical techniques, being chemiluminescence the most frequently used technique. The chemical immobilization of the enzyme involves the formation of a covalent bond between some groups of the enzyme and a water-insoluble support (M. García et al., 1986).

Biosensing analytical devices, based on the acetylcholinesterase (AChE) inhibition test, using the monitoring of hydrogen peroxide generated as a result of the oxidation of choline produced from acetylcholine hydrolysis in the presence of choline oxidase have been reported for the quantification of carbamate and organophosphorus pesticides. In one of these approaches a column, placed inside a luminometer, was packed with choline oxidase and peroxidase immobilized on methacrylate beads and AChE was added to the samples or immobilized in another column packed with the same solid support but placed outside the luminometer (Roda et al., 1994). The use of soluble AChE provided the best results when comparing with immobilized enzyme. The developed system allowed the determination of paraoxon and aldicarb with detection limits of 0.75 and 4  $\mu\text{g L}^{-1}$ , respectively. It was applied to the analysis of paraoxon in water, soil and vegetables.

In other work, cholinesterase (ChE) was immobilized in a gel obtained by hydrolysis and condensation of tetramethyl orthosilicate (TMOS) (Navas & Ramos, 1997). A non-fluorescent synthetic substrate (indoxy-acetate) was hydrolyzed by ChE to yield a highly fluorescent product (indoxy), whose rate of formation was lowered in the presence of organophosphorus pesticides due to the inhibition of the enzyme.

Some authors have used a pH-sensitive transducer in the development of optical AChE-based biosensors. In these systems, the pH change generated by the release of acetic acid during the enzymatic reaction between acetyl choline and AChE is measured. The monitoring of the pH change can be carried out by using a colorimetric or fluorimetric indicator such as fluorescein isothiocyanate (FITC) (Rogers et al., 1991), thymol blue (Andres & Narayanaswamy, 1997) or chlorophenol red (Xavier et al., 2000).

#### 4.2 Photosystem II (PSII)-based biosensors

These biosensors are reported to be able to detect herbicides such as triazine, diazines, phenolic and urea herbicides in the environment (Moreland & Novitzky, 1987; Vedrine et al., 2003). These substances inhibit photosynthetic electron flow by blocking the PSII quinone binding site and thus modify chlorophyll fluorescence. Some of these biosensing systems use isolated chloroplasts or intact cells of algae. Based on this principle a multi-strain algal biosensor was constructed for the rapid detection of five water-soluble herbicides. Nine microalgal strains were immobilized on an array biochip using permeable membranes and chlorophyll fluorescence was monitored (Podola & Melkonian, 2005). This inhibition capacity has also been used for the development of a chemiluminescent biosensor to detect low levels of atrazine and diuron (Varsamis et al., 2008). Thylakoid membranes, isolated from fresh spinach leaves, and horseradish peroxidase (HRP) enzyme were immobilized on magnetic beads and chemiluminescence of the photosynthetically produced  $H_2O_2$  was measured, which was disrupted by both herbicides. The integration of the two-step reaction was achieved by designing a micro-system consisting of two Perspex (polymethylmethacrylate) blocks sandwiching a short fluidic channel made from silicon elastomer. The system contained two active zones: (i) immobilized PSII and (II) immobilized HRP to catalyze luminol/hydrogen peroxide chemiluminescence. The limits of detection obtained were 0.14 and 0.043 ng L<sup>-1</sup> for atrazine and diuron, respectively.

#### 4.3 Immunosensors

Immunosensors are biosensors that use antibodies (Ab) or antigens (Ag) as the specific sensing element and provide concentration-dependent signals. They consist of two processes, a molecular recognition process, for sensing the specific Ag-Ab binding reaction at the surface of receptor, and a signal-transfer process, for responding to changes in a parameter of the receptor caused by the specific binding. They have also shown to be useful for the determination of pesticides in water, food and soil samples. Among the advantages of these methodologies we can point out the high sensitivity and selectivity of antibodies which, in many cases, allows the direct detection of the target analytes in buffered samples without further treatment. Immunosensors can be divided into two classes, depending on if labels are used or not: labeled type and label-free type (Jiang et al., 2008).

##### 4.3.1 Labeled-type

In labeled immunosensors, a label is used to quantify the amount of Ab or analyte bound during an incubation step. For this purpose, enzymes such as HRP, glucose oxidase and fluorescent or electrochemiluminescent probes have been widely used. The amount of target analyte can be inferred from the amount of labels that binds to the solid support. Usually, two different approaches are used: *sandwich* and *competitive* assays (Figure 6).

The *sandwich assay* consists of two recognition steps. In the first step, the Ab is immobilized on a transducer surface, which allows capturing the analyte of interest. In the second step, a labeled secondary Ab is added to bind with the previously captured analyte. The immunocomplexes (immobilized Ab-analyte-labeled Ab) are formed and the signals from labels are proportional to analyte concentration.

In *competitive assays*, the analyte and a constant amount of labeled analyte compete for a limited number of Ab binding sites. As the analyte concentration increases, a minor amount



of labeled analyte is retained on the transducer, originating a decrease in the signal if Ab-bound labeled analyte is detected (Herranz et al., 2008).

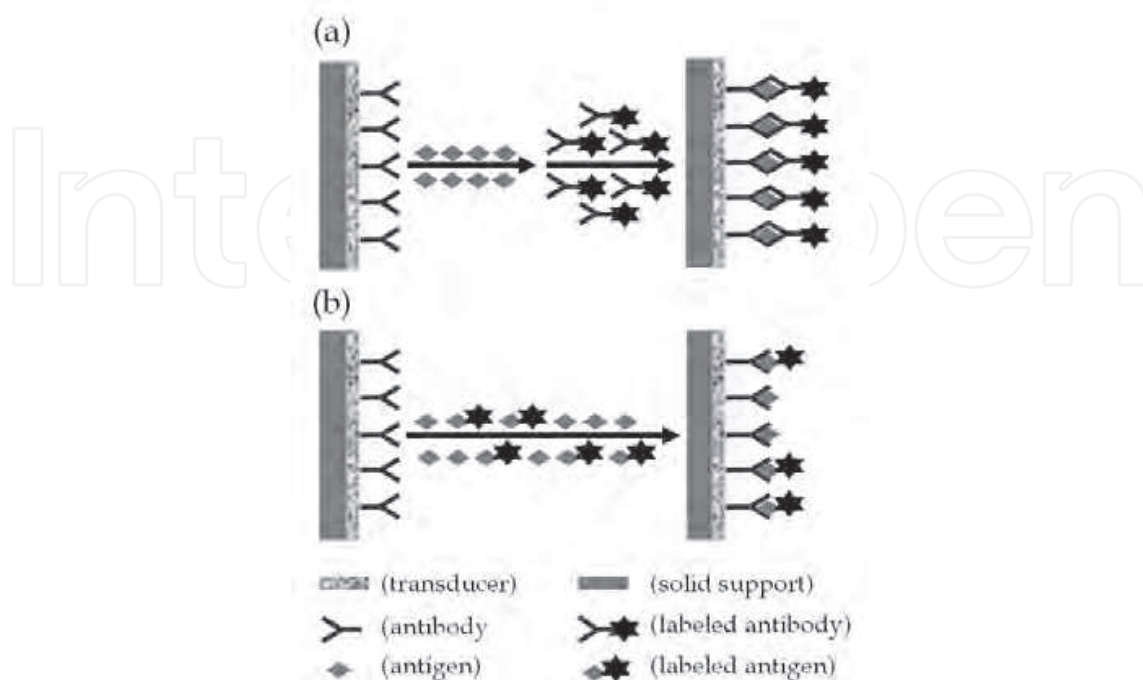

Fig. 6. Diagram for labeled immunosensors. (a) *sandwich assay*; (b) *competitive assay*

Two different strategies are used for the determination of the target species: (i) the solid support is placed into an immunoreactor column (reactor) and the amount of labeled analyte bound to the Ab is monitored; (ii) the solid support is placed into a flow-cell in the detector and the analytical signal of the labeled analyte-Ab complex is measured. The first strategy has been the most frequently used in the development of immunosensors for the determination of pesticides (Figure 7), implementing SIA methodology. However, these systems cannot be called flow-through optosensors, since the measurement is carried out in solution.

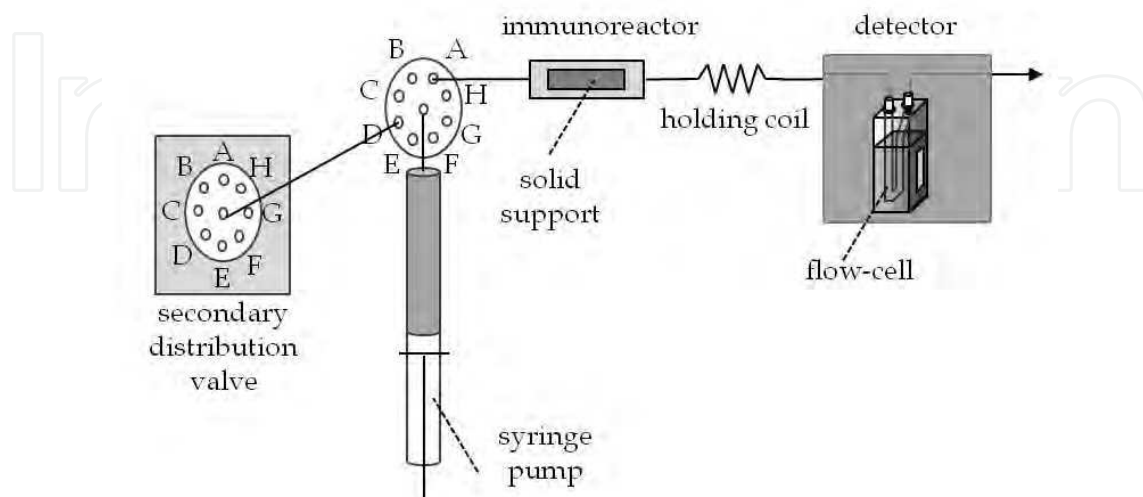

Fig. 7. SIA manifold used in labeled immunosensors, with immobilization of antibody in an immunoreactor

An example of biosensors including an immunoreactor is the derivatization-assisted enzyme immunosensor developed for the determination of glyphosate in water and soil samples (González et al., 2005). Enzyme substrates 3-(p-Hydroxyphenyl)-propanoic acid (HPPA) and  $H_2O_2$  were used and the product of the enzymatic reaction was transferred from the reactor to the flow cell and the fluorescence peak was registered.

On the other hand, it is worth of mentioning the immunosensor proposed for determination of isoproturon in drinking water (Pulido et al., 2006). The solid support used, consisting of a sol-gel glass doped with anti-isoproturon monoclonal antibody, was placed in this case into the flow-cell of the spectrofluorimeter. Free isoproturon in solution competed with a fluorescent conjugated isoproturon and reduced the support bonded fluorescence in a concentration-dependent manner. A detection limit of  $9.7 \text{ ng L}^{-1}$  was obtained and recoveries higher than 90% for tap and well water. A similar fluoroimmunosensor for isoproturon, using two different solid supports (CPG and CPG-Protein A) and placing the immobilized Ab directly into a flow-cell located in the detection area, was also described (Pulido et al., 2000).

Antibody immobilization on solid-phase has been carried out by using several coupling strategies, such as immobilization via controlled pore glass (CPG) (González et al., 1997), controlled pore glass bound to protein A (CPGA) (Herranz et al., 2008) or Protein A/G (González et al., 2005). Although the labeled immunosensors are usually more sensitive, they usually are not capable of real-time monitoring of the Ab-analyte reaction and increase both operation and development costs compared to label-free immunosensors.

#### 4.3.2 Label-free type

Two different strategies, both based on competitive formats, have been used for the development of label-free immunosensors: *direct* and *indirect* determination. In the first type, the analytical signal measured is directly proportional to the concentration of analyte, being its main advantage simplicity of the system. The second type, based on an inhibition test, has been proven to be an effective method for the determination of pesticides. Firstly, a protein conjugate of the pesticide is immobilized onto the surface of a transducer, and then analyte-Ab mixtures are preincubated in solution. After being injected on the sensor surface, a competition is established between the analyte present in solution and pesticide protein-conjugate on solid support. Consequently, Ab binding to the immobilized conjugate is inhibited by the presence of the target pesticide. Surface plasmon resonance (SPR) technology is the most usually used detection system for this kind of immunosensors. SPR immunosensing involves the immobilization of Ab (or analyte) on a thin gold surface deposited on the reflecting surface of a glass prism. Interaction of both analyte and Ab on the surface originates a change in the refractive index of the solution due to shifts in mass occurring after biomolecule binding (Dutra & Kubot, 2007). This change is directly related to the concentration of analyte in the surface layer. Some of the main advantages of SPR technology are its versatility and capability of monitoring binding interactions without the need for labeling of the target compounds and its outstanding attributes of miniaturization and portable instrumentation.

A rapid and simple immunosensor for indirect determination of the herbicide 2,4-dichlorophenoxyacetic acid (2,4-D) was developed based on surface plasmon resonance (SPR) technology (Gobi et al., 2007). The sensor device was fabricated by simple physical adsorption of an ovalbumin conjugate of 2,4-D on an SPR thin-film gold chip. The selective

binding of a monoclonal Ab against 2,4-D (2,4-D-Ab) is followed by an increase in SPR angle. The biosensor allowed a detection limit of  $0.1 \mu\text{g L}^{-1}$  and showed a high tolerance to the presence of 2,4,5-trichlorophenoxyacetic acid (2,4,5-T).

It is also worth mentioning the performance of a SPR immunosensor system for the simultaneous detection of DDT, chlorpyrifos and carbaryl (Mauriz et al., 2007). The multi-assay was carried out by using a two-channeled configuration for multiple immobilizations of derivatives of the three pesticides. Different immobilization formats were used. The immobilization of a single derivative allowed the simultaneous monitoring of antibody interactions occurring separately on each individual flow cell. In contrast, multisurface sensor with several immobilized derivatives involved the use of one independent flow cell for the analysis of two or three analytes.

Tables 4 and 5 show some of the flow-based biosensors developed for determination of pesticides.

Pesticide	Principle	Solid Phase/ Flow system	Detector	LOD ( $\mu\text{g L}^{-1}$ )	Reference
Simazine	antibody (labeled type)	CPGA / SIA	FL	0.0013	Herranz et al., 2008
Carbaryl	antibody (labeled type)	CPG / SIA	FL	0.029	González et al., 1997
Glyphosate	antibody (labeled type)	Protein A/G / SIA	FL	0.021	González et al., 2005
1-naphtol	antibody (labeled type)	Protein A/G / SIA	FL	12	Penalva et al., 2000
Isoproturon	antibody (labeled type)	CPGA CPG / FIA	FL	3.0-4.5 3.0	Pulido et al., 2000
Isoproturon	antibody (labeled type)	sol-gel glass / FIA	FL	0.0097	Pulido et al., 2006
2,4-D	antibody (label-free type)	gold film / FIA	SPR	0.1	Gobi et al., 2007
Atrazine	antibody (label-free type)	gold film / FIA	SPR	0.020	Farré et al., 2007
DDT carbaryl chlorpyrifos	antibody (label-free type)	gold film / FIA	SPR	0.018 0.050 0.052	Mauriz et al., 2007

FL: fluorescence; SPR: surface plasmon resonance; CPG: controlled pore glass; CPGA: controlled pore glass bound to protein A

Table 4. Applications of flow-based immunosensors to pesticide assessment

Pesticide	Principle	Solid Phase/ Flow system	Detector	LOD ( $\mu\text{g L}^{-1}$ )	Reference
Paraoxon aldicarb	AChE inhibition	Eupergit C / FIA	CH	0.75 4	Roda et al., 1994
Methidation naled mecarbam fenitrothion azinphos-ethyl	ChE inhibition	sol-gel crystal/ FIA	FL	57600 360 13900 17800 17900	Navas & Ramos,1997
Bendiocarb methomyl echothiophate paraoxon	AChE inhibition	quartz fibers / FIA	FL	- - - -	Rogers et al., 1991
Carbofuran paraoxon	AChE inhibition	ITC glass / FIA	RF	3.1 24.7	Andres & Narayanas- wamy, 1997
Propoxur carbaryl	AChE inhibition	CPG / FIA	RF	8 500	Xavier et al., 2000
Atrazine simazine isoproturon diuron DNOC	inhibition of PSII in algae	quartz microfibre filter / FIA	FL	0.25 0.5 0.025 0.025 5	Vedrine et al., 2003
Atrazine diuron paraquat simazine isoproturon	inhibition of PSII in algae	array biochip membrane / FIA	FL	0.5 - 10	Podola & Melkonian, 2005
Atrazine diuron	inhibition of PSII in thylakoid membranes	magnetic beads / FIA	CH	1.4E-04 4.3E-05	Varsamis et al., 2008

AChE: acetylcholinesterase; ChE: cholinesterase; PSII: photosystem II; RF: reflectometry; FL: fluorescence; CH: chemiluminescence; CPG: controlled pore glass; ITC: isothiocyanate; FIA: flow-injection analysis

Table 5. Applications of flow enzyme- and photosystem-II-based biosensors to pesticide assessment

## 5. Conclusions

Flow-based optosensors constitute a simple and inexpensive tool for routine analysis of pesticides. They offer advantages such as high sensitivity, high selectivity, high throughput, low cost of equipment and they can be considered as an interesting alternative to the well established chromatographic methods (HPLC and GC). The recent introduction of new flow methodologies such as SIA, MCFIA and MSFIA has allowed remarkable improvements in

flow systems such as higher repeatability, minor consumption of sample and reagents, complete automation, robustness, versatility and minimization of waste generation. All these methodologies have proven their applicability to the analysis of pesticides in complex matrices, with detection limits comparable to those obtained with chromatographic methods. To date, the proposed flow-based optosensors have shown to be very useful for the monitoring of one, two or three pesticides. Therefore, they are not appropriate for multiresidue analysis, although they are very useful for a preliminary screening in laboratories where a large number of samples have to be processed in a short time. In the future, the implementation of other flow methodologies such as multipumping or lab-on-valve could contribute to enhance miniaturization and versatility of systems in the design of automatic methods for routine analysis.

## 6. References

- Agudo, M., Ríos, A. & Valcárcel, M. (1993). Automatic continuous-flow determination of paraquat at the subnanogram per millilitre level. *Analytica Chimica Acta*, Vol. 281, No. 1, (September 1993), pp. 103-109, ISSN: 0003-2670
- Ahmed, F.E. (2001). Analyses of pesticides and their metabolites in foods and drinks. *TrAC Trends in Analytical Chemistry*, Vol. 20, No. 11, (November 2001), pp. 649-661, ISSN 0165-9936
- Alexander, C., Andersson, H.S., Andersson, L.I., Ansell, R.J., Kirsch, N., Nicholls, I.A., O'Mahony, J. & Whitcombe, M.J. (2003). Molecular imprinting science and technology: a survey of the literature for the years up to and including 2003. *Journal of Molecular Recognition*, Vol. 19, No. 2, (March/April 2006), pp. 106-180, ISSN: 0952-3499
- Amine, A., Mohammadi, H., Bourais, I. & Palleschi, G. (2006). Enzyme inhibition-based biosensors for food safety and environmental monitoring. *Biosensors and Bioelectronics*, Vol. 21, No. 8, (February 2006), pp. 1405-1423, ISSN: 0956-5663
- Anastassiades, M., Lehotay, S. J., Štajnbaher, D. & Schenck, F. J. (2003). Fast and easy multiresidue method employing acetonitrile extraction/partitioning and "dispersive solid-phase extraction" for the determination of pesticide residues in produce. *Journal of AOAC International*, Vol. 86, No. 2, (March/April 2003), pp. 412-431, ISSN: 1060-3271
- Andres, R.T. & Narayanaswamy, R. (1997). Fibre-optic pesticide biosensor based on covalently immobilized acetylcholinesterase and thymol blue. *Talanta*, Vol. 44, No. 8, (August 1997), pp. 1335-1352, ISSN: 0039-9140
- Badía, R. & Díaz-García, M.E. (1999). Cyclodextrin-based optosensor for the determination of warfarin in waters. *Journal of Agricultural and Food Chemistry*, Vol. 47, No. 10, (September 1999), pp. 4256-4260, ISSN: 0308-8146
- Domínguez-Vidal, A., Ortega-Barrales, P. & Molina-Díaz, A. (2007). Environmental Water Samples Analysis of Pesticides by Means of Chemometrics Combined with Fluorimetric Multi-optosensing. *Journal of Fluorescence*, Vol. 17, No. 3, (March 2007), pp. 271-277, ISSN: 1053-0509
- Dutra, R.F. & Kubot, L.T. (2007). An SPR immunosensor for human cardiac troponin T using specific binding avidin to biotin at carboxymethyl-dextran-modified gold chip.

- Clinica Chimica Acta*, Vol. 376, No. 1-2, (February 2007), pp. 114-120, ISSN: 0009-8981
- European Union. (2005). Regulation (EC) No 396/2005 of the European Parliament and of the Council of 23 February 2005 on maximum residue levels of pesticides in or on food and feed of plant and animal origin and amending Council Directive 91/414/EEC. *Official Journal of the European Union*, Vol. L 70, (March 2005), pp. 1-47, ISSN 1725-2555
- Fang, Y., Yan, S., Ning, B., Liu, N., Gao, Z. & Chao, F. (2009). Flow injection chemiluminescence sensor using molecularly imprinted polymers as recognition element for determination of maleic hydrazide. *Biosensors and Bioelectronics*, Vol. 24, No. 8, (April 2009), pp. 2323-2327, ISSN: 0956-5663
- Farré, M., Martínez, E., Ramón, J., Navarro, A., Radjenovic, J., Mauriz, E., Lechuga, L., Marco, M.P. & Barceló, D. (2007). Part per trillion determination of atrazine in natural water samples by a surface plasmon resonance immunosensor. *Analytical and Bioanalytical Chemistry*, Vol. 388, No. 1, (March 2007), pp. 207-214, ISSN: 1618-2642
- Fernández-Band, B., Linares, P., Luque De Castro, M.D. & Valcárcel, M. (1991). Flow-Through Sensor for the Direct Determination of Pesticide Mixtures without Chromatographic Separation. *Analytical Chemistry*, Vol. 63, No. 17, (September 1991), pp. 1672-1675, ISSN: 0003-2700
- Fernández de Córdova, M.L., Ortega Barrales, P. & Molina Díaz, A. (1998). Sensitive and selective determination of diclofenac sodium in pharmaceutical preparations by solid phase ultraviolet absorptiometry. *Analytica Chimica Acta*, Vol. 369, No. 3, (August 1998), pp. 263-268, ISSN: 0003-2670
- Fu, L., Liu, X., Hu, J., Zhao, X., Wang, H., Huang, C. & Wang, X. (2009) Determination of two pesticides in soils by dispersive liquid-liquid microextraction combined with LC-fluorescence detection. *Chromatographia*, Vol. 70, No. 11-12, (December 2009), pp. 1697-1701, ISSN: 0009-5893
- García-Reyes, J.F., Llorent-Martínez, E.J., Ortega-Barrales, P. & Molina-Díaz, A. (2004a). Multiwavelength fluorescence based optosensor for simultaneous determination of fuberidazole, carbaryl and benomyl. *Talanta*, Vol. 64, No. 3, (October 2004), pp. 742-749, ISSN: 0039-9140
- García-Reyes, J.F., Ortega-Barrales, P. & Molina-Díaz, A. (2004b). Development of a Single Fluorescence-Based Optosensor for Rapid Simultaneous Determination of Fungicides Benomyl and Thiabendazole in Waters and Commercial Formulations. *Journal of Agricultural and Food Chemistry*, Vol. 52, No. 8, (April 2004), pp. 2197-2202, ISSN: 0308-8146
- García-Reyes, J.F., Ortega-Barrales, P. & Molina-Díaz, A. (2005). Rapid Determination of Diphenylamine Residues in Apples and Pears with a Single Multicommuted Fluorometric Optosensor. *Journal of Agricultural and Food Chemistry*, Vol. 53, No. 26, (December 2005), pp. 9874-9878, ISSN: 0308-8146
- García-Reyes, J.F., Llorent-Martínez, E.J., Ortega-Barrales, P. & Molina-Díaz, A. (2006). Determination of thiabendazole residues in citrus fruits using a multicommuted

- fluorescence-based optosensor. *Analytica Chimica Acta*, Vol. 557, No. 1-2, (January 2006), pp. 95–100, ISSN: 0003-2670
- García Roig, M., Bello Estevez, F., González Velasco, F., Ghais, N.I. & Cachaza Silverio, J.M. (1986). Biotechnology and applied biology section: Methods for immobilizing enzymes. *Biochemical Education*, Vol. 14, No. 4, (October 1986), pp. 180-185, ISSN: 0307-4412
- Garrido Frenich, A., Martínez Salvador, I., Martínez Vidal, J.L. & López-López, T. (2005). Determination of multiclass pesticides in food commodities by pressurized liquid extraction using GC-MS/MS and LC-MS/MS. *Analytical and Bioanalytical Chemistry*, Vol. 383, No. 7-8, (November 2005), pp. 1106-1118, ISSN: 1618-2642
- Gobi, K.V., Kim, S.J., Tanaka, H., Shoyama, Y. & Miura, N. (2007). Novel surface plasmon resonance (SPR) immunosensor based on monomolecular layer of physically-adsorbed ovalbumin conjugate for detection of 2,4-dichlorophenoxyacetic acid and atomic force microscopy study. *Sensors and Actuators B*, Vol. 123, No. 1, (April 2007), pp. 583–593, ISSN: 0925-4005
- González Martínez, M.A., Morais, S., Puchades, R., Maquieira, A., Abad, A. & Montoya, A. (1997). Development of an automated controlled-pore glass flow-through immunosensor for carbaryl. *Analytica Chimica Acta*, Vol. 347, No. 1-2, (July 1997), pp. 199–205, ISSN: 0003-2670
- González-Martínez, M.A., Brun, E.M., Puchades, R., Maquieira, A., Ramsey, K. & Rubio, F. (2005). Glyphosate Immunosensor. Application for Water and Soil Analysis. *Analytical Chemistry*, Vol. 77, No. 13, (May 2005), pp. 4219–4227, ISSN: 0003-2700
- Guan, H., Brewer, W.E., Garris, S.T. & Morgan, S.L. (2010). Disposable pipette extraction for enrichment of pesticides from fruits and vegetables and direct analysis by GC/MS. *Journal of Chromatography A*, Vol. 1217, No. 12, (January 2010), pp. 1867–1874, ISSN: 0021-9673
- Guilbault, G.G., Pravda, M. & Kreuzer, M. (2004). Biosensors—42 Years and Counting. *Analytical Letters*, Vol. 37, No. 8, (December 2004), pp. 1481–1496, ISSN: 0003-2719
- Guzmán Mar, J.L., López Martínez, L., López de Alba, P.L., Castrejón Durán, J.E. & Cerdà Martín, V. (2006). Optical fiber reflectance sensor coupled to a multisyringe flow injection system for preconcentration and determination of 1-naphthylamine in water samples. *Analytica Chimica Acta*, Vol. 573–574, (July 2006), pp. 406–412, ISSN: 0003-2670
- Herranz, S., Ramón-Azcón, J., Benito-Peña, E., Marazuela, M.D., Marco, M.P. & Moreno-Bondi, M.C. (2008). Preparation of antibodies and development of a sensitive immunoassay with fluorescence detection for triazine herbicides. *Analytical and Bioanalytical Chemistry*, Vol. 391, No. 5, (February 2008), pp. 1801–1812, ISSN: 1618-2642
- Hunter, R.E., Jr., Riederer, A.M. & Ryan, P.B. (2010). Method for the determination of organophosphorus and pyrethroid pesticides in food via gas chromatography with electron-capture detection. *Journal of Agricultural and Food Chemistry*, Vol. 58, No. 3, (February 2010), pp 1396–1402, ISSN: 0308-8146

- Jiang, X., Li, D., Xu, X., Ying, Y., Li, Y., Ye, Z. & Wang, J. (2008). Immunosensors for detection of pesticide residues. *Biosensors and Bioelectronics*, Vol. 23, No. 11, (June 2008), pp. 1577–1587, ISSN: 0956-5663
- Llorent-Martínez, E.J., García-Reyes, J.F., Ortega-Barrales, P. & Molina-Díaz, A. (2005). Flow-through fluorescence-based optosensor with on-line solid-phase separation for the simultaneous determination of a ternary pesticide mixture. *Journal of AOAC International*, Vol. 88, No. 3, (May 2005), pp. 860–865, ISSN: 1060-3271
- Llorent-Martínez, E.J., Ortega-Barrales, P. & Molina-Díaz, A. (2006). Multi-commutated Flow-through Multi-optosensing: A Tool for Environmental Analysis. *Spectroscopy Letters*, Vol. 39, No. 6, (December 2006), pp. 619–629, ISSN: 0038-7010
- Llorent-Martínez, E.J., García-Reyes, J.F., Ortega-Barrales, P. & Molina-Díaz, A. (2007). Multicommutated fluorescence based optosensor for the screening of bitertanol residues in banana samples. *Food Chemistry*, Vol. 102, No. 3, (July 2007), pp. 676–682, ISSN: 0308-8146
- López-Flores, J., Molina-Díaz, A. & Fernández-de Córdova, M.L. (2007a). Determination of azoxystrobin residues in grapes, musts and wines with a multicommutated flow-through optosensor implemented with photochemically induced fluorescence. *Analytica Chimica Acta*, Vol. 585, No. 1, (February 2007), pp. 185–191, ISSN: 0003-2670
- López-Flores, J., Molina Díaz, A. & Fernández de Córdova, M.L. (2007b). Development of a photochemically induced fluorescence-based optosensor for the determination of imidacloprid in peppers and environmental waters. *Talanta*, Vol. 72, No. 3, (May 2007), pp. 991–997, ISSN: 0039-9140
- López-Flores, J., Fernández de Córdova, M.L. & Molina Díaz, A. (2009a). Flow-through optosensing device implemented with photochemically-induced fluorescence for the rapid and simple screening of metsulfuron methyl in environmental waters. *Journal of Environmental Monitoring*, Vol. 11, No. 5, (March 2009), pp. 1080–1085, ISSN: ISSN: 1464-0325
- López-Flores, J., Fernández-de Córdova, M.L. & Molina-Díaz, A. (2009b). Simultaneous Flow-Injection Solid-Phase Fluorometric Determination of Thiabendazole and Metsulfuron Methyl Using Photochemical Derivatization. *Analytical Sciences*, Vol. 25, No. 5, (May 2009), pp. 681–686, ISSN: 0910-6340
- Matsuoka, S. & Yoshimura, K. (2010). Recent trends in solid phase spectrometry: 2003–2009. A Review. *Analytica Chimica Acta*, Vol. 664, No. 1, (April 2010), pp. 1–18, ISSN: 0003-2670
- Mauriz, E., Calle, A., Manclús, J.J., Montoya, A. & Lechuga, L.M. (2007). Multi-analyte SPR immunoassays for environmental biosensing of pesticides. *Analytical and Bioanalytical Chemistry*, Vol. 387, No. 4, (October 2006), pp. 1449–1458, ISSN: 1618-2642
- Moreland, D.E. & Novitzky, W.P. (1987). Interference by herbicides of the transmembrane potential of thylakoids. *Zeitschrift für Naturforschung C*, Vol. 42, p. 718, ISSN 0939-5075



- Navas Díaz, A. & Ramos Peinado, M.C. (1997). Sol-gel cholinesterase biosensor for organophosphorus pesticide fluorimetric analysis. *Sensors and Actuators B*, Vol. 38-39, No. 1-3, (March 1997), pp. 426-431, ISSN: 0925-4005
- Pang, G.F., Liu, Y.M., Fan, C.L., Zhang, J.J., Cao, Y.Z., Li, X.M., Li, Z.Y., Wu, Y.P. & Guo, T.T. (2006). Simultaneous determination of 405 pesticide residues in grain by accelerated solvent extraction then gas chromatography-mass spectrometry or liquid chromatography-tandem mass spectrometry. *Analytical and Bioanalytical Chemistry*, Vol. 384, No. 6, (March 2006), pp. 1366-1408, ISSN: 1618-2642
- Penalva, J., Puchades, R., Maquieira, A., Gee, S. & Hammock, B.D. (2000). Development of immunosensors for the analysis of 1-naphthol in organic media. *Biosensors and Bioelectronics*, Vol. 15, No. 3-4, (June 2000), pp. 99-106, ISSN: 0956-5663
- Piccirilli, G.N. & Escandar, G.M. (2007). A novel flow-through fluorescence optosensor for the determination of thiabendazole. *Analytica Chimica Acta*, Vol. 601, No. 2, (October 2007), pp. 196-203, ISSN: 0003-2670
- Piccirilli, G.N., Escandar, G.M., Cañada, F.C., Merás, I.D. & de la Peña, A.M. (2008). Flow-through photochemically induced fluorescence optosensor for the determination of linuron. *Talanta*, Vol. 77, No. 2, (December 2008), pp. 852-857, ISSN: 0039-9140
- Piccirilli, G.N. & Escandar, G.M. (2009). Flow injection analysis with on-line nylon powder extraction for room-temperature phosphorescence determination of thiabendazole. *Analytica Chimica Acta*, Vol. 646, No. 1-2, (July 2009), pp. 90-96, ISSN: 0003-2670
- Picón-Zamora, D., Martínez-Galera, M., Garrido-Frenich, A. & Martínez-Vidal, J.L. (2000). Trace determination of carbendazim, fuberidazole and thiabendazole in water by application of multivariate calibration to cross-sections of 3-dimensional excitation-emission matrix fluorescence. *Analyst*, Vol. 125, No. 6, (June 2000), pp. 1167-1174, ISSN: 0003-2654
- Podola, B. & Melkonian, M. (2005). Selective real-time herbicide monitoring by an array chip biosensor employing diverse microalgae. *Journal of Applied Phycology*, Vol. 17, No. 3, (May 2005), pp. 261-271, ISSN: 0021-9010
- Pulido-Tofiño, P., Barrero-Moreno, J.M. & Pérez-Conde, M.C. (2000). Flow-through fluoroimmunosensor for isoproturon determination in agricultural foodstuff. Evaluation of antibody immobilization on solid support. *Analytica Chimica Acta*, Vol. 417, No. 1, (July 2000), pp. 85-94, ISSN: 0003-2670
- Pulido-Tofiño, P., Barrero-Moreno, J.M. & Pérez-Conde, M.C. (2006). Analysis of isoproturon at trace level by solid phase competitive fluoroimmunosensing after enrichment in a sol-gel immunosorbent. *Analytica Chimica Acta*, Vol. 562, No. 1, (March 2006), pp. 122-127, ISSN: 0003-2670
- Richter, P., Toral, M.I. & Castro, H. (2002). Solid phase spectrophotometric determination of copper in water by using immobilized zincon in a Sephadex A25 resin. *Analytical Letters*, Vol. 35, No. 4, pp. 635 - 646, ISSN: 0003-2719
- Roda, A., Rauch, P., Ferri, E., Girotti, S., Ghini, S., Carrea, G. & Bovara, R. (1994). Chemiluminescent flow sensor for the determination of Paraoxon and Aldicarb pesticides. *Analytica Chimica Acta*, Vol. 294, No. 1, (August 1994), pp. 35-42, ISSN: 0003-2670

- Rogers, K.R., Cao, C.J., Valdes, J.J., Eledfrawi, A.T. & Eldefrawi, M.E. (1991). Acetylcholinesterase Fiber-Optic Biosensor for Detection of Anticholinesterases. *Fundamental and Applied Toxicology*, Vol. 16, No. 4, (May 1991), pp. 810–820, ISSN 0272-0590
- Ruedas-Rama, M.J., Ruiz-Medina, A. & Molina-Díaz, A. (2001). A flow-through sensing device with fluorometric transduction for the determination of warfarin by using an anion-exchanger gel combined with an FIA system. *Analytical Sciences*, Vol. 17, No. 8, (August 2001), pp. 1007–1010, ISSN: 0910-6340
- Ruedas-Rama, M.J., Ruiz-Medina, A. & Molina-Díaz, A. (2002). Use of a solid sensing zone implemented with unsegmented flow analysis for simultaneous determination of thiabendazole and warfarin. *Analytica Chimica Acta*, Vol. 459, No. 2, (May 2002), pp. 235–243, ISSN: 0003-2670
- Ruzicka, J. & Hansen, E.H. (1985). Optosensing at active surfaces a new detection principle in flow injection analysis. *Analytica Chimica Acta*, Vol. 173, pp. 3–21, ISSN: 0003-2670
- Salinas-Castillo, A., Fernández-Sánchez, J.F., Segura-Carretero, A. & Fernández-Gutiérrez, A. (2004). A facile flow-through phosphorimetric sensing device for simultaneous determination of naptalam and its metabolite 1-naphthylamine. *Analytica Chimica Acta*, Vol. 522, No. 1, (September 2004), pp. 19–24, ISSN: 0003-2670
- Sánchez-Barragán, I., Karim, K., Costa-Fernández, J.M., Piletsky, S.A. & Sanz-Medel, A. (2007). A molecularly imprinted polymer for carbaryl determination in water. *Sensors and Actuators B*, Vol. 123, No. 2, (May 2007), pp. 798–804, ISSN: 0925-4005
- Soler, C., Mañes, J. & Picó, Y. (2008). The Role of the Liquid Chromatography-Mass Spectrometry in Pesticide Residue Determination in Food. *Critical Reviews in Analytical Chemistry*, Vol. 38, No. 2, (April 2008), pp 93–117, ISSN: 1040-8347
- Traviesa-Álvarez, J.M., Costa-Fernández, J.M., Pereiro, R. & Sanz-Medel, A. (2004). Flow-through solid-phase energy transfer-room temperature phosphorescence for orthophosphate determinations at trace levels. *Talanta*, Vol. 62, No. 4, (March 2004), pp. 827–833, ISSN: 0039-9140
- Valero-Navarro, A., Salinas-Castillo, A., Fernández-Sánchez, J.F., Segura-Carretero, A., Mallavia, R. & Fernández-Gutiérrez, A. (2009a). The development of a MIP-optosensor for the detection of monoamine naphthalenes in drinking water. *Biosensors and Bioelectronics*, Vol. 24, No. 7, (March 2009), pp. 2305–2311, ISSN: 0956-5663
- Valero-Navarro, A., Damiani, P.C., Fernández-Sánchez, J.F., Segura-Carretero, A. & Fernández-Gutiérrez, A. (2009b). Chemometric-assisted MIP-optosensing system for the simultaneous determination of monoamine naphthalenes in drinking waters. *Talanta*, Vol. 78, No. 1, (April 2009), pp. 57–65, ISSN: 0039-9140
- Varsamis, D.G., Touloupakis, E., Morlacchi, P., Ghanotakis, D.F., Giardi, M.T. & Cullen, D.C. (2008). Development of a photosystem II-based optical microfluidic sensor for herbicide detection. *Talanta*, Vol. 77, No. 1, (October 2008), pp. 42–47, ISSN: 0039-9140
- Védrine, C., Leclerc, J.C., Durrieu, C. & Tran-Minh, C. (2003). Optical whole-cell biosensor using *Chlorella vulgaris* designed for monitoring herbicides. *Biosensors and Bioelectronics*, Vol. 18, No. 4, (April 2003), pp. 457–463, ISSN: 0956-5663

- Wilkowska, A. & Biziuk, M. (2011). Determination of pesticide residues in food matrices using the QuEChERS methodology. *Food Chemistry*, Vol. 125, No. 3, (April 2011), pp. 803–812, ISSN: 0308-8146
- Wu, J., Tragas, C., Lord, H. & Pawliszyn, J. (2002). Analysis of polar pesticides in water and wine samples by automated in-tube solid-phase microextraction coupled with high-performance liquid chromatography-mass spectrometry. *Journal of Chromatography A*, Vol. 976, No. 1-2, (November 2002), pp. 357–367, ISSN: 0021-9673
- Xavier, M.P., Vallejo, B., Marazuela, M.D., Moreno-Bondi, M.C., Baldini, F. & Falai, A. (2000). Fiber optic monitoring of carbamate pesticides using porous glass with covalently bound chlorophenol red. *Biosensors and Bioelectronics*, Vol. 14, No. 12, (February 2000), pp. 895–905, ISSN: 0956-5663

IntechOpen

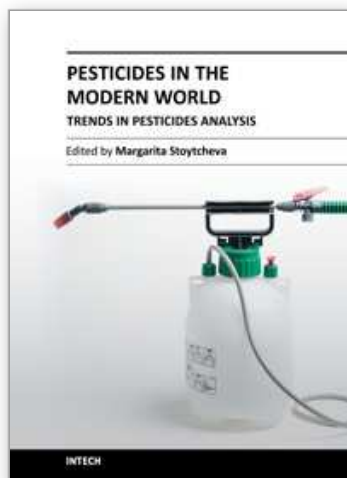

## **Pesticides in the Modern World - Trends in Pesticides Analysis**

Edited by Dr. Margarita Stoytcheva

ISBN 978-953-307-437-5

Hard cover, 514 pages

**Publisher** InTech

**Published online** 21, October, 2011

**Published in print edition** October, 2011

The book offers a professional look on the recent achievements and emerging trends in pesticides analysis, including pesticides identification and characterization. The 20 chapters are organized in three sections. The first book section addresses issues associated with pesticides classification, pesticides properties and environmental risks, and pesticides safe management, and provides a general overview on the advanced chromatographic and sensors- and biosensors-based methods for pesticides determination. The second book section is specially devoted to the chromatographic pesticides quantification, including sample preparation. The basic principles of the modern extraction techniques, such as: accelerated solvent extraction, supercritical fluid extraction, microwave assisted extraction, solid phase extraction, solid phase microextraction, matrix solid phase dispersion extraction, cloud point extraction, and QuEChERS are comprehensively described and critically evaluated. The third book section describes some alternative analytical approaches to the conventional methods of pesticides determination. These include voltammetric techniques making use of electrochemical sensors and biosensors, and solid-phase spectrometry combined with flow-injection analysis applying flow-based optosensors.

### **How to reference**

In order to correctly reference this scholarly work, feel free to copy and paste the following:

Maria Luisa Fernández-de Córdova and Pilar Ortega-Barrales (2011). The Potential of Flow-Based Optosensing Devices for Pesticide Assessment, *Pesticides in the Modern World - Trends in Pesticides Analysis*, Dr. Margarita Stoytcheva (Ed.), ISBN: 978-953-307-437-5, InTech, Available from: <http://www.intechopen.com/books/pesticides-in-the-modern-world-trends-in-pesticides-analysis/the-potential-of-flow-based-optosensing-devices-for-pesticide-assessment>

**INTECH**  
open science | open minds

### **InTech Europe**

University Campus STeP Ri  
Slavka Krautzeka 83/A  
51000 Rijeka, Croatia  
Phone: +385 (51) 770 447  
Fax: +385 (51) 686 166  
[www.intechopen.com](http://www.intechopen.com)

### **InTech China**

Unit 405, Office Block, Hotel Equatorial Shanghai  
No.65, Yan An Road (West), Shanghai, 200040, China  
中国上海市延安西路65号上海国际贵都大饭店办公楼405单元  
Phone: +86-21-62489820  
Fax: +86-21-62489821

© 2011 The Author(s). Licensee IntechOpen. This is an open access article distributed under the terms of the [Creative Commons Attribution 3.0 License](#), which permits unrestricted use, distribution, and reproduction in any medium, provided the original work is properly cited.

IntechOpen

IntechOpen