

We are IntechOpen, the world's leading publisher of Open Access books Built by scientists, for scientists

5,500

Open access books available

135,000

International authors and editors

165M

Downloads

Our authors are among the

154

Countries delivered to

TOP 1%

most cited scientists

12.2%

Contributors from top 500 universities



WEB OF SCIENCE™

Selection of our books indexed in the Book Citation Index
in Web of Science™ Core Collection (BKCI)

Interested in publishing with us?
Contact book.department@intechopen.com

Numbers displayed above are based on latest data collected.
For more information visit www.intechopen.com



Holography – What is It About?

Dagmar Senderakova
Comenius University in Bratislava,
Slovakia

1. Introduction

The 21st century is said to be a photon-century. People meet contemporary optics (holography, as well) applications everywhere. It would be appropriate to increase the common education level in this field for people to be able to understand new surrounding technologies, entering our everyday lives. Optics serves as an important part of many scientific experimental methods. This way, such information could be useful also for researchers without a professional optical education.

Let us follow, briefly, at least, the history of a “mystery of light”. Light surrounds people from the very beginning. Man lives in the world bathing in light. The eye is said to bring us the greatest piece of information. Naturally, people have been taken an interest in that “something”, useful for our eyes, called light. Thousands of years after human started with using fire to illuminate nights (~ 12000 BC), Indians, Greek and Arab scholars began to formulate theories on light (Davidson, 1995). Man had been taken a great interest in “optical experiments”. Even in 423 BC, Aristophanes wrote a comedy, *Clouds*, in which an object was used to reflect and concentrate the sun’s rays and to melt an IOU recorded on a wax table (Stevenson, 1994).

For now, let us briefly mention only some steps, dealing with the original question: “*What is light?*” Such a question is closely related to the answer – “*How can man see?*” So-called “tactile theory” seemed to be the first one that gave an answer. It was based on the assumption that the human eye sent out invisible probes/light rays “to feel” objects (Plato, Euclid, 400-300 BC).

However, people cannot see in dark! Aristotle (350 BC) was among the first to reject such a theory of vision. He advocated for a theory by which the eye received rays rather than directed them outward. Such a theory, so-called “*emission theory*”, appeared later and offered a solution of the paradox, mentioned above. It stated that bright objects sent out beam of particles into the eye.

More than 17 centuries passed, while experiments with light, mirrors and lenses had led to construction of microscopes and telescopes, which broaden the worldview of early scientists. As for the character of light, Ch. Huygens was able to explain many of the known propagation characteristics of light, using his *wave* theory. He assumed light to transmit through all-pervading ether that is made up of small elastic particles, each of which can act as a secondary source of wavelets. However, he could not explain such a simple thing, like rectilinear propagation of light...

The development culminated in 1704, when I. Newton published his *Optiks* and advocated his *corpuscular theory*: *Light is a system of tiny particles that are emitted in all directions from a*

source in straight lines. The corpuscles are able to excite waves in ether. Light slows when entering a dense medium. This theory is used to describe reflection. However, it cannot explain some atmospheric phenomena, like supernumerary bow, the corona, or an iridescent cloud.

In about 100 years later, the Newton's corpuscular theory was overturned by *the wave theory* when demonstrating and explaining phenomena of interference, diffraction and polarisation of light (T. Young, A. J. Fresnel, D. F. Arago, J. Fraunhofer).

Then a new era began. The discovery of electromagnetic waves is considered perhaps, the greatest theoretical achievement of physics in the 19th century. Besides, the speed of light had been known to be about 300 000 km/s, since the 17th century (Olaus Roemer, a Danish astronomer).

James Clerk Maxwell (1831-79) completed his formulation of the field equations of electromagnetism to be applicable also for space without wires. Moreover, he calculated that the speed of propagation of an electromagnetic field is approximately that of the speed of light. Because of that he proposed the phenomenon of light to be an electromagnetic phenomenon. This way, Maxwell established the theoretical understanding of light.

In the late 19th century it was believed that all the electromagnetic phenomena could be explained by means of this theory. However, an unexpected problem arose when one tried to understand the radiation from glowing matter like the sun, for example. The spectral distribution did not agree with the theories based on Maxwell's work. There should be much more violet and ultraviolet radiation from the sun than had actually been observed.

Max Planck came with a solution. Being skilled in mathematics, he played around with the equations and introduced mathematically, only, the idea of energy quantum $h\nu$, where $h = 6.626 \times 10^{-34}$ Js is now called Planck's constant. He assumed that for a wave with a certain frequency ν , it was only possible to have energies that were multiples of $h\nu$. Such a math trick caused the new calculation to agree with experiment perfectly but nobody really believed that light came in "particles".

Time went and showed that energy could only come in small "parcels" of $h\nu$. These small parcels of light were called *quanta*. Einstein liked the idea of quanta and supported their existence explaining *photoelectric effect* and describing light-matter interaction via *absorption and spontaneous and stimulated emission*, which initiated birth of a new kind of a light source – *laser (Light Amplification by Stimulated Emission of Radiation)*.

Einstein extended the *quantum theory* of thermal radiation proposed by Max Planck to cover not only vibrations of the source of radiation but also vibrations of the radiation itself.

As for photon – let's mention something interesting. Einstein did not introduce the word photon. It originated from Gilbert N. Lewis, years after Einstein's works on photoelectric effect. He wrote a letter to the Nature magazine editor (Levis, 1926): "...I therefore take the liberty of proposing for this hypothetical new atom, which is not light but plays an essential part in every process of radiation, the name *photon*...." Interestingly, Lewis did not consider photons as light or radiant energy but as the carriers of radiant energy.

The quantum theory also met with difficulties. Solving them, quantum electrodynamics (QED), was developed (Nobel Prize in Physics 1965 to S. Tomonaga, J. Schwinger and R. P. Feynman). It became the most precise theory in physics and contributed especially to development of particle physics. However, in the beginning it was not judged necessary to apply QED to visible light.

Later, it was just the development of lasers, sources of *coherent* light and similar devices, which caused a more realistic description to be required when considering the light from a

thermal source (light bulb, sun, and so on) comparing with that of laser. Their light waves seemed to be much more chaotic and it seemed easier to describe the disorder that stemmed from it as randomly distributed photons.

One half of the 2005-year's Nobel Prize in Physics was awarded to Roy J. Glauber for his pioneering work in applying quantum physics to optical phenomena. He had developed a method for using electromagnetic quantization to understand optical observations. He carried out a consistent description of photoelectric detection with the aid of quantum field theory, which laid the foundations for the new field of *Quantum Optics*. It soon became evident that technical developments made it necessary to use the new quantum description of the phenomena, too. Man can get completely new technical applications of quantum phenomena, for example to enable safe encryption of messages within communication technology and information processing.

Let us remember that light still is the same light, despite speaking about particles, waves, quanta, and so on. In physics, we are trying to describe and explain our observations. Moreover, after having understood the observed phenomenon, we would like to predict another phenomenon and prove it experimentally. To do that, we have to use a "language". It is math. We can use math to describe behaviour of material objects, waves and various kinds of energy. Taking into account the experience, man uses the known "items" to create a model of the observing object – light in our case. Just that is the origin of all the wave models of light, mentioned above. There are optical phenomena (e. g. reflection and refraction of light) explained easily to compare them to the behaviour of mechanical corpuscles or rays. To explain phenomena of interference, diffraction and polarisation of light, the model of waves has to be considered. *Photons*, seem to be very useful to explain absorption and scattering of light, photoelectric effect in a simply way, and so on.

2. Wave aspects of light

Taking into account the main goal of the chapter – to understand the new and attention catching problem of holographic recording, let us get more familiar with the wave model of light. Namely, making a hologram means to deal with interference of light. To see, what is the hologram about, we need diffraction of light, in fact. Both the phenomena are usually described using the math language for waves.

2.1 Wave

In physics, a wave is defined to be a process of disturbance travelling throughout a medium. How is it performed, it depends on the kind of disturbance and on the medium-disturbance coupling. Wave transfers energy from one particle of medium to another one without causing a permanent displacement of the medium itself.

Let us have a look at a light wave, being modelled by an electromagnetic wave. It is enough to deal with the electric wave. The magnetic one is related to it by Maxwell's equations. Conventionally, amplitude of electric field vector f can be expressed in the form

$$f = A \cdot \cos \phi \quad (1)$$

The peak value A of the alternating quantity f is called *amplitude*. The sign ϕ denotes phase of the wave. It determines development of the periodic wave. Let us have a wave propagating in direction z . It varies in both, space (z) and time (t), which are included just in the phase

$$\phi = \omega t - kz + \phi_0 \quad (2)$$

ϕ_0 is the initial phase of the wave at $z = 0$ and $t = 0$. $k = 2\pi/\lambda$ defines *wave number*. It is the absolute value of *wave vector* k determining direction of wave propagation. The distance between the two neighbouring amplitude peaks of the same kind is *wavelength* λ [m]. ω [rad.s⁻¹], is *angular frequency*, which is related to the linear *frequency*, ν [s⁻¹], by the formula $\omega = 2\pi\nu$. It lasts $T = \lambda/c$ seconds to pass the path λ at the speed c . Such a time interval is called *period* and $T = 1/\nu$.

A *wave front* is another useful term for us, else. It is the surface upon which the wave has equal phase. It usually represents the peak amplitude of the wave and is perpendicular to the direction of propagation, i.e. to the wave vector k . Wave fronts related to the same phase are separated by the wavelength.

Considering a wave propagating in the $+z$ direction, the wave vector k is parallel to the z -axis everywhere. Because of that, wave fronts are parallel planes, perpendicular to the z -axis. Such a wave is known as a *plane wave*. When the $k(k_x, k_y, k_z)$ direction is general, the phase (2) in a point determined by a displacement vector $r(x, y, z)$ includes the scalar product of $k \cdot r$ instead of kz .

Let us mention also a *spherical wave*

$$f(r, t) = \frac{A}{r} \cos(\omega t - kr + \phi_0) \quad (3)$$

which is irradiated from a point light source in homogeneous medium. In such a case wave fronts are centrally symmetrical spheres, so it is enough to consider only radial coordinate r of *spherical* ones. Moreover, k and r are parallel, so $k \cdot r = kr$. Increasing distance from the source the surface of the sphere increases and amplitude A decreases proportionally to $1/r$.

We are going to work with waves in this topic and it has been known that using trigonometric functions leads to cumbersome calculations. To overcome such a problem, a complex notation is used. The trigonometric function can be replaced by exponential functions applying Euler's formula

$$e^{i\phi} = \cos\phi + i\sin\phi \quad e^{-i\phi} = \cos\phi - i\sin\phi = (e^{i\phi})^* \quad (4)$$

Such a way will simplify the mathematical description of light greatly. $e^{i\phi}$ is a complex function, $\cos\phi$ is its real part, $\sin\phi$ is its imaginary part and i is imaginary unit. $(e^{i\phi})^*$ is said to be a complex conjugate function to $e^{i\phi}$. From such a point of view the expression (1) can be considered as a real part of the complex function

$$f = Ae^{i\phi} = A\cos\phi + iA\sin\phi \quad (5)$$

When comparing to mechanics and electricity, there is a special property of light waves. The instantaneous amplitude f , which varies with both, time and space, cannot be measured experimentally in a direct way. The frequency of the *light wave* is too high for any known physical mechanism (photo electrical effect) to reply to the changes of the instantaneous amplitude f .

Any known detector replies only to the incident energy. When denoting energy transferred by a wave as w , it can be got as square of the amplitude, e.g. $w = A^2 = f \cdot f^*$, when using the complex representation. The value known as *intensity* I of light, is proportional to the energy per unit of surface and unit of time. It is very important to realise that the time averaged

light intensity is a measurable value, only. Because of that it is said that both, light detection and light recording are *quadratic*.

Before starting with the basic phenomena of *interference* and *diffraction* of light, remember the simple wave model, describing the propagation of light wave through a space, else. The Dutch physicist Christian Huygens formulated a principle. It says that *each point on the leading wave front may be regarded as a secondary source of spherical waves, which themselves progress with the speed of light in the medium and whose envelope constitutes the new wave front later. The new wave front is tangent to each wavelet at a single point.*

2.2 Interference of light

Let us add two waves, i.e. illuminate a surface by two light beams. The observable result depends on what light beams were used. Mostly, one can observe a brighter surface comparing to that illuminated by one-beam, only. However, there are situations, when one can see both, parts of the surface with very high brightness, and parts with very low one, even dark. Just that case, when a kind of redistribution of all the incident energy can be observed, represents what is said to be the *interference of light*. Let us find what is the reason of such a redistribution of light energy when overlapping two light beams.

In the beginning, let us consider two light waves, f_1 and f_2 , expressed by (5)

$$f_1 = A_1 \exp(i\phi_1) \quad \text{and} \quad f_2 = A_2 \exp(i\phi_2) \quad (6)$$

They can meet at a time at every point of the surface with a phase difference $\Delta\phi = \phi_2 - \phi_1$. Let us find what can be observed. Taking into account quadratic detection of light, the result can be expressed by

$$\langle I \rangle = \langle (f_1 + f_2)(f_1 + f_2)^* \rangle = \langle |A_1|^2 + |A_2|^2 + 2A_1A_2 \cos(\phi_2 - \phi_1) \rangle \quad (7)$$

Brackets $\langle \rangle$ represent time averaged light intensity I , $|A_i|^2 = I_i$ denote intensities of each of two waves.

Let us have a more detailed look at the phase difference $\Delta\phi = \phi_2 - \phi_1$. Taking into account the relation (2), the phase difference can be expressed in the form

$$\Delta\phi = \phi_2 - \phi_1 = (\omega_2 t - k_2 z_2 + \phi_{02}) - (\omega_1 t - k_1 z_1 + \phi_{01}) \quad (8)$$

It is obvious that the time independence of the phase difference in (7) is the crucial condition to get interference of light, i.e. to observe and record energy distribution following the phase difference at any point of the surface. The conditions, being necessary to be fulfilled, follow from (8): $\omega_1 = \omega_2$, i.e. $\lambda_1 = \lambda_2$ and $\phi_{01} = \phi_{02}$. Such two waves are said to be *coherent* and only in such a case the intensity distribution (7) can be observed and recorded. Both the waves must have the same properties, i.e. the same wavelength, the same initial phases. Both waves have to come from one coherent light source. It is *laser*, where *stimulated emission* (Smith et al., 2007) takes part.

Relation (7) can be used to find the well-known conditions when either maximum or minimum of average intensity occurs:

$$\langle I \rangle = I_{\max} \quad \text{when} \quad \Delta\phi = 2m\pi \quad \text{i.e.} \quad n\Delta l = m\lambda, \quad m = 0, 1, 2, \dots \quad (9a)$$

$$\langle I \rangle = I_{\min} \quad \text{when} \quad \Delta\phi = (2m + 1)\frac{\pi}{2} \quad \text{i.e.} \quad n\Delta l = (2m + 1)\frac{\lambda}{2} \quad m = 0, 1, 2, \dots \quad (9b)$$

Product of index of refraction n and path difference Δl , which can be found in the phase difference, is known as *optical path difference*. Namely, $\Delta\phi = (2\pi/\lambda)n\Delta l$, when $\omega_1 = \omega_2$, and $\phi_{01} = \phi_{02}$. The wavelength λ is taken in vacuum.

On the contrary, when the phase difference between two being added light waves is time dependent, the last term in (7) turns into zero. The average intensity distribution does not depend on the phase difference and no intensity distribution is observed, no interference occurs. Such two waves are said to be *incoherent*. However, real waves are *partially coherent*.

Concluding this part, let us give some notices dealing with *coherence*. Generally, it is defined by the correlation properties between quantities of an optical field. Interference is the simplest phenomenon revealing correlations between light waves. A *complex degree of mutual coherence* $\gamma_{12}(\tau)$ is defined to express the coherence of an optical field (Smith et al., 2007). Numbers 1 and 2 denote two point sources of interfering waves, and τ represents their relative delay. It can be shown that the interference pattern (7) is influenced by *module of degree of mutual coherence* $|\gamma_{12}(\tau)|$

$$\langle I \rangle \sim I_1 + I_2 + 2\sqrt{I_1 I_2} |\gamma_{12}(\tau)| \cos(\phi_2 - \phi_1) \quad (10)$$

In another words, *visibility* $V = (I_{\max} - I_{\min}) / (I_{\max} + I_{\min})$ of interference pattern, which can be measured experimentally (Fig. 1), tells us about the *module of degree of mutual coherence* $|\gamma_{12}(\tau)|$

$$V_{12}(\tau) = \frac{I_{\max} - I_{\min}}{I_{\max} + I_{\min}} = 2|\gamma_{12}(\tau)| \left[\sqrt{\frac{I_1}{I_2}} + \sqrt{\frac{I_2}{I_1}} \right]^{-1} \quad (11)$$

A practical measurement of the degree of coherence amounts to creating an interference pattern between two waves (1, 2), or of a wave with itself. Temporal $V_{11}(\tau)$ and spatial $V_{12}(0)$ dependencies can be obtained experimentally by varying either the delay τ using a moving mirror in an interferometer or keeping $\tau = 0$ and varying the distance between the point sources 1 and 2.

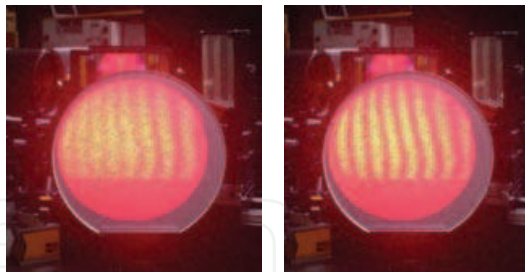

Fig. 1. Various visibility of interference pattern

This way either normalised Fourier transform of the frequency spectrum irradiated (related to the *temporal coherence*) or normalised Fourier transform of angular intensity distribution (related to the *spatial coherence*) can be obtained experimentally.

In the case of equal average intensities of both the waves, the module of the complex degree of coherence is given directly by the visibility V of the interference pattern.

2.3 Diffraction of light

Diffraction has been known as another phenomena of wave optics. Any deviation from rectilinear propagation of light that cannot be explained because of reflection or refraction is included into diffraction. When light passes through a narrow slit, it seems as it “bends”

and incidents on the screen behind the slit also where darkness was expected to be according a geometric construction. Moreover, it is not a continuous illumination. Some fringes can be seen.

In fact, it is a result of interference of light, again. Let us have a look at what happens. For simplicity, a coherent plane wave, incident perpendicularly at the plane of the slit, passes the slit (Fig. 2.). The part of wave front restricted by the slit contains infinite number of point light sources having the same phase. Imagine the sources as divided into two equal groups – the sources above and under the z -axis. Infinite number of couples S_1 and S_2 just distant $b/2$ (half of the slit width) from each other can be found in the slit. Let us consider only light propagating at the same angle α from both the sources. Interference should occur very far away, at $L = \infty$, and can be observed in the second focus plane of a lens.

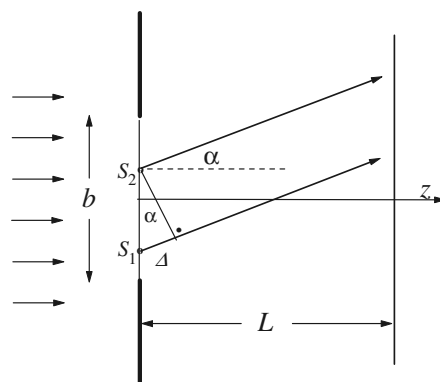

Fig. 2. Light passes through a slit (width of the slit is denoted by b)

Let us calculate the path difference Δl (Δ in Fig. 2) between interfering waves. It is given by the angle α and the slit width b

$$\Delta l = \frac{b}{2} \sin \alpha \quad (12)$$

Relations (9a) and (9b) determine angles α at which either interference maxima (constructive interference) or minima (destructive interference) occur.

The same analysis can be used for any such a pair of point light sources from the slit. It will increase the amount of energy propagating at the angle α .

The average relative intensity distribution (Fig. 3) relation

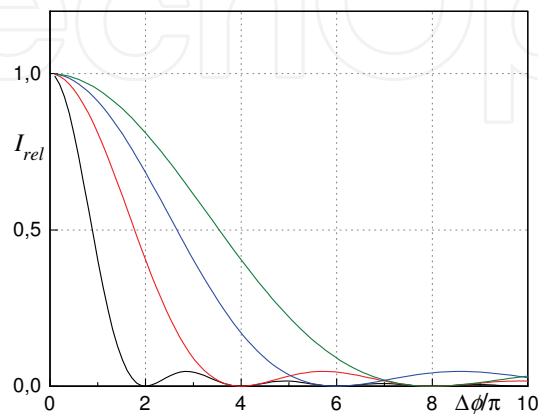

Fig. 3. Diffraction pattern at various slit widths ($\Delta\phi / \pi = (b/\lambda)\sin\alpha$, $b > b > b > b$)

$$\frac{I(\alpha, \lambda, b)}{I_0} = \left[\frac{\sin\left(k \frac{b}{2} \sin \alpha\right)}{k \frac{b}{2} \sin \alpha} \right]^2 \quad (13)$$

can be found analytically, applying the scalar diffraction theory (Smith et al., 2007). Practically usable are especially the conditions for interference minima

$$b \cdot \sin \alpha = m \lambda, \quad m = 1, 2, 3, \dots \quad (14)$$

Most of the light energy (~84%), which passed through the slit, is concentrated near the axis. It is called the zero order maximum. The apex angle 2α of this cone depends on the slit width and wavelengths of the used light

$$b \cdot \sin \alpha = 1 \cdot \lambda \Rightarrow \sin \alpha = \lambda / b \quad (15)$$

It can be seen from the relation (15) - the less is b , the greater is $\sin \alpha$ and the greater is the angle α .

Practically, it is worth to notice that diffraction by a circular aperture is very important. Why is it? All the optical devices, like cameras, and so on, restrict the passing light by a circular aperture. The relation, similar to the (14) one, has the form (Smith et al., 2007)

$$\sin \alpha = 1.22 (\lambda / D) \quad (16)$$

where D is the diameter of the aperture.

Let us notice another kind of diffraction, else, widely used, especially in spectroscopy (looking for various wavelengths) - *diffraction by a grating*. The grating is an ensemble of single equal slits, parallel to each other and having the same distance between each other. There are two parameters, which define the grating - the slit width (b) and the grating interval (d) - distance between centres of any two adjacent slits (Fig. 4.).

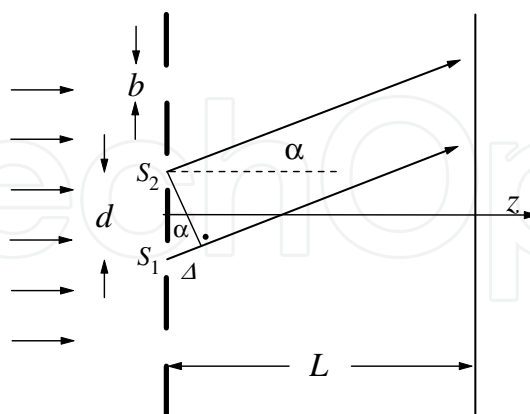

Fig. 4. Diffraction by a grating (d - grating interval, b - slit width)

It is the interference of many "diffractions" by single slits, in fact. The number of interfering "diffractions" depends on the number of illuminated slits. To explain the result, in a simply way we can use the analysis above when considering the single slit only. However, now any slit is considered to represent a single light source with the same phase.

Following the consideration above and the relation (12), the path difference between waves from two neighbouring sources (slits), propagating at an angle α can be expressed in the form

$$\Delta l = d \cdot \sin \alpha \quad (17)$$

Let us compare the relations for a single slit (12) and for a grating (17). Since d is defined to be the distance between two related points, e.g. the centres of two neighbouring slits, certainly $d > b/2$. Compare the angles for the single slit α_s and for the grating α_g , when destructive interference appears the first time, i.e. when $m = 1$ in (9b), we realize that

$$\sin \alpha_s = \lambda / b \quad \sin \alpha_g = \lambda / 2d \Rightarrow \alpha_s > \alpha_g \quad (18)$$

Relation (18) tells us that the destructive interference with the grating occurs at the less angle α_g than in case of one of grating slits (α_s). Because of that some intensity maxima can occur in the frame of the zero order maximum of a single slit (Fig. 5.). The number of intensity maxima $m = d/b$ can be found in an easy way (Smith et al., 2007) using relations (18).

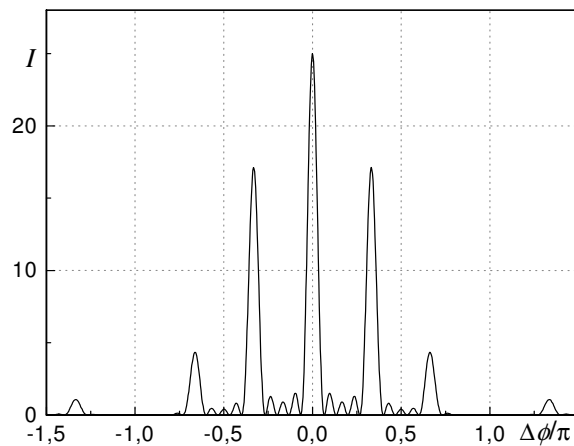

Fig. 5. Intensity distribution for $d/b = 3$, $\Delta\phi / \pi = (d/\lambda)\sin\alpha$

Let us also have a note to the influence of number of illuminated slits on the grating diffraction pattern (another name for the interference intensity distribution). It is related to many-beam interference (Smith et al., 2007). The more slits, the more beams and the highest and narrowest the intensity maximum. Of course, the values of all the intensity maxima are not equal. They are modulated by diffraction by the single slit.

The average relative intensity distribution relation can be found in the form (Smith et al., 2007)

$$\frac{I(\alpha, \lambda, b, d)}{I_0} = \left[\frac{\sin\left(k \frac{b}{2} \sin \alpha\right)}{k \frac{b}{2} \sin \alpha} \right]^2 \left[\frac{\sin\left(kN \frac{d}{2} \sin \alpha\right)}{\sin\left(k \frac{d}{2} \sin \alpha\right)} \right]^2 \quad (19)$$

Practically usable is especially the condition for interference maxima

$$d \cdot \sin \alpha_m = m\lambda, \quad m = 0, 1, 2, 3, \dots \quad (20)$$

Concluding, let us mention the main principle of solving diffraction problems briefly, at least. Exact solutions are given by solving Maxwell's equations. However, well-known Kirchhoff's scalar theory gives very good results if period of diffraction structure does not approach a wavelengths size and amplitude vector does not leave a plane.

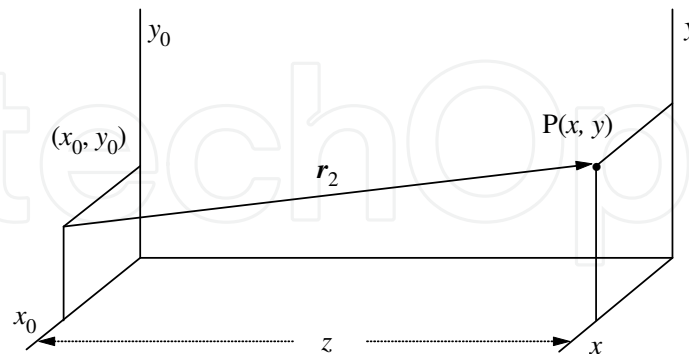

Fig. 6. To the principle to solve scalar diffraction problems

Let the plane (x_0, y_0) is the plane of the slit and diffraction is observed in the plane (x, y) . To find resulting amplitude in $P(x, y)$, amplitudes of spherical waves from all the point sources in the plane of the slit have to be summed (Fig. 6). The idea is expressed by Kirchhoff's diffraction integral

$$f_P(x, y, z) \sim \iint_S \frac{f_P(x_0, y_0)}{r_2} \exp\{-ikr_2\} dx_0 dy_0 \quad (21)$$

where the distance $r_2 = [(x - x_0)^2 + (y - y_0)^2 + z^2]^{1/2}$ and S is size of the obstacle (slit). The experimentally observable interference pattern is given by $I(x, y, z) \sim f_P(x, y, z) \cdot [f_P(x, y, z)]^*$. To calculate the integral (21), two approximations for r_2 are used.

1. Fresnel diffraction

$x - x_0 \ll z, \quad y - y_0 \ll z$, i.e. next transformations are used

$|r_2| = [z^2 + (x - x_0)^2 + (y - y_0)^2]^{1/2} \rightarrow z + (x - x_0)^2 / 2z + (y - y_0)^2 / 2z$ – in the phase

$|r_2| = z$ – to express amplitude decreasing

In paraxial approximation ($k_x, k_y \ll k_z$) integral (21) turns into

$$f_P(x, y, z) = \frac{i}{\lambda z} \exp(-ikz) \iint_S f_0(x_0, y_0, 0) \exp\left\{-\frac{ik}{2z} [(x - x_0)^2 + (y - y_0)^2]\right\} dx_0 dy_0 \quad (22)$$

2. Fraunhofer diffraction

$x_0, y_0 \ll z$, i.e. next mathematical approximation is used to express the phase

$$(x - x_0)^2 \rightarrow x^2 - 2xx_0 \quad \text{and} \quad (y - y_0)^2 \rightarrow y^2 - 2yy_0$$

and integral (21) turns into

$$f_P(x, y, z) = \frac{i}{\lambda z} \exp\left\{-ik\left(z + \frac{x^2 + y^2}{2z}\right)\right\} \iint_S f_0(x_0, y_0, 0) \frac{\exp\{-ik(xx_0 + yy_0)\}}{z} dx_0 dy_0 \quad (23)$$

Just that is the approximation useful while explaining the basics of holography. Real calculation of integral (23) gives relations (13) and (19).

3. Holography

After invention of coherent light sources – *lasers*, a new method, called *holography*, has been talking about. Basically, it is said to be a new method utilising light to record information. All of us have known a method using light to record information. It is photography. Both methods are kinds of optical recording. Why do we speak about holography? Is there something else comparing to photography?

All of you certainly enjoyed nice photos, marvellous pictures, which either remembered you of something pleasant or showed you something interesting, you have never seen before. Despite the plain shape of a photo, we are able to see and perceive a space on it. However, such ability of perceiving is only a consequence of our everyday experience of perspective. We are able to perceive depth of surrounding space since we have two eyes separated by a distance horizontally. Each eye sees an object in front of us from a bit different direction. The images created by the eye lenses differ a bit and thankful to sophisticated and still not completely understood “image processing” by our brain, we perceive a space. However, “3D impression” of photos can be exalted by stereo photography. In such a case we prepare for each of our eyes a special image, as it was in reality.

On the other side, when observing a hologram, one does not need to be experienced in anything. Simply, it is a 3D scene, indeed. Moving your head a bit allows you reveal even hidden objects when observing the hologram. What is the reason of such differences? To make a record, light was used each time.

The secret is encoded in the name *hologram*, in fact. The name was coined by British scientist Dennis Gabor (native of Hungary), who developed the theory of holography while dealing with the problem “how to improve resolution of an electron microscope”. It comes from two Greek words *holos* (whole) and *gramma/graphie* (message/recording).

Such an origin gives a hint about recording “everything” of the light coming from the object. Another notice – do we not record light in whole when taking a picture by a photo-camera? What does it mean “in whole” and “not in whole”?

Let us remember a light wave and its properties (1). When expressing it, some attributes are included: *amplitude* and *phase*. Moreover, remember, again – the light wave cannot be recorded directly. Only the energy transferred by a wave, $w = |A|^2$, is a measurable and detectable value.

Just that is used when taking a classical picture. Optical system of a camera produces the image of every point of the object on the recording plane, where film/pixels are placed and influenced by incident light. That means – only information dealing with amplitude of the light wave was recorded and used to produce a record. The phase (2)

$$\phi = \omega t - kz + \phi_0$$

in which there is the variable z , telling us about the path of the light wave, i.e. from which distance the wave came, is lost. And just there is information about 3D properties of the object hidden. Light waves come to the recording medium with different phases (since passing different paths) from different points of the object.

However, a light wave cannot be recorded directly. In other words – the phase of the wave cannot be recorded directly, too. Only average intensity, proportional to energy transferred by the wave can be recorded. What is a solution?

3.1 Hologram recording

In 1947 Dennis Gabor found the solution. Since average light intensity can be recorded only, nothing about the phase when the light wave is alone can be recorded. On the other hand, when adding two coherent waves, the resulting intensity at any point depends on the phase difference between two waves at that point. We can record an intensity distribution – *interference pattern*, as mentioned in the part 2.

This way it is possible, as is shown later, to get from a hologram the same light wave as propagated from the 3D object, so the 3D object can be observed, indeed.

So the first phenomenon as the principle of the holography is *interference* of light waves. That demands coherent light waves. The simplest way how to get coherent light is – to use laser.

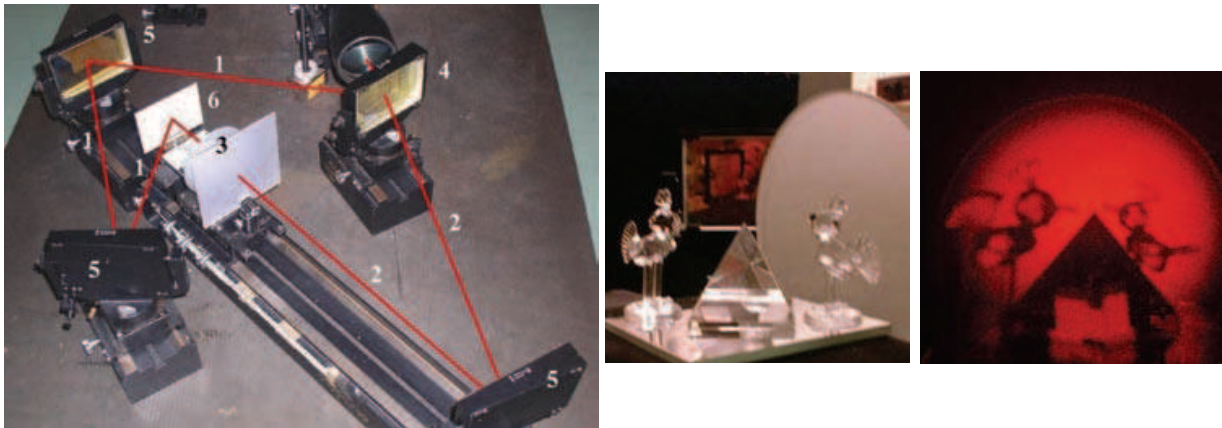

Fig. 7. Hologram recording set-up, object (a glass scene on a mirror), and reconstruction (1–reference wave, 2–wave to create the object wave, 3–object, 4–beam splitter, 5–mirrors, 6–recording medium)

Fig. 7 demonstrates the experimental set-up to record a hologram. Beam splitter 4 divides the laser beam into two parts. The wave 1 proceeds without any changes towards the recording medium 6. There is no information in this wave. It is the *reference wave* (r). Mostly, a plane wave is used, in our set-up too, but it is not a necessity. The wave 2 interacts with the object and *object wave* (o) is created. It is reflected or scattered by the object. It also can pass through the object. It depends on what kind of object we have. In our case the object is transparent, it is a glass scene on a mirror. Collimated laser beam scattered by ground glass and passing through the pyramid and birds represents the object wave.

Reference wave and object wave are directed by mirrors 5, meet each other and interfere in space, where the recording medium 6 is placed. The interference pattern is recorded. To get a hologram, the recording medium is exposed by incident beams and properly processed.

Besides coherent light, there are another experimental conditions else, which have to be fulfilled. All the set-up has to be stable. The path difference between interfering waves must not change even in $\lambda/2$. Such a value changes constructive interference into destructive one, intensity maximum changes into minimum and no interference pattern is recorded.

Moreover, a special holographic recording medium has to be used. The interference pattern of high density (of about 1000-3000 lines/mm) is recorded and the medium has to be able to record it. The density of the interference pattern depends on the angle between interfering waves and one can calculate it approximately using the relation (9a).

To find the two-beam interference pattern density along the x -direction, the k_x component of the wave vector \mathbf{k} has to be considered (Fig. 8.) and (9a) gets the form

$$\Delta\phi = \frac{2\pi}{\lambda} (\sin\alpha_1 + \sin\alpha_2)x = 2m\pi$$

The difference Δx between two adjacent maxims can be expressed by the difference

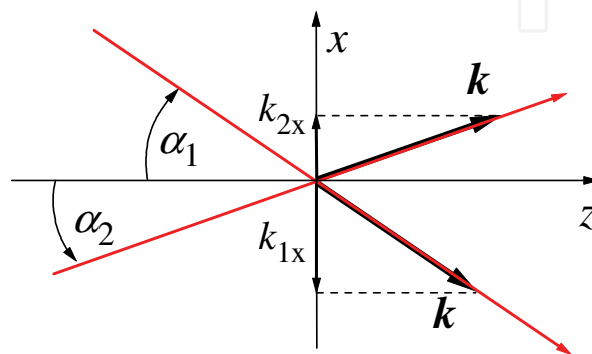

Fig. 8. To get interference pattern density

$$\Delta x = x_m - x_{m+1} = \frac{\lambda}{(\sin\alpha_1 + \sin\alpha_2)} \quad (24)$$

Reciprocal value of (24) gives the *spatial frequency*.

It would be useful to stop for a while at physical meaning of the process of recording. To record light a recording medium is used. It can be any medium, optical properties of which vary with the intensity of incident light. The intensity distribution we would like to record causes similar optical property distribution in the medium. It can be either *transparency* of the recording medium (*amplitude hologram* is made) or its *optical thickness/index of refraction* (a *phase hologram* is made). Which one is relevant depends on the used light, its intensity and the kind of recording medium. The commonly known one is the photographic material. The photographic film gets darker where the original image was lighter. On that case, mostly the transparency of the medium is changed. Bleaching may transform it into a phase hologram.

3.2 Reconstruction of a hologram – what is hidden there?

While recording a hologram, no optical system to create the image of the object was used. This way, after processing the recording medium, nothing can be seen by naked eye. Only a microscope would show us a very tiny interference structure (maxims and minima).

A question arose – how to see what was recorded on the hologram? To understand, it might be better firstly to describe what to do to see what is hidden in the hologram, in another words - to reconstruct its content. Then we shall try to understand why it is this way.

To record a hologram of an object the interference of two waves (object wave and reference one) is recorded. In other words, an interference structure is recorded.

To reconstruct the hologram, certainly it is necessary to illuminate the hologram. That means to illuminate a structure. Now we meet the second important physical phenomenon as the principle of the holography – *diffraction (Fraunhofer's one)* of light reconstructing a hologram.

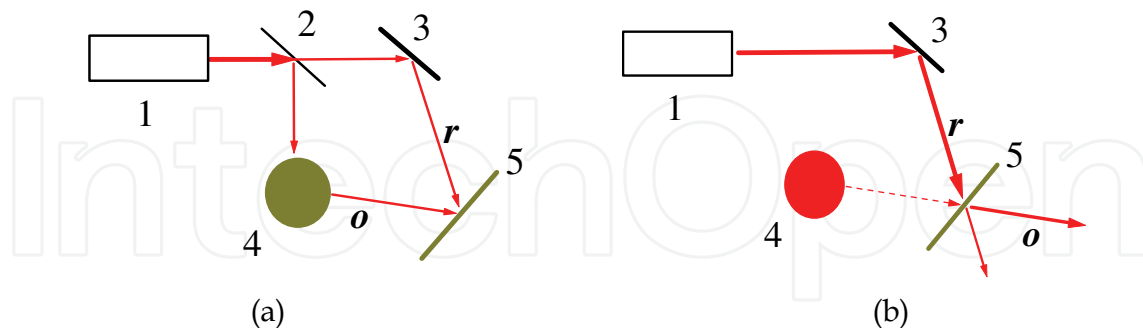

Fig. 9. Recording (a) and reconstruction (b) of a hologram (1-laser, 2-beam splitter, 3-mirror, 4-object, 5-hologram)

Fig. 9 demonstrates recording and reconstruction of a hologram schematically. A hologram had been created by interference of two waves r and o . The interference structure was recorded. When illuminating the structure by one of two waves, which had created it, the second wave appears, too. Naturally, we would like to see which an object had been recorded and illuminate the hologram with the reference wave r . Besides a new wave o appears, which is the same wave as it came from the object, and observer can see the object. Let us try to explain that “miracle” in a simply way.

Huygens’ principle might be the simplest way. When recording a hologram, two waves overlap, interfere and create a resulting wave with special intensity distribution in all the space of overlapping. In one of the planes, the interference pattern is recorded.

When one of the waves creating the hologram (usually the reference one) illuminates the hologram the same intensity distribution as during the hologram recording appears just behind the hologram. We get the same point light sources distribution as during the interference of former object and reference waves. That means, following the Huygens’ principle, – the same waves have to spread from them as before, i.e. the reference wave and the object wave. It is said – the object wave was reconstructed, object can be observed, again. Let us show it a bit more exactly, using the complex notation (5) to express both the waves and the process of recording.

Interference of a reference wave $r = R.exp(i\phi_r)$ and the object wave $o = O.exp(i\phi_o)$ is recorded at a plane recording medium. The resulting amplitude a incident at the recording medium can be expressed by the sum $a = r + o$. Only the intensity $I \sim a.a^*$ can be recorded

$$I \sim (r + o).(r + o)^* = R^2 + O^2 + ro^* + or^* \quad (25)$$

Product of two complex conjugate numbers (like $r.r^*$) gives a real number equal to the square of absolute value of the relevant amplitude (R^2).

For simplicity, let us consider a photographic recording medium. When taking a proper exposure time and processing the medium properly, its *amplitude transparency* t is determined by the intensity (25) (Kreis, 2005). Amplitude transparency is defined as the relation of the amplitude a_t passing through the transparent (our hologram) and the amplitude a , which illuminates the transparent, i.e. $t = a_t/a$. Since dealing with amplitudes of waves, it cannot be measured.

We shall express what happens during reconstruction. The hologram is illuminated by the *reconstructing wave* f . When supposing a thin hologram, the wave f_t just behind the hologram can be expressed in the form

$$f_t = f.t \sim f.I \sim f.(R^2 + O^2) + f.r.o^* + f.o.r^* \quad (26)$$

Relation (26) shows that when illuminating the hologram with the reconstructing wave $f = r$, light field just behind the hologram consists of three parts. To understand the principle, it is not important to deal with all the parts in detail, now. Let us notice the last part, only, which can be expressed in the form

$$f.o.r^* = r.o.r^* = R^2.o \sim o \quad (27)$$

It has been proved exactly in a simply way that the object wave is included into the light field just behind the hologram, when illuminating it with the reference wave. Because of that we can see the object despite being not able to finger it. When using lens terminology, a *virtual image* is reconstructed (Fig. 10b).

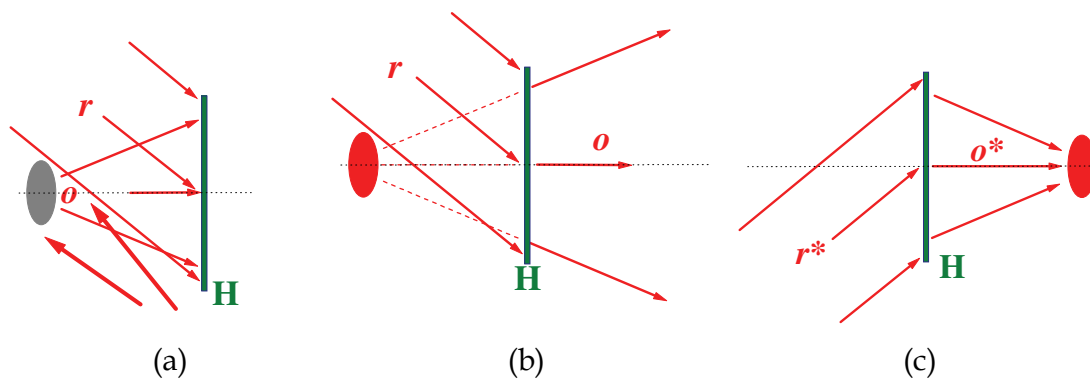

Fig. 10. Hologram recording (a) and reconstruction of virtual (b) and real (c) image

However, when illuminating the hologram with the complex conjugate reference wave $f = r^*$, the second part of (26) gives reconstruction of complex conjugate object wave o^*

$$f.o^*.r = r^*.o^*.r = R^2.o^* \sim o^* \quad (28)$$

Such a reconstructed image (Fig. 10c) can be touched and seen on a screen. A *real image* is reconstructed.

Both, lens and hologram create an image, so hologram is often compared to a lens. So-called *hologram formula*

$$\frac{1}{R_2^{(r,v)}} + \frac{1}{R_1} = \frac{1}{R_1} \left(1 + \frac{\lambda_2}{\lambda_1} \right) - \frac{\lambda_2/\lambda_1}{L_1} \pm \frac{1}{L_2} = \frac{1}{f_H^{(r,v)}} \quad (29)$$

similar to the *lens formula* can be derived, too. A hologram also can be characterised by its *focal length* f_H . It depends on the wavelength of light when either recording (λ_1), or reconstructing (λ_2), object distance from the hologram (R_1) and distance of the source of both, reference (L_1) and reconstructing (L_2) beam from the hologram (Kreis, 2005). Paraxial

approximation is supposed, all the distances are measured perpendicularly to the plane of hologram and indices (signs) r (-), v (+) in (29) are related to real and virtual reconstruction. Concluding, let us mention that when speaking about holography using the language of diffraction, the reconstructed object wave is the diffracted maximum of the first order, created when reference beam is diffracted by the hologram.

3.3 Properties and types of holograms

There are many interesting properties of a hologram. Let us mention some of them. The first three ones, may be considered to be the most important when comparing a hologram to a photograph:

- a. Holography is the only visual recording and playback process that can record our three-dimensional world on a two-dimensional recording medium and “playback” the original object or scene to the unaided eyes as a three dimensional image.

This property follows from what has been said above – the same wave, as propagating from the 3D scene/object while recording the hologram, is reconstructed. We can see the scene/object like through a window in the hologram size.

- b. Excluding few special cases, the original scene or object can be reconstructed from a piece of the hologram, too.

Every point of the illuminated scene/object can be considered as a point light source from which a spherical wave propagates and can cover all recording medium. This way information about any illuminated point of the scene/object can reach all the surface of the recording medium (Fig. 11.).

The more is light scattered by the object the better is information spread over the hologram. However, only a part of hologram cannot be used to reconstruct all recorded object when the object does not scatter light, when light is reflected from a glittering surface. Only a part of hologram cannot be used also in the case of a kind of rainbow holography when a lens is projecting the object at the hologram. However, such a hologram can be reconstructed using white light and it will be told about later.

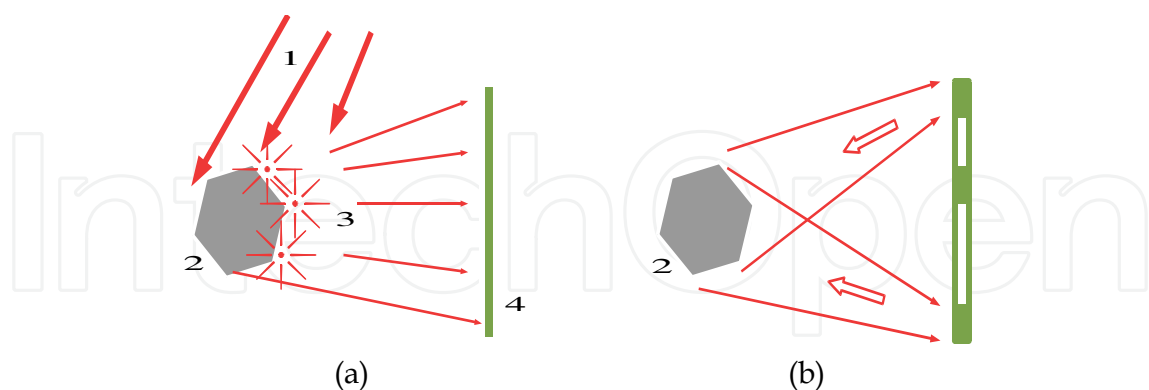

Fig. 11. a) Object wave 3 (set of spherical waves from point sources) of the object 2 surface illuminated by the wave 1; b) Every part of the hologram 4 shows everything

- c. Many records can be made on the same recording medium and they can be reconstructed without interfering each other.

The holographic record is a record of a structure. It can be reconstructed only when proper orientation of the reconstructing (usually reference) beam towards the hologram is chosen. When making more records on the same recording medium, the orientation of the medium

is gradually changed. However, the number of records is limited by the state when all the structures overlap so that they cannot be distinguished.

There are more other terms related to holograms to characterize them, like

- d. *Plane* and *volume* holograms, which differ from each other by the relation between the thickness h of the recording medium and recording density following from relation (24). A hologram is said to be a volume (thick) one, when approximately $h \geq 1.6(\Delta x)^2/\lambda$. Thickness of recording medium decides for example about its storage capacity and possibility to be reconstructed using white light.
- e. *Laser* or *white light* for reconstruction – any hologram can be reconstructed when using laser. However, there are also special holograms, which also can be reconstructed using white light. Some of them can be met daily e.g. at banknotes, and cards.

To understand the item, let us notice the physical meaning of reconstruction – diffraction of reconstructing wave by the “grating” of a hologram. For simplicity, let us consider a hologram like a simple grating with grating constant d and remember the condition (20) for grating m -order interference maximum

$$d \cdot \sin \alpha_m = m\lambda, \quad m = 0, 1, 2, 3, \dots$$

where λ is wavelength and grating constant d is given by the difference between two adjacent interference maxims when the hologram had been recorded (24). When considering reconstruction, $m=1$. For simplicity, the index m is not used later. Since the angle α depends on the wavelength λ various angles $\alpha(\lambda)$ give various positions of the reconstructed object (Fig. 12.) Naturally, it results in “blurred” reconstructed object. However, looking at Fig. 12, it could occurred to us that if an object closer to the recording medium had been recorded, a less blurred reconstruction could have been obtained. There is a possibility to put the recorded object even “into” the recording medium and not to restrict the reference wave while recording the hologram – to *project* it there by a lens/objective. When reconstructing in white light the reconstruction is observed in various (rainbow) colours from various directions at the same place (Fig. 13.).

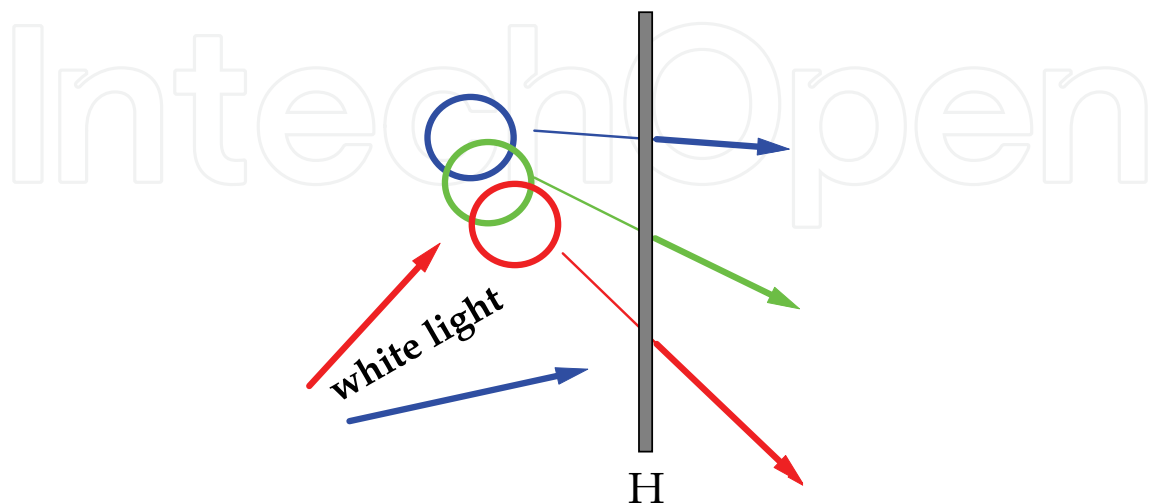

Fig. 12. White light reconstruction

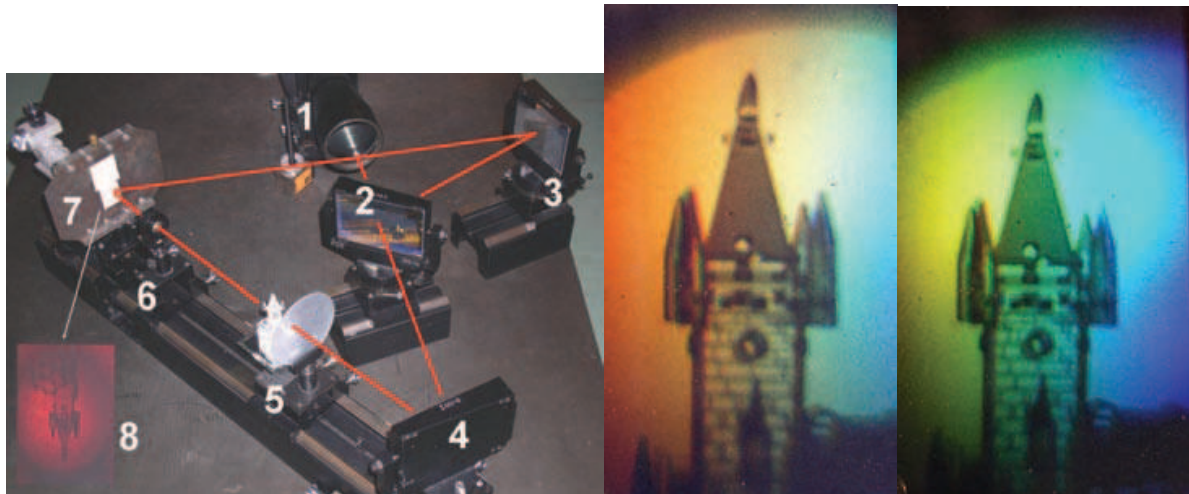

Fig. 13. Experimental set-up and white-light reconstruction of a rainbow hologram with a projecting element (1-from laser, 2-beam splitter, 3 and 4-mirrors, 5-ground glass and object, 6-projecting lens, 7-recording medium, 8-image of the object)

Naturally, projection of a 3D object has 3D properties, too. It is said that a human eye cannot distinguish blurring, caused by the "thickness" of the projection of about 1cm. Because of that, such a simple method is used mostly for approximately "2D" objects (Fig. 14.) - medals, coins, photos, and so on.



Fig. 14. Slovak crown and euro

When a real 3D object is recorded the well-known Benton's method (Benton, 1969), which allows us to get rid of vertical blurring, has to be used. The Benton (rainbow) hologram is a transfer transmission hologram. In fact, it is a hologram of a hologram. The first (master) hologram is masked with a narrow horizontal slit and real reconstruction of its free part serves as an object to record the second hologram with a reference wave diverted from the object one in vertical plane. When viewing such a hologram in white light the colour of the hologram changes and hence the term "rainbow". However, perspective information in vertical axis is lost.

- f. *Fourier* hologram is a holographic record of Fourier image of a 2D object. In its second focal plane the lens 2 creates Fourier image 3 of the object 1, which is placed in the first focal plane of the lens (Fig. 15.). Such a hologram is used mostly in optical information processing.
- g. *Denisjuk's* hologram is another hologram, which can be reconstructed in white light. On the contrary to thin holograms, observable in transmitted light, it belongs to *thick* holograms observable in reflected light.

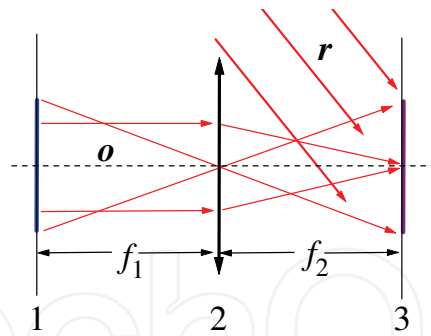

Fig. 15. Fourier hologram

The idea based on Lippman’s colour photography (Denisyuk, 1962), had been elaborated by a Russian physicist Yu. Denisyuk (Fig. 17). After lasers became available Denisyuk developed *volume reflection holography*. Denisyuk’s technique was different in concept and implementation from Gabor’s one. His method could reconstruct three-dimensional holographic images by reflection from the hologram in white light. Denisyuk presented his technique as a generalized form of Lippmann photography, or as a color-dependent optical element. This technique, using reflection holography and the white-light reconstruction technique, seems to be the most promising one as regards the actual recording of colour holograms (Bjelkhagen, H. I. in Ludman et al., 2002).

Considering basic optics it is a kind of a volume grating. Ideally, in such a case only one first-order diffraction maximum is observed, if well-known Bragg’s condition (Kreis, 2005)

$$2dn \cdot \sin\alpha = \lambda \tag{30}$$

connecting the grating constant d , wavelength λ and angle α between incident/reflected beam and plain of grating is fulfilled. Index of refraction of the recording medium is n . In other words – the hologram interference structure can choose a proper reconstructing wavelength from incident white light according its direction and the reconstructed object is observed in monochromatic light.

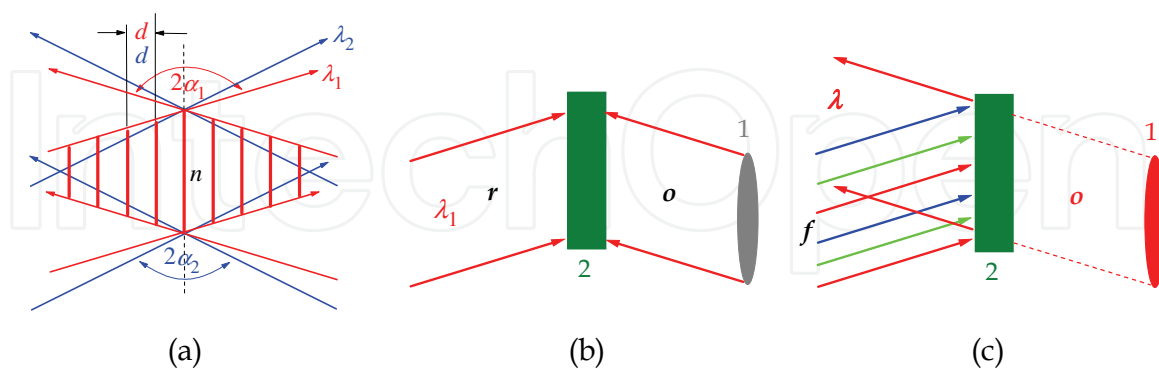

Fig. 16. Thick hologram and white light reconstruction (1-object, 2-hologram)

Fig. 16 shows it schematically. Taking into account relation (24), two coherent plane waves (λ_1) with the angle $2\alpha_1$ between each other, create the interference structure with the grating constant d in medium with index of refraction n

$$d = \lambda_1 / 2n \sin\alpha_1 \tag{31}$$

which is identical with relation (30). When another waves (λ_2), another angle $2\alpha_2$ has to be used to create an interference structure with the same grating constant d (Fig. 16a).

Let us create hologram 2 of the object 1, using light with λ_1 (Fig. 16b). When such a hologram is illuminated by white light f in the reference wave λ_1 direction only wave λ_1 is able to reconstruct the object (Fig. 16c).



Fig. 17. Yu. Denisyuk reconstructed from a hologram and alive (VRC, 2006)

However, as mentioned above, such a reconstruction is a monochromatic one, only. What about colour holograms? To produce colour hologram, one needs three lasers generating on three basic wavelengths (red, green, blue) to record such a hologram. Each of the waves creates own interference structure (Fig. 18). After illuminating such a hologram with white light, each structure helps to reconstruct the object wave in related wavelength. The reconstruction is seen in three colours and thanks to sophisticated activity of our brain as colourful.

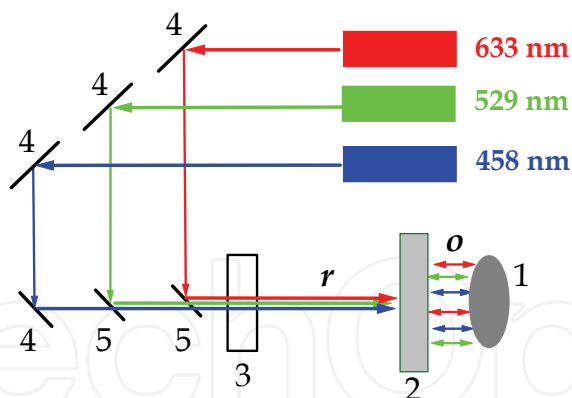

Fig. 18. A colourful hologram recording (1-object, 2-recording medium, 3-optics to spread light, 4-mirror, 5-semitransparent mirror)

- h. Well, not to forget, something interesting, else - to perform reconstruction one does not need to use the same wavelength (λ_2) as while recording (λ_1). When $\lambda_2 > \lambda_1$, the reconstructed 3D image will be magnified. Just that was the marvellous idea of Dennis Gabor: ... to record the hologram in the region of X-rays ($\sim 10^{-10}\text{m}$) and to reconstruct it in the visible ($\sim 10^{-7}\text{m}$) region, great magnification ($\sim \lambda_2/\lambda_1$) can be obtained without any limitation by objective properties.... (Gabor, 1971).

Both, transverse β_{\perp} and longitudinal β_{\parallel} magnification (Kreis, 2005, pp. 44-47) depends on recording and reconstructing set-ups ($R_1, L_1, \lambda_1, L_2, \lambda_2$)

$$\beta_{\perp}^{(r,v)} = \left[1 - \frac{R_1}{L_1} \pm \frac{\lambda_1 R_1}{\lambda_2 L_2} \right]^{-1} \quad \beta_L^{(r,v)} \approx \frac{\lambda_2}{\lambda_1} \left[\beta_{\perp}^{(r,v)} \right]^2 \quad (32)$$

where sign $-/+$ is related to real (r)/virtual (v) reconstruction.

3.4 Some applications

Great development and application of holography began after invention of laser producing coherent light, which is necessary to produce a hologram. Let us mention briefly some examples, at least. The explanation is simplified and only the basic ideas are pointed.

3.4.1 Holographic storage

Storage requirements are exploding today. Faster access, higher data rates and redundant storage of data within the volume of a thicker medium require a new approach. Optics and the basic principles of holography are a particularly attractive way to meet these requirements and may well represent the storage solution of the future. Holographic storage represents an opportunity to significantly increase data densities beyond those offered in conventional removable storage technologies, and to increase data transfer rates well beyond those that might be envisioned from today's storage products.

Data are encoded onto the object beam by spatial light modulator (SLM), which translates the electronic data of 0s and 1s into an optical "checkerboard" pattern (Fig. 19) of light and dark pixels. Unlike other technologies holographic one writes data through the full depth of the recording medium. By varying the reference beam angle or media position hundreds of unique holograms are recorded in the same volume of material. The effective area storage density (bits/unit area) can be significantly increased by using a thick recording layer to record multiple, independent pages of data. The holographic structure for one page is intermixed with the holographic structures of each of the other pages. This process has been known as *multiplexing*.

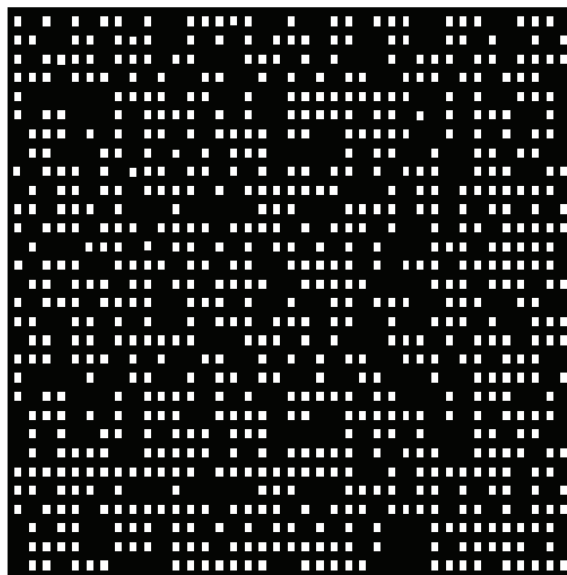

Fig. 19. 2D digital data

Retrieval of an individual page with minimum cross talk from the other pages is a consequence of the volume nature of the recording and its behaviour strongly depends on mismatches in angle or wavelength between recording and reconstruction. Moreover, information distribution throughout the recording volume allows reducing sensitivity to material defects.

It is most important to realise that over a million bits of data are written and later read with a single flash of light holographically. Namely, data pages in whole and not serial stream of bits, only, are either written or read simultaneously.

Since holography makes use of the full thickness of the recording material, providing data densities proportional to media thickness, capacities of more than 1,000 GB on a CD disk format, can be achieved.

Data stored holographically are transferred as pages of optical information. This parallel read out of data provides holography with its relatively fast transfer rates. Consequently, holography provides a substantially faster data transfer rate from a single head, surpassing 100 MB/sec.

Companies developing holographic data storage systems have made enormous technical advances towards their goal of inventing an optical data storage system (InPhase, 2007; STX Aprilis, 2006). A prototype that holds 200 gigabits per square inch of storage capacity was demonstrated in 2007.

3.4.2 Optical processor and holographic optical elements

Generally, optical processor is a device used to process optical information, i.e. to record, to retrieve and to recognize it. Fig. 20 demonstrates the principle of any optical processor – projection utilizing two lenses 2 and 4 with common focal plane 3. The lens 4 projects the object from the first focal plane of the lens 2 into its second focal plane. Why such a complicated projection? The common focal plane 3 becomes accessible to filtrate optical information processed. Namely, it is the plane where Fourier transform (Smith et al., 2007) of the object is created.

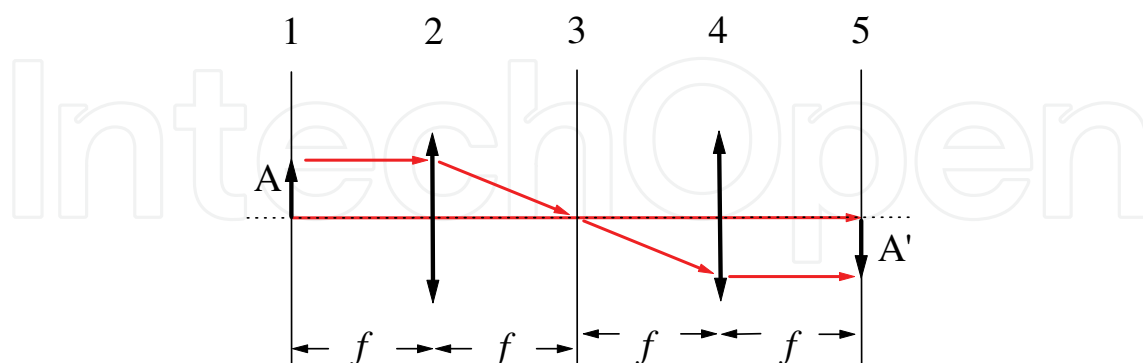

Fig. 20. Optical processor (2, 4 - lenses, 1 -object plane, 3-filtration plane, 5-image)

In principle, the experimental set-up of a real optical processor follows the set-up used to record and retrieve a Fourier hologram. It is only equipped with helping elements, enabling multiple recording and reading. However, the object has to be in form of 2D transparent covered by pattern of 1s and 0s and plane wave is used as a reference one.

Especially, information recognition process, when we are looking for a certain kind of information (e.g. A) in noise, takes a great attraction. A proper filter, Fourier hologram of A – $FH(A)$ has to be prepared (Fig. 21a). Now, the object wave Σo in which o_A is supposed to be included enters the optical processor.

When there is no filter in the common focus plane 3, image of the object related to the wave Σo is created in the output focal plane 5 of optical processor. If information A is included in Σo , a plain wave occurs in light of Fourier transform of Σo transmitting the filter $FH(A)$. After passing through the second lens it creates an intensive light point R in its second focal plane (Fig. 21b). The appearance and position of this bright point tells us about presence and position of information we are looking for in noise.

Naturally, Fig. 21 is simplified. In reality, one does not know the position of A and $FH(A)$ is made with A on the axis. It only results in a shift of the image in whole with the light point R in the output focal plane 5.

Where to use such a method? What about fingerprints recognition in a database of fingerprints used instead of noise with information included?

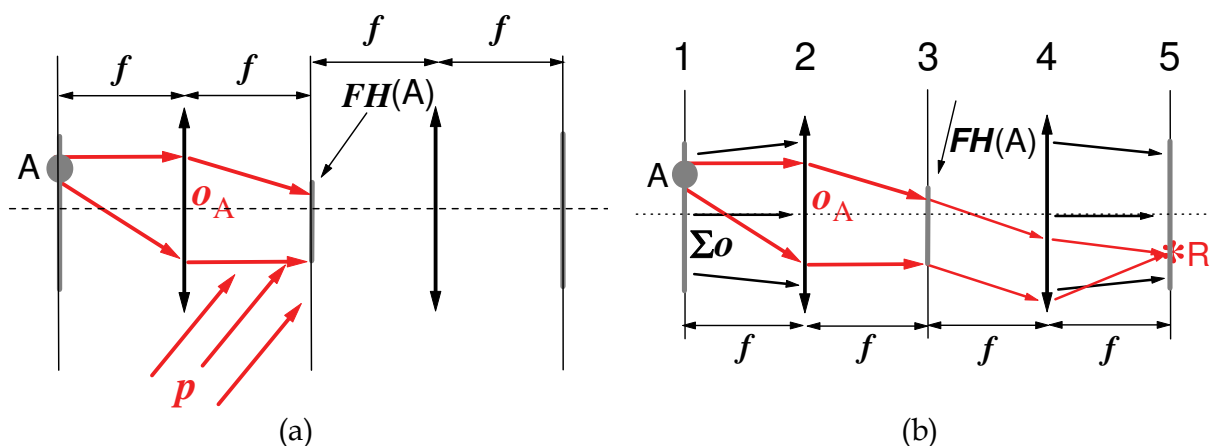

Fig. 21. Information recognition – making a holographic filter to recognize information A (a) and recognition A (b)

Holography also enables us to create various optical elements, like lenses, gratings, prisms, beam splitters, and so on, in a simply way. Despite working by diffraction and not by reflection or refraction, they can be used for any purpose that conventional optical elements can be used for.

Especially holographic gratings can demonstrate the advantage of such an approach. To make classically the dense line structure of a grating, a special ruling engine had to be used. Instead mechanically ruled grating grooves a hologram of a plane wave with plane reference wave can be recorded. The interference pattern has the form of regular parallel strips – intensity maxims and the grating interval can be changed very simply, by choosing a proper angle between the interfering waves (24). Besides spectroscopy, a grating can be used as either a beam splitter or a beam-directing element.

Similarly, a hologram of a converging or a diverging wave can be used as a lens.

3.4.3 Holographic interferometry

Interferometry is a method based on interference of light. It enables to determine the object variations in the scale of the wavelength λ of used light. Such a method had been known and used since man got familiar with the phenomenon of interference of light.

To observe interference coherent light is required. Because of that invention of lasers, sources of coherent light became a great advancement. Classical interferometry had been limited by the high optical quality requirements for both all the optical elements used in the set-up and studied surfaces (roughness $< \lambda/20$).

Holography brought something impossible to be performed before. Holography enabled to study rough surfaces, which scatter incident light. Moreover, it added a kind of bonus – to examine objects, even not existing already. A simply explanation can be found using Fig. 22, where basic experimental set-ups used for classic (a) and holographic (b) interferometry are shown.

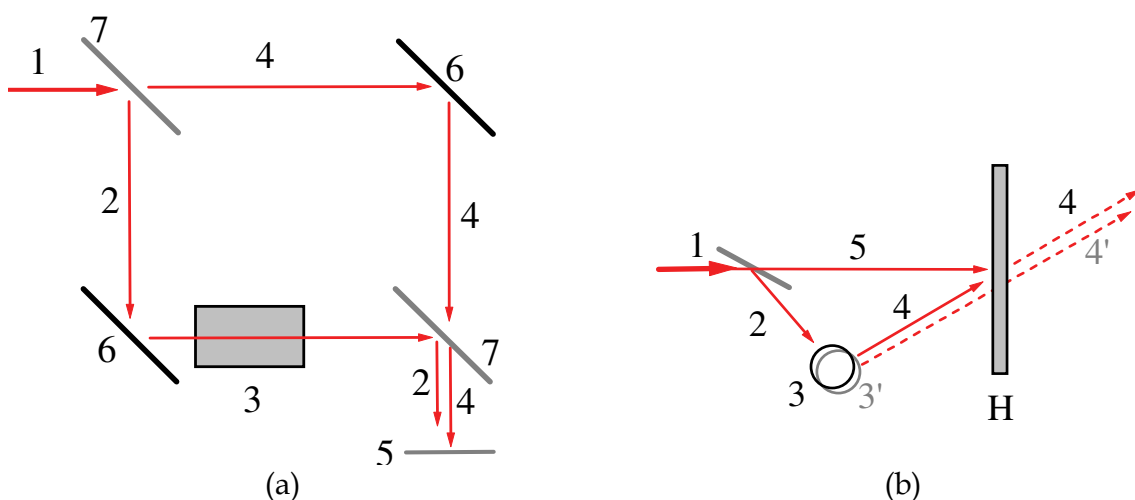

Fig. 22. Classical (a) and holographic (b) interferometry

In classical interferometry (a) the original light wave 1 (usually a plane one) is split into two parts. One of them (2) passes the examined object 3 (transparent one in our case). The second wave 4 spreads without any change. Both waves are directed by splitter 7 and mirrors 6 mostly to the same direction to cover each other. They are coherent and able to interfere. The interference pattern can be observed/detected/recorded in any plane like 5. The local resulting intensity of light depends on the phase difference between two waves met at that point. Any change of the object causes a relating change of the interference pattern shape and intensity, which allows us to estimate the changes of the object.

Naturally, all of that is true *only* when the changes of the wave 2, comparing to the wave 4, are caused *only* by the changing object. Just that is the reason of high optical quality of all the elements and object surfaces required. The wave changed by an object is compared to a kind of “an ideal” wave.

In holographic interferometry (b), at least one of the interfering waves has to be reconstructed from a hologram. An original wave 1 is split into two parts, again. One of them is scattered by the object 3 (an example of non transparent object is used now) and creates the object wave to record a hologram. The second part serves as a reference wave 5 to record the hologram of the object in a basic state. There are more ways how to proceed

now. For example, the hologram is recorded, processed and returned back, into the same set-up and place where recorded – so-called *real-time interferometry*. Now, reference beam 5 reconstructs the object wave in the basic state. The changing object provide us with the next object wave 4', which interfere with the reconstructed wave 4. Interferogram varies in real time, simultaneously with the varying object.

As you may have noticed, now, the changing object wave does not interfere with a kind of “an ideal” wave. The interference pattern results now from the interference of two object waves, which differ due to various states of the object. They represent two different states of the object. The interference observed is not handicapped by any possible low optical quality of the set-up elements.

The reason is that the low quality is *the same* in both states of the object. Two interfering waves 4 and 4' differ *only* because of changing object.

Another possibility would be for example – to record both the states of the object without any other change in the set-up, to process the hologram and reconstruct two object waves simultaneously. It is said to be *double exposure holographic interferometry*. When taking into account the pros and cons, it is very useful especially in the case of fast running processes.

Because of the interference of two object waves holographic methods in interferometry enable to study objects scattering the incident light. Such objects are impossible to be studied in the frame of so-called classical interferometry.

And why could we examine objects and study interferograms even without having a real object? Of course, we have to have it when recording holograms. We can have holograms of various states of the object and reconstruct them two various at once. Two reconstructed waves of two various states of the object interfere and create the interference pattern one can study.

Concluding, I would like to illustrate an example of holographic interferometry used to find optical thickness radial profile of an optical fibre (Fig. 23).

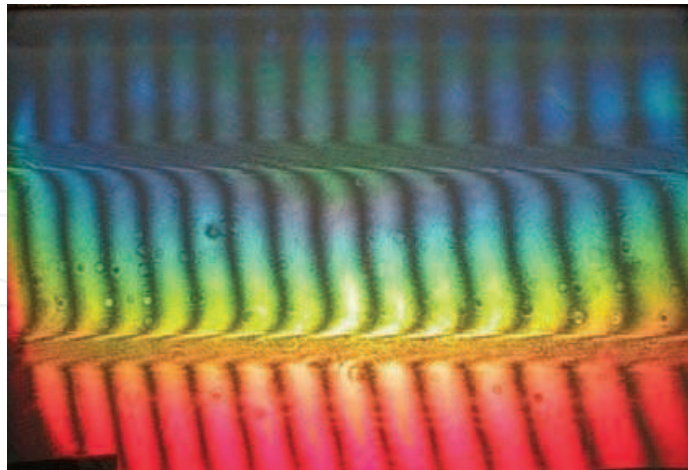

Fig. 23. Interferogram - holographic interferometry of an optical fibre

A plane wave crossing the fibre served as the object beam. The fibre was projected at the hologram with a proper magnification, double exposed hologram was recorded and the phase shifting interferometry was applied, i.e. the angle of incident of the reference beam was a little bit shifted before exposition of the second state of the object. As two “object

states were used a cell filled with glycerine and the fibre embedded into it and the same cell filled with glycerine without the fibre. This way the producer's data, relating to the preform were approved. The paper "Senderakova et al. (2004), Interferometric analysis of optical fibre profile" was published in Slovak, only, so it is not included into references.

4. Conclusion

I would like to notice that information above has not been any complete and exhaustive overview of the field of holography. Internet can show itself as a rich source of simple explanations as for holography and its applications. Material collected and submitted here, should only help to understand the basic physical principles used in holography. It may open a gate to understanding various interesting and many times astonishing applications of holography one can meet today.

When understanding the principle, a hologram can be generated using a computer, too. *Computer-generated holograms* find applications especially in the role of holographic optical elements. Method of electron beam lithography enables to write structures on the order of $0.1 \mu\text{m}$. Such holograms are reconstructed optically.

Digital holography is another contemporary term. In this case, hologram is recorded and stored electronically. Unquestionably, it is much simpler way comparing to using a photo-material. However, there is a restriction – size of pixels, which has to be taken into account, when regarding spatial frequency of holographic interference pattern (Kreis, 2005). When using wavelength λ , the spatial frequency $1/d$ (24) is defined by the angle between object and reference waves. Moreover, when considering so-called *sampling theorem* (Kreis, 2005), i.e. the period d must be sampled with more than two pixels, the allowed angle between object and reference waves must not exceed approximately $(2-3)^\circ$. Reconstruction, i.e. the diffraction pattern is calculated numerically (Schnars & Jueptner, 2005) in a computer. Digital holography finds its applications in interferometry. However, non-interferometric applications can be met, too – e.g. particle analysis, microscopy, and data encryption (Kreis, 2005).

Holography is not restricted to optical coherent waves, only. It also might be interesting to notice holography based on either acoustic or ultrasound waves – *acoustic holography* and *ultrasound holography*.

Electron holography is the application of holography techniques to electron waves. Let us realize that it was just electron holography, which was invented by Dennis Gabor, having been worked on improving the transmission electron microscope. The principle of such a holography can also be applied to interference lithography.

SPIE's 2011 International Symposium on Optics & Optoelectronics (Prague 2011) focused besides other technologies, also on holography. Sessions of one of the technical conferences during the symposium – *Holography: Advances in Holography and Modern Trends* (8074) shows contemporary topics in holography: digital and computer generated holography, security holography and holographic diffractive optics, recording materials and information storage, and holographic methods and other applications. For example, let us mention

- digital holographic microscopy, a non-invasive technique for imaging transparent samples
- computer generated holographic optical elements to compensate aberrations

- special photographic emulsion, organic glasses, photopolymers, photorefractive materials as recording materials
- polarization holography for optical trapping and manipulation, hologram multiplexing methods, holographic lithography for making large photonic crystals easily, application of the laser analyzer for identification in real time of security holograms for various documents, security holograms, optical holography and its applications in solar energy concentrations, and so on.

When asking about the future of holography, allow me to quote Emmett Leith, one of holography fathers (Ludman et al., 2002): *“Holography in the 21st century will continue to flourish. Its growth will result in large part from the advancement of the technologies on which holography depends: the computer, the electronic camera, the advances in real-time recording and display media, the advances in development of mask making and others. At the same time, as holography grows and as new forms develop, the boundary between holography and non-holography will become more indistinct.”*

5. Acknowledgment

I would like to express this way my sincere thanks to Faculty of Mathematics and Physics, Comenius University at Bratislava, which provided me with a possibility to get familiar with beauty of new, contemporary optics. I, also, would like to express my thanks to all of my close colleagues and students, for transforming the atmosphere of my working place into a home atmosphere, indeed.

6. References

- Benton, S.A. (1969). Hologram Reconstruction with Extended Incoherent Sources, *J. Opt. Soc. Am.*, Ser. A, vol. 59, pp. 1545-1546
- Davidson, M. W. & The Florida State University. (1995). Timeline in Optics, In: *Molecular Expressions – Optics*, (March 2011), Available from: micro.magnet.fsu.edu/optics/timeline/index.html
- Denisyuk, Yu. N. (1962). On the reflection of optical properties of an object in the wave field of light scattered by it, *Doklady Akademii Nauk SSSR*, vol.15, No 5, p.1275
- Gabor, D. (1971). Holography 1948-1971, In: *The Nobel Prize in Physics 1971*, March 2011, Available from: nobelprize.org/nobel_prizes/physics/laureates/1971/gabor-lecture.pdf
- InPhase. (2007). Overview, In: *InPhase Technologies: Products*, March 2011, Available from: www.inphase-tech.com/products/default15b9.html?tnn=3
- Kreis, T. (2005). *Handbook of Holographic Interferometry (Optical and Digital Methods)*, WILEY-VCH Verlag GmbH & Co. KGaA, ISBN 3-527-40546-1, Weinheim
- Levis, G. N. (1926). The Conservation of Photons, *Nature*, vol. 118, Part 2, pp. 874-875), Available from: www.nobeliefs.com/photon.htm
- Ludman, J., Caulfield, H. J., & Riccobono, J. (Eds.). (2002). *Holography for the New Millenium*, Springer-Verlag New York, Inc., ISBN 0-387-95334-5, New York
- Schnars, U., & Jueptner, W. (2005). *Digital Hologram Recording, Numerical Reconstruction, and Related Techniques*, Springer-Verlag Berlin Heidelberg, ISBN: 978-3-540-21934-7

- Smith, F. G., King, T. A. & Wilkins, D. (2007). *Optics and Photonics* (2nd edition), John Wiley & Sons, Ltd, ISBN: 978047001838 (HB), Great Britain
- Stevenson, D., C. (1994). Aristophanes - The Clouds, In: *The Internet Classics Archive*, (March 2011), Available from: <classics.mit.edu/Aristophanes/clouds.html>
- STX Aprilis. (2006). Holographic Data Storage, In: *Media Products*, (March 2011), Available from: <<http://stxaprilis.com/datastorage.htm>>
- VanRenesse Consulting. (2006). Yuri Denisyuk - Pioneer of modern holography, In: *VanRenesse Consulting - Photography*, March 2011, Available from: <www.vanrenesse-consulting.com/index.php?page=photography.htm>

IntechOpen

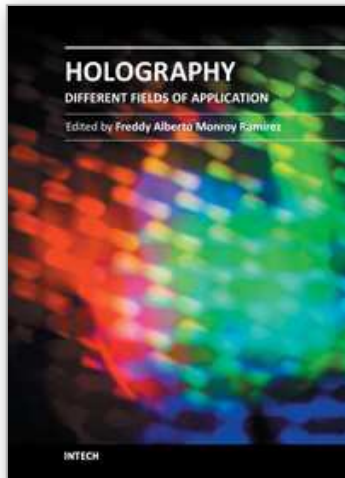

Holography - Different Fields of Application

Edited by Dr. Freddy Monroy

ISBN 978-953-307-635-5

Hard cover, 148 pages

Publisher InTech

Published online 12, September, 2011

Published in print edition September, 2011

This book depicts some differences from the typical scientific and technological literature on the theoretical study of holography and its applications. It offers topics that are not very commercial nor known, which will allow a different view of the field of optics. This is evident in chapters such as “Electron Holography of Magnetic Materials”, “Polarization Holographic Gratings in Polymer Dispersed Formed Liquid Crystals, and “Digital Holography: Computer-generated Holograms and Diffractive Optics in Scalar Diffraction Domain”. The readers will gain a different view of the application areas of holography and the wide range of possible directions that can guide research in the fields of optics.

How to reference

In order to correctly reference this scholarly work, feel free to copy and paste the following:

Dagmar Senderakova (2011). Holography – What is It About?, Holography - Different Fields of Application, Dr. Freddy Monroy (Ed.), ISBN: 978-953-307-635-5, InTech, Available from:

<http://www.intechopen.com/books/holography-different-fields-of-application/holography-what-is-it-about->

INTECH
open science | open minds

InTech Europe

University Campus STeP Ri
Slavka Krautzeka 83/A
51000 Rijeka, Croatia
Phone: +385 (51) 770 447
Fax: +385 (51) 686 166
www.intechopen.com

InTech China

Unit 405, Office Block, Hotel Equatorial Shanghai
No.65, Yan An Road (West), Shanghai, 200040, China
中国上海市延安西路65号上海国际贵都大饭店办公楼405单元
Phone: +86-21-62489820
Fax: +86-21-62489821

© 2011 The Author(s). Licensee IntechOpen. This chapter is distributed under the terms of the [Creative Commons Attribution-NonCommercial-ShareAlike-3.0 License](https://creativecommons.org/licenses/by-nc-sa/3.0/), which permits use, distribution and reproduction for non-commercial purposes, provided the original is properly cited and derivative works building on this content are distributed under the same license.

IntechOpen

IntechOpen