

We are IntechOpen, the world's leading publisher of Open Access books Built by scientists, for scientists

5,600

Open access books available

138,000

International authors and editors

170M

Downloads

Our authors are among the

154

Countries delivered to

TOP 1%

most cited scientists

12.2%

Contributors from top 500 universities



WEB OF SCIENCE™

Selection of our books indexed in the Book Citation Index
in Web of Science™ Core Collection (BKCI)

Interested in publishing with us?
Contact book.department@intechopen.com

Numbers displayed above are based on latest data collected.
For more information visit www.intechopen.com



Propagation Path Loss Modelling in Container Terminal Environment

Slawomir J. Ambroziak, Ryszard J. Katulski,
Jaroslaw Sadowski and Jacek Stefanski
*Gdansk University of Technology
Poland*

1. Introduction

Container port area should be treated as a very difficult radio waves propagation environment, because lots of containers made of steel are causing very strong multipath effect and there is time-varying container arrangement in stacks of different height. Path loss modelling for such area is still complex task and has not yet been considered in scientific research. But as the total amount of cargo carried yearly in containers by land and sea increases, the only effective way of controlling such huge number of containers is to build efficient electronic container supervision systems. Nowadays almost all the major container ports have some kind of radio monitoring of containers, based on available radio communication standards (GSM/GPRS, UMTS, TETRA, WiFi, WiMAX, ZigBee, Bluetooth, many different RFID systems or other solutions in unlicensed frequency band) working in frequency range from about 0.4GHz to 5GHz. It should be noted that ITU-R did not present any special recommendation for propagation path loss prediction for radio link in container terminal environment. Differences in spatial arrangement and structure between container stacks and typical urban or industry area can cause relevant path loss prediction errors in case of use inadequate path loss model, so the special survey of propagation phenomenon in container terminal area becomes crucial.

At the outset of the chapter, radio links are characterized in terms of transmission loss and its components. Then authors discuss the requirements concerning measuring equipment, its calibration process, measurement methodology, as well as the processing and presentation of their results (Ambroziak, 2010).

The main part of the chapter presents new analytical approach to path loss modelling in case of propagation in container port environment, based on empirical results from measurement campaign in Gdynia Container Terminal (Poland). Upon the results of almost 5 thousands propagation path measurements in real container terminal environment, a novel analytical model was developed. Additionally, authors present mobile measuring equipment used to research in DCT Gdansk Container Terminal (Poland) and planned results of the analysis of nearly 290 thousand of propagation cases which were collected. It is an introduction to generalization of the propagation model for container terminal environments (Katulski et al., 2009).

2. Normative requirements

The propagation medium is a factor that causes many difficulties in designing wireless networks, because of large diversity of propagation environments, which includes rural, urban, industrialized, marine and mountainous environments. The radio wave attenuation in each environment is determined by many variables phenomena and factors. It is essential to determine the radio wave attenuation (so-called transmission loss) to a specified accuracy. Knowledge of transmission loss is necessary to meet energy requirements in radio links designing (Katulski, 2009).

Therefore, there is a need to create empirical propagation models for different environments, based on measuring research results. So far a number of such models has been developed, mainly for urban and indoor environments. However, the environments in these groups may also differ within. Because of this, the issue of radio wave propagation measuring research is still a current topic, especially for designing the radio networks in specific environments.

At present, the Department of Radiocommunication Systems and Networks in the Gdansk University of Technology is carrying out the wide research on radio wave propagation. Very important are normative requirements - as described in literature, such as ITU-R Recommendations - that have to be met during research on radio wave propagation.

In this subsection a radio link is characterized in scope of transmission loss and its components. Then the next to be discussed are requirements concerning measuring equipment, its calibration process, measurement methodology, as well as the processing and presentation of results.

2.1 Description of the measuring radio link

As known, power of signal transmitted in the radio link is significantly attenuated. The effect of this is the large difference between signal power at the output of transmitter and power of the same signal available at the input of receiver. This difference depends on many factors, mainly transmission loss of propagation medium, as well as the power losses in the transmission feeder lines, the losses due to measuring devices, the antenna losses due to the impedances or polarization mismatch, etc.

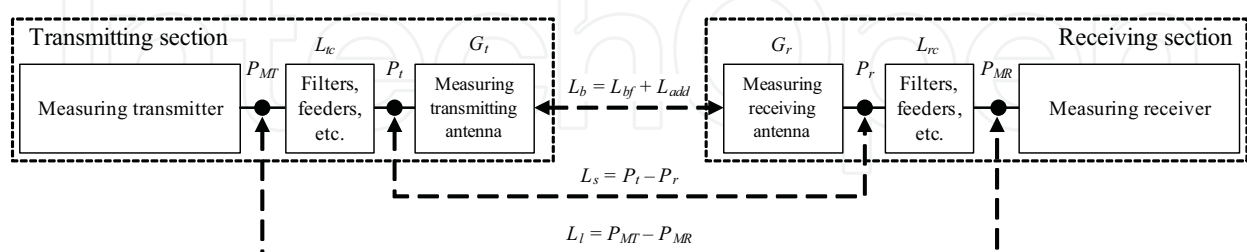

Fig. 1. Graphical presentation of terms used in the measuring transmission loss concept

Therefore, there is a necessity to systematize terminology and symbols used in analyzing the transmission loss and its components. It may be presented using a graphical depiction of terms used in the measuring transmission loss concept, shown in Fig. 1 (Ambroziak, 2010), which considered all essential factors affecting the energy level in radio link, such as:

- total loss of a measuring radio link between transmitter output and receiver input,

- system loss between input of the transmitting antenna and output of the receiving antenna,
- basic transmission loss of the radio link,
- free-space basic transmission loss, that is a basic component of transmission loss.

The total loss of a measuring radio link (symbol: L_l [dB]) is defined as the difference between power P_{MT} [dBW] supplied by the measuring transmitter and power P_{MR} [dBW] available at the input of the measuring receiver in real installation, propagation and operational conditions (ITU-R P.341-5, 1999). The total loss may be expressed by:

$$L_l[\text{dB}] = P_{MT}[\text{dBW}] - P_{MR}[\text{dBW}] = 10 \log \left(\frac{p_{MT}[\text{W}]}{p_{MR}[\text{W}]} \right), \quad (1)$$

where lowercase letters, i.e. p_{MT} and p_{MR} , are power at the output of measuring transmitter and power at the input of measuring receiver, respectively. They can be expressed in absolute values, such as [W], or in relative values, such as [dBW], in that case they are written as uppercase letters, P_{MT} and P_{MR} , respectively. Total loss includes all factors affecting the power of received signal, i.e. basic transmission loss of propagation medium, gains of antennas, loss in feeder lines, etc. Knowledge of the total loss components is necessary to correctly determine the value of the basic transmission loss.

The system loss (symbol: L_s [dB]) is defined as the difference between power P_t [dBW] supplied at the terminals of measuring transmitting antenna and power P_r [dBW] available at the terminals of measuring receiving antenna (ITU-R P.341-5, 1999). By analogy with equation (1), it may be written as follows:

$$L_s[\text{dB}] = P_t[\text{dBW}] - P_r[\text{dBW}] = 10 \log \left(\frac{p_t[\text{W}]}{p_r[\text{W}]} \right). \quad (2)$$

In addition to basic transmission loss, the system loss also includes influence of circuits associated with the measuring antennas, such as ground losses, dielectric losses, antenna loading coil losses and terminating resistor losses. But on the other hand, the system loss excludes losses in feeder lines, both in the transmitting section (L_{tc} [dB]) and in the receiving section (L_{rc} [dB]). Considering Fig. 1, it can be written as follow:

$$L_l[\text{dB}] = L_s[\text{dB}] - L_{tc}[\text{dB}] - L_{rc}[\text{dB}]. \quad (3)$$

The basic transmission loss (symbol: L_b [dB]) consists of free-space basic transmission loss L_{bf} [dB] and additional loss L_{add} [dB], resulting from the real conditions of propagation environment, different from ideal free space. From this point of view, the basic transmission loss may be expressed by:

$$L_b[\text{dB}] = L_{bf}[\text{dB}] + L_{add}[\text{dB}]. \quad (4)$$

The additional loss L_{add} includes phenomena occurring in real propagation environments. In terms of measurement procedures, the most important are:

- loss dependent on path clearance,
- diffraction fading,
- attenuation due to rain, other precipitation and fog,

- fading due to multipath.

Equation (4) is a case of isotropic radiation, i.e. it excludes characteristics of real antennas, especially its directional characteristics and power efficiency, which are described by power gain. Taking into consideration the link power budget, in case of free-space environment, the basic transmission loss may be expressed by:

$$L_b[dB] = P_t[dBW] - P_r[dBW] + G_t[dBi] + G_r[dBi], \quad (5)$$

where G_t and G_r (in [dBi]) are the isotropic (absolute) gains of the transmitting and receiving antennas, respectively, in the direction of propagation. Table 1 gives the power gains for typical reference antennas (ITU-R P.341-5, 1999).

Reference antenna	g	G = 10 log g [dBi]
Isotropic in free space	1	0
Hertzian dipole in free space	1.5	1.75
Half-wave dipole in free space	1.65	2.15
Hertzian dipole, or a short vertical monopole on a perfectly conducting ground	3	4.8
Quarter wave monopole on a perfectly conducting ground	3.3	5.2

Table 1. The power gains for typical reference antennas

As known, free space is an ideal case of propagation environment, open and without any propagation obstacles. It is a perfectly dielectric, homogenous and unlimited environment, characterized by a lack of influence of Earth surface on radio wave propagation and non-absorbing the energy of the electromagnetic field (Katulski, 2009).

Assuming free-space propagation environment and distance (d [m]) between antennas of the measuring radio link much larger than wavelength (λ [m]) of test signal, the free-space basic transmission loss (symbol: L_{bf} [dB]) may be expressed by a well-known equation (ITU-R PN.525-2, 1994):

$$L_{bf}[dB] = 20 \log \left(\frac{4\pi \cdot d[m]}{\lambda[m]} \right). \quad (6)$$

2.2 Standardization of measuring apparatus

In order to ensure accurate measurement results in frequency range 9 kHz to 3 GHz and above (up to 40 GHz), the ITU-R recommends (in SM.378-7) the method of installation and calibration of measuring systems. The document also determines the accuracy, that are required in field-strength measurements, assuming no noise of receiver, atmospheric noise or external interference. Taking these assumptions into account, the expected accuracy of measurements should be:

- for frequency band 9kHz to 30MHz: ± 2 dB,
- for frequency band 30MHz to 3GHz: ± 3 dB.

If recommended values are not obtainable (for various reasons, such as limitation of the measuring receiver, interference, instability of the test signal, etc.), nevertheless the accuracy specified above should be taken into consideration (ITU-R SM.378-7, 2007).

Depending on the electrical parameters, which the receiving antenna and the measuring receiver were calibrated for, the measuring receiver may measure the following quantities:

- signal power at the receiver input, resulting from the power flux density of electromagnetic wave at the point of reception (the point of the receiving antenna placement),
- voltage at the receiver input, resulting from the electric field intensity at the point of reception,
- current at the receiver input, resulting from the magnetic field intensity at the point of reception.

And so, for the receiving antenna which was calibrated for power flux density of electromagnetic wave, at the receiver input the power P_{MR} is available and measured (Fig. 1). This power is the basis for determining of basic transmission loss L_b , according to equation (8). Similar equations may be written for the case of the receiving antennas, calibrated for electric or magnetic component of electromagnetic field.

Type of receiving antenna may affect the type of measuring receiver – the electrical signal, measured by the measuring receiver should correspond with electrical signal (which the antenna was calibrated for) available at output terminals of the receiving antenna. For example, for short monopole antenna of a specified length, the receiver should measure voltage of test signal, and for the inverted cone type vertical antenna the receiver should measure power of test signal.

Recommendation SM.378-7 contains examples of antennas for different frequency ranges. For frequencies below 30MHz it is recommended to use vertical or loop antennas. In case of the vertical antenna, the monopole antenna shorter than one-quarter of a wavelength may be used with a RF ground system, built of radial conductors at least twice the length of the antenna and spaced 30° or less. Instead of radial conductors, an equivalent RF ground screen may be used. There is also a possibility to use an inverted cone type vertical antenna with similar construction of RF ground system. It allows to obtain a greater power gain of measuring antenna than the quarter wave monopole antenna.

For frequency range 30MHz to 1GHz it is recommended to use a short monopole antennas, half-wave dipoles or high-gain directional antennas, but it is essential to ensure the same polarization of receiving antenna as the transmitting antenna. For field-strength measurements at frequencies above 1GHz it is recommended to use directional antennas with matched polarization.

It should be noted that the height of antenna installation has a significant influence on the measurement results, especially when the height is electrically small (Barclay, 2003). And so, if antennas are installed in close proximity to the ground, the electromagnetic waves take the form of surface waves, which takes effect to the wave depolarization, consequently there is wave attenuation resulting to the polarization mismatch in the radio links. In addition, the radio wave attenuation increases due to losses related to the penetration of radio waves into the propagation ground (Katulski, 2009). To minimize influence of the Earth surface on test signal, transmitting antenna has to be installed at a height that enables space waves propagation (Barclay, 2003). Therefore, the ITU-R recommends that for frequency range 30MHz to 1GHz, the installation of the transmitting antenna should be at least 10 meters high (ITU-R SM.378-7, 2007). The recommended height of the receiving antenna is 1.5 up to 3 meters (ITU-R SM.1708, 2005).

The measuring receiver primarily should have stable parameters (inter alia: gain, frequency, bandwidth), that have an influence on the accuracy of test signal measurement (its voltage, current or power). Local oscillators should have low phase noise, the operating dynamic range should be greater than 60dB and the bandwidth should be wide enough to allow reception of essential parts of the test signal spectrum. Type of detector depends on the bandwidth and the modulation mode of test signal. The required bandwidth and detector functions for various signal types are compiled in Table 2 (ITU-R SM.1708, 2005).

Example of signal types	Minimal bandwidth (kHz)	Detector function
AM DSB	9 or 10	Linear average
AM SSB	2.4	Peak
FM broadcast signal	170 or greater	Linear average (or log)
TV carrier	200 or greater	Peak
GSM signal	300	r.m.s.
DAB signal	1 500	
DVB-T signal Systems: 6 MHz	6 000	
7 MHz	7 000	
8 MHz	8 000	
TETRA signal	30	Linear average (or log)
UMTS signal	3 840	
Narrow-band FM radio Channel spacing: 12.5kHz	7.5	
20kHz	12	
25kHz	12	

Table 2. The required bandwidth and detector functions for various signal types

Properly configured spectrum analyzer may be used as the measuring receiver, whose work may also be automated. The measuring receiver, with remainder of the receiving section, may be mounted on a vehicle or a hand-cart, that enables mobile measurements in the area of propagation research.

Each of measuring devices and circuits (feeder lines, filters, etc.), that affect total loss of a measuring radio link, are usually calibrated in accordance with certain standards as one of the stages of their production. Nevertheless it is recommended to calibrate transmitting and receiving section as a single entities (ITU-R SM.378-7, 2007). The above allows to take into account the influence of all elements of the measuring radio link, including attenuation due to the ground, masts, etc.

The calibration procedures, presented below, deal with the case of basic transmission loss calculation based on power measurement. Calibration of the transmitting section concerns

set-up of power P_{MT} value, in order to obtain required value of P_t at the input terminals of transmitting antenna. Calibration process of the receiving section deals with calculation of the difference (in logarithmic scale) between power of test signal available at the output terminals of receiving antenna and the power of test signal at the input of the measuring receiver. After taking into account the power gain of receiving antenna, it is possible to calculate a correction factor (F_c [dB]) as follows (see Fig. 1):

$$F_c[dB] = L_{rc}[dB] - G_r[dBi] = P_r[dBW] - P_{MR}[dBW] - G_r[dBi]. \quad (7)$$

Considering equation (5) and Fig. 1, which implies that $P_r = P_{MR} + L_{rc}$ after simple transformation, the basic transmission loss may be calculated using following equation:

$$L_b[dB] = P_t[dBW] + G_t[dBi] - P_{MR}[dBW] - F_c[dB]. \quad (8)$$

The equation (8) is very important in measuring research and calculation of the basic transmission loss on the basis of power P_{MR} measurements at input of the measuring receiver. To calculate basic transmission loss it is necessary to know the following values:

- the power gain G_t of the transmitting antenna,
- the power P_t on input of the transmitting antenna – set during calibration process of the transmitting section,
- the correction factor F_c – calculated during calibration process of the receiving section.

Measuring apparatus should be recalibrated at least once a year or every time after change any of its parts (ITU-R SM.378-7, 2007).

2.3 Standardization of measuring procedures

There may be many various reasons for measuring research on radio wave propagation, inter alia: to create empirical propagation models or to estimate coverage of radio networks. This information may be useful in increasing efficiency of radio resources management or for controlling proper use of this resources by particular entities, and so on. Considering the above-cited, ITU-R recommends to unify methodology of measuring procedures and presentation of its results.

The measurement results should include information about slow and fast changes of the power flux density of electromagnetic field (slow and fast fading, respectively). So it is recommended to choose the measurement points in an appropriate manner. Measurements points should be spaced every 0.8λ along a route of radio waves propagation. It is recommended that the results should be averaged every 40λ (Lee, 1993).

Measurements may also be done automatically when the measuring receiver is mobile, but speed V [km/h] of the receiver is not arbitrary. It depends on the frequency f [MHz] of test signal and minimum time t_r [s] given by the receiver specifications to revisit a single frequency. It may be expressed by following equation (ITU-R SM.1708, 2005):

$$V[km/h] \leq \frac{864}{f[MHz] \cdot t_r[s]}. \quad (9)$$

In order to find relations between the basic transmission loss and the distance from the transmitting antenna, the result of each measurement should be correlated to the place of its execution. For this reason, the positioning system should be used for reading current

position of measuring receiver. It is recommended to use one of three systems specified in the ITU-R Recommendation SM.1708.

The GPS is a preferred positioning system, although its accuracy is limited in tunnels, narrow streets or valleys. Accuracy in position determining should be a few meters, which in most cases can be provided by GPS.

If unable to determine the position using GPS system, it is recommended to use dead reckoning system. Position is determined basing on information about starting point, direction of movement and distance covered by the receiver. It is also possible to use the complex navigation system, which is the combination of the above-mentioned systems.

Due to the large instability of propagation environment, the result of single measurement is not reliable or repeatable. Therefore, the measurement results should be classified in terms of probability of exceeding a particular value by the power of received signal. This probability may be in range of 1-99%, but typical values for this parameter are as follows: 1%, 10%, 50%, 90% and 99%. During research on radio wave propagation, the median value is recommended (ITU-R SM.1708, 2005), i.e. the value from an ordered subset of measurement results, which is exceeded by 50% of the other values from this subset.

In practice, for each i -th subset of measurement data, it is necessary to calculate the median of test signal power P_{MR}^i at the receiver input. Each subset of data is created on the basis of n measurement results, collected along the route at 40λ spacing in accordance with the following equation:

$$P_{MR}^i = \begin{cases} P_{MR, \frac{n+1}{2}}^i & , \text{if } n \text{ is odd,} \\ \frac{1}{2} \left(P_{MR, \frac{n}{2}}^i + P_{MR, \frac{n}{2}+1}^i \right) & , \text{if } n \text{ is even,} \end{cases} \quad (10)$$

where $P_{MR,1}^i \leq P_{MR,2}^i \leq P_{MR,3}^i \leq \dots \leq P_{MR,n-1}^i \leq P_{MR,n}^i$ is the subset of measurement results in non-descending order, and n is the number of measurement results taken on the i -th ($i = 1, 2, 3 \dots$) section of the radio waves propagation route.

Calculation of median values of the test signal power may be done in real time during the measuring research, but only calculated median values are recorded. It is also possible to record all the results and calculate median values after measuring research. Results obtained using both methods may be used to basic transmission loss modeling or estimating coverage of radio networks in the area under research.

There are three, recommended by ITU-R (SM.1708), methods of the measurement results presentation. The first one and the easiest is a table containing results of all measurements before calculating the median values. The advantage of this method is an access to information about local fading of test signal. However, there is a large number of data to analyze. In addition, it is hard to interpret a single result.

The second possibility is graphical representation of the pre-processed median values – as a function of distance – in the Cartesian coordinates. This way of data presentation helps to illustrate changes of the basic transmission loss in dependence on the distance from transmitting antenna.

The third one is a digital map of the area under research with marked colored points, that are representing a range of measured values of test signal power at input of the measuring receiver, assuming a known value of the equivalent isotropic radiated power (EIRP), which

is equal to the signal power P_t [dBW] supplied to the terminals of transmitting antenna plus power gain G_t [dBi] of this antenna. Map scale is dependent on the area where research is carried out. The advantage of this results presentation method is a simultaneous view on the value of received signal power and localization of each measurement. It is also possible to interpolate the results of measurements in order to estimate the radio coverage in the area. It should be noted, that on the basis of power measurements at the receiver input and using equation (8) it is easy to calculate the basic transmission loss in given propagation environment.

3. A novel empirical path loss model for container terminal

This subsection presents new analytical approach to path loss modeling in case of propagation in container port environment, based on empirical results from measurement campaign in Gdynia Container Terminal (Poland). Precise classification of propagation environment and selection of parameters which influence the propagation mechanism in essential way, allowed to define adequate multivariate error function for multidimensional regression analysis. As a result of this research, new analytical relation between propagation path parameters and path loss in container terminal scenario is proposed.

3.1 Measuring equipment

Block diagram of primary equipment set used in propagation measurements in container terminal scenario is presented in Fig. 2 (Katulski et al., 2008).

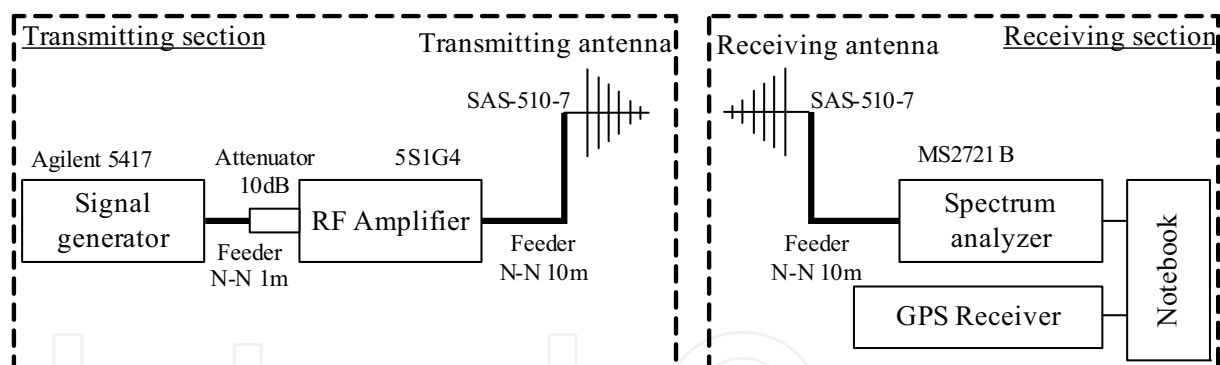

Fig. 2. Block diagram of primary measuring equipment set

Propagation path loss measuring equipment concept was based on fixed reference signal transmitter and mobile receiver equipment placed in many different positions in the area of container terminal. Harmonic signal without modulation, with frequency in range 0.5GHz to 4GHz, was emitted by transmitting antenna situated in various places in port. Power RF amplifier input was protected by precise 10dB attenuator. The receiving section was made of handheld signal spectrum analyzer working as a sensitive received signal power meter, GPS receiver and notebook with special software. All the receiver section components were battery powered. Log-periodic directional wideband antennas of the same type were used in both transmitter and receiver side. These antennas were calibrated by producer and have precise parameters in whole frequency range of interest.

Firstly the measurement plan assumed four reference signal frequencies: 1, 2, 3 and 4GHz, but during the measurement campaign additional frequency of 0.5GHz was also put into

investigation. Because the power amplifier used in transmitting section works properly only in frequency range 800MHz to 4.2GHz, schematic diagram of transmitting section in case of measurement at frequency 500MHz was slightly modified: additional attenuator and power amplifier had to be removed and the output of signal generator (with power level set to maximum value equal +9.6dBm) was directly connected to transmitting antenna via 10m long feeder.

3.2 Calibration procedure

In order to precisely compute the propagation path loss from power level of signal detected by handheld spectrum analyzer, radio link power budget equation have to include parameters of all the components from Fig. 2.

Because in the container terminal scenario, path loss of over 100dB should be expected, relatively high power test signal should be connected to the transmitting antenna. For the frequencies of 1GHz and above, constant power level +30dBm at the input of transmitting antenna was chosen. As the antenna's power gain at all the frequencies of interest is known (measured by manufacturer) and transmitter power level is being kept constant, equivalent isotropic radiated power (EIRP) can be simply computed for every frequency.

To ensure that accuracy of measurements doesn't vary with frequency, the transmitting and receiving section was calibrated in the Gdansk University of Technology laboratory. Firstly, the attenuation of transmitting section feeders at all the frequencies of interest was measured using vector network analyzer. The results are compared in Table 3.

Frequency [GHz]	1	2	3	4
Feeder loss between generator and additional attenuator [dB]	0.25	0.59	1.25	0.70
Feeder loss between amplifier and antenna [dB]	3.27	4.89	6.15	7.10

Table 3. Attenuation of transmitter section feeders

Although the power amplifier has smooth gain adjustment, authors decided to set the amplification to fixed value of 38dB (amplifier setting, real amplification value was not measured) and determine the signal generator output power that is necessary to achieve signal power at the input of transmitting antenna equal +30dBm. In laboratory conditions, spectrum analyzer from receiver section together with precise attenuator 20dB was used instead of antenna as a power meter (Fig. 3).

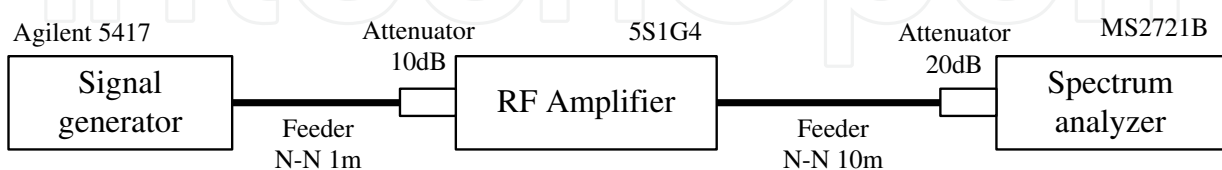

Fig. 3. Transmitting section calibration set schematic diagram

Evaluated generator output power values, which provided signal level of +10dBm at the input of spectrum analyzer (+30dBm at the input of transmitting antenna), are presented in Table 4. As the receiver antenna gain in whole band of interest was precisely measured by producer, the only part of receiver section from primary block diagram (Fig. 2) with unknown parameters is the feeder between antenna and handheld spectrum analyzer.

Frequency [GHz]	1	2	3	4
Signal generator output power [dBm]	4.5	7.4	7.2	7.8

Table 4. Output power level of signal generator for particular measurement frequencies

The MS2721B spectrum analyzer is able to measure and present received signal power level directly in [dBm]. Using the same device during calibration phase and in final measurement campaign should compensate eventual received signal power measurement errors. The receiving section feeder attenuation values are presented in Table 5.

Frequency [GHz]	1	2	3	4
Feeder loss between antenna and spectrum analyzer [dB]	3.24	4.86	6.25	7.7

Table 5. Attenuation of receiver section feeder

Obviously, similar but not the same calibration procedure was repeated at frequency 0.5GHz after measurement campaign to obtain the power level at the input of transmitting antenna and attenuation of feeders for this specified frequency.

Because the receiving antenna has directional spatial characteristic, path loss measurement procedure required pointing the antenna in direction of transmitter in case of line of sight (LOS) condition or in direction of maximum received signal power in case of non-line of sight (NLOS) for every position of receiving section. To simplify the search of maximum signal direction, both transmit and receive antennas were fastened to movable masts with tripods, which allow to change azimuth of reception while height of antenna above terrain remained unchanged.

As the maximum transmitter output power was set to +30dBm and the transmitting antenna gain did not exceed 8dBi, the value of EIRP was far below 15W limit. According to Polish law, electromagnetic radiation sources with EIRP less than 15W are objects that do not affect environment or human, so nobody from the measurement team was exposed to harmful electromagnetic radiation.

To improve measurement speed and accuracy, data from spectrum analyzer (received signal power) and GPS receiver (geographic coordinates and time of each measurement) data were collected by notebook. Special software running on computer with Linux operating system allowed to define the time between successive measurements, frequency and bandwidth of received signal, type of applied power detector, additional averaging of results etc. It is also possible to record signal spectrum in each measurement point.

3.3 Path loss measurements in the Gdynia Container Terminal

With the help from administration of the Gdynia Container Terminal, complex survey of propagation aspect in container port was made in term from June to September 2007. Almost 5000 data sets were collected during measurement campaigns, which means about thousand measurement points for each analyzed frequency. The analyses were made in different weather conditions – sunny, cloudy and rainy days with temperature from 5°C to 20°C.

Exemplary results of propagation path loss measurements in area of container terminal are shown on map in Fig. 4, where blue rectangles symbolize stacks of containers, dots symbolize location of successive measurement points and colour of each dot indicates basic transmission loss in [dB].

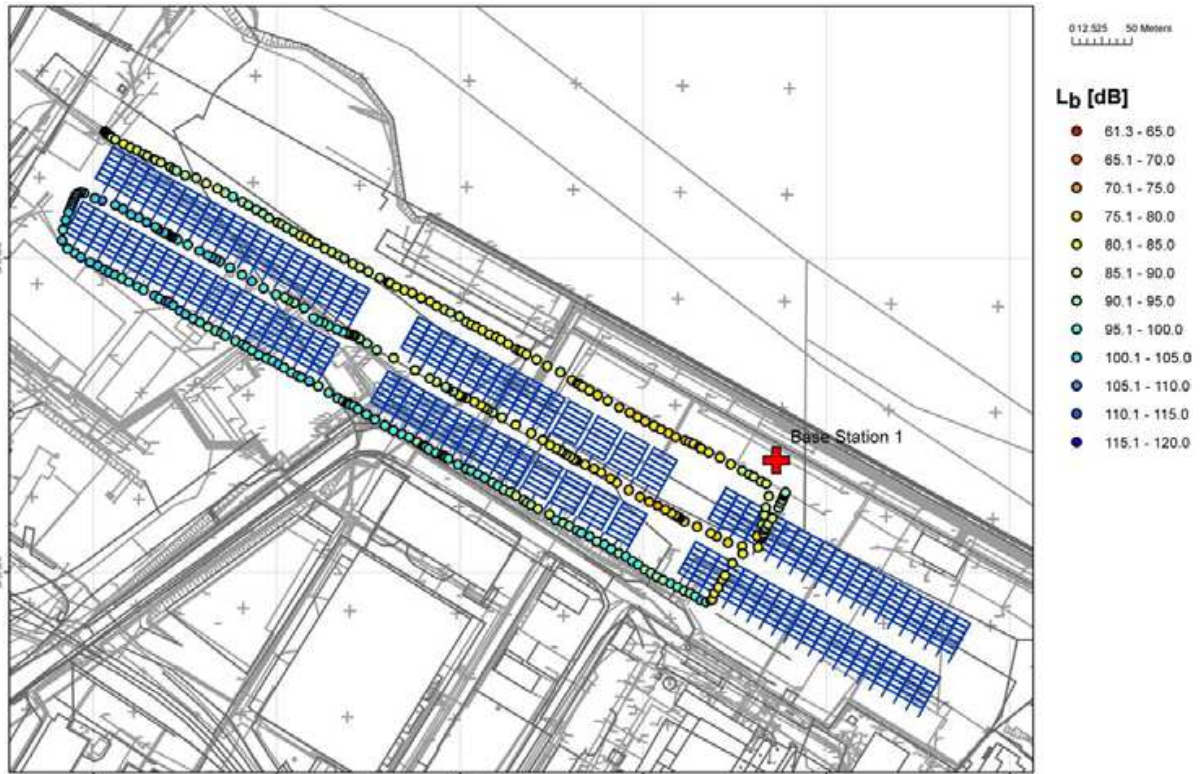

Fig. 4. Propagation path loss measurement results at 2GHz in the Gdynia Container Terminal

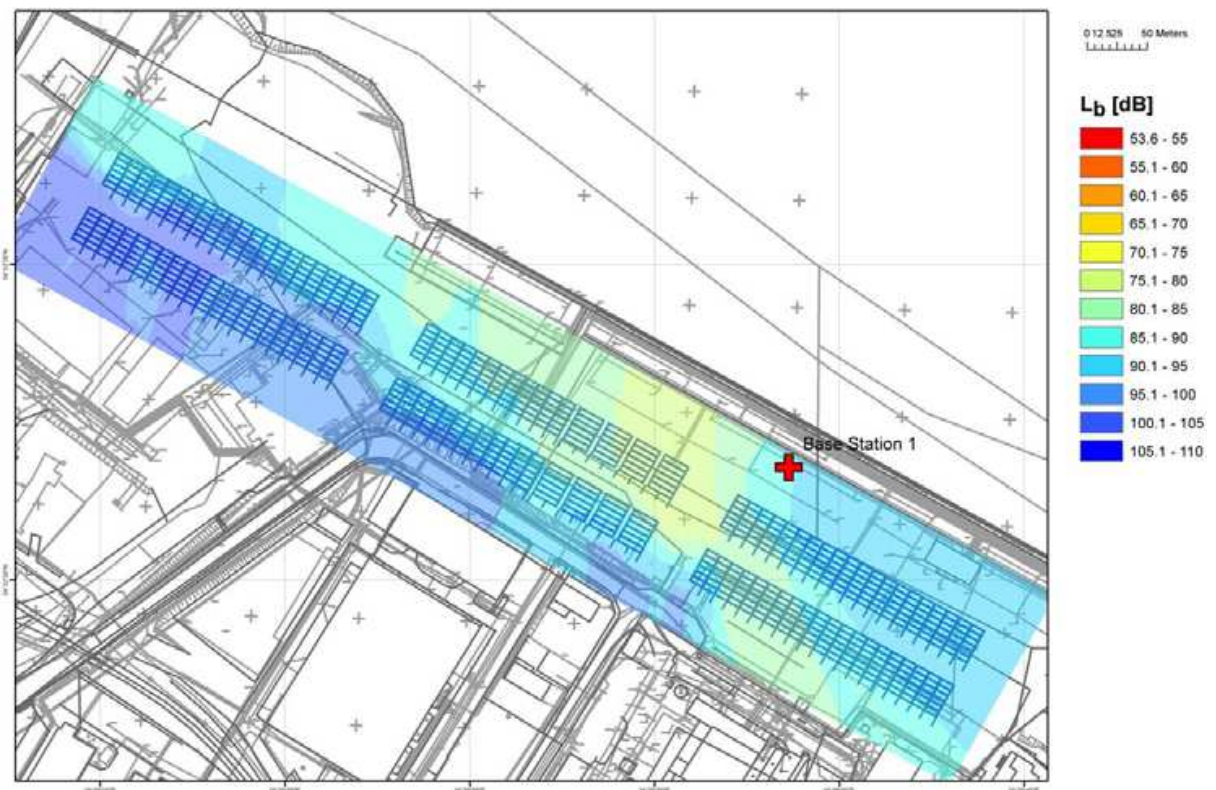

Fig. 5. Spatial interpolation of measurement results from Fig. 4

The next figure (Fig. 5) was created using spatial interpolation. This interpolation should be understood as a prediction of expected basic transmission loss in places where measurements were not possible. There are many different methods of spatial data interpolation. In this example inverse distance weighting (IDW) interpolation was used, which is based on weighted averaging of value from nearby measurement points. This method assumes, that the greatest impact on value in point of interpolation have these points of real measurements which are the closest, so the weight used in averaging process should be the inverse of distance between interpolation point and measurement point.

The value in the interpolation point is calculated by equation:

$$Z = \frac{\sum_{i=1}^n \frac{Z_i}{d_i^p}}{\sum_{i=1}^n \frac{1}{d_i^p}}, \quad (11)$$

where:

Z - value in interpolation point,

d_i - distance between i -th measurement point and interpolation point,

Z_i - value in i -th measurement point,

p - exponent (in our case $p=2$),

n - number of nearby measurement points used to interpolate values between points (in our case $n=12$).

The value of exponent p determines how the measurement points impact the interpolated value: the bigger value of p , the smaller impact to the interpolated value has the measurement points located farther from interpolation point. Therefore as the value of p is bigger, local variations of measured values are more visible in the results of interpolation.

The IDW method, briefly described above, was chosen because of spatial nature of collected data: measurement points were located closely (distance between neighboring point varies from one to several meters) so the IDW method allowed to distinguish local variation in path loss value. All the spatial analysis and interpolations were made using ArcView 9.2 geographic information system (GIS) software.

3.4 A novel multivariate empirical path loss model

Upon the results of almost 5 thousands propagation path measurements in real container terminal environment, a novel analytical model was developed using multidimensional linear regression analysis with multiple independent variables. For the sake of this analysis a multivariate error function was defined (Katulski & Kiedrowski, 2005). The following parameters, which should affect the value of propagation path loss in port area, were chosen as independent variables in error function:

- frequency f ,
- propagation path length d ,
- path type qualification: line of sight or non line of sight condition,
- difference between transmitter antenna height h_T above terrain level and average height h_{av} of container stack, but two possible cases should be investigated separately: $h_T \geq h_{av}$ and $h_{av} > h_T$.

Because the container terminal, in which all the measurements were made, was permanently used for container transportation, safety restrictions forced authors to limit the height h_R of

receiver antenna to fixed value equal 2m. Due to fixed value of receiver antenna height, proposed propagation models do not include this height as a variable parameter.

As a result of defined error function analysis, regression coefficients for respective propagation cases were computed. Based on this, analytical formulas of propagation path loss in container terminal area can be presented (Katulski et al., 2008).

Propagation path loss in [dB] in line of sight scenario:

a) in case, when $h_T \geq h_{av}$ (LOS1):

$$L_{LOS1} = 55.2 + 20 \log f + 5.8 \log d - 22.1 \log(h_T - h_{av}), \quad (12)$$

b) otherwise, when $h_{av} > h_T$ (LOS2):

$$L_{LOS2} = 41.9 + 20 \log f + 25.9 \log d + 4.2 \log(h_{av} - h_T). \quad (13)$$

Propagation path loss in non line of sight scenario:

a) in case, when $h_T \geq h_{av}$ (NLOS1):

$$L_{NLOS1} = 32.6 + 20 \log f + 7.9 \log d + 0.8 \log(h_T - h_{av}), \quad (14)$$

b) otherwise, when $h_{av} > h_T$ (NLOS2):

$$L_{NLOS2} = 38.6 + 20 \log f + 13 \log d + 5.9 \log(h_{av} - h_T). \quad (15)$$

The frequency f in equations (12) - (15) should be in [MHz], propagation distance d in [km], height of transmit antenna and average height of container stack in [m].

Mean error (ME) and mean square error (MSE) are commonly being used to verify accuracy of path loss models. These errors are defined by expression (16) and (17) respectively (Katulski & Kiedrowski, 2006):

$$ME = \frac{1}{N} \sum_{i=1}^N (L_{meas,i} - L_{reg,i}), \quad (16)$$

$$MSE = \sqrt{\frac{1}{N} \sum_{i=1}^N (L_{meas,i} - L_{reg,i})^2}, \quad (17)$$

where $L_{meas,i}$ is the value of measured path loss in i -th position of receiver equipment ($i=1, \dots, N$), $L_{reg,i}$ is the path loss value computed using equations (12) to (15) for i -th position, and N is the total number of considered results. Mean error value reflect the expected average difference between path loss values obtained using proposed model and real path loss measurement results, while mean square error is the ratio of dispersion of measured path loss values and describes how good the propagation model matches experimental data.

Mean errors and mean square errors for all the considered propagation path variants separately (different height of transmitter antenna, line of sight condition) and summary for all measurement results together, are presented in Table 6.

The propagation path loss calculated using proposed analytical model fits very well to the results from measurement campaign for all propagation path variants, which is confirmed by very low values of mean errors and acceptably low values of mean square errors.

LOS				NLOS				SUMMARY	
LOS1		LOS2		NLOS1		NLOS2			
ME	MSE	ME	MSE	ME	MSE	ME	MSE	ME	MSE
0.00	8.51	0.01	6.02	0.00	6.73	0.00	6.28	0.00	6.82
ME=0.01, MSE=7.22				ME=0.00, MSE=6.49					

Table 6. Mean errors and mean square errors for proposed propagation model

4. Future research in the DCT Gdansk Container Terminal

In order to generalize the path loss model for container terminal environments there was a necessity to carry out a wider research in other type of container terminal. It has been made in the DCT Gdansk Container Terminal (Poland). New multipurpose mobile equipment for propagation measurements allowed to carry out the research in accordance with described normative requirements.

Measurement equipment consists of two parts: immobile transmitting section (Fig. 6) and mobile receiving section (Fig. 7). These block diagrams exclude descriptions of devices types and feeders lengths.

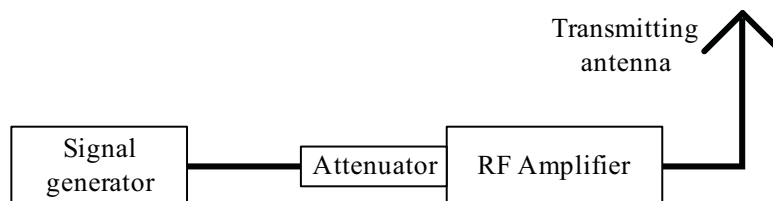

Fig. 6. Simplified block diagram of the immobile transmitting section

The transmitting section of the equipment for propagation measurements consists of signal generator connected to transmitting antenna through the RF amplifier and the attenuator. The generator is a source of the test signal, that is going to be investigated. The attenuator protects the amplifier from damage caused by high level signals. The signal generator and the amplifier are a source of test signal with power of P_{MT} (see Fig. 1), which is supplied to input terminals of transmitting antenna. The transmitting antenna is a monopole vertical antenna with electrical length of one-quarter of a wavelength. It has been developed and implemented in a manner, that allows to change its linear length, so it may be used for research on various frequencies. During the research antenna was installed on various heights, but always higher than 10 meters above a ground level (ITU-R SM.378-7, 2007), to minimize the influence of the Earth surface on the test signal attenuation.

In order to prepare the transmitting section for tests, the calibrating spectrum analyzer should be connected in place of the transmitting antenna in the same way as presented in Fig. 3. The desirable value P_t of test signal should be set by changing settings of the generator and RF amplifier and taking into account attenuation of the attenuator. It should be noted that the calibrated equipment should not be changed during the tests.

In mobile receiving section (Fig. 7), the spectrum analyzer is used as the measuring receiver. It is also equipped with a GPS receiver, which allows to determine the test vehicle position and assign it to appropriate measurement result. The receiving antenna is the same type as

the transmitting antenna. During the research the receiving antenna was installed at a height of 2 meters above ground level. The receiving section is carried by test vehicle (in our case a hand-cart). It is moving along a route of radio wave propagation with velocity not exceeding the value resulting from equation (9).

The rotary encoder is used to determine the distance from starting point and to determine the point where the measurement should be triggered. This encoder is connected to the test wheel and the encoder controller. For every distance of 0.8λ , the encoder controller sends an impulse to the industrial computer, which triggers next measurement of signal power P_{MR} at the receiver input. The industrial computer is responsible for the spectrum analyzer configuring, measurements triggering and recording its results. The LCD display shows the following data: current measurement result, distance from starting point, current velocity of test vehicle. Whole receiving section is powered by battery with sufficient capacity.

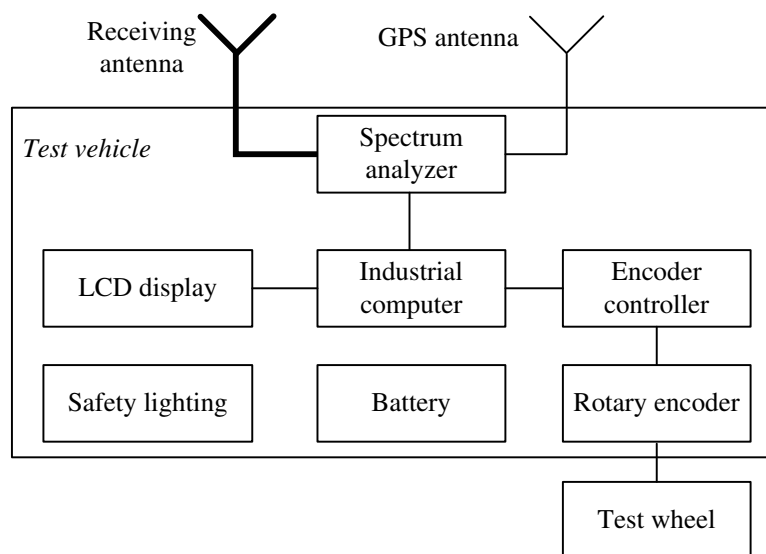

Fig. 7. Simplified block diagram of the mobile receiving section (Ambroziak, 2010)



Fig. 8. Measurement team during research in the DCT Gdansk Container Terminal

It is very important to ensure safety of measurement team during research in container environment. The DCT Port internal safety procedures required that all the objects moving between container stacks has to be clearly visible in all conditions. For this reason, the

receiving section is equipped with pulsing safety lighting to make the test vehicle more visible. This lighting is mounted in the highest point of the test vehicle, at the antenna mast. Fig. 8 presents measurement team from the Department of Radiocommunication Systems and Networks (Gdansk University of Technology) during measuring research on radio wave propagation in the DCT Gdansk Container Terminal (Poland).

5. Conclusion

The chapter presents the normative requirements concerning the methodology of measurement research on radio wave propagation and the measuring apparatus. This requirements are in accordance with current ITU-R Recommendations. On the basis of these recommendations there were carried out the propagation research in the container terminals in Gdynia and Gdansk. Radio propagation analysis in container terminal scenario, presented in this chapter, was the first such measurement in Poland and unique in the worldwide area of radio communication research.

Upon the analysis of path loss measurement data collected in the Gdynia Container Terminal, the novel container port area propagation model was proposed. This model has been verified in real propagation conditions in wide frequency range from 0.5GHz to 4GHz and can be used to predict propagation path loss in case of designing radio communication systems for container ports or even other related propagation environments.

During the research in the DCT Gdansk Container Terminal the data about nearly 290 thousand of propagation cases was collected. These cases concern the propagation routes with various lengths, various frequencies and various heights of transmitting antenna. The results of these research will be used for verification, extending and generalize new-elaborated propagation model for container terminals.

6. References

- Ambroziak, S.J. (2010). Measuring research on radio wave propagation - normative requirements (in Polish), *Telecommunication review and telecommunication news*, No. 2-3/2010, pp.84-89, ISSN: 1230-3496
- Barclay, L. (2003). *Propagation of radiowaves*, The Institution of Engineering and Technology, ISBN: 978-0-85296-102-5, London, United Kingdom
- ITU-R P.341-5 (1999). *The concept of transmission loss for radio links*
- ITU-R PN.525-2 (1994). *Calculation of free-space attenuation*
- ITU-R SM.1708 (2005). *Field-strength measurements along a rout with geographical coordinate registration*
- ITU-R SM.378-7 (2007). *Field-strength measurements at monitoring stations*
- Katulski, R.J. & Kiedrowski, A. (2005). *Empirical formulas for determination of the propagation loss in urban radio access links*, *Proceedings of IEEE 62nd Vehicular Technology Conference*, pp. 1742-1746, ISBN: 0-7803-9152-7, Dallas 25-28 September 2005, USA
- Katulski, R.J. & Kiedrowski, A. (2006). Propagation path loss modeling for fixed radio networks in urban scenario (in Polish), *Electronics and Telecommunications Quarterly*, vol. 52 no. 2, pp. 193-210, ISSN : 0867-6747
- Katulski, R.J.; Sadowski, J. & Stefanski, J. (2008). *Propagation Path Modeling In Container*

- Terminal Environment*, Proceedings of VTC 2008-Fall: IEEE 68th Vehicular Technology Conference, pp. 1-4, ISBN: 978-1-4244-1721-6, Calgary 21-24 September 2008, IEEE, Canada
- Katulski, R.J. (2009). *The radio wave propagation in wireless telecommunication* (in Polish), Transport and Communication Publishers, ISBN: 978-83-206-1749-8, Warsaw, Poland
- Katulski, R.J. et al. (2009). *Description of the system for cargo containers monitoring in a container terminal* (in Polish), Gdansk University of Technology, Faculty of Electronics, Telecommunications and Informatics, Department of Radiocommunication Systems and Networks, Scientific Report 5/2009
- Lee, William C.Y. (1993). *Mobile communications design fundamentals*, John Wiley & Sons, ISBN: 0-471-57446-5, New York, USA

IntechOpen

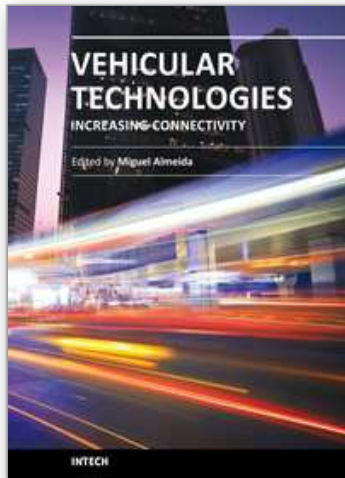

Vehicular Technologies: Increasing Connectivity

Edited by Dr Miguel Almeida

ISBN 978-953-307-223-4

Hard cover, 448 pages

Publisher InTech

Published online 11, April, 2011

Published in print edition April, 2011

This book provides an insight on both the challenges and the technological solutions of several approaches, which allow connecting vehicles between each other and with the network. It underlines the trends on networking capabilities and their issues, further focusing on the MAC and Physical layer challenges. Ranging from the advances on radio access technologies to intelligent mechanisms deployed to enhance cooperative communications, cognitive radio and multiple antenna systems have been given particular highlight.

How to reference

In order to correctly reference this scholarly work, feel free to copy and paste the following:

Slawomir J. Ambroziak, Ryszard J. Katulski, Jaroslaw Sadowski and Jacek Stefanski (2011). Propagation Path Loss Modelling in Container Terminal Environment, Vehicular Technologies: Increasing Connectivity, Dr Miguel Almeida (Ed.), ISBN: 978-953-307-223-4, InTech, Available from: <http://www.intechopen.com/books/vehicular-technologies-increasing-connectivity/propagation-path-loss-modelling-in-container-terminal-environment>

INTECH
open science | open minds

InTech Europe

University Campus STeP Ri
Slavka Krautzeka 83/A
51000 Rijeka, Croatia
Phone: +385 (51) 770 447
Fax: +385 (51) 686 166
www.intechopen.com

InTech China

Unit 405, Office Block, Hotel Equatorial Shanghai
No.65, Yan An Road (West), Shanghai, 200040, China
中国上海市延安西路65号上海国际贵都大饭店办公楼405单元
Phone: +86-21-62489820
Fax: +86-21-62489821

© 2011 The Author(s). Licensee IntechOpen. This chapter is distributed under the terms of the [Creative Commons Attribution-NonCommercial-ShareAlike-3.0 License](https://creativecommons.org/licenses/by-nc-sa/3.0/), which permits use, distribution and reproduction for non-commercial purposes, provided the original is properly cited and derivative works building on this content are distributed under the same license.

IntechOpen

IntechOpen