

We are IntechOpen, the world's leading publisher of Open Access books Built by scientists, for scientists

6,900

Open access books available

185,000

International authors and editors

200M

Downloads

Our authors are among the

154

Countries delivered to

TOP 1%

most cited scientists

12.2%

Contributors from top 500 universities



WEB OF SCIENCE™

Selection of our books indexed in the Book Citation Index
in Web of Science™ Core Collection (BKCI)

Interested in publishing with us?
Contact book.department@intechopen.com

Numbers displayed above are based on latest data collected.
For more information visit www.intechopen.com



Block Transmission Systems in Wireless Communications

Mutamed Khatib
Palestine Technical University
Palestine

1. Introduction

In block transmission systems, the data symbols are grouped in the form of blocks of certain length separated by blocks of known symbols (Kaleh 1995). The receiver for this kind of systems is the Non-linear Data Directed Estimator (NDDE) introduced in (Perl et al. 1987; Crozier et al. 1992).

Block transmission systems are based on the assumption that the channel should be constant within the block, which means that the block duration must be sufficiently short in comparison with the channel profile (Kaleh 1995).

Block Linear Equalizer (BLE) has been proposed in (Crozier et al. 1992; Kaleh 1995; Ghani 2003; Hayashi & Sakai 2006) for transmitting digital data over time varying and time dispersive channels. The system is a synchronous serial data transmission system that employs transmission of alternating blocks of data and training symbols (Kaleh 1995). In contrast to the recursive symbol-by-symbol detection approach usually employed, each data block is detected as a unit (Ghani 2003). This system requires an estimate of the channel impulse response and assumes that it remains unchanged during the transmission of a block of data symbols.

BLE system has advantages over the conventional linear and nonlinear equalizer in that the channel is always equalized exactly and there are no error extension effects. Although the transmission efficiency is reduced due to the addition of training symbol blocks between consecutive data blocks, this disadvantage is more than offset in comparison to the advantages offered by the system (Ghani 2003).

In this chapter, some block linear equalizers are introduced, where each impulse at the input to the transmitter is the corresponding input signal element and it may be either binary or multilevel. The signal elements are assumed to be antipodal and statistically independent. The linear baseband channel has an impulse response $y(t)$ and includes all transmitter and receiver filters used for pulse shaping and linear modulation and demodulation. The impulse response $h(t)$ of the transmitter and receiver filters in cascade is assumed to be such that:

$$h(t) = \begin{cases} 1 & t = 0 \\ 0 & t \neq 0 \end{cases} \quad (1)$$

2. Block linear equalizer

The main block diagram of the BLE is shown in Fig.1. White Gaussian noise with zero mean and a two sided power spectral density of σ^2 is added at the output of the transmission path, giving the zero mean Gaussian waveform $w(t)$ at the output of the receiver filter, hence the received signal is:

$$r(t) = \sum_i s_i y(t - iT) + w(t) \quad (2)$$

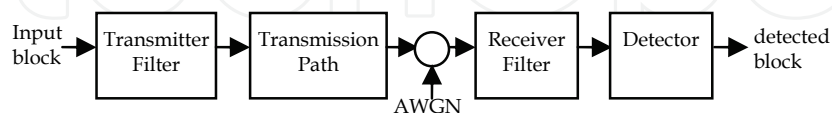

Fig. 1. Model of the Block transmission system (Ghani 2003)

The received signal at the output of the receiver filter is sampled at time instant $t = iT$, where T is the symbol interval. In this block transmission system, consecutive blocks of m information symbols at the input to the transmitter filter are separated by blocks of g zero level symbols as shown in Fig. 2, where g is the largest memory length of the channel $y(t)$, and $y = [y_0 \ y_1 \ \dots \ y_g]$ is the sampled impulse response (Ghani 2003).

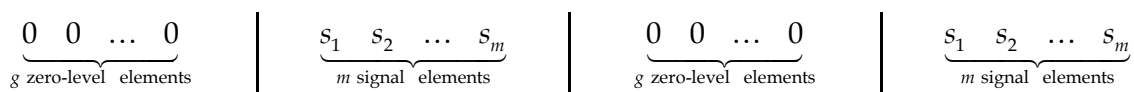

Fig. 2. Structure of transmitted signal elements in Block System (Ghani 2003)

For each received group of m signal-elements there are $n = m + g$ sample values at the detector input that are dependent only on the m elements and independent of all other elements. The detector uses these n values in the detection of the symbol block. The detected values are then used for the estimation of the channel sampled impulse response using the same equipment (Ghani 2003; Ghani 2004).

If only the i^{th} signal-element in a group is transmitted, in the absence of noise and with s_i set to unity, the corresponding received n sample values used for the detection of m elements of a group are given by the n -component row vector:

$$\mathbf{Y}_i = \underbrace{0 \ \dots \ 0}_{i-1} \ \underbrace{y_0 \ y_1 \ \dots \ y_g}_{g+1} \ \underbrace{0 \ \dots \ 0}_{m-i} \quad (3)$$

Where y_h must be non-zero for at least one element in the range 0 to g . The sum of the m received signal elements in a group and in the absence of noise is therefore, given by:

$$\mathbf{R} = \sum_{i=1}^m s_i \mathbf{Y}_i = \mathbf{S} \mathbf{Y} \quad (4)$$

Where \mathbf{S} is the m -component row vector whose i^{th} component is s_i and represents the transmitted signal block. \mathbf{Y} is an $m \times n$ matrix whose i^{th} row \mathbf{Y}_i is given by Eq. 3. Since at least one of the y_h is non-zero, the rank of the matrix \mathbf{Y} is always m , and hence, the m rows

of the matrix \mathbf{Y} are linearly independent. Note that the sampled impulse response of the channel completely determines the matrix \mathbf{Y} (Ghani 2004).

In the presence of noise, the sample values corresponding to a received signal block at the detector input is given by the vector \mathbf{R} where (Ghani 2003; Ghani 2004):

$$\mathbf{R} = \mathbf{S}\mathbf{Y} + \mathbf{W} \quad (5)$$

Where \mathbf{W} is the n -component noise vector whose components are sample values of statistically independent Gaussian random variable with zero mean and variance σ^2 .

The vectors \mathbf{R} , $\mathbf{S}\mathbf{Y}$ and \mathbf{W} can be represented as points in the n -dimensional Euclidean signal space. Assume that the detector has prior knowledge of \mathbf{Y}_i , but has no prior knowledge of the s_i or σ^2 . A knowledge of the \mathbf{Y}_i of course implies a knowledge of the channel impulse response. Since the detector knows \mathbf{Y} , it knows the m -dimensional subspace spanned by \mathbf{Y}_i and hence the subspace containing the vector $\mathbf{S}\mathbf{Y}$, for all s_i . Since the detector has no prior knowledge of s_i , it must assume that any value of \mathbf{S} is as likely to be received as any other, and in particular, as far as the detector is concerned, s_i need not be ± 1 . For a given vector \mathbf{R} the most likely value of $\mathbf{S}\mathbf{Y}$ is now at the minimum distance from \mathbf{R} . Clearly, if \mathbf{R} lies in the subspace spanned by the \mathbf{Y}_i , then the most likely value of $\mathbf{S}\mathbf{Y}$ is \mathbf{R} . In general, \mathbf{R} will not lie in this sub-space. In this case, the best estimate the detector can make of \mathbf{S} is the m -component vector \mathbf{X} , whose components may have any real values, and are such that $\mathbf{X}\mathbf{Y}$ is at the minimum distance from \mathbf{R} . By the projection theorem (Varga 1962), $\mathbf{X}\mathbf{Y}$ is the orthogonal projection of \mathbf{R} onto the m -dimensional subspace spanned by the \mathbf{Y}_i . It follows that $\mathbf{R} - \mathbf{X}\mathbf{Y}$ is orthogonal to each of the \mathbf{Y}_i , so that (Ghani 2003; Ghani 2004):

$$(\mathbf{R} - \mathbf{X}\mathbf{Y})\mathbf{Y}^T = 0 \quad (6)$$

In other words,

$$\mathbf{X} = \mathbf{R}\mathbf{Y}^T(\mathbf{Y}\mathbf{Y}^T)^{-1} \quad (7)$$

Thus, if the received signal vector \mathbf{R} is fed to the n input terminals of the linear network $\mathbf{Y}^T(\mathbf{Y}\mathbf{Y}^T)^{-1}$, the signals at the m output terminals are the components x_i of the vector \mathbf{X} , where \mathbf{X} is the best linear estimate the detector can make of \mathbf{S} . Thus:

$$\mathbf{X} = \mathbf{R}\mathbf{Y}^T(\mathbf{Y}\mathbf{Y}^T)^{-1} = \mathbf{S} + \mathbf{U} \quad (8)$$

The m vector \mathbf{U} is the noise vector at the output of the network $\mathbf{Y}^T(\mathbf{Y}\mathbf{Y}^T)^{-1}$. Each component u_i of the noise vector \mathbf{U} is a sample value of a Gaussian random variable with a variance not equal to σ^2 , and which differ from one component to another (Ghani 2003; Ghani 2004). In the final stage of the detection process, the receiver examines the signs of the x_i and allocates the appropriate binary values to the corresponding signal elements, to give the detected value of \mathbf{S} . The detector requires no prior knowledge of the received signal level and is linear up to the decision process just mentioned. It can be seen that in the linear $n \times m$ network $\mathbf{Y}^T(\mathbf{Y}\mathbf{Y}^T)^{-1}$, \mathbf{Y}^T represents a set of m matched filters or correlation detectors tuned

to the m \mathbf{Y}_i whose m outputs feed the inverse network represented by the matrix $(\mathbf{Y}\mathbf{Y}^T)^{-1}$ (Ghani 2003). The probability of error for the block linear equalizer is: (Hsu 1985; Perl et al. 1987; Crozier et al. 1992):

$$P_e = \frac{1}{2} \operatorname{erfc} \left(\frac{1}{\eta} \sqrt{\frac{E_b}{N_o}} \right) \quad (9)$$

where η^2 is the effect of the linear matrix $\mathbf{Y}^T (\mathbf{Y}\mathbf{Y}^T)^{-1}$ on the AWGN vector.

3. Channel Impulse Response (CIR)

Table 1 shows some FIR channels with their normalized vectors, and norm values (Kaleh 1995; Proakis 1995; Ghani 2003). Channels usually normalized when studying transmission systems, especially when there is comparison between different transmission systems. This will not affect the behavior of the channel, but prevent any possible bias in the results.

The vector $[0.235 \ 0.667 \ 1 \ 0.667 \ 0.235]$ represents the sampled impulse response for a channel with moderate amplitude distortion as shown in Fig. 3 (b) (Ghani 2003). It is preferred to be used in this chapter because its length as it is useful to compare long channels with shorter ones. Channel vector $[0.707 \ 1 \ 0.707]$ represents a channel with severe distortions as shown in Fig. 3 (d). It is used here because it has the same norm as the vector $[0.235 \ 0.667 \ 1 \ 0.667 \ 0.235]$, but with less length. This makes it good choice to be compared with $[0.235 \ 0.667 \ 1 \ 0.667 \ 0.235]$ without worrying about the norm effect.

Channel vector	Channel after normalization	Norm
$[0.235 \ 0.667 \ 1 \ 0.667 \ 0.235]$	$[0.166 \ 0.472 \ 0.707 \ 0.472 \ 0.166]$	1.4143
$[0.707 \ 1 \ 0.707]$	$[0.5 \ 0.707 \ 0.5]$	1.4141
$[0.5 \ 1 \ -0.5]$	$[0.408 \ 0.816 \ -0.408]$	1.2247
$[0.5 \ 1 \ 0.5]$	$[0.408 \ 0.816 \ 0.408]$	1.2247
$[1 \ 2 \ 1]$	$[0.408 \ 0.816 \ 0.408]$	2.4495
$[0.707 \ 2.234 \ 0.707]$	$[0.289 \ 0.913 \ 0.289]$	2.4494

Table 1. Wireless channel models (Kaleh 1995; Proakis 1995; Ghani 2003)

The channel given by the vector $[1 \ 2 \ 1]$ is one of worst channels that may affect the transmitted signal because it has second order null in frequency domain, and introduces severe signal distortion (Kaleh 1995). This channel characteristics are shown in Fig. 3 (j). Channel vector $[0.5 \ 1 \ 0.5]$ is used as it has the same normalized vector as $[1 \ 2 \ 1]$, the difference is in the amplitude. So, it is suitable to study the effect of the channel amplitude. Also, $[0.5 \ 1 \ -0.5]$ is a useful channel in comparison as it is the same like $[0.5 \ 1 \ 0.5]$, but with a reversed sign at one of the elements. So, it is suitable for the symmetry test.

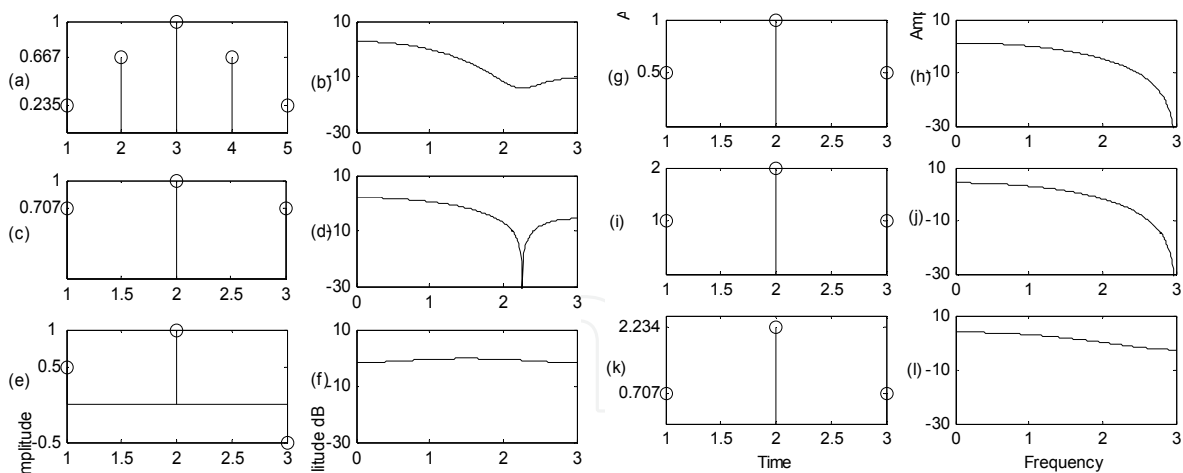

Fig. 3. Impulse responses and amplitude spectrums for channels in Table 1

4. Precoding of transmitted signal

A new technique is developed in this section, which is suitable for downlink band-limited ISI channels. This technique reduces the complexity of the receiver in which the detection process needs only a threshold decision to retrieve the transmitted data, no match filtering or any other processing is needed. In the base station, a precoder is used to generate a code from the transmitted signal that makes it immune to the channel, so, there is no need for any further equalization process in the receiver that reduces the mobile unit receiver to a decision process due to a certain threshold testing. It depends on the channel's prior knowledge at the base station, so, the channel characteristics are assumed to be known both at the transmitter and the receiver. When comparing the process of adding a coder at the base station with the simplicity gained at the receiver units, it will be acceptable because few base stations serve many receiver units in the downlink.

4.1 System model

The system considered is shown in Fig. 4. The signal at the input to the transmitter is a sequence of k -level element values $\{s_i\}$, where $k = 2, 4, 8, \dots$ and the $\{s_i\}$ being statistically independent and equally likely to have any of the possible values. The buffer-store at the input to the transmitter holds m successive element values $\{s_i\}$. In the coder, the $m \{s_i\}$ are converted into the corresponding m coded signal-elements. The coder performs a linear transformation on the $m \{s_i\}$ to generate the corresponding sequence of impulses that is fed to the baseband channel $y(t)$ which is assumed that it is either time invariant or varies slowly with time.

White Gaussian noise, with zero mean and variance σ^2 , is assumed to be added to the data signal at the output of the transmission path, giving the Gaussian waveform $w(t)$ added to the data signal.

The sampled impulse-response of the baseband channel is given by the $(g+1)$ component row vector as explained in Section 2.

The received waveform $r(t)$ at the output of the baseband channel is sampled at the time instants $\{iT\}$, for all integers $\{i\}$. The $\{r_i\}$ are fed to the buffer store which contains two separate stores. While one of these stores holds a set of the received $\{r_i\}$ for a detection

process, the other store is receiving the next set of $\{r_i\}$ in preparation for the next detection. A group of m elements are detected simultaneously in a single detection process, from the set of $\{r_i\}$ that depends only on these elements. The receiver uses the knowledge of the $\{y_i\}$ and the possible values of $\{s_i\}$ in the detection of the m element values $\{s_i\}$ from the received samples $\{r_i\}$. A period of nT is available for the detection process, n is given by:

$$n = m + g \quad (10)$$

where m is the block length, and g is the channel length -1.

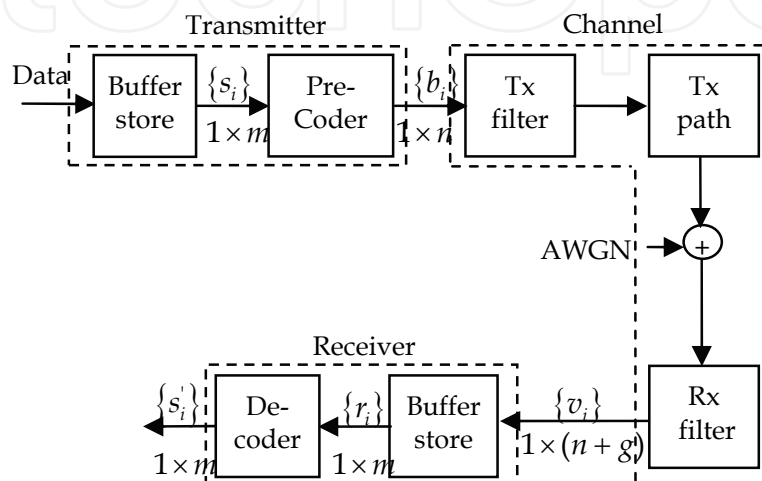

Fig. 4. The downlink of the precoding system

Except where otherwise stated, the decoder in Fig. 4 determines from the appropriate set of received $\{r_i\}$ the m estimated $\{x_i\}$ of the m element-values $\{s_i\}$ in a received group of elements. Each x_i is an unbiased estimate of the corresponding s_i such that:

$$x_i = s_i + u_i \quad (11)$$

where u_i is a zero mean Gaussian random variable. The detector detects each s_i by testing the corresponding x_i against a threshold. The detected value of s_i is designated as s'_i .

4.2 Design and analysis of the precoder

In this system, using buffer store, an $1 \times m$ vector $\mathbf{S} = [s_1 \ s_2 \ \dots \ s_m]$ is formed from the symbols to be transmitted. This vector is coded at the transmitter. The coder accepts the input vector \mathbf{S} and codes it to form the $1 \times n$ signal vector \mathbf{B} , which is the convolution between the input vector \mathbf{S} and the $m \times n$ coder matrix \mathbf{F} , i.e.:

$$\mathbf{B} = \sum_{i=1}^m \mathbf{s}_i \mathbf{F}_i = \mathbf{S} \mathbf{F} \quad (12)$$

where \mathbf{F}_i is the n component row vector.

This convolution process will add a time gap of gT seconds between each pair of adjacent groups of m signal-elements. Then, the output values from the coder multiplexer are fed to the baseband channel. At the receiver, the sample values of the received signal,

corresponding to a single group of m signal elements, will normally be a sequence of $n + g$ non-zero sample values. The sequence of these $n + g$ values in the absence of noise is:

$$v_i = \sum_{j=1}^n b_j y_{i-j} \quad i = 1, 2, \dots, n + g \quad (13)$$

Taking a practical example to clarify the convolution here, if $m = 2$, and $g = 1$, so $n = 3$ and $n + g = 4$. The output of the channel will be the 1×4 vector \mathbf{V} whose elements are:

$$\mathbf{V} = [b_1 y_0 + b_2 y_{-1} + b_3 y_{-2} \quad b_1 y_1 + b_2 y_0 + b_3 y_{-1} \quad b_1 y_2 + b_2 y_1 + b_3 y_0 \quad b_1 y_3 + b_2 y_2 + b_3 y_1] \quad (14)$$

Applying the limitations on the channel impulse response, \mathbf{V} may be written as:

$$\mathbf{V} = [b_1 y_0 + b_2 0 + b_3 0 \quad b_1 y_1 + b_2 y_0 + b_3 0 \quad b_1 0 + b_2 y_1 + b_3 y_0 \quad b_1 0 + b_2 0 + b_3 y_1] \quad (15)$$

So, this result is multiplication of \mathbf{B} by a 3×4 matrix \mathbf{C} that depends on:

$$\mathbf{C} = \begin{bmatrix} y_0 & y_1 & 0 & 0 \\ 0 & y_0 & y_1 & 0 \\ 0 & 0 & y_0 & y_1 \end{bmatrix} \quad (16)$$

In vector form, it may be written as:

$$\mathbf{V} = \mathbf{BC} \quad (17)$$

where \mathbf{V} is the $1 \times (n + g)$ received signal, and \mathbf{C} is the $n \times (n + g)$ channel with i^{th} row is:

$$\mathbf{C}_i = \overbrace{0 \quad \dots \quad 0}^{i-1} \quad \overbrace{y_0 \quad y_1 \quad \dots \quad y_g}^{g+1} \quad \overbrace{0 \quad \dots \quad 0}^{n-i} \quad (18)$$

Assume now that successive groups of signal-elements are transmitted, and one of these groups is that just considered. The first transmitted impulse of the group occurs at time T seconds. Fig. 5 shows the $n + g$ received samples which are the components of \mathbf{V} .

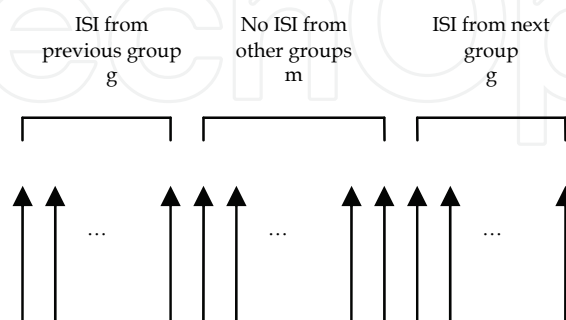

Fig. 5. Sequence of $n + g$ samples for one received block

Due to the Inter Block Interference (IBI), the first elements of the block (g components) of \mathbf{V} are affected in part on the preceding received group of m signal-elements. Also, the last g components of \mathbf{V} are dependent in part on the following received group of m elements. Thus

there is Intersymbol Interference (ISI) from adjacent received groups of elements in both the first and the last g components of \mathbf{V} . However, the central m components of \mathbf{V} depend only on the corresponding transmitted group of m elements, and can therefore be used for the detection of these elements without ISI from adjacent groups.

Returning back to the same example of $m = 2$ and $g = 1$, the central m components of \mathbf{V} are:

$$\mathbf{V}_{\text{central}} = [b_1 y_1 + b_2 y_o + b_3 0 \quad b_1 0 + b_2 y_1 + b_3 y_o] \quad (19)$$

which is the multiplication of \mathbf{B} by a 3×2 matrix that depends on the channel, and equal to:

$$\frac{\mathbf{V}_{\text{central}}}{\mathbf{B}} = \begin{bmatrix} y_1 & 0 \\ y_o & y_1 \\ 0 & y_o \end{bmatrix} \quad (20)$$

Mathematically, if only the central m components of \mathbf{V} are wanted, this matrix now represents the channel (mathematically only). To make this matrix somehow looks like the matrix \mathbf{C} , this matrix is the transpose of a new 2×3 matrix \mathbf{D} that is equal to:

$$\mathbf{D} = \begin{bmatrix} y_1 & y_o & 0 \\ 0 & y_1 & y_o \end{bmatrix} \quad (21)$$

In general, the central m components of the vector \mathbf{V} , $[v_{g+1} \quad v_{g+2} \quad \dots \quad v_{g+m}]$, can be obtained by introducing a new matrix \mathbf{BD}^T where \mathbf{D} is the $m \times n$ matrix of rank m whose i^{th} row is:

$$\mathbf{D}_i = \overbrace{0 \quad \dots \quad 0}^{i-1} \quad \overbrace{y_g \quad y_{g-1} \quad \dots \quad y_o}^{g+1} \quad \overbrace{0 \quad \dots \quad 0}^{m-i} \quad (22)$$

Thus, \mathbf{BD}^T is a $1 \times m$ vector where each row of it gives information about the received symbols at that row:

$$\mathbf{BD}^T = [v_{g+1} \quad v_{g+2} \quad \dots \quad v_{g+m}] \quad (23)$$

When noise is present, the received vector is:

$$\mathbf{R} = \mathbf{BD}^T + \mathbf{W} \quad (24)$$

It may be easily shown that the coder matrix \mathbf{F} has to be:

$$\mathbf{F} = (\mathbf{DD}^T)^{-1} \mathbf{D} \quad (25)$$

Thus, under the assumed conditions, the linear network \mathbf{F} representing the transformation performed by the coder is such that it makes the m signal elements of a group orthogonal at the input of the detector and also maximizes the tolerance to additive white Gaussian noise in the detection of these signal elements.

Now the block diagram of the precoding system, using the new assumptions about the precoder and the channel matrix, may be re-drawn as in Fig. 6.

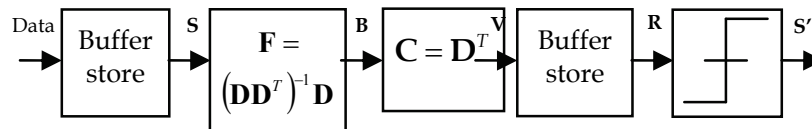

Fig. 6. Block diagram of the precoding system in vector form

4.3 Performance evaluation of the precoding system

Assume that the possible values of s_i are equally likely and that the mean square value of \mathbf{S} is equal to the number of bits per element. Suppose that the m vectors $\{\mathbf{D}_i\}$ have unit length. Since there are m k -level signal elements in a group, the vector \mathbf{S} has k^m possible values each corresponding to a different combination of the m k -level signal-elements. So, the vector \mathbf{B} whose components are the values of the corresponding impulses fed to the baseband channel, has k^m possible values. If e is the total energy of all the k^m values of the vector \mathbf{B} , then in order to make the transmitted signal energy per bit equal to unity, the transmitted signal must be divided by:

$$\ell = \sqrt{\frac{e}{nk^m}} \quad (26)$$

The m samples of the received signal from which the corresponding $\{s_i\}$ are detected, are:

$$\mathbf{R}' = \frac{1}{\ell} \mathbf{B} \mathbf{D}^T + \mathbf{W} \quad (27)$$

Then, the m sample values which are the components of the vector \mathbf{V} (after taking only the central m components), must first be multiplied by the factor ℓ to give the \mathbf{m} vector:

$$\mathbf{R} = \ell \mathbf{V} = \mathbf{B} \mathbf{D}^T + \ell \mathbf{W} = \mathbf{S} + \mathbf{U} \quad (28)$$

where \mathbf{U} is an m vector that represents the AWGN vector after being multiplied by ℓ . The mean of the new noise vector \mathbf{U} is zero and its variance is:

$$\eta_r^2 = \ell^2 \sigma^2 \quad (29)$$

Thus, the tolerance to noise of the system is determined by the value of η_r^2 . When there is no signal distortion from the channel, $(\mathbf{D} \mathbf{D}^T)^{-1}$ is an identity matrix. Under these conditions, $\ell = 1$, so that $\eta_r^2 = \sigma^2$.

Now, the block diagram can be finally drawn as:

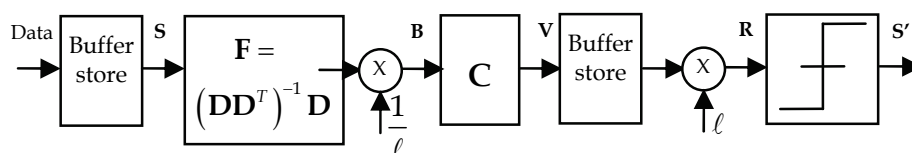

Fig. 7. Final block diagram of the precoding system

Note that the $m \times n$ network transforms the transmitted signal such that the corresponding sample values at the receiver are the best linear estimates of the $\{s_i\}$. The variance now is η_T instead of σ . So, the bit error rate equation may be written as:

$$P_e = \frac{1}{2} \operatorname{erfc} \left[\frac{\sqrt{\xi_b}}{\sqrt{2\eta_T}} \right] = \frac{1}{2} \operatorname{erfc} \left[\frac{1}{\ell} \sqrt{\frac{\xi_b}{N_o}} \right] \quad (30)$$

4.4 Numerical results of the precoding system

The bit error rate curves for the precoding system is shown in Fig. 8 (a). The signal elements are binary antipodal having possible values as +1 or -1. There are four elements in a group (block length $m = 4$) and these are equally likely to have any of the two values. The sampled impulse response of the channel is $\{y_i\} = [0.408 \ 0.817 \ 0.408]$. This channel has a second order null in the frequency domain and introduces severe signal (amplitude) distortion.

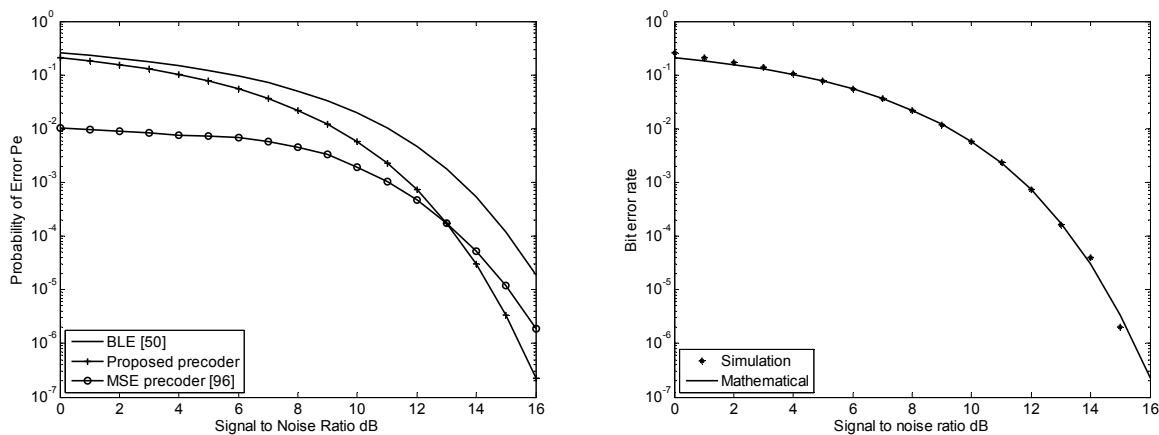

Fig. 8. (a) Probability of bit error versus SNR for the precoding system, (b) Mathematical and simulation results for the precoding system

The curves in Fig. 8 (a) were obtained by plotting the results of Eq. 30 for the proposed precoding system, Eq. 9 for the BLE and simulating the MSE precoder. In proposed precoder and the BLE, the same block length, and channel impulse response (CIR) were assumed. CIR was normalized to avoid any possible bias. From Fig. 5.1, it is clear that the proposed precoding system returns in about 2 dB enhancement in comparison with the BLE. The MSE linear precoder is simulated using 4 transmitted antennas and 2 receivers with 8 bits per user. The performance of the MSE precoder is better than the proposed precoder because 2 receivers are used. For high SNRs, the performance of the proposed precoder starts to be better than the MSE precoder because the MSE precoder uses a built in estimator. This estimator depends on pilot symbols, which will be affected by noise, and will return some inaccuracy in the channel estimation.

The precoding system has better performance than the block linear equalizer, each one of them provides the best linear estimate of a received group of m signal elements. In the block linear equalizer, all the signal processing is carried out at the receiver, while in the proposed precoding system, all the processing is done at transmitter, and leaves the receiver simple.

The proposed system depends on transmitting the data in blocks. The source of these data may be serial, i.e. from the same source, or even parallel from different sources. So, the length on the block is expected to have a great effect on the performance.

Simulation program is developed by Matlab. It is assumed that the channel characteristics are known, and fixed for all the transmission procedure. Channel impulse response may vary through the transmission, but it must be fixed within the block, and it should be known all the time. A certain estimation method is not suggested, but literature is rich with many methods, and any adaptive one may be used.

In order to make a comparison between the mathematical results for the precoding system presented in Fig. 8 (a), and the simulation program results, Fig. 8 (b) is introduced, which clarify that the behavior is the same.

Fig. 9 (a) shows the probability of error of the system for different values of SNR using four different lengths of the block, i.e. $m=1$, $m=2$, $m=4$ and $m=8$, the channel here is assumed to have impulse response $Y = [0.408 \ 0.817 \ 0.408]$.

It is clear from the figure that increasing the block length will reduce the performance of the system and the probability of error becomes worse. This result is expected because increasing the block length will increase the value of the transmitted vector energy ℓ , which maximizes the variance of the noise \mathbf{U} at the output of the system as given in Eq. 29.

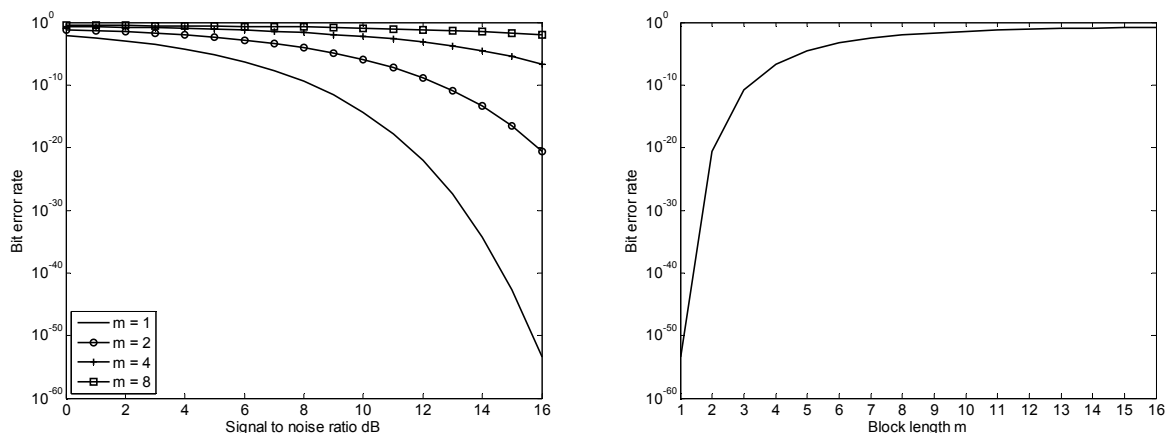

Fig. 9. (a) Effect of block length on the precoding system performance, (b) Behavior of the precoding system of different block lengths

Also, increasing the block length will increase the intersymbol interference inside the block itself (IBI between the blocks is removed by using guard band). Theoretically, the best result will be for $m=1$, which means transmitting each bit separately, and this is practically not accepted because in this case, each bit will use g bits as a guard band, and this is a great loss in the bandwidth. So, one must find an optimum solution for the block length.

In order to show the effect of various block lengths on the performance of the system, in Fig. 9 (b), there is a plot for continuous values of m under the same channel for different signal to noise ratios. From the curve, it is clear, not only that the system has better performance for short blocks, but also that the behavior will be almost stable for long codes, and the block length will not affect too much on the system.

There is no way to control the channel characteristics in the atmosphere, but at least, it is possible to decide whether to recommend the system in this area or not. So, some further tests are made to show the effect of the channel parameters on the system performance.

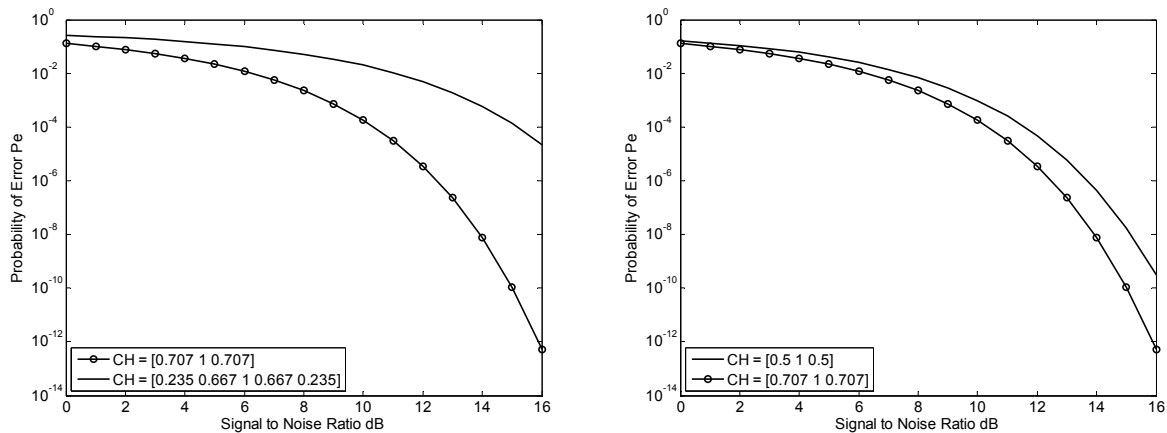

Fig. 10. (a) Effect of channel length on the precoding system, (b) Effect of channel variance on the precoding system

In Fig. 10 (a), the effect of the channel length on the performance of the system is studied. Here, two different channels are used with different lengths, the first channel is [0.707 1 0.707] with $g=2$ while the second channel has $g=4$, i.e. [0.235 0.667 1 0.667 0.235], both of them have the same norm values, as shown in Table 1, and they both have a bad amplitude spectrum as given in Fig. 3 (b),(d).

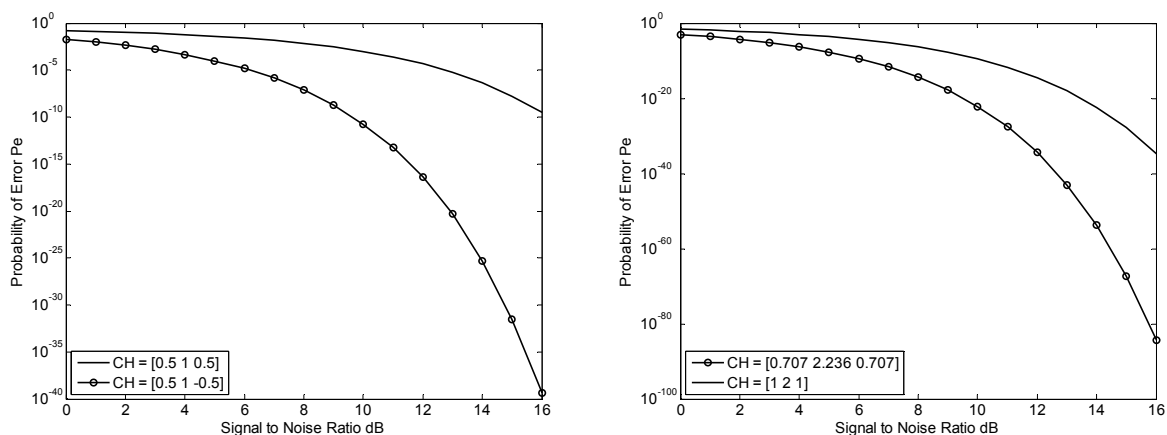

Fig. 11. (a) Effect of channel symmetry on the precoding system, (b) Effect of channel amplitude on the precoding system

Although increasing the channel length will give the system more guard band to reduce IBI, and despite of the fact that the amplitude spectrum for the longer channel is better than shorter one, it is noticed that the shorter channel is better than the longer one.

This is because increasing the channel length will increase the variance ℓ of the $m \times n$ precoder matrix \mathbf{F} too, affecting an increase in the noise variance η_T^2 at the receiver.

Note that the channel itself has no direct effect on the system as shown in Eq. 28.

It is clear from Table 2 that the value of ℓ is much higher for the long channel than the short one, which gives a good explanation for the better performance of the shorter one because the noise variance will be high for the long channel in comparison with the short channel.

Channel vector	ℓ^2			
	$m = 1$	$m = 2$	$m = 4$	$m = 8$
[0.235 0.667 1 0.667 0.235]	0.1	0.5182	4.7725	15.5051
[0.707 1 0.707]	0.1667	0.5001	1.5694	3.0711
[0.5 1 -0.5]	0.2222	0.3333	0.4571	0.5571
[0.5 1 0.5]	0.2222	0.6000	2.0825	9.6000
[1 2 1]	0.0556	0.1500	0.5206	2.4000
[0.707 2.234 -0.707]	0.0556	0.1154	0.2090	0.2970

Table 2. The normalization factors for channels in the precoding system

Then, the effect of the channel norm value on the performance of the system is tested, as shown in Fig. 10 (b). Here, two channels that differ in variance are used, but similar in length, i.e. $\mathbf{CH}_1 = [0.707 \ 1 \ 0.707]$ with variance 1.4141, and $\mathbf{CH}_2 = [0.5 \ 1 \ 0.5]$ with variance 1.2247 as given in Table 1. It is clear that the channel with high variance (norm) has better performance than that with low variance. The channel will not affect the received data directly, it affects the matrix \mathbf{D} which depends on the channel parameters as given in Eq. 22. So, ℓ will differ as shown in Table 2 giving more noise in the channel with low norm.

Making a look on the effect of the channel symmetry, as in Fig. 11 (a), typical channels, with the same length g and the same norm, are used as given in Table 1, but the sign of one of them is reversed at one side, i.e. $[0.5 \ 1 \ 0.5]$ and $[0.5 \ 1 \ -0.5]$. Asymmetric channels gave better performance than symmetric one. It is not strange because the symmetric channel increases the energy of the transmitted signal with a great ratio more than the asymmetric. Also, Fig. 3 (f) shows that the asymmetric one has a good amplitude spectrum too.

The amplitude of the channel will has its effect too. Fig. 11 (b) is an example, two channels are used : $\mathbf{CH}_1 = [0.707 \ 2.234 \ 0.707]$, and $\mathbf{CH}_2 = [1 \ 2 \ 1]$, both of them have the same length, the same variance, but with different amplitude. The first channel gave better performance because it results in a lower value of ℓ^2 as in Table 2.

5. Sharing system with guard band

In some application, where the transmitted signal faces a badly scattering channel, or in systems that need very high signal to noise ratio, receiver simplicity is not a place of concern. In these systems, one can accept some processing in the receiver in order to increase the performance of the system. A sharing strategy between the transmitter and the receiver for the downlink of the communication system in band-limited ISI channels has been developed. The sharing is such that some equalization is done at the transmitter, while the rest of the process is done at the receiver. This results in an enhancement in comparison with the precoding system, where all the equalization process is done at the transmitter and leaves the receiver quite simple. Also, as in the precoding case, it is assumed that the transmitter has prior knowledge of the channel impulse response.

5.1 System model of the sharing system with guard band

Figure 12 shows the basic model of the sharing system considered. The Transmitter of the system will no differ from the precoding system described in Section 4. The difference

between the two models can be seen obviously in the receiver. The receiver buffer store chooses the central m component of the vector \mathbf{V} to form the vector \mathbf{R} , which will be fed to the receiver's processor matrix \mathbf{F}_2 . This block is new, it was not mentioned in the precoding system, and this is the main difference between the two systems.

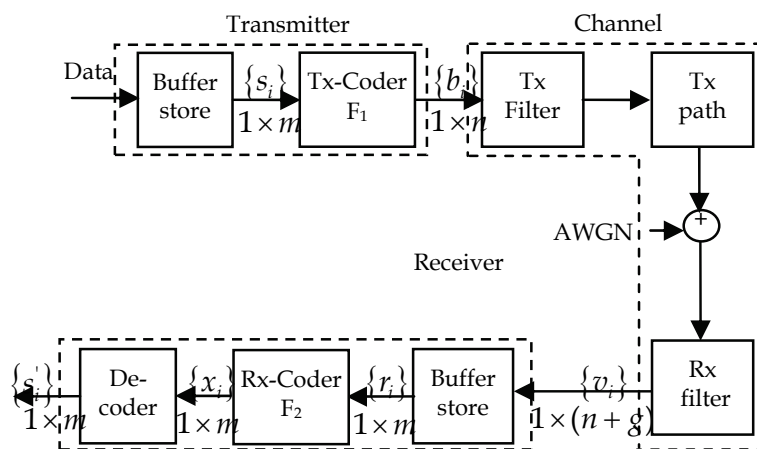

Fig. 12. Basic model of the sharing system with guard band

In the sharing process, the transmitter's processor operates as a precoding scheme on the transmitted signal, and the receiver's processor completes the detection process on the received vector to obtain the detected value of \mathbf{S} . In each case, it has an exact prior knowledge of the channel characteristics \mathbf{Y} , derived from the knowledge of the sampled impulse response of the channel. In the case of a time-varying channel, the rate of change in \mathbf{Y} is assumed to be negligible over the duration of a received group of m signal elements, and sufficiently slow to enable \mathbf{Y} to be correctly estimated from the received data signal.

5.2 Design and analysis of the sharing system with guard band

The main goal from this system is to present a system with better performance than the precoding system. The channel characteristics have no effect on the behavior of the precoding system. The only effected element is the AWGN as shown in Eq. 28. So, let us look on the variance distribution of the precoding system to see how it could be improved. The variance at the output of the system is shown in Fig. 13 and given in the Eq. 29 In order to reduce the power of the noise at the output of the system, η_r^2 should be reduced.

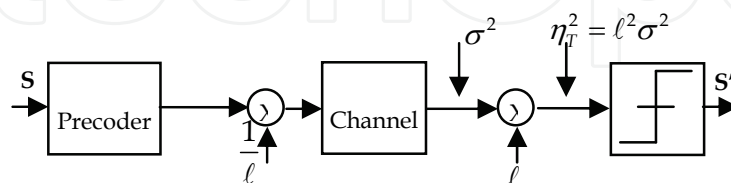

Fig. 13. Variance distribution in the precoding system

The main idea proposed here is to split the precoding process given in Section 4 between the transmitter and the receiver. The full precoder is given in Eq. 25. Here, the full precoder equation should be divided between the transmitter and the receiver by taking part of the $(\cdot)^{-1}$ to the receiver, so that the transmitter's share of the process is the $m \times n$ matrix:

$$\mathbf{F}_1 = (\mathbf{D}\mathbf{D}^T)^{-p} \mathbf{D} \quad (31)$$

where:

$$0 \leq p \leq 1 \quad (32)$$

and the receiver's share of the process is the $m \times m$ matrix:

$$\mathbf{F}_2 = (\mathbf{D}\mathbf{D}^T)^{-q} \quad (33)$$

where:

$$q = p - 1 \quad (34)$$

So, the total equation of the system from the input to the output is:

$$\mathbf{X} = \mathbf{S}\mathbf{F}_1\mathbf{C}\mathbf{F}_2 = \mathbf{S} \quad (35)$$

As mentioned earlier, the assumption that $\mathbf{C} = \mathbf{D}^T$ is because that only the central m components of the vector \mathbf{V} , i.e., $[v_{g+1} \ v_{g+2} \ \dots \ v_{g+m}]$, will be taken into consideration because they give information about the transmitted data without ISI.

In absence of AWGN, it is clear from the Eq. 36 above that there is no need for any further processing after the receiver's share of the equalization process, but when noise is present,

$$\mathbf{X} = (\mathbf{S}\mathbf{F}_1\mathbf{C} + \mathbf{W})\mathbf{F}_2 = \mathbf{S} + \tilde{\mathbf{W}} \quad (36)$$

The variance distribution of the sharing system is shown in Fig. 14. The effect of this change in the variance distribution through the system block diagram will be explained later in the next subsection.

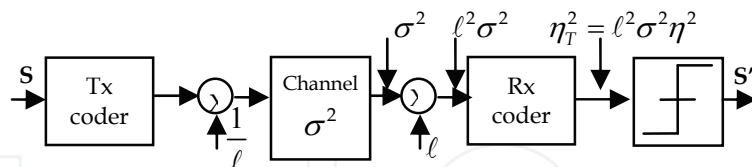

Fig. 14. Variance distribution in the sharing system with guard band

5.3 Performance evaluation of the sharing system with guard band

Using the same assumptions as in the precoding system, the tolerance to noise of the transmitter's share is the same as the precoding system, and is determined by $\ell^2\sigma^2$.

In the receiver, it is clear that the tolerance to noise can be calculated by:

$$\eta^2 = \frac{1}{m} \sum_{j=1}^m \sum_{i=1}^m (f_2)_{ij}^2 \quad (37)$$

and, the total tolerance to noise from both the transmitter's and the receiver's shares is

$$\eta_T = \sqrt{\ell^2\eta^2\sigma^2} = \ell\eta\sigma \quad (38)$$

In case of no distortion, the signal to noise ratio (SNR)_{ND} is given by:

$$SNR_{ND} = \frac{\xi_b}{\sigma^2} \quad (39)$$

while the signal to noise ratio in the real channel (with noise) is:

$$SNR_C = \frac{\xi_b}{\eta_T^2} = \frac{\xi_b}{\ell^2 \eta^2 \sigma^2} \quad (40)$$

In order to understand the behavior of the system, the signal to noise ratio relative to no distortion channel is calculated as follows:

$$SNR_{relative} = \frac{SNR_C}{SNR_{ND}} = \frac{1}{\ell^2 \eta^2} \quad (41)$$

or in dB:

$$SNR_{relative} = 10 \log_{10} \left(\frac{1}{\ell^2 \eta^2} \right) \text{ dB} \quad (42)$$

The bit error rate equation may be written as:

$$P_e = \frac{1}{2} \operatorname{erfc} \left[\frac{\sqrt{\xi_b}}{\sqrt{2} \eta_T} \right] = \frac{1}{2} \operatorname{erfc} \left[\frac{1}{\ell \eta} \sqrt{\frac{\xi_b}{N_o}} \right] \quad (43)$$

5.4 Numerical results for sharing system with guard band

The equations of the transmitter coder and the receiver coder are given in Eq. 31 and Eq. 33 respectively. From the mentioned equations, the most effective part is the sharing ratio factors p and q . The relation between p and q is linear, so, the factor p is taken as the main factor to test the system and find the optimum solution that gives the best performance.

Table 3 shows the numerical results of the variables: the energy of the transmitted vector ℓ given in Eq. 26, the effect on noise variance from the receiver share of the equalization process η^2 given in Eq. 37 and the total variance of the vector at the output of the system η_T^2 and its square root η_T given in Eq. 38. All the readings were taken for the channel $\begin{bmatrix} 1 & 2 & 1 \end{bmatrix}$ after being normalized, i.e., $[0.408 \quad 0.816 \quad 0.408]$, with block length $m = 4$ and $m = 8$.

Taking the case for $m = 8$, it is clear from Table 3 that the minimum relative signal to noise ratio is -7.65 dB, which is obtained when the sharing factor p is 0.75, which means that the optimum solution for this system is obtained for $p = 0.75$. So, the coders equations may be finally written as in the following equations:

$$\mathbf{F}_1 = (\mathbf{D}\mathbf{D}^T)^{-0.75} \mathbf{D} \quad (44)$$

$$\mathbf{F}_2 = (\mathbf{D}\mathbf{D}^T)^{-0.25} \quad (45)$$

The value of $SNR_{relative}$ when $p = 1$ (all the process is done in the transmitter and leaves the receiver empty, i.e., precoding system) is -11.58 dB. Comparing those two values of

$\text{SNR}_{\text{relative}}$ shows that the effect of the sharing on the total performance of the system is around 4 dB enhancement for $m = 8$, and 2 dB for $m = 4$.

p	$m = 4$					$m = 8$				
	ℓ	η^2	η_T^2	η_T	SNR _{relative}	ℓ	η^2	η_T^2	η_T	SNR _{relative}
0.00	0.82	59.37	39.58	6.29	-15.98	0.89	1798.70	1438.90	37.93	-31.58
0.10	0.79	34.90	21.74	4.66	-13.37	0.86	699.40	514.71	22.69	-27.12
0.20	0.77	20.66	12.30	3.51	-10.90	0.83	273.63	189.78	13.78	-22.78
0.30	0.77	12.36	7.27	2.70	-8.62	0.82	108.14	73.34	8.56	-18.65
0.40	0.78	7.52	4.57	2.14	-6.60	0.84	43.47	30.56	5.53	-14.85
0.50	0.82	4.69	3.12	1.77	-4.95	0.89	18.00	14.40	3.79	-11.58
0.60	0.89	3.03	2.38	1.54	-3.76	1.02	7.85	8.20	2.86	-9.14
0.70	1.00	2.06	2.06	1.44	-3.14	1.27	3.73	6.05	2.46	-7.82
0.75	1.08	1.74	2.03	1.42	-3.07	1.47	2.70	5.82	2.41	-7.65
0.80	1.17	1.50	2.06	1.44	-3.14	1.73	2.03	6.05	2.46	-7.82
0.90	1.42	1.18	2.38	1.54	-3.76	2.51	1.31	8.20	2.86	-9.14
1.00	1.77	1.00	3.12	1.77	-4.95	3.79	1.00	14.40	3.79	-11.58

Table 3. Numerical results of the sharing system with guard band

In order to give more details about the performance of the system in figures, Fig. 15 (a) shows the effect of the p on the signal to $\text{SNR}_{\text{relative}}$ for $m = 4$. It is clear that the system has the best performance at $p = 0.75$, with about 2 dB gain more than the case where $p = 1$.

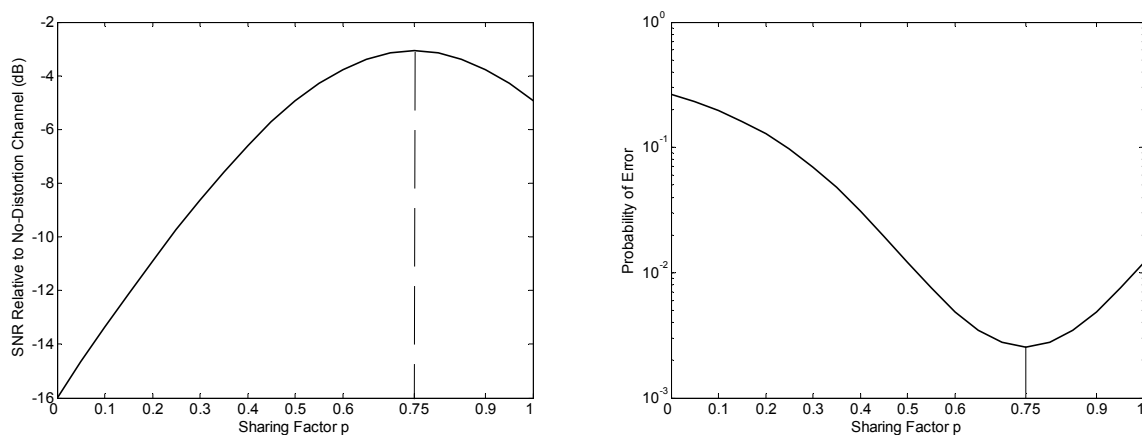

Fig. 15. (a) Effect of sharing factor p on the SNR in the sharing system with guard band, (b) Effect of sharing factor p on the BER in the sharing system with guard band

Then, Fig. 15 (b) shows the effect of bit error rate for all values of p for $m = 4$, also, $p = 0.75$ is the best. In both cases, the channel impulse response was limited to $[0.408 \ 0.816 \ 0.408]$, while the SNR was chosen to be 9 dB. Now, after determining the optimum solution of the system that gives the best performance, the total behavior of the system is observed, in terms of the probability of error for different values of SNR, and to compare that curve with other previously introduced systems such as the precoding system and the BLE.

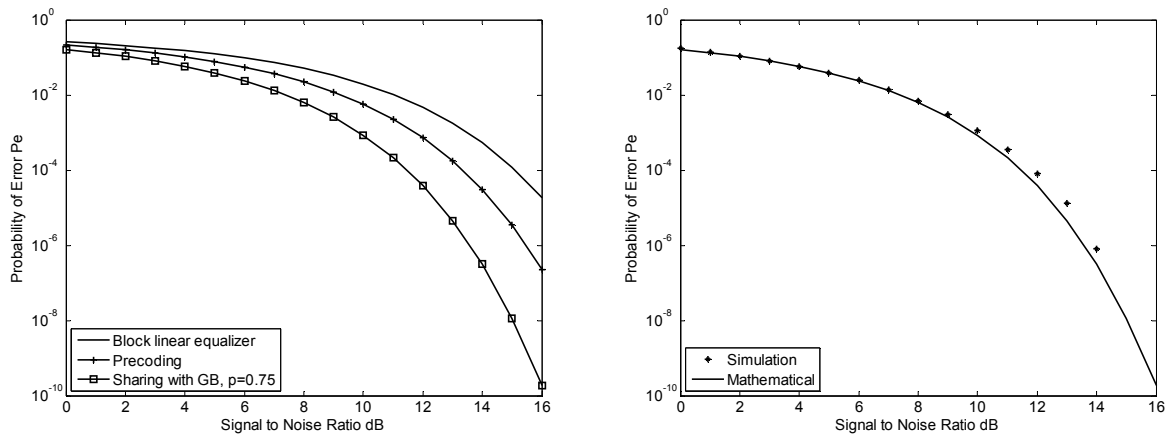

Fig. 16. (a) Probability of error for the sharing system with guard band, (b) Mathematical and simulation results in sharing system with guard band

The BER for this is shown in Fig. 16 (a). It improved the performance with about 2 dB which is a good improvement in badly scattered channels. For the sake of comparison the bit error rate for the block linear equalizer and the precoding system are also given. Figure 20 (b) shows a comparison between the mathematical results, and the output of the Matlab simulation program for $m=4$ and $Y = [0.408 \ 0.816 \ 0.408]$. The results were similar, so, now it is proved that the model presented earlier is correct.

When testing the effect of the block length m on the behavior of the system, and taking into consideration the points discussed while testing this variable for the precoding system, one can easily expect that the performance will become better by reducing the block length, because of the effect of the coders on the variances, and the IBI problem.

Before start testing this variable, the behavior of the most effective elements that almost control everything should be understood. When the effect of the variables on the precoding system is tested, there was one main variable which is the energy of the transmitted code ℓ . This factor (ℓ) depends only on the transmitted energy, and has no relationship with the receiver side, because the receiver was empty there. But here, another complicated element η_T appeared, as given in Eq. 38, and its components: ℓ and η as in Eq. 26 and Eq. 37.

The noise will be affected by both transmitter and receiver. This change may be constructive some times if the value of ℓ or η is less than 1. In case of getting a value of 1 for either ℓ and η , this means that this element is neutral, and will not affect the system. It is also expected, in special cases, that one stage will cancel the effect of the other if the multiplication of ℓ and η is equal to 1. The way that how those variables change by changing the block length will have an important role in performance.

Figure 21 (a) gives an idea about their behavior for $Y = [1 \ 2 \ 1]$. It is clear that all the variables are increasing rapidly by increasing the block length, which means that the performance of the system will be worse for long blocks.

Here, ℓ and η will be stable for very long codes, but the effective variable η_T will continue increasing. So, the behavior of the block length is not expected to take a stable region as in precoding, and will take another shape, but when plotting the BER vs. block length in Fig. 17 (b) for $Y = [1 \ 2 \ 1]$, the behavior is the same (only the performance is better), and this is because of the nonlinearity of the error complementary function used to calculate the BER.

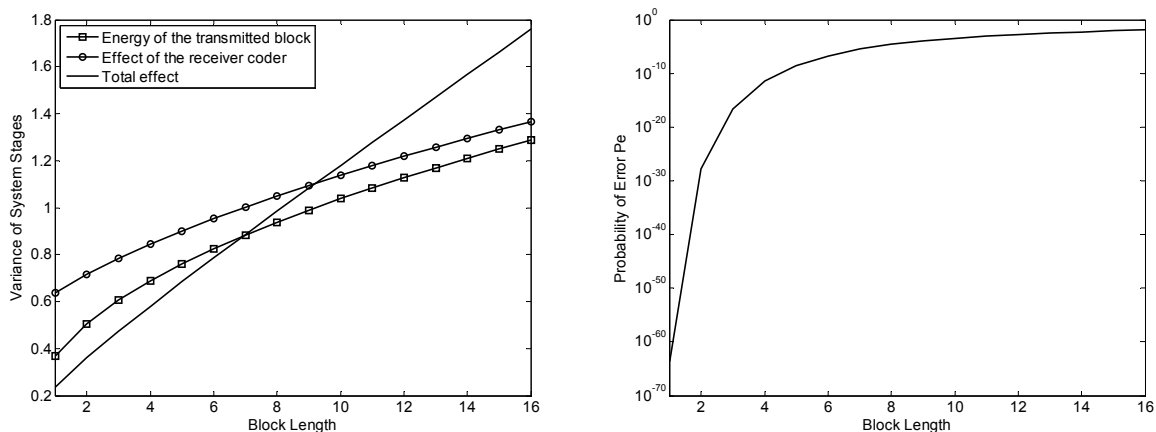

Fig. 17. (a) The behavior of the system variance in sharing system with guard band, (b) Effect of the block length m on the BER in sharing system with guard band

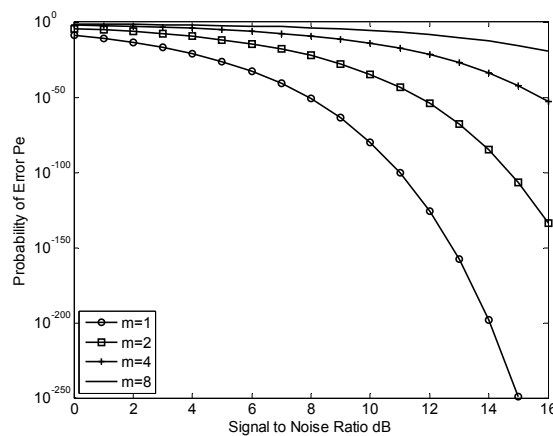

Fig. 18. Effect of block length on sharing system with guard band

Figure 22 shows the BER of the system versus SNR for four block lengths. The channel here is assumed to be $Y = \begin{bmatrix} 1 & 2 & 1 \end{bmatrix}$. It is clear that increasing the block length will reduce the performance of the system rapidly. Now, let us test different channel characteristics to see which channels are suitable for this system, but before doing that, and referring to the effect of the block length results, one can say that it will take the same behavior as the precoding system because it depends mainly on the major players in this system, which are the factors that affect variances of the noise vector, as given in Table 4. Also, the amplitude spectrum of the channel will have an effect too. So, in order to focus only on the variables of the system, channels that have identical amplitude spectrum will be taken in each case of comparison.

In Fig. 19 (a), the effect of the channel length on the performance of the system is studied, for $m = 4$, using two different channels with different lengths: $g = 2$ and $g = 4$, but with the same norm values, as shown in Table 1. The channels used here are: $[0.235 \ 0.667 \ 1 \ 0.667 \ 0.235]$ and $[0.707 \ 1 \ 0.707]$. From Table 4, it is clear that both ℓ^2 and η^2 for the long channel are higher than the short one (in the studied case of $m = 4$) causing and increase in the noise variance. The results show better performance for the channel with less noise (the short one).

Channel vector	$m = 1$		$m = 2$		$m = 4$		$m = 8$	
	ℓ^2	η^2	ℓ^2	η^2	ℓ^2	η^2	ℓ^2	η^2
[0.235 0.667 1 0.667 0.235]	0.14	0.71	0.37	1.10	1.09	2.18	2.20	3.29
[0.707 1 0.707]	0.24	0.71	0.46	0.92	0.84	1.26	1.23	1.53
[0.5 1 -0.5]	0.27	0.82	0.41	0.82	0.55	0.83	0.66	0.83
[0.5 1 0.5]	0.27	0.82	0.51	1.02	0.95	1.42	1.76	2.20
[1 2 1]	0.14	0.41	0.26	0.51	0.47	0.71	0.88	1.10
[0.707 2.234 0.707]	0.14	0.41	0.23	0.46	0.34	0.51	0.44	0.55

Table 4. The effective parameters on the sharing system with guard band

Then, the effect of the channel norm value of the performance of the system is tested, as shown in Fig. 19 (b). Two channels that differ in variance are used, but similar in length, i.e., [0.707 1 0.707] and [1 2 1]. The channel with higher variance (norm) has better performance than the one with lower variance. Again, one look on Table 4 will make it a logic result because [0.707 1 0.707] will face more noise.

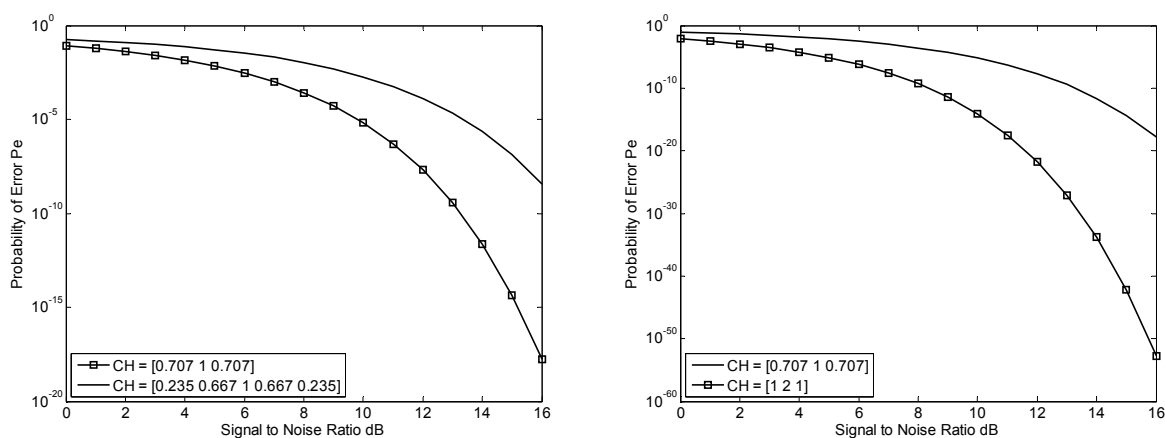

Fig. 19. (a) Effect of channel length on sharing system with guard band, (b) Effect of channel variance on sharing system with guard band

Also, taking any other case from the tested channels will give the same results for any block length, but the case of $m = 4$ is taken to make it easy to compare different figures.

In Fig. 20 (a), typical channels are used, but the sign of one of them is reversed at one side, also, asymmetric channels gave much better performance than symmetric one as expected. Many factors helped the asymmetric channel to have better performance such as the noise level due to the values of ℓ and η given in Table 4, and the great amplitude spectrum as shown in Fig. 3 (f). At last, the effect of amplitude of the impulse response is tested in Fig. 20 (b), Although the length, the symmetry and the norm were typical, but the amplitude affects the values of ℓ and η in a way that helps [0.707 2.234 0.707] to have better performance.

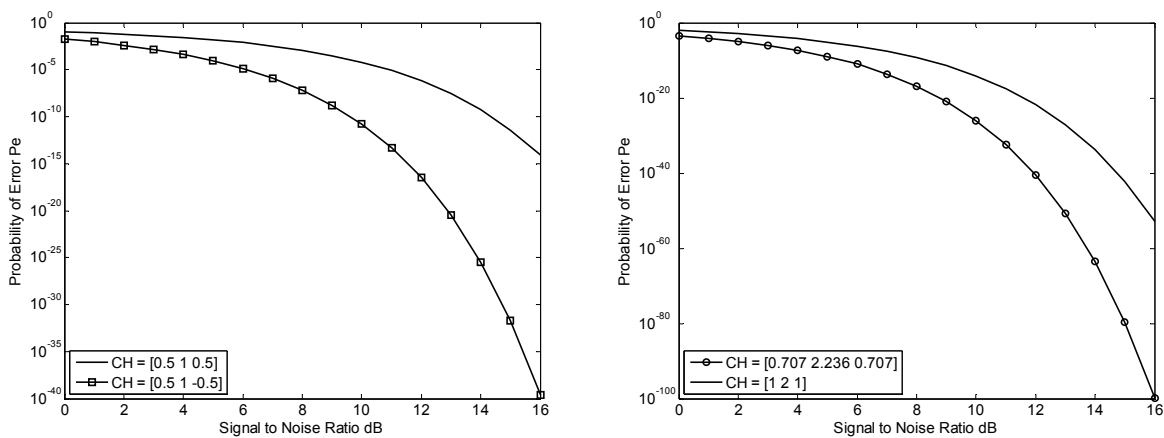

Fig. 20. (a) Effect of channel symmetry on sharing system with guard band, (b) Effect of channel amplitude on sharing system with guard band

6. Sharing system without guard band

The main difference between this system and the sharing system with GB is length of the transmitted vector. Both of them may transmit the same vector at the input of the transmitter, but after coding, the previous system generates a longer code than this one. This will give that system two guard band areas after and before the transmitted block, which will be useful in environments with many obstacles that usually cause duplicate versions of the transmitted signal, and finally cause Inter Symbol Interference (ISI).

Unfortunately, all the advantages can not be available in one system. The immunity against ISI will cause increase in bandwidth in an unaccepted ratios in some applications where the bandwidth is very narrow, or in crowded environments that result in long channel impulse response. For example, transmission in codes of 4 elements in an environment with a baseband channel of length 5 ($g = 4$), will cause a transmitted block of length 12 at the previous system and of length 8 at this one.

So, this system is introduced as a bandwidth efficient system, if the ISI may be accepted in certain ratios.

6.1 System model of the sharing system without guard band

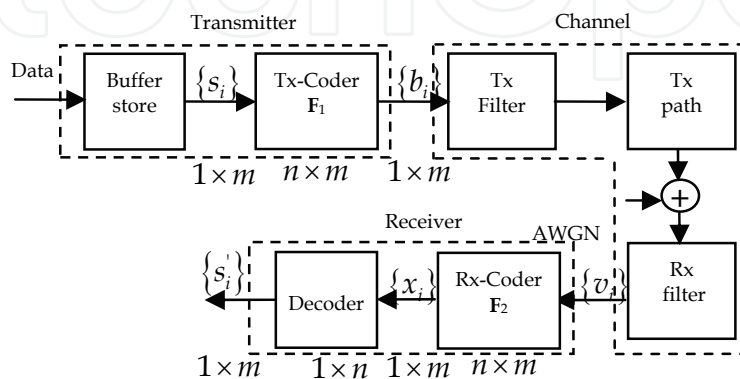

Fig. 21. Basic model of sharing system without guard band

Figure 21 shows the sharing system without guard band considered. The signal at the input to the transmitter will not differ from the two previous systems. Here, the buffer-store at the input to the transmitter holds m successive element values $\{s_i\}$ to form the $1 \times m$ data vector \mathbf{S} . The difference is the size of the transmitter's processor, \mathbf{F}_1 , in this case, it is an $m \times m$ matrix instead of $m \times n$, so, in this processor, \mathbf{S} is converted into the m vector \mathbf{B} . Note that channel vector \mathbf{Y} is arranged in the same manner as done for \mathbf{C} in the previous sections, but here, because the transmitted block contains only m elements instead of n elements, the size of the channel matrix is $m \times n$ instead of $n \times n + g$. The output of the channel is the $1 \times n$ vector \mathbf{V} which will be fed to the receiver's processor \mathbf{F}_2 to complete the detection process on the received vector to obtain the detected value of \mathbf{S} .

6.2 Design and analysis of the sharing system without guard band

As it was done in the sharing system with GB, the equalization process, between the transmitter and the receiver, will be split. Here, the size of the channel output vector is $1 \times n$, and the size of the receiver's coder is $n \times m$, which means that all the vector elements are needed for the coding process. Here, no way to choose only the central components. So, no need to introduce a new matrix to represent the channel in the coders design. The transmitter's share of the process will be the $m \times m$ matrix:

$$\mathbf{F}_1 = (\mathbf{Y}\mathbf{Y}^T)^{-p} \quad (46)$$

and the receiver's share of the process is the $n \times m$ matrix:

$$\mathbf{F}_2 = \mathbf{Y}^T (\mathbf{Y}\mathbf{Y}^T)^{-q} \quad (47)$$

The rest of the analysis will not differ from the other two systems.

6.3 Performance evaluation of the sharing system without guard band

In order to study the performance of the system, the tolerance to noise, from the transmitter's and the receiver's shares, should be found. Assume that the possible values of \mathbf{S} are equally likely and that the mean square value of \mathbf{S} is equal to the number of bits per element. Suppose that the m vectors $\{\mathbf{Y}_i\}$ have unit length. Since there are m k -level signal elements in a group, the vector \mathbf{S} has k^m possible values each corresponding to a different combination of the m k -level signal-elements. So, the vector \mathbf{B} whose components are the values of the corresponding impulses fed to the baseband channel, has k^m possible values. If e is the total energy of all the k^m values of the input data vector \mathbf{S} , then in order to make the transmitted signal energy per bit is unity, the transmitted signal must be divided by:

$$\ell = \sqrt{\frac{e}{mk^m}} \quad (48)$$

Note here that the difference between this equation and Eq. 26 is the length of the transmitted vector (it was n in Eq. 26). The n sample values which are the components of the vector \mathbf{V}' , must first be multiplied by the factor ℓ to give the m -component vector

$$\mathbf{V} = \ell\mathbf{V}' = \mathbf{B}\mathbf{Y} + \ell\mathbf{W} = \mathbf{S} + \mathbf{U} \quad (49)$$

where \mathbf{U} is an m vector whose components are sample independent Gaussian random variables with zero mean and variance $\ell^2\sigma^2$. Thus, the tolerance to noise of the transmitter's share is determined by the value of $\ell^2\sigma^2$. In the receiver, the tolerance to noise is:

$$\eta^2 = \frac{1}{m} \sum_{j=1}^m \sum_{i=1}^n (f_2)_{ij}^2 \quad (50)$$

So, the total tolerance to noise from both the transmitter's and the receiver's shares is:

$$\eta_T = \sqrt{\ell^2\eta^2\sigma^2} = \ell\eta\sigma \quad (51)$$

The signal to noise ratio, relative to no distortion channel, is:

$$\text{SNR}_{\text{relative}} = 10\log_{10} \left(\frac{1}{\ell^2\eta^2} \right) \text{dB} \quad (52)$$

The bit error rate may be written as:

$$P_e = \frac{1}{2} \operatorname{erfc} \left[\frac{\sqrt{\xi_b}}{\sqrt{2}\eta_T} \right] = \frac{1}{2} \operatorname{erfc} \left[\frac{1}{\ell\eta} \sqrt{\frac{\xi_b}{N_o}} \right] \quad (53)$$

From Eq. 53 above, it is clear that the performance is affected by both the transmitter and receiver share. This came from the effect on the AWGN variance. The effect of the transmitter share comes from the fact that the transmitter equalizer will change the average energy (energy per bit) of the transmitted vector, causing a change in the signal power, so, SNR will be changed.

6.4 Numerical analysis of the sharing system without guard band

From Table 5.4, the minimum $\text{SNR}_{\text{relative}}$ is -8.62 dB, which is obtained when p is 0.25, which means that the best performance will be obtained using the equations below.

$$\mathbf{F}_1 = (\mathbf{Y}\mathbf{Y}^T)^{-0.25} \quad (54)$$

$$\mathbf{F}_2 = \mathbf{Y}^T (\mathbf{Y}\mathbf{Y}^T)^{-0.75} \quad (55)$$

For the case of $m=8$, the value of $\text{SNR}_{\text{relative}}$ when $p=0$ is -12.55 dB, which means that the sharing system without guard band gives 4 dB enhancement in comparison with the block linear equalizer. Referring to Table 3, the best value for the sharing system with guard band was -7.65 dB, so, the system discussed here is not better than the one discussed before. The sharing system with guard band BER is better than this one, but the benefit here is the bandwidth saving because less added bits are used in the transmitted code. It is not strange to discover that the difference between the sharing systems (in performance) is the same as the full systems (the precoding and the block linear equalizer). Each one of the sharing systems have a special case, when removing the sharing by using full (or null)

factor, that returns to the full case. The results in Table 5 were calculated for the normalized channel $Y = [0.408 \ 0.816 \ 0.408]$ and block lengths $m = 4$ and $m = 8$.

p	m = 4					m = 8				
	ℓ	η^2	η_T^2	η_T	SNR relative	ℓ	η^2	η_T^2	η_T	SNR relative
0.00	1.00	4.69	4.69	2.16	-6.71	1.00	18.00	18.00	4.24	-12.55
0.10	1.09	3.03	3.57	1.89	-5.52	1.14	7.85	10.25	3.20	-10.11
0.20	1.22	2.06	3.09	1.76	-4.91	1.42	3.73	7.56	2.75	-8.79
0.25	1.32	1.74	3.04	1.74	-4.83	1.64	2.70	7.27	2.70	-8.62
0.30	1.44	1.50	3.09	1.76	-4.91	1.93	2.03	7.56	2.75	-8.79
0.40	1.74	1.18	3.57	1.89	-5.52	2.80	1.31	10.25	3.20	-10.11
0.50	2.16	1.00	4.69	2.16	-6.71	4.24	1.00	18.00	4.24	-12.55
0.60	2.74	0.91	6.86	2.62	-8.36	6.59	0.88	38.21	6.18	-15.82
0.70	3.52	0.88	10.91	3.30	-10.38	10.40	0.85	91.67	9.57	-19.62
0.80	4.54	0.89	18.46	4.30	-12.66	16.54	0.87	237.22	15.40	-23.75
0.90	5.91	0.93	32.60	5.71	-15.13	26.45	0.92	643.38	25.37	-28.09
1.00	7.71	1.00	59.37	7.71	-17.74	42.41	1.00	1798.70	42.41	-32.55

Table 5. Numerical results of the sharing system without guard band

Fig. 22 (a) shows the effect of p on $\text{SNR}_{\text{relative}}$. It is clear that the best performance is at $p = 0.25$. In Fig. 22 (b), the effect of BER for all values of p is plotted. In both cases, the channel impulse response was limited to $Y = [0.408 \ 0.816 \ 0.408]$, while the SNR was chose to be 9 dB and the block length $m = 4$. The bit error rate for the system described here is shown in Fig. 23 (a) with comparison with other systems discussed through this chapter. Although its performance is not the best of all, but it still better than the block linear equalizer by 2 dB, and, almost, the same as the precoding system. Figure 23 (b) shows a comparison between the mathematical results obtained and the output of the Matlab simulation program for $m = 4$ and $Y = [0.408 \ 0.816 \ 0.408]$. The results were similar.

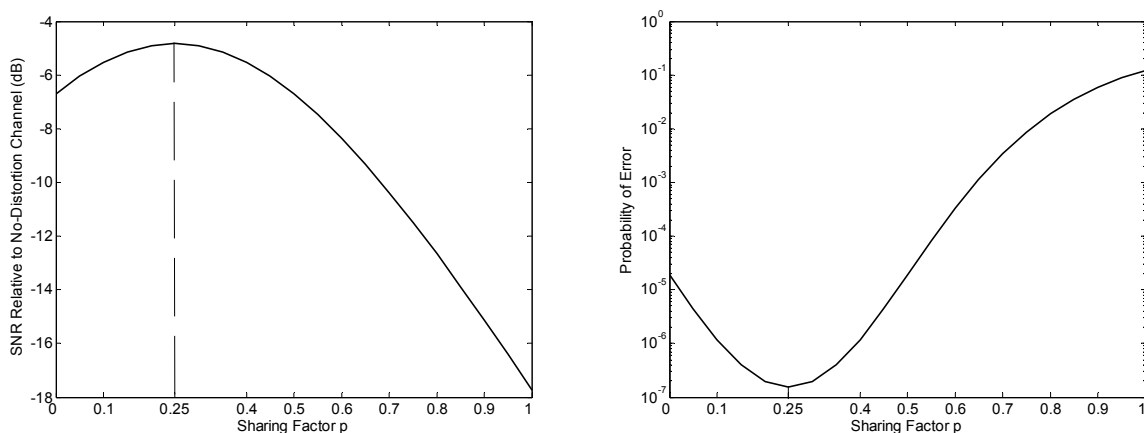

Fig. 22. (a) Effect of the factor p on the SNR in sharing system without guard band, (b) Effect of the factor p on the BER in sharing system without guard band

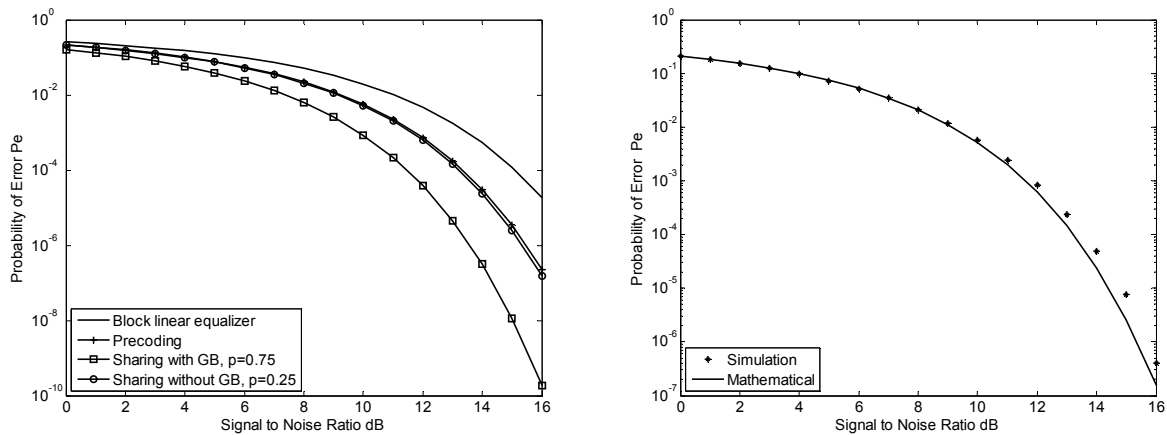

Fig. 23. (a) Probability of error for the sharing system without guard band, (b) Mathematical & simulation results in sharing system without guard band

Figure 24 (a) shows BER of the system for different values of SNR using different block lengths. Increasing the block length will reduce the performance. In Fig. 24 (b), the effect of the channel length on the performance of the system is tested. Here, two different channels are used with different lengths, but with the same norm.

Channel vector	$m = 1$		$m = 2$		$m = 4$		$m = 8$	
	ℓ^2	η^2	ℓ^2	η^2	ℓ^2	η^2	ℓ^2	η^2
[0.235 0.667 1 0.667 0.235]	0.71	0.71	1.10	1.10	2.18	2.18	3.29	3.29
[0.707 1 0.707]	0.71	0.71	0.92	0.92	1.26	1.26	1.53	1.53
[0.5 1 -0.5]	0.82	0.82	0.82	0.82	0.83	0.83	0.83	0.83
[0.5 1 0.5]	0.82	0.82	1.02	1.02	1.42	1.42	2.20	2.20
[1 2 1]	0.41	0.41	0.51	0.51	0.71	0.71	1.10	1.10
[0.707 2.234 0.707]	0.41	0.41	0.46	0.46	0.51	0.51	0.55	0.55

Table 6. The effective parameters on the sharing system without guard band

The short channel, as in the two previously discussed systems, will give better performance because it will face less noise as shown in Table 6.

Then, the effect of the channel norm value of the performance of the system is tested, as shown in Fig. 25 (a). Here, two channels that differ in variance are used, but similar in length. The channels with higher variance (norm) have better performance than those with lower variance.

In Fig. 25 (b), typical channels are the sign of one of them is reversed at one side. The effect was great. Asymmetric channels gave much better performance than symmetric one. It is not strange because the symmetric channel increases the coder variance four times more than the asymmetric one.

The amplitude of the channel has the same effect like the previous two systems because of the values of the energy of the transmitted signal and the effect of the receiver share given in Table 6. Fig. 26 is an example.

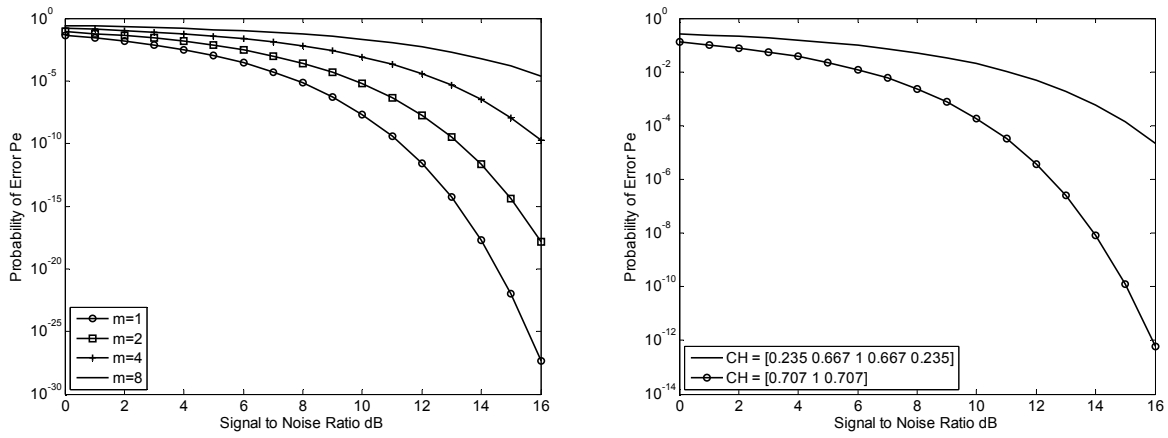

Fig. 24. (a) Effect of block length m on sharing system without guard band,
 (b) Effect of channel length g on sharing system without guard band

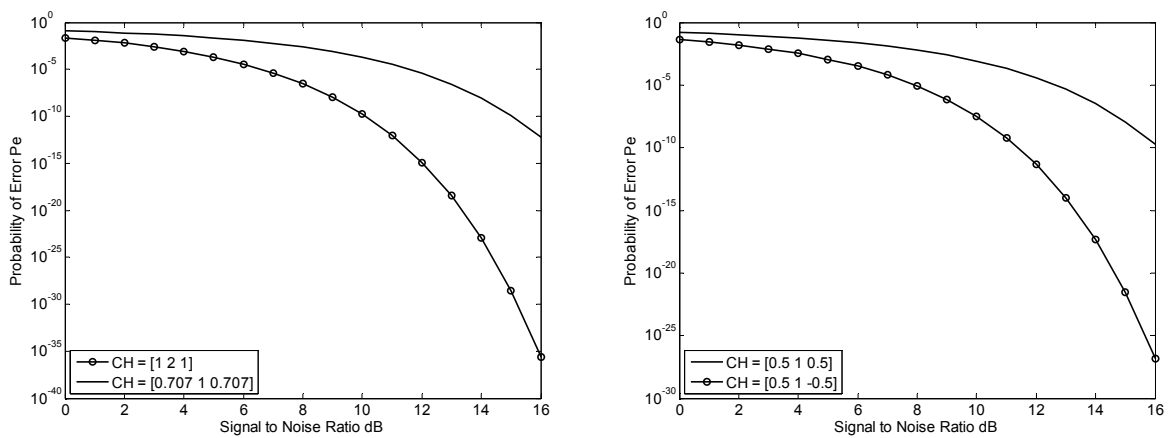

Fig. 25. (a) Effect of channel norm on sharing system without guard band,
 (b) Effect of channel symmetry on sharing system without GB

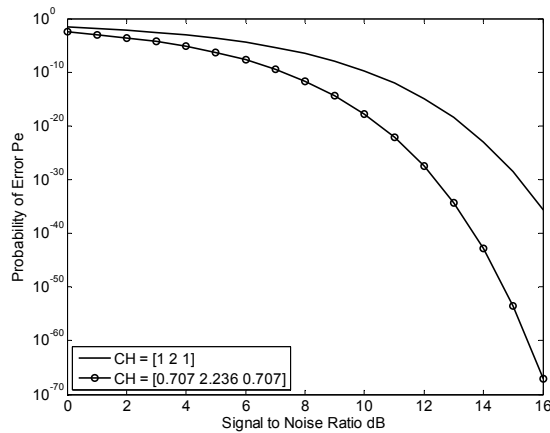

Fig. 26. Effect of channel amplitude on sharing system without GB

7. Conclusion

Here, the three proposed systems in this chapter will be summarized, taking the block linear equalizer as a reference, and all the systems have been evaluated based on a transmitted data block of length $m=4$ and $m=8$ in a channel with $Y=[0.408 \ 0.816 \ 0.408]$. The information given in this comparison may vary when changing the channel, but it will stay relatively constant.

Table 7 shows a comparison between the systems. From the point-view of the bit error rate at $m=4$, the block linear equalizer (BLE) is taken as a reference system with 0 dB improvement. The precoding system gives improvement for about 1.75 dB in comparison with the BLE, while the sharing system results in 1.9 dB enhancement more than the precoding one (3.65 dB more than the BLE). The sharing system without GB was worse than the one with GB, but it still better than the BLE by 1.9 dB and almost the same as the precoding (0.15 dB enhancement).

	Block linear equalizer	Precoding system	Sharing with GB	Sharing without GB
BER ($m=4$)	0 dB (reference)	1.75 dB	3.65 dB	1.9 dB
BER ($m=8$)	0 dB (reference)	1 dB	4.9 dB	4 dB
extra bits (GB)	g	$2g$	$2g$	g
ISI immunity	No	Yes	Yes	No
Transmitter Processing	0%	100%	75%	25%
Receiver Processing	100%	0%	25%	75%

Table 7. Comparison between the systems

Now, from the point-view of the extra bits in the transmitted vector, the BLE will use n bits for each m data signal ($n=m+g$, where $g+1$ is the channel length), and the same value of n for the sharing system without guard band. While the precoding system and the sharing system with GB are generating $n+g$ vector in order to transmit an m data bits, with increase of g bits.

Those extra used bits are useful from the point-view of immunity toward intersymbol interference. Removing the extra bits at the receiver side will remove the bits that faced the intersymbol interference in the channel. So, it is expected that the precoding system and the sharing system with GB are immune to ISI, while the BLE and the sharing system without GB will face ISI.

Form the point-view of the receiver complexity, all the processing will be done in the receiver in the BLE, while it all will be done in the transmitter in the precoding system, leaving the receiver quite simple. The other two systems will share the processing between the transmitter and the receiver in different ratios.

8. Acknowledgment

Author would like to thank Palestinian Technical University-Khadoorie (PTU-K) for supporting the publication of this chapter.

9. References

- Crozier, S., Falconer, D. & Mahmoud, S. (1992). Reduced Complexity Short-Block Data Detection Techniques for Fading Time-Dispersive Channels. *IEEE Transactions on Vehicular Technology* Vol. 41, No. 3: 255-265.
- Ghani, F. (2003). Block Data Communication System for Fading Time Dispersive Channels. *Proceedings of 4th National Conference on Telecommunication Technology, Malaysia*.
- Ghani, F. (2004). Performance Bounds for Block Transmission System. *Proceedings of 2004 IEEE Asia-Pacific Conference on Circuits and Systems, USA*.
- Hayashi, K. & Sakai, H. (2006). Single Carrier Block Transmission without Guard Interval. *Proceedings of 17th Annual IEEE International Symposium on Personal, Indoor and Mobile Radio Communications, Finland*.
- Hsu, F. (1985). Data Directed Estimation Techniques for Single-Tone HF Modems. *Proceedings of IEEE military communication conference, USA*.
- Kaleh, G. (1995). Channel Equalization for Block Transmission Systems. *IEEE Journal on Selected Areas in Communications* Vol. 13, No. 1: 110-121.
- Perl, J., Shpigel, A. & Reichman, A. (1987). Adaptive Receiver for Digital Communication over HF Channels. *IEEE Journal on Selected Areas in Communications* Vol. 5, No. 2: 304-308.
- Proakis, J. (1995). *Digital Communications*. New York, McGraw Hill.
- Varga, R. (1962). *Matrix Iterative Analysis*. Englewood Cliffs, New Jersey, Prentice Hall.

IntechOpen

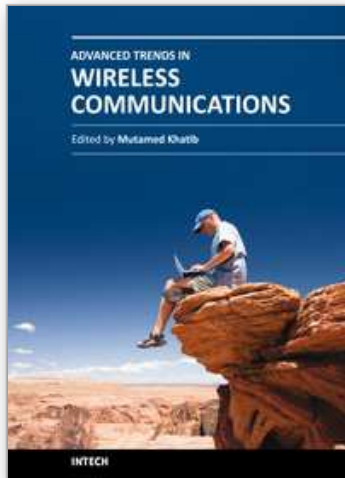

Advanced Trends in Wireless Communications

Edited by Dr. Mutamed Khatib

ISBN 978-953-307-183-1

Hard cover, 520 pages

Publisher InTech

Published online 17, February, 2011

Published in print edition February, 2011

Physical limitations on wireless communication channels impose huge challenges to reliable communication. Bandwidth limitations, propagation loss, noise and interference make the wireless channel a narrow pipe that does not readily accommodate rapid flow of data. Thus, researches aim to design systems that are suitable to operate in such channels, in order to have high performance quality of service. Also, the mobility of the communication systems requires further investigations to reduce the complexity and the power consumption of the receiver. This book aims to provide highlights of the current research in the field of wireless communications. The subjects discussed are very valuable to communication researchers rather than researchers in the wireless related areas. The book chapters cover a wide range of wireless communication topics.

How to reference

In order to correctly reference this scholarly work, feel free to copy and paste the following:

Mutamed Khatib (2011). Block Transmission Systems in Wireless Communications, Advanced Trends in Wireless Communications, Dr. Mutamed Khatib (Ed.), ISBN: 978-953-307-183-1, InTech, Available from: <http://www.intechopen.com/books/advanced-trends-in-wireless-communications/block-transmission-systems-in-wireless-communications>

INTECH
open science | open minds

InTech Europe

University Campus STeP Ri
Slavka Krautzeka 83/A
51000 Rijeka, Croatia
Phone: +385 (51) 770 447
Fax: +385 (51) 686 166
www.intechopen.com

InTech China

Unit 405, Office Block, Hotel Equatorial Shanghai
No.65, Yan An Road (West), Shanghai, 200040, China
中国上海市延安西路65号上海国际贵都大饭店办公楼405单元
Phone: +86-21-62489820
Fax: +86-21-62489821

© 2011 The Author(s). Licensee IntechOpen. This chapter is distributed under the terms of the [Creative Commons Attribution-NonCommercial-ShareAlike-3.0 License](#), which permits use, distribution and reproduction for non-commercial purposes, provided the original is properly cited and derivative works building on this content are distributed under the same license.

IntechOpen

IntechOpen