

# We are IntechOpen, the world's leading publisher of Open Access books Built by scientists, for scientists

5,500

Open access books available

136,000

International authors and editors

170M

Downloads

Our authors are among the

154

Countries delivered to

TOP 1%

most cited scientists

12.2%

Contributors from top 500 universities



WEB OF SCIENCE™

Selection of our books indexed in the Book Citation Index  
in Web of Science™ Core Collection (BKCI)

Interested in publishing with us?  
Contact [book.department@intechopen.com](mailto:book.department@intechopen.com)

Numbers displayed above are based on latest data collected.  
For more information visit [www.intechopen.com](http://www.intechopen.com)



# Control of a Double Feed and Double Star Induction Machine Using Direct Torque Control

Leila Benalia

*Department of electrical Engineering  
Batna University, Rue Chahid Med El Hadi boukhlouf  
Algeria*

## 1. Introduction

DTC is an excellent solution for general-purpose induction drives in very wide range. The short sampling time required by the TC schemes makes them suited to a very fast torque and flux controlled drives as well as the simplicity of the control algorithm. DTC is inherently a motion sensor less control method.

## 2. Objective of the work

This chapter describes the control of doubly fed induction machine (DFIM) and the control of doubly star asynchronous machine (DSAM), using direct torque control (DTC).

## 3. Principe du control direct du couple

Direct torque control is based on the flux orientation, using the instantaneous values of voltage vector.

An inverter provides eight voltage vectors, among which two are zeros (Roys & Courtine, 1995), (Carlos et al., 2005). These vectors are chosen from a switching table according to the flux and torque errors as well as the stator flux vector position. In this technique, we don't need the rotor position in order to choose the voltage vector. This particularity defines the DTC as an adapted control technique of ac machines and is inherently a motion sensor less control method (Casdei et al., 2001), (Kouang-kyun et al., 2000).

## 4. Double feed induction machine (DFIM)

In the training of high power as the rolling mill, there is a new and original solution using a double feed induction motor (DFIM). The stator is fed by a fixed network while the rotor by a variable supply which can be either a voltage or current source.

The three phase induction motor with wound rotor is doubly fed when, as well as the stator windings being supplied with three phase power at an angular frequency  $\omega_s$ , the rotor windings are also fed with three phase power at a frequency  $\omega_{rr}$ .

Under synchronous operating conditions, as shown in (Prescott & Alii., 1958), (Pettersson., 2003), the shaft turns at an angular velocity  $\omega_r$ , such that:

$$\omega_r = \omega_s + \omega_{rr}$$

The sign on the right hand side is (+) when the phase sequences of the three phase supplies to the stator and rotor are in opposition and (-) when these supplies have the same phase sequence. The rotational velocity of the shaft,  $\omega_r$ , is expressed in electric radians per second, to normalize the number of poles.

#### 4.1 Double feed induction machine modelling

Using the frequently adopted assumptions, like sinusoid ally distributed air-gap flux density distribution and linear magnetic conditions and considering the stator voltages ( $v_{s\alpha}$ ,  $v_{s\beta}$ ) and rotor voltages ( $v_{r\alpha}$ ,  $v_{r\beta}$ ) as control inputs, the stator flux ( $\Phi_{s\alpha}$ ,  $\Phi_{s\beta}$ ), and the rotor current ( $i_{r\alpha}$ ,  $i_{r\beta}$ ) as state variables. In the referential axis fixed in relation to the stator, the following electrical equations are deduced:

$$\begin{bmatrix} V_{s\alpha} \\ V_{s\beta} \end{bmatrix} = \begin{bmatrix} R_s & 0 \\ 0 & R_s \end{bmatrix} \begin{bmatrix} I_{s\alpha} \\ I_{s\beta} \end{bmatrix} + \frac{d}{dt} \begin{bmatrix} \Phi_{s\alpha} \\ \Phi_{s\beta} \end{bmatrix} \quad (1)$$

$$\begin{bmatrix} V_{r\alpha} \\ V_{r\beta} \end{bmatrix} = \begin{bmatrix} R_r & 0 \\ 0 & R_r \end{bmatrix} \begin{bmatrix} I_{r\alpha} \\ I_{r\beta} \end{bmatrix} + \frac{d}{dt} \begin{bmatrix} \Phi_{r\alpha} \\ \Phi_{r\beta} \end{bmatrix} + \begin{bmatrix} 0 & \omega \\ -\omega & 0 \end{bmatrix} \begin{bmatrix} \Phi_{r\alpha} \\ \Phi_{r\beta} \end{bmatrix} \quad (2)$$

Expressions of fluxes are given by:

$$\begin{cases} \Phi_{s\alpha} = l_s I_{s\alpha} + M I_{r\alpha} \\ \Phi_{s\beta} = l_s I_{s\beta} + M I_{r\beta} \\ \Phi_{r\alpha} = l_r I_{r\alpha} + M I_{s\alpha} \\ \Phi_{r\beta} = l_r I_{r\beta} + M I_{s\beta} \end{cases} \quad (3)$$

The mathematical model is written as a set of equations of state, both for the electrical and mechanical parts:

$$\frac{dX}{dt} = \dot{X} = AX + BU \quad (4)$$

Where:

$$X = \begin{bmatrix} I_{r\alpha} \\ I_{r\beta} \\ \Phi_{s\alpha} \\ \Phi_{s\beta} \end{bmatrix} \quad \text{and} \quad U = \begin{bmatrix} V_{s\alpha} \\ V_{s\beta} \\ V_{r\alpha} \\ V_{r\beta} \end{bmatrix} \quad (5)$$

The matrices A and B are given by:

$$A = \begin{bmatrix} -\frac{1}{T_s \delta} & \omega_r & \frac{1-\delta}{\delta M T_s} & \frac{1-\delta}{\delta M} \omega_r \\ -\omega_r & -\frac{1}{T_s \delta} & -\frac{1-\delta}{\delta M} \omega_r & \frac{1-\delta}{\delta M T_s} \\ \frac{M}{T_s} & 0 & -\frac{1}{T_s} & 0 \\ 0 & \frac{M}{T_s} & 0 & -\frac{1}{T_s} \end{bmatrix} \quad (6)$$

$$B = \begin{bmatrix} -\frac{1-\delta}{\delta M} & 0 & \frac{1}{L_r \delta} & 0 \\ 0 & -\frac{1-\delta}{\delta M} & 0 & \frac{1}{L_r \delta} \\ 1 & 0 & 0 & 0 \\ 0 & 1 & 0 & 0 \end{bmatrix} \quad (7)$$

$$J \frac{d\Omega}{dt} = C_{em} - C_r - K_f \Omega. \quad (8)$$

Where  $J$  is the moment of inertia of the revolving parts,  $K_f$  is the coefficient of viscous friction, arising from the bearings and the air flowing over the motor, and  $C_r$  is the load couple.

The equation of the electromagnetic torque is:

$$C_e = \frac{3pM}{2L_s} (\Phi_{s\alpha} I_{r\beta} - \Phi_{s\beta} I_{r\alpha}) \quad (9)$$

The block diagram for the direct torque and flux control applied to the double feed induction motor is shown in figure 1. The stator flux  $\Psi_{ref}$  and the torque  $C_{emref}$  magnitudes are compared with respective estimated values and errors are processed through hysteresis-band controllers.

Stator flux controller imposes the time duration of the active voltage vectors, which move the stator flux along the reference trajectory, and torque controller determinates the time duration of the zero voltage vectors, which keep the motor torque in the defined-by hysteresis tolerance band (Kouang-kyun et al., 2000), (Xu & Cheng., 1995). Finally, in every sampling time the voltage vector selection block chooses the inverter switching state, which reduces the instantaneous flux and torque errors (Presada et al., 1998).

## 5. Simulation results machine

Figure 2 refer in order, to the variation in magnitude of the following quantities, speed, flux and electromagnetic torque obtained while starting up the induction motor initially under no load then connecting the nominal load. During the starting up with no load the speed reaches rapidly its reference value without overtaking, however when the nominal load is applied a little overtaking is noticed and the command reject the disturbance. The excellent dynamic performance of torque and flux control is evident.

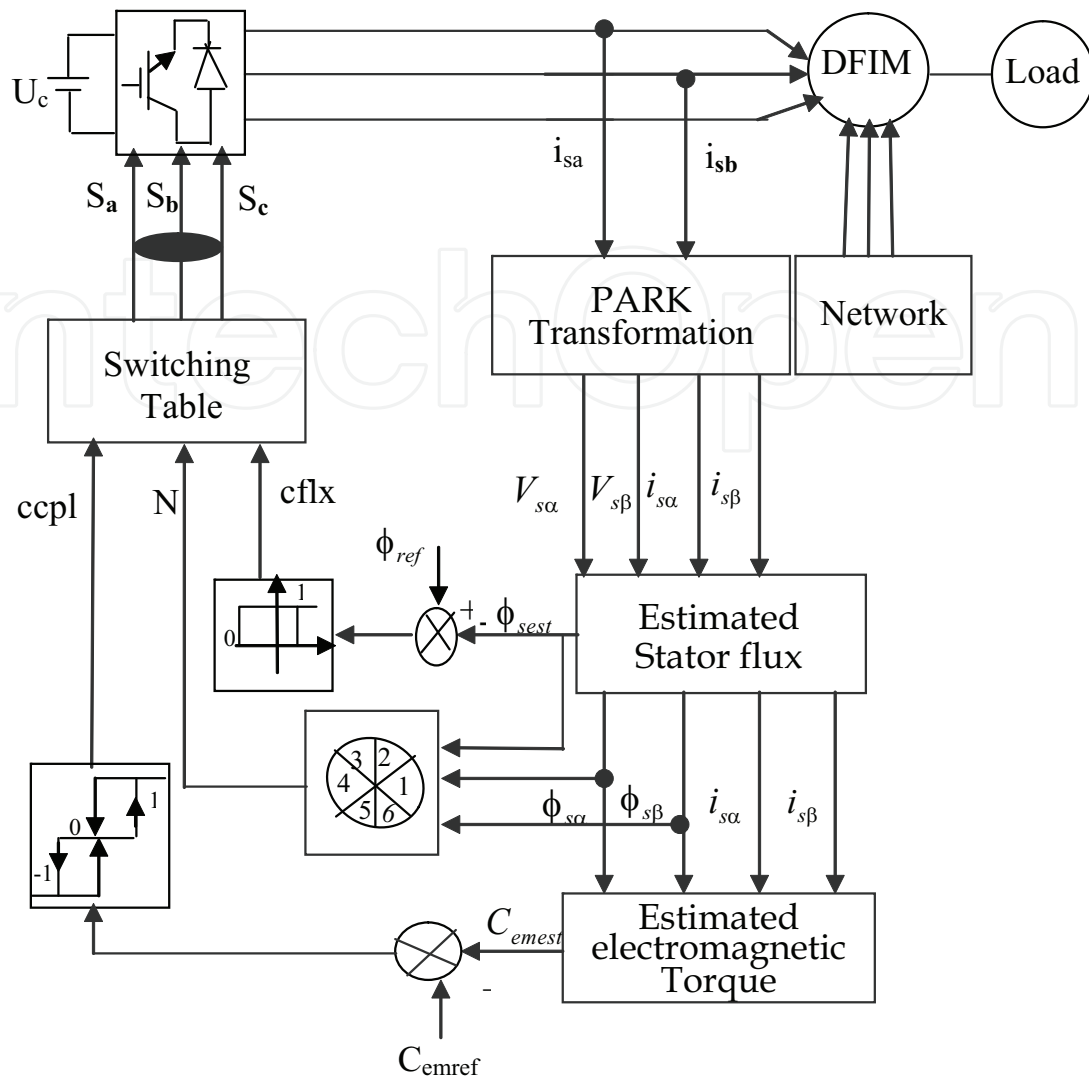

Fig. 1. DTC applied to double feed induction machine

## 6. Robust control of the IP regulator

### a) Speed variation

Figure 3 shows the simulation results obtained for a speed variation for the values: ( $\Omega_{ref} = 157, 100$  and  $157$  rad/s), with the load of  $3$  N.m applied at  $t = 0.8$ s. This results show that the variation lead to the variation in flux and the torque. The response of the system is positive, the speed follow its reference value while the torque return to its reference value with a little error.

### b) Speed reversal of rated value

The excellent dynamic performance of torque control is evident in figure 4, which shows torque reversal for speed reversal of ( $157, -157$  rad/s), with a load of  $5$  N.m applied at  $t = 1$  s. The speed and torque response follow perfectly their reference values with the same response time. The reversal speed leads to a delay in the speed response, to a peak oscillation the current as well as a fall in the flux magnitude which stabilise at its reference value.

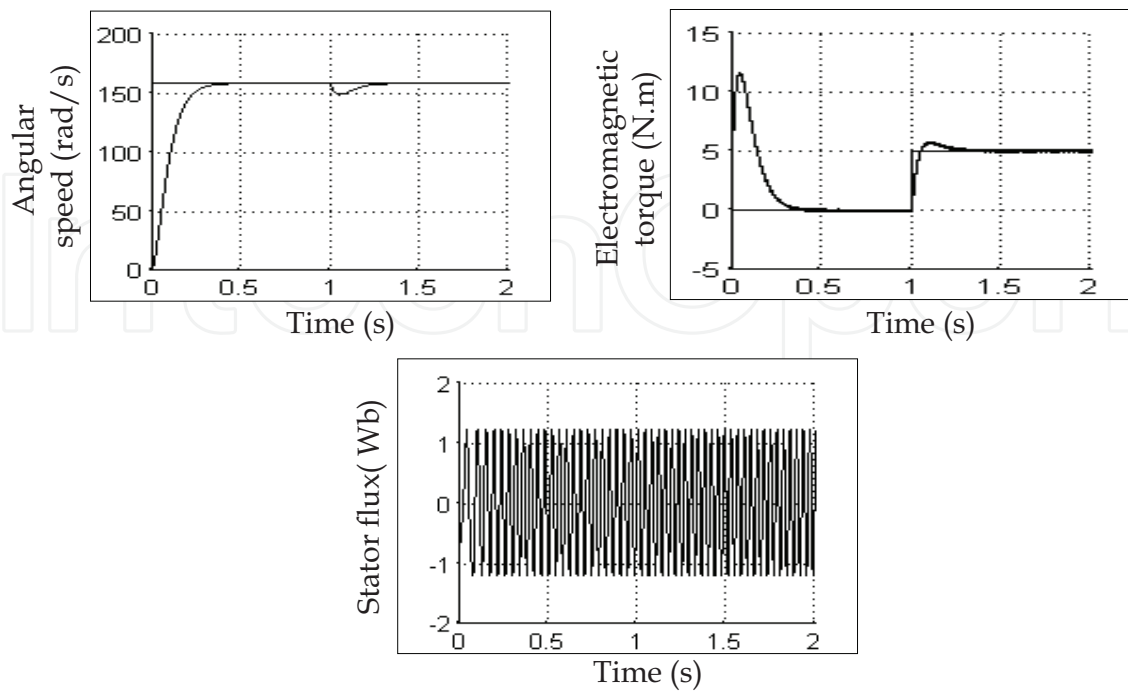

Fig. 2. Simulation results obtained with an IP regulator

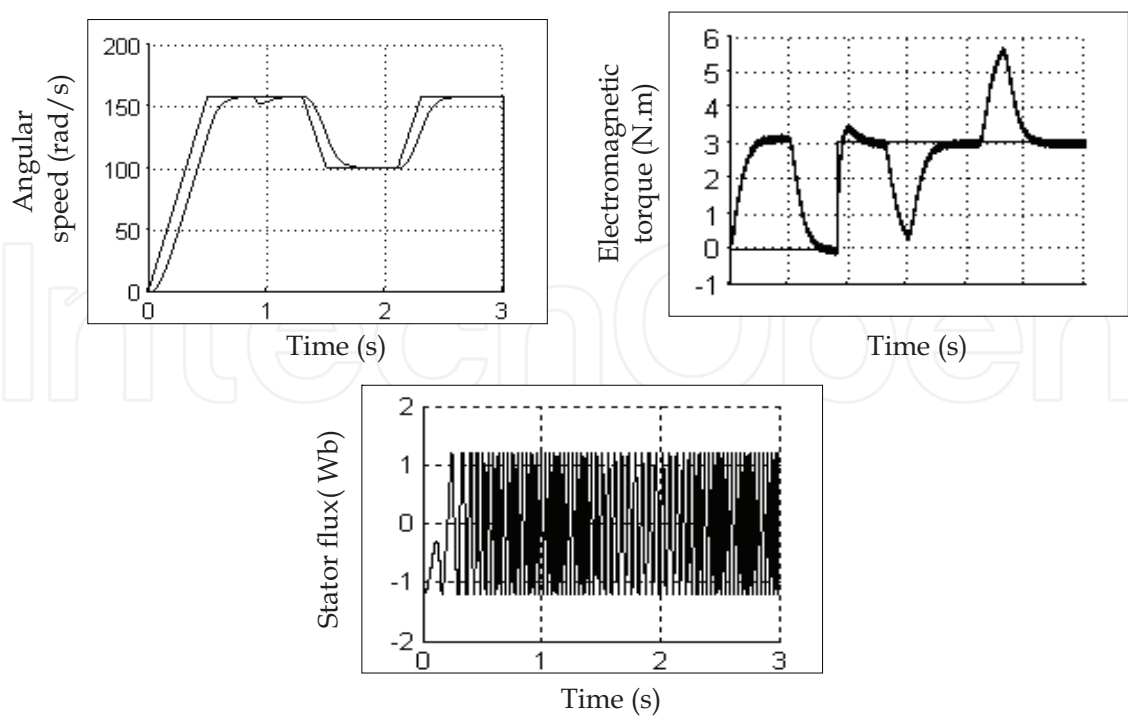

Fig. 3. Robust control for a speed variation

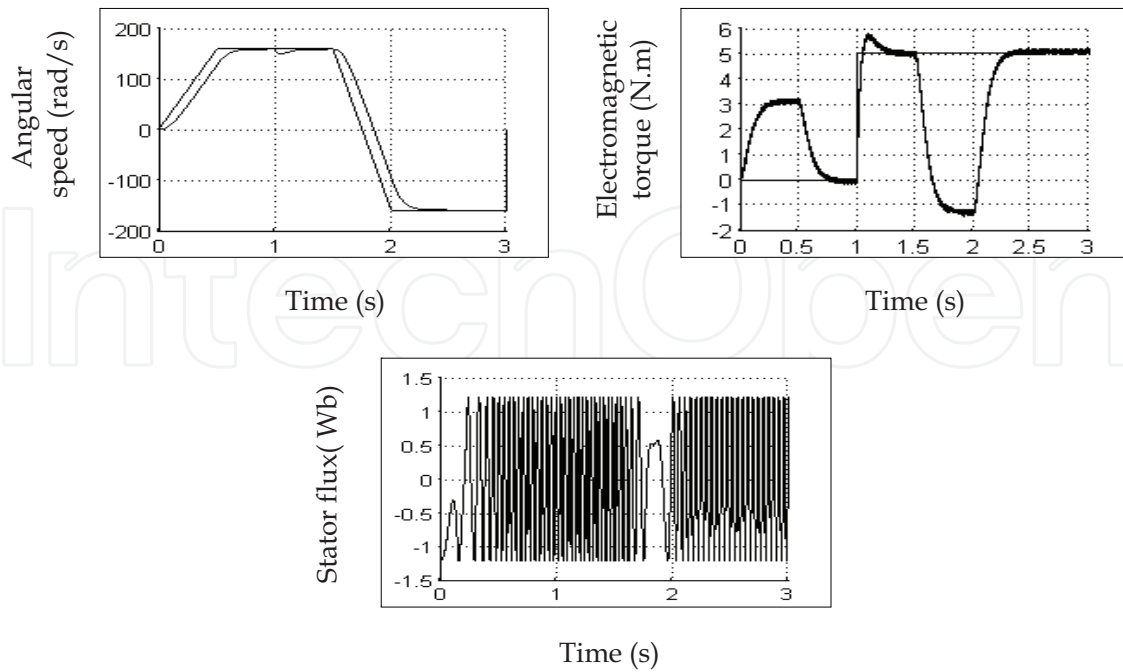

Fig. 4. Robust control under reversal speed

c) Robust control for load variation

The simulation results obtained for a load variation ( $C_r = 3 \text{ N.m}$ ,  $6 \text{ N.m}$ ) in figure 5, show that the speed, the torque and the flux are inflated with this variation. Indeed the torque and the speed follow their reference values.

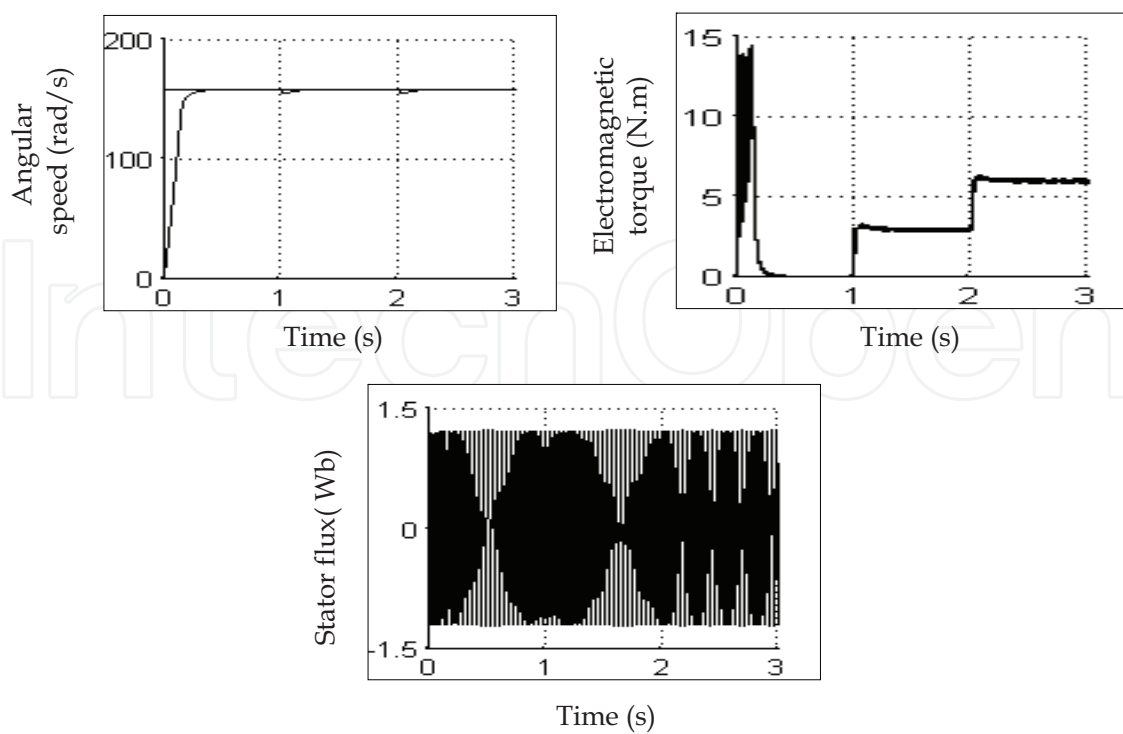

Fig. 5. Robust control under load variation

## d) Robust control of the regulator under stator resistance variation

In order to verify the robustness of the regulator under motor parameters variations we carried out a test for a variation of 50% in the value of stator resistance at time  $t = 1.5$  s. The speed is fixed at 157 rad/s and a resistant torque of 5 N.m is applied at  $t = 1$  s. Figure 6 shows the in order the torque response, the current, the stator flux and the speed. The results indicate that the regulator is very sensitive to the resistance change which results in the influence on the torque and the stator flux.

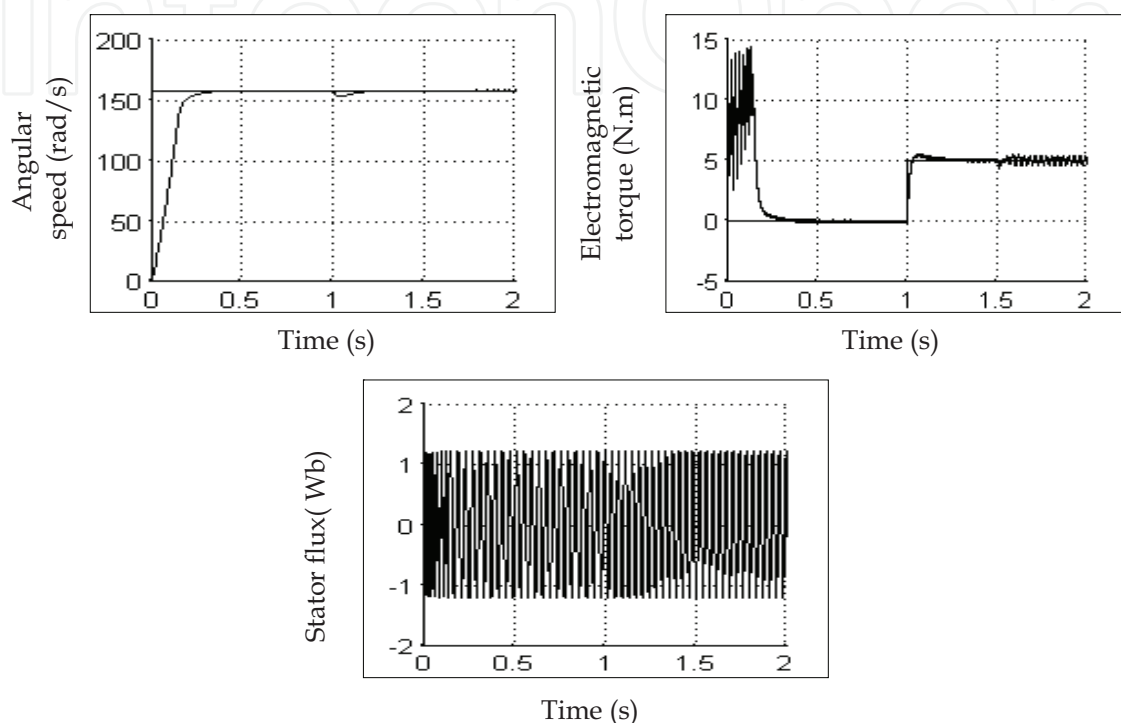

Fig. 6. Robust control under stator resistance variation

## 7. Double star induction machine (DSIM)

For the last 20 years the induction machines with a double star have been used in many applications for their performances in the power fields because of their reduced pulsation when the torque is minimum (Kalantari et al., 2002). The double stator induction machine needs a double three phase supply which has many advantages. It minimises the torque pulsations and uses a power electronics components which allow a higher commutation frequency compared to the simple machines. However the double stator induction machines supplied by a source inverter generate harmonic which results in supplementary losses (Hadiouche et al., 2000). The double star induction machine is not a simple system, because a number of complicated phenomena's appears in its function, as saturation and skin effects (Hadiouche et al., 2000).

The double star induction machine is based on the principle of a double stators displaced by  $\alpha = 30^\circ$  and rotor at the same time. The stators are similar to the stator of a simple induction machine and fed with a 3 phase alternating current and provide a rotating flux.

Each star is composed by three identical windings with their axes spaced by  $2\pi/3$  in the space. Therefore, the orthogonality created between the two oriented fluxes, which must be



strictly observed, leads to generate decoupled control with an optimal torque (Pettersson., 2003).

This is a maintenance free machine.

The machine studied is represented with two stars windings:  $A_{s1}B_{s1}C_{s1}$  et  $A_{s2}B_{s2}C_{s2}$  which are displaced by  $\alpha = 30^\circ$  and the rotoral phases:  $A_r B_r C_r$ .

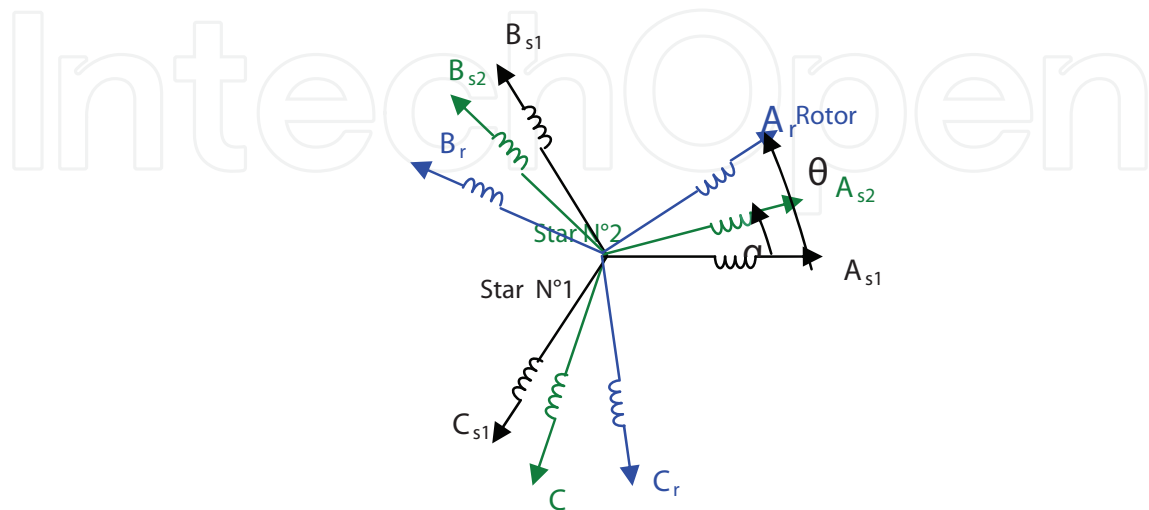

Fig. 7. Double star winding representation

## 8. Double star induction machine modeling

The mathematical model is written as a set of state equations, both for the electrical and mechanical parts:

$$\begin{aligned} [V_{abc,s1}] &= [R_{s1}] [I_{abc,s1}] + \frac{d}{dt} [\Phi_{abc,s1}] \\ [V_{abc,s2}] &= [R_{s2}] [I_{abc,s2}] + \frac{d}{dt} [\Phi_{abc,s2}] \end{aligned} \quad (1)$$

$$\begin{aligned} [V_{abc,r}] &= [R_r] [I_{abc,r}] + \frac{d}{dt} [\Phi_{abc,r}] \\ J \frac{d\Omega}{dt} &= C_{em} - C_r - K_f \Omega \end{aligned} \quad (2)$$

Where:

$J$  is the moment of inertia of the revolving parts.

$K_f$  is the coefficient of viscous friction, arising from the bearings and the air flowing over the motor.

$C_{em}$  is the electromagnetic torque.

The electrical state variables are the flux, transformed into vector  $[\Phi]$  by the "dq" transform, while the input are the "dq" transforms of the voltages, in vector  $[V]$ .

$$\frac{d}{dt} [\Phi] = [A] \cdot [\Phi] + [B] \cdot [v] \quad (3)$$

$$[\Phi] = \begin{bmatrix} \Phi_{ds1} \\ \Phi_{ds2} \\ \Phi_{qs1} \\ \Phi_{qs2} \\ \Phi_{dr} \\ \Phi_{qr} \end{bmatrix} \quad [V] = \begin{bmatrix} v_{ds1} \\ v_{ds2} \\ v_{qs1} \\ v_{qs2} \end{bmatrix} \quad (4)$$

The equation of the electromagnetic torque is given by

$$C_{em} = p \frac{L_m}{L_m + L_r} (\Phi_{dr} (i_{qs1} + i_{qs2}) - \Phi_{qr} (i_{ds1} + i_{ds2})) \quad (5)$$

The flux equation is:

$$\Phi_{md} = L_a \left( \frac{\Phi_{ds1}}{L_{s1}} + \frac{\Phi_{ds2}}{L_{s2}} + \frac{\Phi_{dr}}{L_r} \right) \quad (6)$$

$$\Phi_{mq} = L_a \left( \frac{\Phi_{qs1}}{L_{s1}} + \frac{\Phi_{qs2}}{L_{s2}} + \frac{\Phi_{qr}}{L_r} \right) \quad (7)$$

Given that the "dq" axes are fixed in the synchronous rotating coordinate system, we have:

$$[A] = \begin{bmatrix} a_{11} & a_{12} & a_{13} & a_{14} & a_{15} & a_{16} \\ a_{21} & a_{22} & a_{23} & a_{24} & a_{25} & a_{26} \\ a_{31} & a_{32} & a_{33} & a_{34} & a_{35} & a_{36} \\ a_{41} & a_{42} & a_{43} & a_{44} & a_{45} & a_{46} \\ a_{51} & a_{52} & a_{53} & a_{54} & a_{55} & a_{56} \\ a_{61} & a_{62} & a_{63} & a_{64} & a_{65} & a_{66} \end{bmatrix} \quad (8)$$

$$[B] = \begin{bmatrix} 1 & 0 & 0 & 0 \\ 0 & 1 & 0 & 0 \\ 0 & 0 & 1 & 0 \\ 0 & 0 & 0 & 1 \\ 0 & 0 & 0 & 0 \\ 0 & 0 & 0 & 0 \end{bmatrix} \quad (9)$$

Where:

$$a_{11} = a_{33} = \frac{R_{s1} L_a}{L_{s1}^2} - \frac{R_{s1}}{L_{s1}}$$

$$a_{12} = a_{34} = \frac{R_{s1} L_a}{L_{s1} L_{s2}}$$

$$\begin{aligned} \omega_s a_{13} &= a_{24} = -a_{31} = -a_{42} = \\ a_{14} &= a_{16} = a_{23} = a_{26} = a_{32} = a_{35} = a_{41} = a_{45} = a_{53} = a_{54} = a_{61} = a_{62} = 0 \\ a_{15} &= a_{36} = \frac{R_{s1}L_a}{L_rL_{s1}}, \quad a_{21} = a_{43} = \frac{R_{s2}L_a}{L_{s1}L_{s2}} \\ a_{22} &= a_{44} = \frac{R_{s2}L_a}{L_{s2}^2} - \frac{R_{s1}}{L_{s1}}, \quad a_{25} = a_{46} = \frac{R_{s2}L_a}{L_rL_{s2}} \\ a_{51} &= a_{63} = \frac{R_rL_a}{L_rL_{s1}}, \quad a_{52} = a_{64} = \frac{R_rL_a}{L_rL_{s2}} \\ a_{55} &= a_{66} = \frac{R_rL_a}{L_{r2}^2} - \frac{R_r}{L_r}, \quad a_{56} = -a_{65} = \omega_{gl} \end{aligned}$$

Figure 8 shows the block diagram for the direct torque and flux control applied to the double star induction motor shown in.

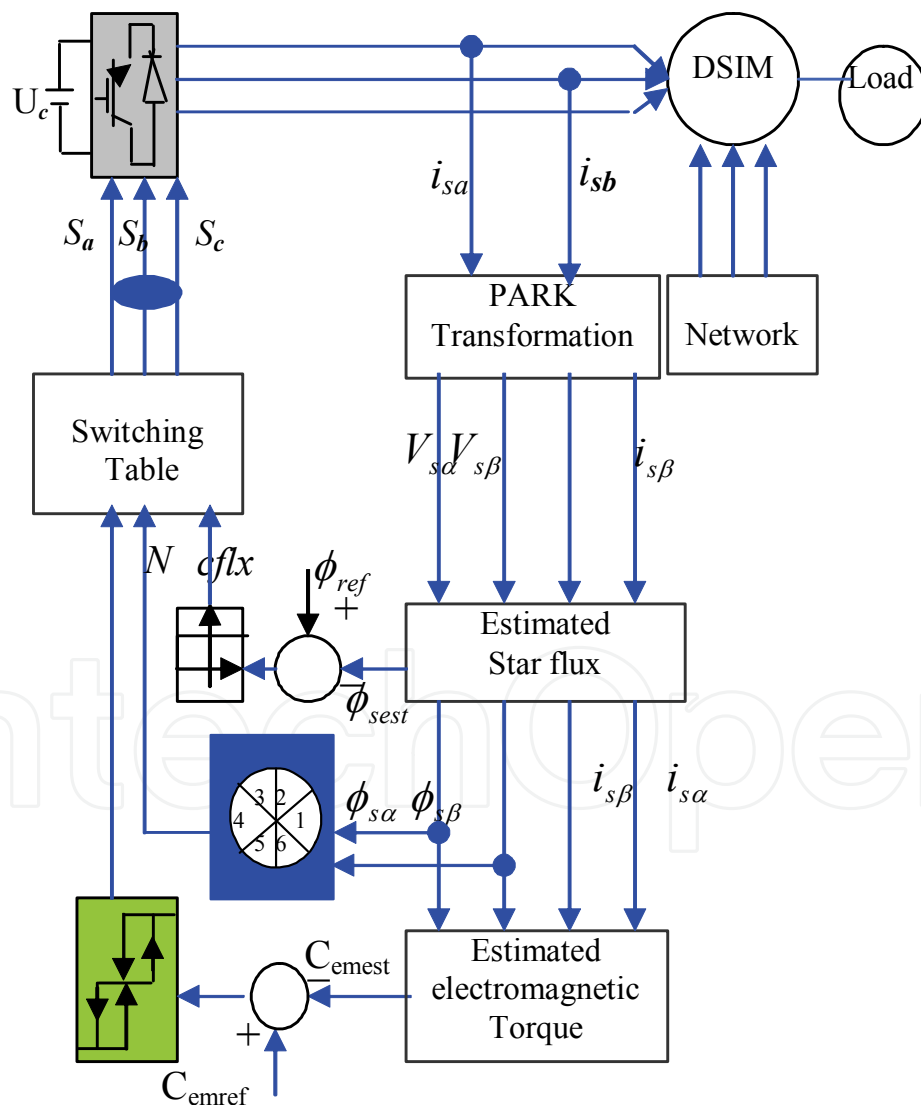

Fig. 8. DTC applied to double star induction machine

## 9. Simulation results

Figure 9 refer in order, to the variation in magnitude of the following quantities, speed, electromagnetic torque, current and flux obtained while starting up the induction motor initially under no load then connecting the nominal load. During the starting up with no load the speed reaches rapidly its reference value without overtaking, however when the nominal load is applied a little overtaking is noticed and the command reject the disturbance. The excellent dynamic performance of torque and flux control is evident.

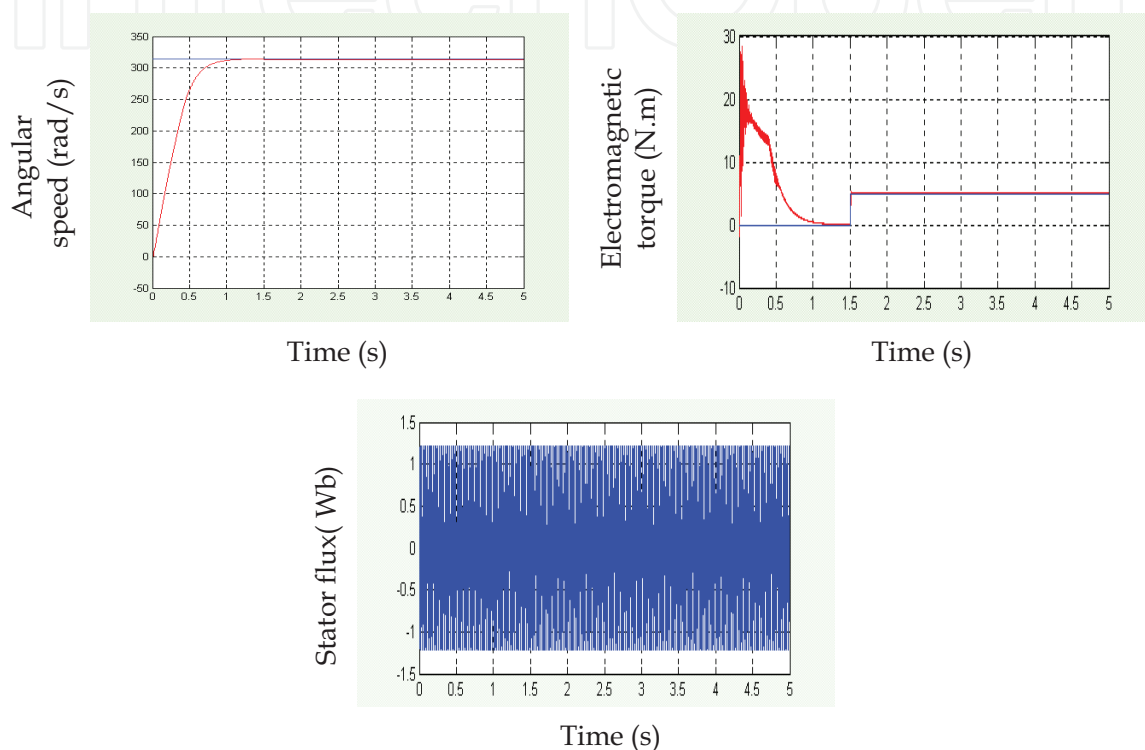

Fig. 9. Simulation results obtained with an PI regulator

## 10. Control of the regulator

### a) Speed variation

Figure.10 shows the simulation results obtained for a speed variation for the values: ( $\Omega_{ref} = 314$  and  $260$  rad/s), with the load of  $5$  N.m applied at  $t=1.5$ s.

These results shows that the variation lead to the variation in flux and the torque. The response of the system is positive, the speed follow its reference value while the torque return to its reference value with a little error.

### b) Robust control for load variation

Figure.11 shows the simulation results obtained for a load variation ( $C_r = 5$  N.m,  $2.5$  N.m). As can be seen the speed, the torque, the flux and current are influenced by this variation. The torque and the speed follow their reference values.

We can see that the control is robust from the point of view load variation.

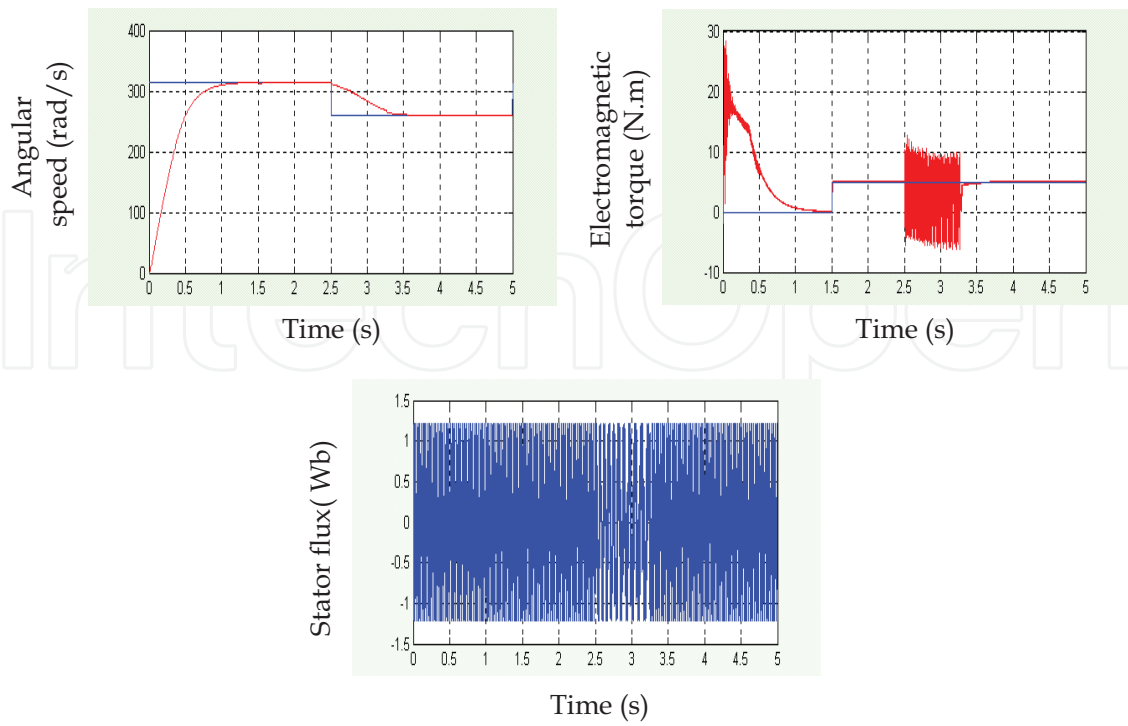

Fig. 10. Robust control for a speed variation

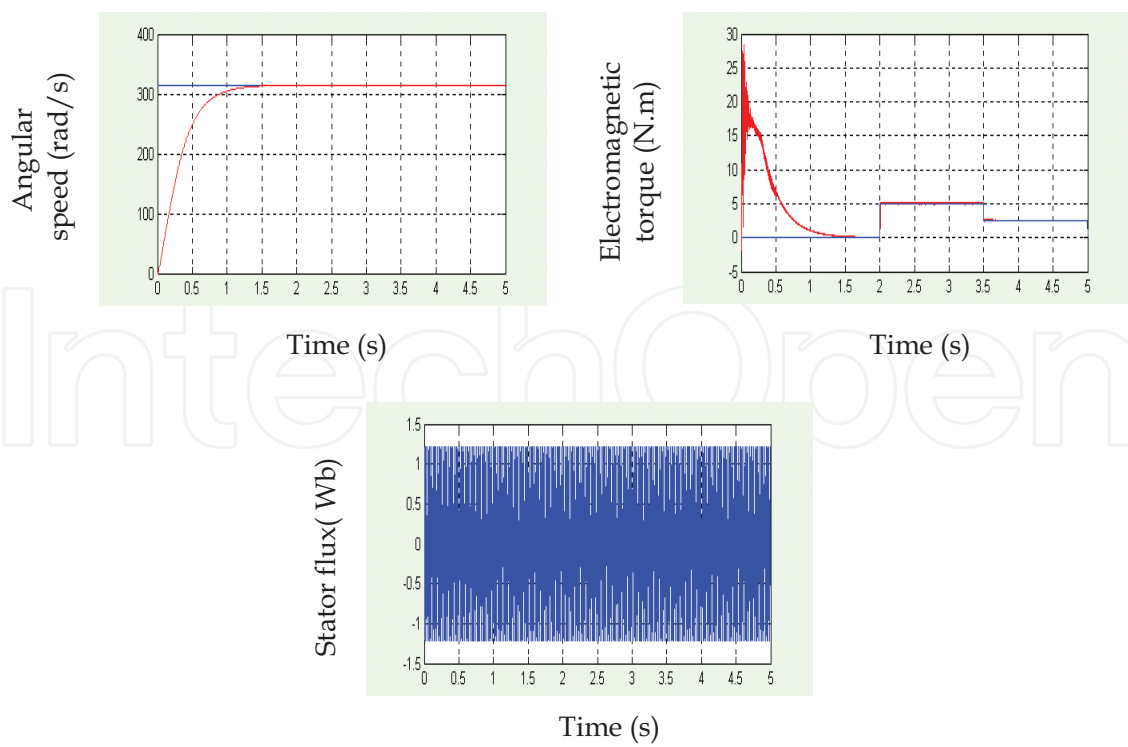

Fig. 11. Robust control under load variation

### c) Robust control of the regulator under star resistance variation

In order to verify the robustness of the regulator under motor parameters variations we carried out a test for a variation of 50% in the value of star resistance at time  $t = 1.5$ s. The speed is fixed at 314 rad/s and a resistant torque of 5N.m is applied at  $t = 1$ s. Figure 6 shows in order the torque response, the current, the stator flux and the speed. The results indicate that the regulator is very sensitive to the resistance change which results in the influence on the torque and the stator flux

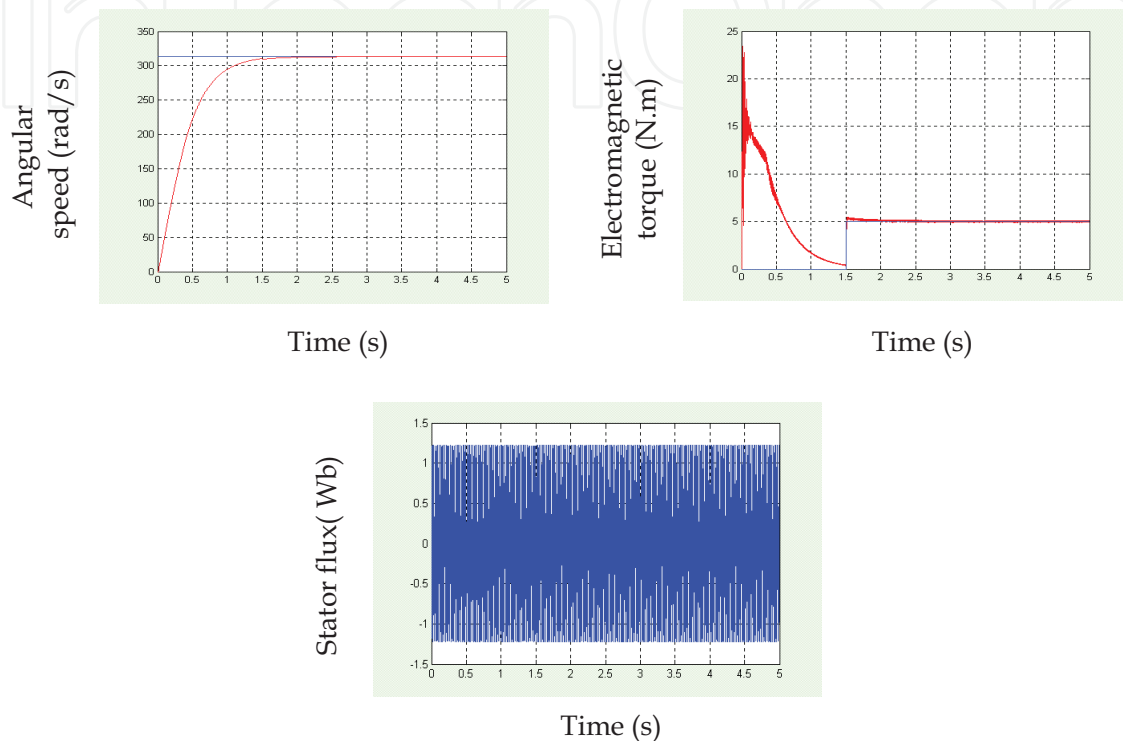

Fig. 12. Robust control under stator resistance variation

## 11. Conclusion

This chapter presents a control strategy for a double feed induction machine and double star induction machine based on the direct control torque (DTC) using a PI regulator. The simulation results show that the DTC is an excellent solution for general-purpose induction drives in a wide range of power.

The main features of DTC compared to the classical flux oriented control FOC can be summarized as follows:

- DTC has a simple and a robust control structure.
- DTC operates with closed torque and flux loops but without current controllers.
- DTC needs stator flux and torque estimation and, therefore, is not sensitive to rotor parameters.
- DTC is inherently a motion sensor less control method.

The simulation results show that the DTC is an excellent solution for general-purpose induction drives in a very wide power range. The short sampling time required by the DTC scheme makes it suited to very fast torque and flux controlled drives beside the simplicity of the control algorithm.

However the DTC presents two major problems:

- The absence of the harmonic of the couple restraint (electromagnetic compatibility, audible noise, variation of the acoustic quality).
- The excitation of some mechanical resonant modes which lead to a serious ageing of the system.

The DTC applies the same control effort to regulate flux as it does for the torque. Finally, we believe that the DTC principle will continue to play a strategic role in the development of high performance motion sensor less AC drives.

## 12. References

- Carlos Ortega, Antoni Arias, Xavier del Toro. (2005). Novel direct torque control for induction motors using short voltage vectors of matrix converters. *IEEE Trans.ind.Appl*, pp 1353- 1358, 2005.
- Casdei.D, Serra.G, Tani.A.( 2001). The use of matrix converters in direct torque control of induction machines. *IEEE Trans.on Industrial Electronics*, Vol 48,N 6,.
- Hadiouche. D, H.Razik, A.Rezzoug.(2000). Study and simulation of space vector PWM control of Double-Star Induction Motors · *IEEE-CIEP*, Acapulco, Mexico, pp 42-47.
- Hadiouche.D, H.Razik, A.Rezzoug.(2000). Modelling of a double-star induction motor with an arbitrary shift angle between its three phase windings. *EPE-PEMC*, Kosice.
- Kalantari.A, M. Mirsalim, H.Rastegar.(2002). Adjustable speed drive based on fuzzy logic for a dual three-phase induction machine. *Electrimacs*, pp 18-21.
- Kouang-kyun La, Myoung-Ho Schin, Dong-Seok Hyun.(2000). Direct torque control of induction motor with reduction of torque ripple. *IEEE Trans.ind.Appl*, pp 1087 -1092
- Petersson.AA, (2003). Analysis, modeling and control of doubly fed induction machine for wind turbines," *tutorials thesis, chalmers university of technology*, Goteborg, Sweden
- Presada.S , E. Chekhet, I Shapoval. (1998). Asymptotic control of torque and unity stator side power factor of the doubly fed induction machine. *Proceedings Intern. Conf" Problems of Electrical Drives*. Alushta, pp 81-86.
- Prescott.JC et Alii.( 1958).The Inherent instability of Induction Motor under conditions of Doubly -Supply. *IEEE Proceedings ,UK*, vol.105,pp 319-330.
- Radwan,.(2005). Perfect speed tracking of directe torque controlled induction motor drive using Fuzzy logic. *IEEE Trans.ind.Appl*, pp 38-43, 2005.
- ROYS et S.COURTINE. ( 1995). Commande directe du couple d'une machine asynchrone par le contrôle direct de son flux statorique. *Journal de Physique III*,pp.863-880.France.
- Xu. L, W. Cheng. (1995). Torque and reactive power control of a doubly fed induction machine by position sensorless scheme. *IEEE Transactions on Industry Applications*, vol 31,no. 3, pp 636-642.

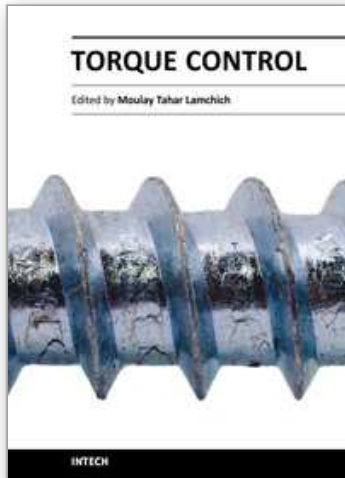

## **Torque Control**

Edited by Prof. Moulay Tahar Lamchich

ISBN 978-953-307-428-3

Hard cover, 292 pages

**Publisher** InTech

**Published online** 10, February, 2011

**Published in print edition** February, 2011

This book is the result of inspirations and contributions from many researchers, a collection of 9 works, which are, in majority, focalised around the Direct Torque Control and may be comprised of three sections: different techniques for the control of asynchronous motors and double feed or double star induction machines, oriented approach of recent developments relating to the control of the Permanent Magnet Synchronous Motors, and special controller design and torque control of switched reluctance machine.

### **How to reference**

In order to correctly reference this scholarly work, feel free to copy and paste the following:

Leila Benalia (2011). Control of a Double Feed and Double Star Induction Machine Using Direct Torque Control, Torque Control, Prof. Moulay Tahar Lamchich (Ed.), ISBN: 978-953-307-428-3, InTech, Available from: <http://www.intechopen.com/books/torque-control/control-of-a-double-feed-and-double-star-induction-machine-using-direct-torque-control>

**INTECH**  
open science | open minds

### **InTech Europe**

University Campus STeP Ri  
Slavka Krautzeka 83/A  
51000 Rijeka, Croatia  
Phone: +385 (51) 770 447  
Fax: +385 (51) 686 166  
[www.intechopen.com](http://www.intechopen.com)

### **InTech China**

Unit 405, Office Block, Hotel Equatorial Shanghai  
No.65, Yan An Road (West), Shanghai, 200040, China  
中国上海市延安西路65号上海国际贵都大饭店办公楼405单元  
Phone: +86-21-62489820  
Fax: +86-21-62489821



© 2011 The Author(s). Licensee IntechOpen. This chapter is distributed under the terms of the [Creative Commons Attribution-NonCommercial-ShareAlike-3.0 License](#), which permits use, distribution and reproduction for non-commercial purposes, provided the original is properly cited and derivative works building on this content are distributed under the same license.

IntechOpen

IntechOpen