

We are IntechOpen, the world's leading publisher of Open Access books Built by scientists, for scientists

5,300

Open access books available

132,000

International authors and editors

160M

Downloads

Our authors are among the

154

Countries delivered to

TOP 1%

most cited scientists

12.2%

Contributors from top 500 universities



WEB OF SCIENCE™

Selection of our books indexed in the Book Citation Index
in Web of Science™ Core Collection (BKCI)

Interested in publishing with us?
Contact book.department@intechopen.com

Numbers displayed above are based on latest data collected.
For more information visit www.intechopen.com



Development of an Open Source GIS Based Decision Support System for Locating Wind Farms in Wallonia (Southern Belgium)

Philippe Lejeune¹, Thibaut Gheysen²,
Quentin Ducenne² and Jacques Rondeux¹

¹*Unit of Forest and Nature Management, Gembloux Agricultural University*

²*Global Forest Care
Belgium*

1. Introduction

Energy policy is central to any country development. It covers not only economic but also social and environmental facets. Choices that have to be made in the scope of energy policy context require appropriate analytical tools and involve participatory processes (Stagl, 2006). Wind energy appears to be one of the most promising renewable resources with a total installed capacity of 120.8 GW at the end of 2008 (GWEC, 2008).

As a signatory of the Kyoto Protocol, Belgium is committed to reducing its GHG emissions by 7.5% between 1990 and 2010. The promotion of "renewable energy sources" is one of the measures for achieving such an objective, especially through the development of wind farms. Walloon authorities, in Southern Belgium, plan to produce 2,250 GWh with onshore wind turbines on the horizon 2020 (Econotec, 2009). This will represent 7.5 % of the region electricity consumption.

However, the development of this so-called "clean" energy has become an increasing source of conflicts. Most opponents complain about the negative visual impacts on landscapes (Gamboa & Munda, 2007; Rodman & Meentemeyer, 2006). Indeed, turbine blades can reach heights of up to 180 m above ground level and can be seen from distance over 20 km. Moreover, this kind of artificial structures is likely to cause significant noise nuisance, electromagnetic interference, disturbance of local wildlife, and others (Sparkes & Kidner, 1996).

The decision-making process regarding the location of wind energy plants is typically multi-faceted. Criteria related to economic, technical, environmental and social factors have to be combined in an appropriate manner (Cavallaro & Ciraolo, 2005). As often suggested, a participatory process involving stakeholders with a more or less important say is central to this decision-making scope (Rauschmayer & Wittmer, 2006). According to recent literature review, multi-criteria decision analysis (MCDA) techniques, and more specifically spatial multi-criteria decision analysis or SMCDA (Zucca et al., 2008), are most appropriate to help decision makers in such a context.

This study was ordered by Walloon authorities who are involved with the appraisal of numerous wind farm projects initiated by private investors. It is two-fold:

Source: Decision Support Systems, Advances in, Book edited by: Ger Devlin,
ISBN 978-953-307-069-8, pp. 342, March 2010, INTECH, Croatia, downloaded from SCIYO.COM

- it aims at mapping constraints relevant to wind farm project appraisal at regional level, and
- it aims at developing an approach meant to identify the most promising sites for wind power production in Wallonia.

In order to reach both objectives, an SDSS has been designed and developed. The methodology that has been adopted as well as some results obtained with this regional decision-making support tool are presented in this paper.

2. Study area

Wallonia is a relatively small region in the southern part of Belgium (figure 1), with an area of about 17.000 km² and a population of approximately 3,500,000 inhabitants; its northern part is densely populated. Under these conditions, any coherent approach to managing wind farm development policy must be supported by a system that can identify and map the potential constraints and suitability, since investments in these projects are mainly driven by individual private operators. These projects are numerous owing to their potential profitability.



Fig. 1. Wallonia is the southern region of Belgium.

3. Methodology

3.1 General methodology

The main steps relevant to the creation of an SMCDAs are outlined hereafter.

- *Identification of Alternatives*

In the context of location of new wind farms, alternatives are defined as the different sites within the study area where wind energy can be developed.

- *Identification and Definition of Criteria*

The identification of criteria implies a systematic analysis of factors that may impact on the wind farms installation (Joerin et al., 2001). This task can be achieved through questionnaires (Baban & Parry, 2001), workshops organized with stakeholders (Stagl, 2006), or based on some expert knowledge or a combination of those (Rodman & Meetemeyer, 2006; Hansen, 2005).

Criteria can be divided in two broad categories (Eastman et al., 1993): constraints and factors. Constraints are generally expressed on a Boolean scale (true/false) and used to limit the next step of the analysis to some part of the study area where constraints are not met (Hansen, 2005). Factors give a continuous measurement of suitability related to certain aspects of the decision-making process. For aggregation purpose, those suitability factors are converted into suitability indexes and subsequently standardized on a continuous [0,1] scale through the use of membership functions (Zadeh, 1965; Chang et al., 2008).

- *Aggregation of Criteria*

Considering the aggregation of criteria, MSCDA can be divided in two groups, i.e. complete versus partial aggregation process. The Weighted Linear Combination method (WLC) is based on the concept of weighted average. It is a very popular method among complete aggregation techniques (Kangas et al., 2008). Methods using partial aggregation processes are called outranking methods among which ELECTRE (Roy, 1991) and PROMETHEE are widely known (Brans et al., 1986).

3.2 Specific methodology

Methodological choices made to develop our SDSS are presented below. They are summarized in the flowchart of the figure 2.

3.2.1 Criteria identification and definition

- *Constraint Criteria*

This main focus of the study is on identifying and defining constraint criteria. They are categorized as either environmental criteria or landscape criteria. Environmental criteria are mainly based on the regional government framework (Ministry for the Walloon Region, 2002), which includes a number of good practices pertaining to wind farm set up. Landscape criteria were defined by a team of researchers who are currently developing a landscape map of the Walloon Region (Feltz et al. 2003). The rationale behind the determination of criteria is given in Feltz et al. (2004). All the criteria were validated in meetings attended by the SDSS designers and the regional planning experts in charge of evaluating wind farm projects.

Twenty-five environmental criteria and fifteen landscape criteria were eventually selected. These 40 criteria are listed in Appendix 1. As explained below, the method proposed in this paper is not constrained by this list of specific criteria, i.e. the method can be easily adapted to different sets of criteria.

- *Suitability Criteria (factors)*

The system component devoted to suitability factors is adaptive and can be run without predefined criteria. All the functionalities have been included in order to create and manage a set of suitability criteria with a high degree of flexibility. Two criteria, the distance between wind farms and high voltage power lines and the distance between wind farms and housing areas have been used to exemplify how flexible the system is.

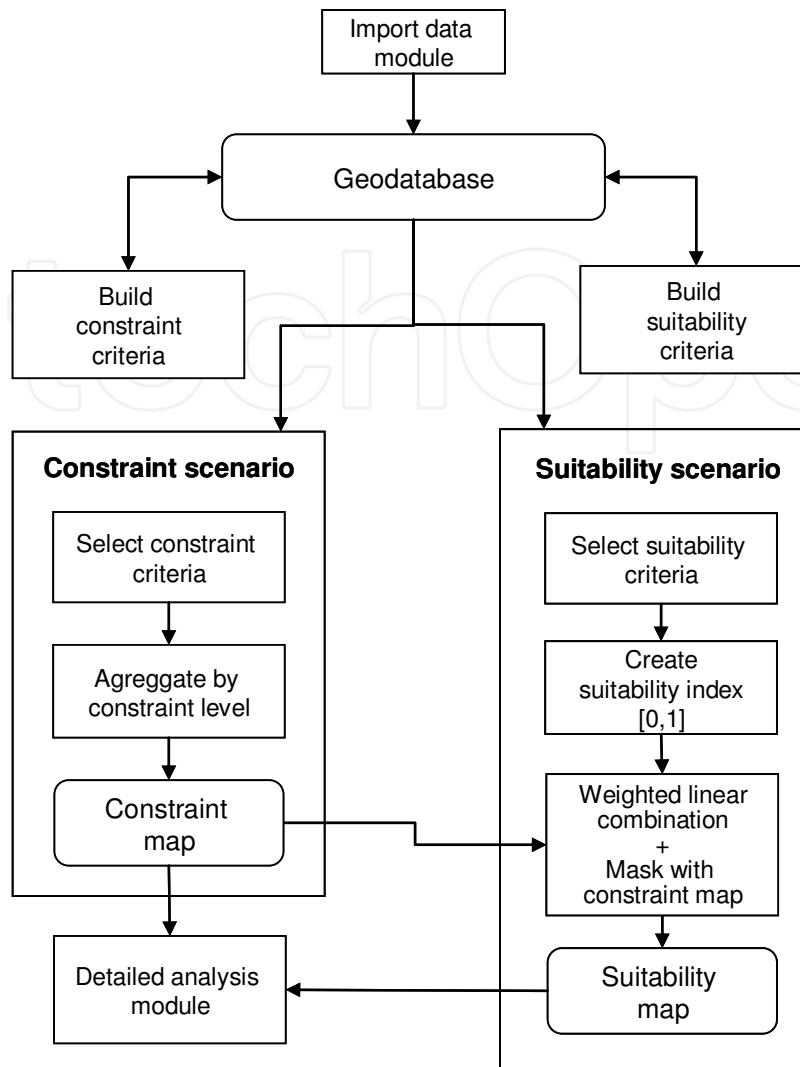

Fig. 2. Structured approach used in the decision-making aid system.

3.2.2 Translation of criteria into map format

- *Constraint Criteria*

The constraint criteria are converted into map format by using one of the following geoprocessing operations:

- The constraint zone is created by copying into a new layer the surface features in relation to the specific constraint identified beforehand;
- The constraint zone corresponds to a buffer zone drawn around the features in relation to which the constraint is identified. The use of this second representative mode reflects the fact that the nuisance or risk linked to any given constraint is present in the proximity of the feature and decreases as the feature's distance from the wind turbine increases.

Buffer zone distances are determined according to the likely impacts of the corresponding hazards and nuisances. Certain distances were based on objective technical considerations (e.g. distance from a railway track in relation to maximum height of turbine blades). Other distances were determined based on an educated guess, e.g. visual impact addressed by certain landscape criteria. In particular, the tools described below can be used to test the

sensitivity of the final constraints map to some ranges of distances determining buffer zones addressed by certain criteria.

Basic thematic maps used to establish criteria are retrieved as vector layers, whereas layers including constraint criteria were produced in raster mode. This choice was governed by the large number of criteria used in producing the composite map.

Three constraint levels were identified, with each constraint criterion being linked to one of following levels:

- *Exclusion*: the set up of wind turbines should be prohibited;
 - *Highly sensitive*: although wind turbines set up is theoretically prohibited, a derogation may be granted as long as an impact appraisal brings convincing evidences that the constraint does not exist at the specific location proposed for the wind turbine set up;
 - *Sensitive*: authorization for building a wind turbine is conditional upon a detailed impact appraisal of the specific constraint.
- *Suitability Criteria*

The creation of factor maps showing suitability indexes can be based on two different approaches (figure 3): (i) a raster layer is built by computing the Euclidian distance from the features described in a vector layer, and the membership function is applied to the distance stored in each grid cells; (ii) the membership function is applied to a quantitative attribute associated to a polygon vector layer, and the this vector layer is then converted into a raster layer using the value of the newly created attribute. The membership functions are linear and defined by four control points a, b, c, d (figure 4).

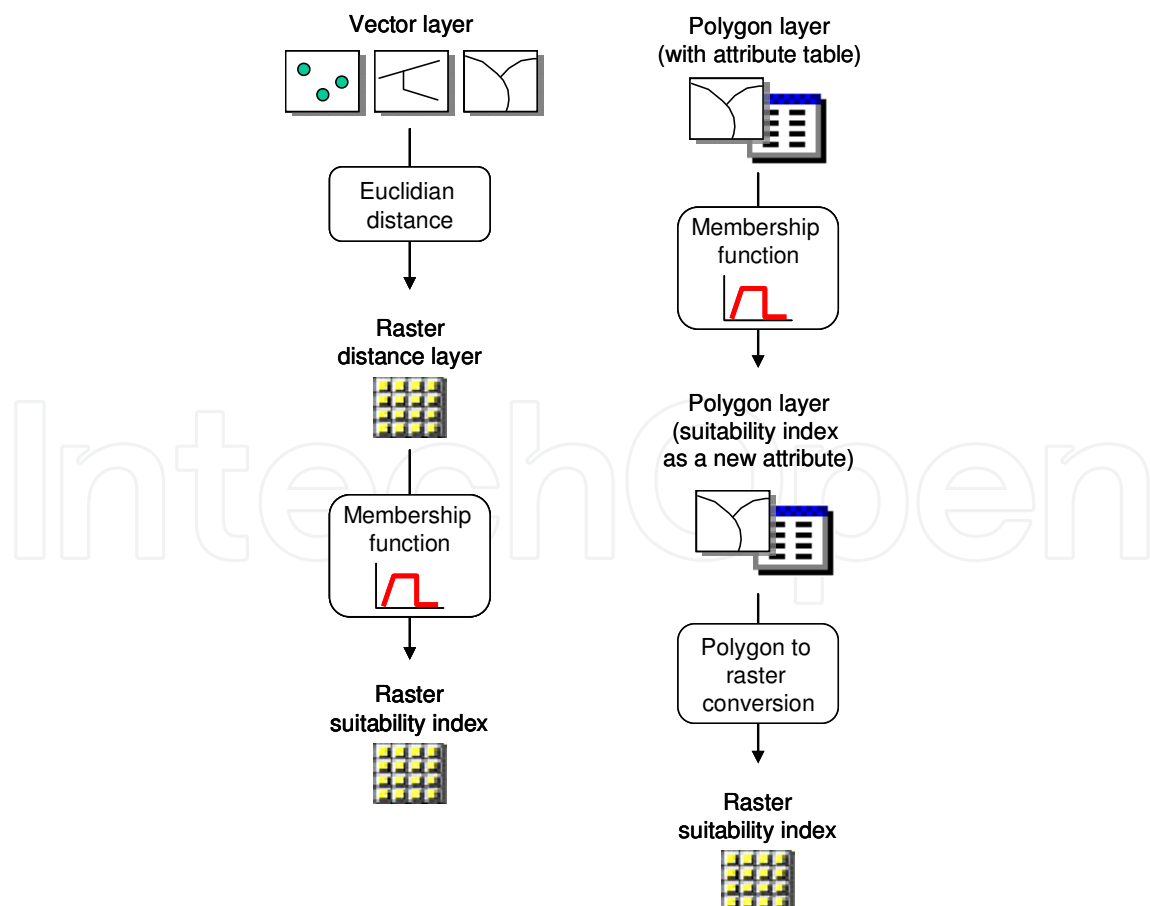

Fig. 3. Description of two approaches used to build suitability index maps.

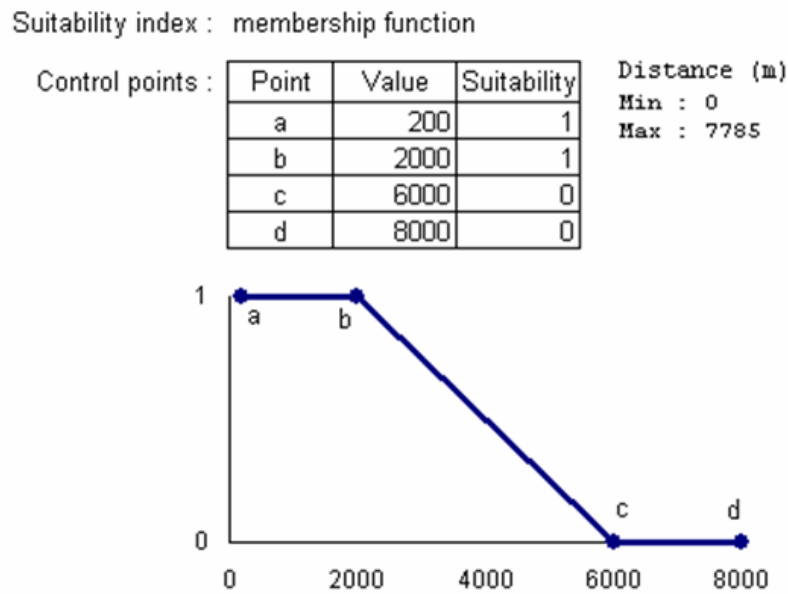

Fig. 4. Membership function used to convert a suitability criterion (in this example, the distance to the nearest high voltage power line is given in meters) into a suitability index.

3.2.3 Criteria aggregation

- *Constraint Criteria*

Composite constraint maps are produced in two stages. The first stage involves aggregating criteria by level of constraint, while the second stage involves applying the highest level of constraint to each pixel of the general map. The database also contains intermediate maps which show - for each pixel - the number of criteria per level of constraint, or the clustered pixel area for a given level of constraint.

On the one hand, the Boolean cluster model used in this study offers a low level of flexibility (Hansen, 2005; Hossain et al., 2003). On the other hand, this weakness is balanced by the existence of three levels of constraint. Moreover, an analysis module has been added to draw up a diagnosis for each wind turbine in a wind farm project in relation to all the constraint criteria (see next section).

- *Suitability Criteria*

The aggregation of suitability indexes uses weighted linear combination. In addition, an option is given to mask the suitability map using the exclusion criteria of a constraint scenario (eq 1).

$$S_k = \left(\sum_{j=1}^n w_j x_{j,k} \right) \cdot \prod_{i=1}^m c_{i,k} \quad (1)$$

where:

S_k : suitability index for pixel k,

n : number of suitability criteria,

m : number of constraint criteria,

w_j : weight for the j suitability criteria,

$x_{j,k}$: value of the suitability index j in the pixel k,

$c_{i,k}$: value (0-1) of the constraint criteria i (with exclusion level) in the pixel k.

3.3 SDSS development

Once the preliminary constraint map production tests had been finalised and discussed with the regional planning authority, it became clear that the management of such a large number of constraint criteria had to be based on specific GIS modelling tool if it was to be used and evolve efficiently. For instance, this tool had to be used to test the sensitivity of the results in relation to certain criteria, the definition of which was partly subjective. Indeed, such criteria are likely to be adjusted in the near future. This first phase of constraint definition was originally subject to an optional review of and an analysis on areas suitable for wind farms set up.

The tool concept lies on four pillars:

- A geodatabase where the bulk of cartographic data is stored and managed, including input layers, transformed data and output data, i.e. results;
- A relational database used to retrieve criteria features, constraints regarding carrying capacity as well as scenario parameters connecting criteria;
- A set of computing modules running data management and processing;
- A user-friendly interface.

The system functions on the basis of scenarios. A scenario is defined as a specific set of constraint criteria and/or suitability criteria over a given area used as a mask. Criteria are defined on the basis of a data source, i.e. input layer and a series of parameters, e.g. constraint levels, buffer distance, membership function, etc. It conveniently allows sensitivity analyses, i.e. assessing how results respond to a change in value of a specific criterion while other criteria remain unchanged.

In order to ease its access by various stakeholders involved in the decision-making process, the tool has been developed using an open source GIS platform. The software GRASS (Neteler & Mitasova, 2008) has been retained. GRASS features a solid library of management functionalities including spatial data analyses (Ramsey, 2007; Dunsford & Ames, 2008). Another open-source software, namely QGIS, has been used as the companion tool of GRASS, more particularly for its cartographic data display capability (Sherman, 2008).

Most often, original spatial data are available in ESRI shapefile format. A specific module enables those data to be imported as GRASS formatted data. Similarly, a data export module enables other GIS software to access resulting maps / output layers.

The relational database is retrieved as a Microsoft Access file. It is used to store criteria definitions, including the values of the related parameters, together with the main quantified results linked to the resulting composite maps produced, e.g. areas related to each constraint level, etc. Figure 5 illustrates the simplified structure of the geodatabase as well as its links with the relational database.

The various geoprocessing steps used to create criteria grids as well as the aggregation of these grids to produce some composite maps were based on a collection of Grass modules. The interface used to manage all those functionalities has been developed in VBA language and built up inside an Excel workbook (figure 6).

The software application is also featured with a module that allows a comprehensive diagnosis of either a current or a prospective wind turbine project regarding a constraint or suitability scenario. This diagnosis results in a map where a point layer with the accurate location of wind turbines overlay the composite map related to the scenario envisaged. This map also relates to a table where all criteria used in the specific scenario are characterized in

regard of each single turbine. As far as constraint criteria are concerned, the distance to the nearest constraining feature is also approximated.

4. Results

A map summarizing all possible constraints relevant to wind farm set up in Wallonia has been drawn taking into account 40 criteria categorised into three constraint levels.

As evidenced by a test made with a machine powered by a single core processor (Pentium 4-Prescott 3.0 GHz), it takes 63 minutes to run a scenario involving all the 40 criteria. This time corresponds to the following operations: creation of criteria grids, aggregation of composite grids, calculation of results, i.e. areas and retrieving the results into the relational database.

The creation of a diagnosis report for a specific site with 10 wind turbines requires a computing time of about 9 minutes. Figure 7 presents the composite map based on the criteria selected by the group of experts empowered by the regional authority for supervising the study. Constraint-free areas represent 4.94% of the region, i.e. 836 km².

Figure 8 gives an example of a sensitivity analysis on the criterion addressing the distance between turbines and housing areas. It is noteworthy that this buffer distance is used as a noise nuisance criterion and is assigned an "exclusion" constraint level. A 350 m-distance was taken into account in the scenario presented in figure 7. Excluded areas, i.e. within a 350 m-distance from housing areas, increase from 53.9%, i.e. 9,111 km² to 85.0%, i.e. 14,375 km² when the buffer to housing areas increased from 350 m to 1,000 m. As a distance of 1,000 m is used, the total constraint-free area falls below 2.8% of the total land area, i.e. 463 km².

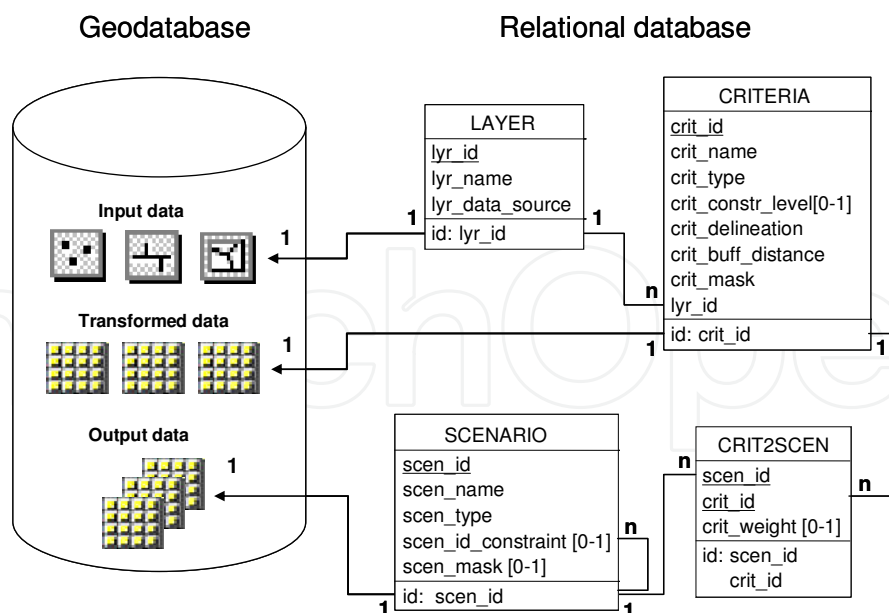

Fig. 5. Descriptive scheme of the relational database and its connection with the geodatabase. Input data are vector layers whereas transformed and output data are stored as raster grids. One grid corresponds to each criterion while a composite grid refers to each specific scenario.

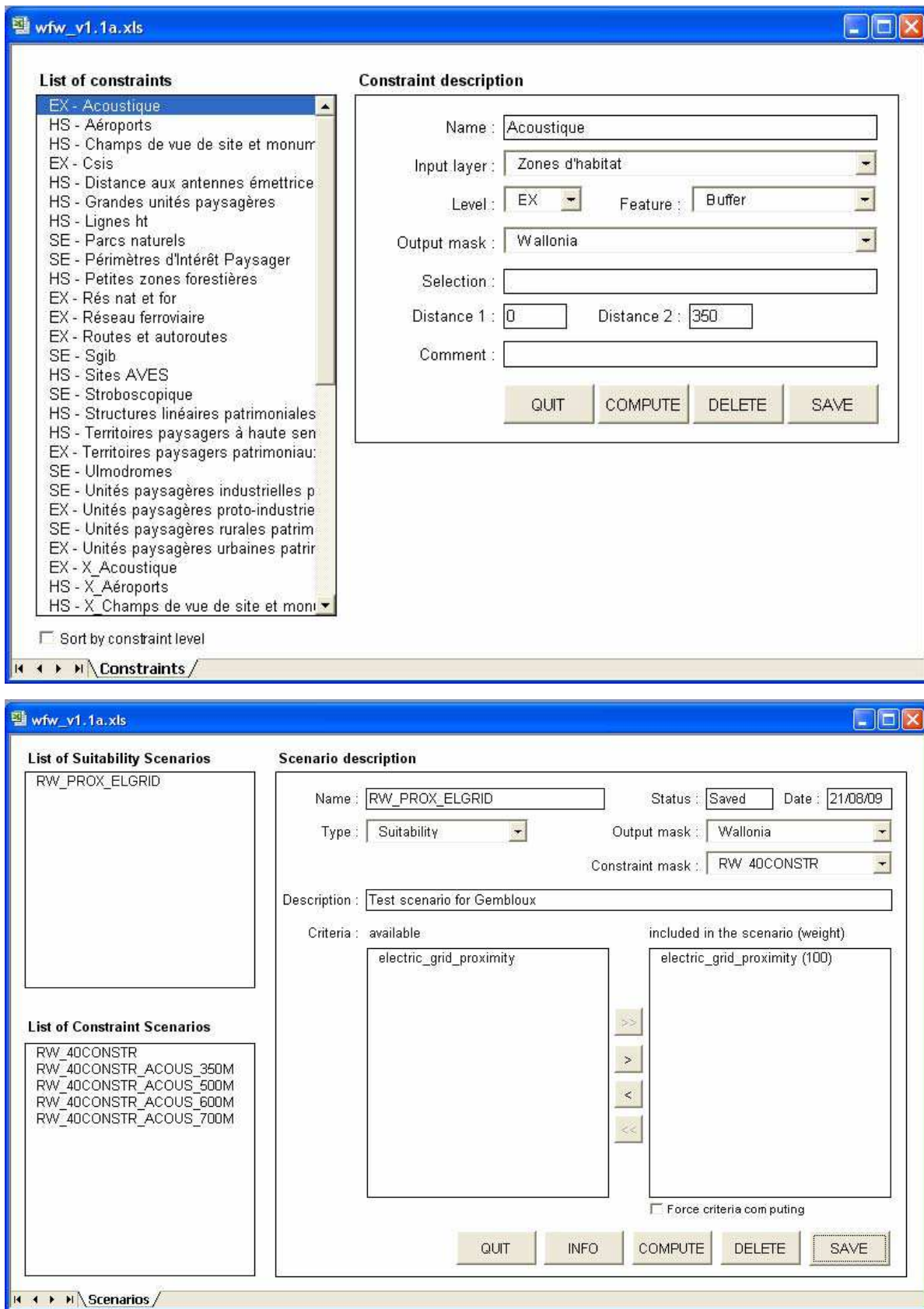

Fig. 6. Example of interfaces developed in Excel environment, which was found convenient to run the system functionalities.

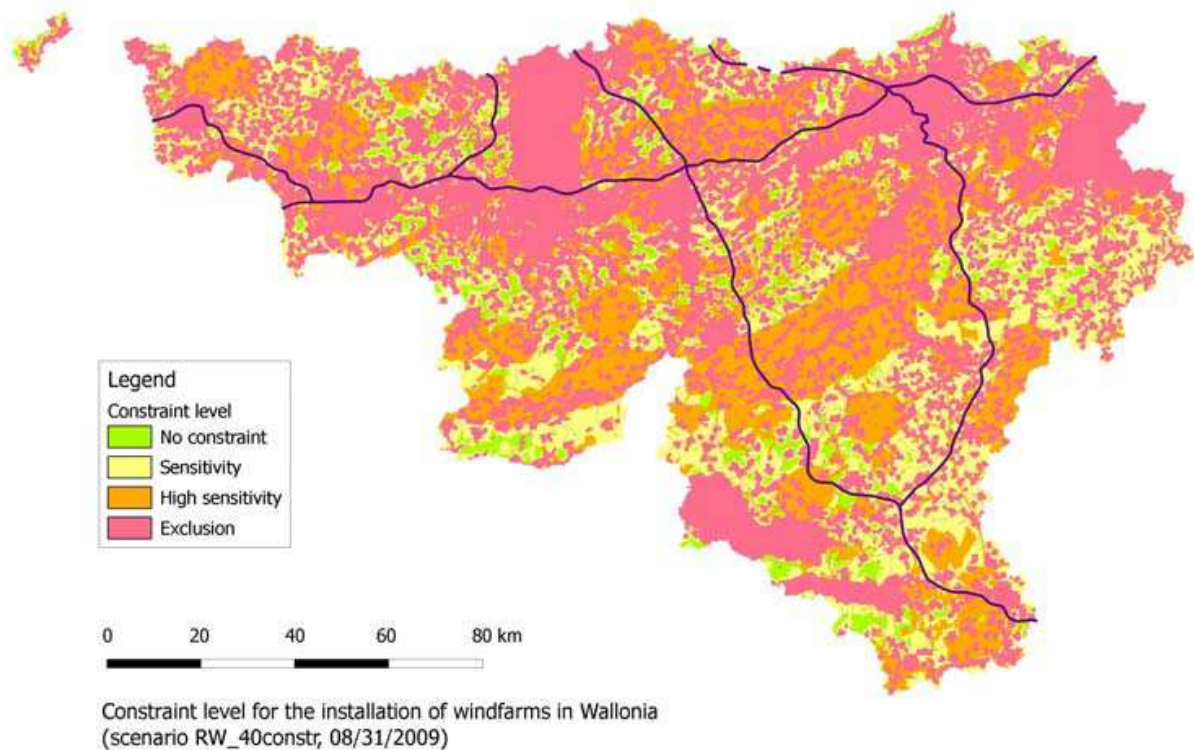

Fig. 7. Composite map for the Walloon region showing the constraint levels for the installation of wind farm projects (scenario based on the criteria definitions given in Appendix 1).

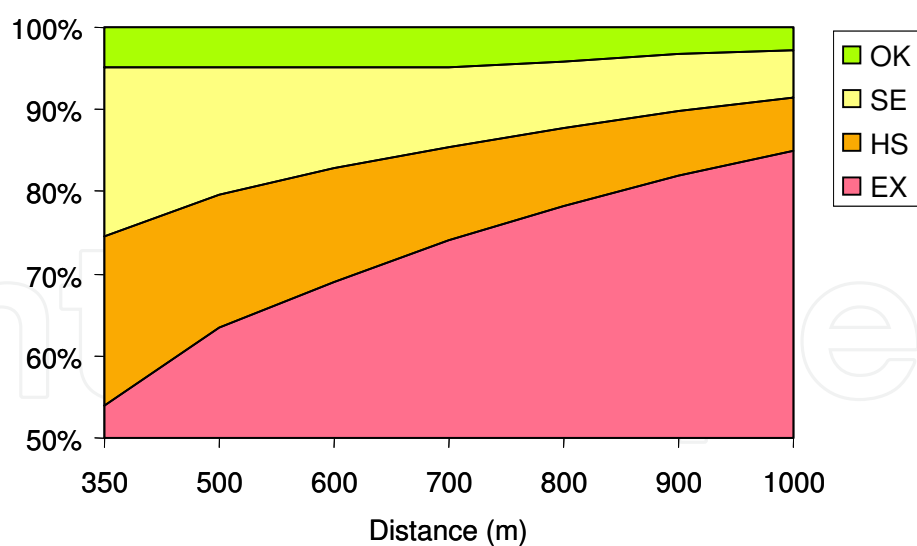

Fig. 8. Impact of an increase in the distance between turbines and housing areas in relation with the noise nuisance criterion on the area - expressed as a % of the region - devoted to each constraint level, i.e. EX: exclusion, HS: highly sensitive, SE: sensitive, OK: no constraint.

Figure 9 shows the results derived from a suitability scenario where two suitability indexes of even weights were combined. The first suitability index expresses a distance between the wind turbines and the power grid whereas the second index expresses the distance to

housing areas. Excluded areas, i.e. areas conflicting with either each or both constraints, derived from the constraint map given in figure 6 have been masked.

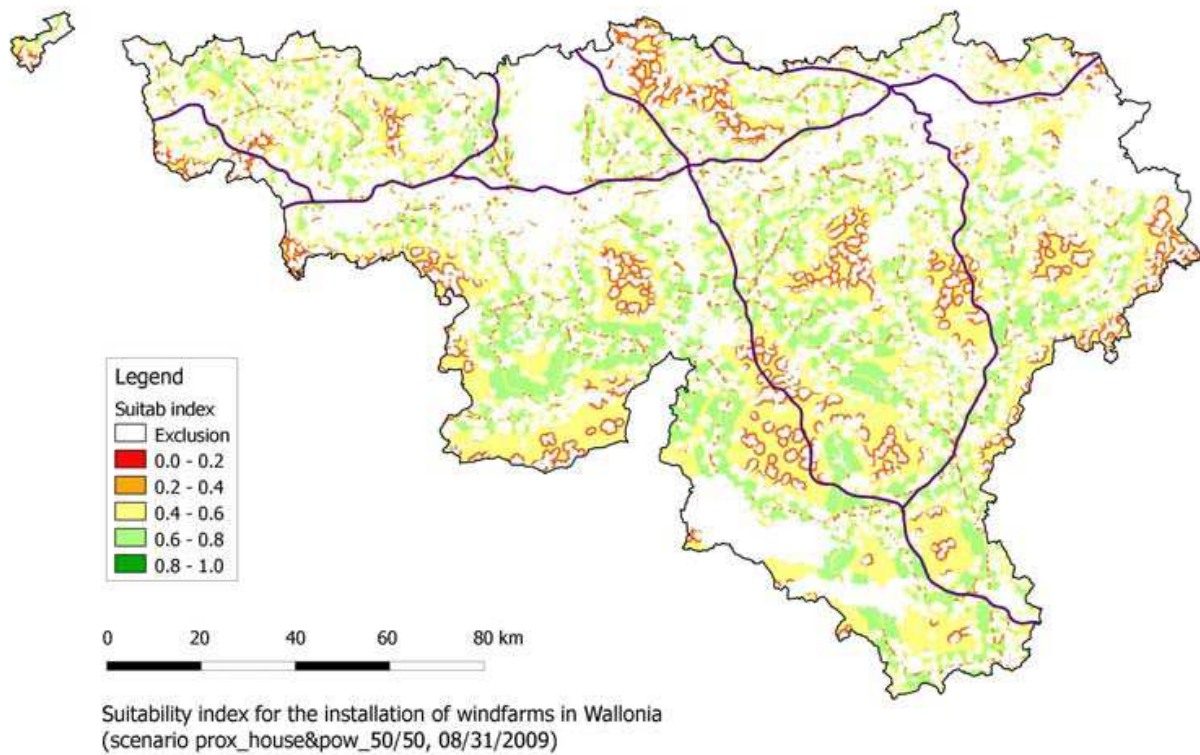

Fig. 9. Map describing a suitability scenario including a criterion relevant to the distance to high voltage power lines (weight = 50) and another criterion relevant to the distance to housing areas (weight = 50). This scenario also includes the mask corresponding to the exclusion constraint given in figure 7.



Fig. 10. Overlay of the location of a wind farm project and the composite constraints map.

Figure 10 shows the overlay of a wind farm project and the constraint map. Table 1 illustrates the section of the analysis report for this wind farm project that relates to environmental constraint criteria. This report accurately identifies which criteria is responsible for the determination of a constraint level with regard to each specific wind turbine. It also provides turbine specific information on the distances to the nearest features impacted by the various criteria.

Criteria		Turbine id											
		1		2		3		4		5		6	
		CL	DIST	CL	DIST	CL	DIST	CL	DIST	CL	DIST	CL	DIST
Environmental	SPA		> 10		> 10		> 10		> 10		> 10		> 10
	N2000		2.92		3.30		2.69		2.45		2.28		2.08
	BIRDS		6.53		6.24		6.74		6.98		7.16		7.38
	RES		> 10		> 10		> 10		> 10		> 10		> 10
	CSIS		9.48		8.94		9.79		9.64		9.55		9.43
	CZLPND		8.29		8.93		7.93		7.83		7.76		7.69
	ZHIB		> 10		> 10		> 10		> 10		> 10		> 10
	SHBV		2.01		1.74		2.25		2.48		2.45		2.22
	AIRP		> 10		> 10		> 10		> 10		> 10		> 10
	ALR		5.22		4.91		5.41		5.67		5.85		6.07
	MLR		> 10		> 10		> 10		> 10		> 10		> 10
	ACOU		0.79	EX	0.00		1.16		1.17		1.04		0.88
	FLICK		0.79		0.16		1.16		1.17		1.04		0.88
	HVL		0.49		0.32		0.57		0.29	HS	0.10	HS	0.13
	ROAD		0.47		0.20		0.15		0.17		0.18		0.18
	RAIL		4.93		4.52		5.18		4.98		4.85		4.69
	GREEN		0.61		0.89		0.48		0.76		0.96		1.20
	NAT		6.29		5.95		6.52		6.76		6.93		7.06
	PARC		3.10		2.64		3.39		3.21		3.10		2.97
	CPWPZ		6.65		6.20		6.93		7.14		7.16		6.95
RPWPZ		2.96		3.63		2.58		2.59		2.59		2.59	
LSL		> 10		> 10		> 10		> 10		> 10		> 10	
IKR		> 10		> 10		> 10		> 10		> 10		> 10	
KR		> 10		> 10		> 10		> 10		> 10		> 10	
ANT		8.17		7.51		8.54		8.48		8.46		8.44	

CL (Constraint level): EX = Exclusion, HS = Highly sensitive, SE = Sensitive

DIST: Distance (km) to the nearest constraint feature

Table 1. Extract from a detailed analysis report for a wind farm project

5. Conclusions and outlook for further development

The SDSS described in this chapter is designed to manage some cartographic layers relevant to analyzing constraints and potential of Walloon wind farm development in a straightforward and well-structured fashion.

The various computing interfaces above-mentioned allow laymen, i.e. operators who do not have expert knowledge of geoprocessing and database management systems, to generate and analyze scenarios under various constraints pertaining to areas conducive to wind farms set up either at the entire region level or in some specific study areas.

The functionalities that have been developed in the GIS open-source GRASS and QGIS environment contrast with a previous tool developed with a commercial GIS platform (Lejeune & Feltz, 2008). These functionalities have proven efficient enough and may substitute for other commercial and relatively expensive products.

Two features such as simplicity and accessibility make this project promising with a view of a greater involvement of stakeholders concerned with wind power development in Wallonia.

Bearing in mind that such analytical tools, both user-friendly and highly accessible, are today available and in line with the multi-criteria nature of the problem, it is anticipated that the next step in wind power policy planning shall imply the set up of genuine participatory process (Rauschmayer & Wittmer, 2006 ; Stagl, 2006 ; Gamboa & Munda, 2007). Many issues still need to be addressed at that level and there is much room for further improvement, e.g. who should the stakeholders' representatives be, when and how to initiate their involvement in the decision-making process, how should the decision-making process be structured, i.e. from regional planning to local project appraisal, etc. Many pending questions remain today unanswered.

6. References

- Baban, S. M. J. & Parry, T. (2001). Developing and applying a GIS-assisted approach to locating wind farms in the UK. *Renewable Energy*, 24, 59-71
- Brans, J.P.; Vincke, Ph. & Mareschal, B. (1986). How to select and how to rank projects: the PROMETHEE method. *European Journal of Operational Research* 24: 228-238.
- Cavallaro, F. & Ciraolo, L. (2005). A multicriteria approach to evaluate wind energy plants on an Italian Island. *Energy Policy*, 33, 235-244
- Chang, N.-B.; Parvathinathan, G. & Breeden, J. B. (2008). Combining GIS with fuzzy multicriteria decision-making for landfill siting in a fast-growing urban region, *Journal of Environmental Management*, 87, 139-153
- Econotec Consultants. (2009). Projet d'actualisation du Pland pour la Maîtrise Durable de l'Energie (PMDE) en Wallonie à l'horizon 2020. *Service Public de Wallonie DG04 Département de l'Energie et du Bâtiment durable*. 307p.
- Dunsford, H.A. & Ames D.P. (2008). An extensible, Interface-Based, Open Source GIS Paradigm: MapWindow 6.0 Developer Tools for the Microsoft Windows Platform. *Proceedings of the academic track of the 2008 free and Open Source Software for Geospatial (FOSS4G) conference, incorporating the GISSA Conference*, pp. 14-22, ISBN 978-0-620-42117-1, Cape Town, 29 September – 3 October, South Africa
- Eastman, R.; Kyem, P. & Toledno, J. (1993). A procedure for multiple-objective decision making in GIS under conditions of conflicting objectives. In: J. Hents, H. Ottens and

- H. Scholten (Eds). *4th European Conference on GIS (ESIG'93)*, Estoril, Portugal, 10–12 November 1993, (EGIS foundation, Utrecht/ Amsterdam), Vol. 1, pp. 439–447.
- GWEC. (2008). *Global wind 2008 report*. Available at http://www.gwec.net/fileadmin/documents/Global_Wind_2008_Report.pdf
- Feltz, C.; Droeven, E. & Kummert, M. (2003). Les territoires paysagers de Wallonie. Etude et documents, CPDT 4. *Division de l'Observatoire de l'Habitat [D.O.H.]*, Namur
- Feltz, C. ; Lejeune, P.; Cuvelier, M. & Schaar, C. (2004). Plan éolien wallon et Paysage. *Les Cahiers de l'Urbanisme*, 52, 15-23
- Gamboa, G. & Munda, G. (2007). The problem of windfarm location: A social multi-criteria evaluation framework. *Energy Policy*, 35, 1564-1583.
- Hansen, H. (2005). GIS-based Multi-Criteria Analysis of Wind Farm Development. *Proceedings of the 10th Scandinavian Research Conference on Geographical Information Science (ScanGIS)*, pp. 75-85, ISBN: 91-7323-126-6, Stockholm, Sweden, 13-15 June 2005, Department of Planning and Environment, Stockholm. Available at http://vbn.aau.dk/ws/fbspretrieve/1420302/Henning_ScanGIS_2005.pdf
- Hossain, H.; Hood, A.; Sposito, V. & Cook, S. (2003). Strategic Regional Planning: mixing data, experts and GIS, *ESRI*
- Joerin, F.; Thériault, M. & Musy., A. (2001). Using GIS and Outranking Multicriteria Analysis for Land-use Suitability Assessment. *International Journal of Geographical Information Sciences*, Vol. 15, No. 2, 153-174
- Kangas, A.; Kangas, J. & Kurttila, M. (2008). *Decision Support for Forest Management*. Springer Science + Business Media B.V., ISBN 978-1-4020-6786-0, The Netherlands
- Lejeune, P. & Feltz C. (2008). Development of a decision support system for setting up a wind energy policy across the Walloon Region (southern Belgium). *Renew Energy*. 33, pp. 2416 - 2422.
- Ministry for the Walloon Region (2002). Cadre de référence pour l'implantation d'éoliennes en Région wallonne. *DGATLP*, Namur
- Neteler, M. & Mitasova, H. (2008). *Open Source GIS A Grass GIS Approach*. Springer Science+Business Media, LLC, ISBN-13: 978-0-387-35767-6, New York, USA
- Ramsey, P. (2007). The State of Open Source GIS. *Refractions Research*, 49p.
- Rauschmayer, F. & Wittmer, H. (2006). Evaluating deliberative and analytical methods for the resolution of environmental conflicts. *Land Use Policy*, 23, 108-122
- Rodman, L.C. & Meentemeyer R.K. (2006). A geographic analysis of wind turbine placement in Northern California. *Energy Policy*, 34, 2137-2149
- Roy, B. (1991). The outranking approach and the foundations of Electre methods. *Theory and Decision* 31: 49–73.
- Sherman, G. (2008). *Desktop GIS: Mapping the Planet with Open Source Tools*. The Pragmatic Programmers Ed., ISBN-13: 978-1-934356-06-7, USA
- Sparkes, A. & Kindner, D. (1996). A GIS for the Environmental Impact Assessment of Wind Farms, *ESRI*
- Stagl, S. (2006). Multicriteria evaluation and public participation: the case of UK energy policy. *Land Use Policy*, 23, 53-62
- Zadeh, L.A. (1965). Fuzzy Sets. *Information and Control*, 8, 338–353
- Zucca, A.; Sharifi, A.M. & Fabbri A. G. (2008). Application of spatial multi-criteria analysis to site selection for local park: A case study in the Bergamo Province, Italy. *Journal of Environmental Management*, 88, 752-769

Appendix 1a – list of the selected ‘environmental’ constraint criteria

Category	ID	Criteria	Alias	Reference features	Constraint level	Geo processing	Buffer zone (m)
Environmental	1	Special Protection Area	SPA	Polygon	EX	feature	
	2	Natura 2000 sites	N2000	Polygon	SE	feature	
	3	Site of ornithological value	BIRDS	Polygon	HS	buffer	150
	4	Nature Reserve	RES	Polygon	EX	feature	
	5	Underground cavity of scientific interest	CSIS	Point	EX	buffer	100
	6	Central zones of Local Plan for Nature Development	CZLPND	Polygon	EX	feature	
	7	zhib	ZHIB	Polygon	EX	feature	
	8	Site of high biological value	SHBV	Polygon	SE	feature	
	9	Airports	AIRP	Polygon	HS	buffer	5000
	10	Airplane landing runway	ALR	Point	HS	feature	
	11	Microlight landing runway	MLR	Point	SE	buffer	2000
	12	Acoustic effect	ACOU	Polygon	EX	buffer	350
	13	Zone of potential flicker effect	FLICK	Polygon	SE	buffer	700
	14	High voltage lines	HVL	Line	HS	buffer	150
	15	Proximity to roads	ROAD	Line	EX	buffer	40
	16	Proximity to railroad	RAIL	Line	EX	buffer	40
	17	“Green” parks	GREEN	Polygon	EX	feature	
	18	Area devoted to nature	NAT	Polygon	EX	buffer	200
	19	Parks	PARK	Polygon	EX	feature	
	20	Close protection of water producing zone	CPWPZ	Polygon	EX	feature	
	21	Remote protection of water producing zone	RPWPZ	Polygon	SE	feature	
	22	Landslide risk	LSL	Polygon	EX	feature	
	23	Area with important karstic risks	IKR	Polygon	EX	feature	
	24	Area with karstic risks	KR	Polygon	SE	feature	
	25	Risk of interference with radio antenna	ANT	Polygon	HS	buffer	600

Appendix 1b – list of the selected ‘landscape’ constraint criteria

Category	ID	Criteria	Alias	Reference features	Constraint level	Geo processing	Buffer zone (m)
Landscape	26	Heritage landscapes	PL	Polygon	EX	feature	
	27	Highly sensitive landscapes & territories	HSLT	Polygon	HS	feature	
	28	Small wood lots	SWL	Polygon	HS	feature	
	29	Hilly forests	HF	Polygon	HS	feature	
	30	Forest with recreational value	FRV	Polygon	HS	feature	
	31	Nature parks	NP	Polygon	SE	feature	
	32	Large common rural landscapes	LCRL	Polygon	HS	feature	
	33	Proto-industrial landscape units	PILU	Polygon	EX	feature	
	34	Industrial landscape units with heritage value	ILPV	Point	SE	buffer	2000
	35	Urban landscape units with heritage value	ULPV	Point	EX	feature	
	36	Rural landscape units with heritage value	RLPV	Polygon	SE	buffer	2000
	37	Linear features with heritage value	LFPV	Line	HS	buffer	1250
	38	Viewshed of classified monuments	VCM	Polygon	HS	feature	
	39	Zones of landscape value	ZLV	Polygon	SE	feature	
	40	Perimeter of landscape value	PLV	Polygon	SE	feature	



Decision Support Systems Advances in

Edited by Ger Devlin

ISBN 978-953-307-069-8

Hard cover, 342 pages

Publisher InTech

Published online 01, March, 2010

Published in print edition March, 2010

This book by In-Tech publishing helps the reader understand the power of informed decision making by covering a broad range of DSS (Decision Support Systems) applications in the fields of medical, environmental, transport and business. The expertise of the chapter writers spans an equally extensive spectrum of researchers from around the globe including universities in Canada, Mexico, Brazil and the United States, to institutes and universities in Italy, Germany, Poland, France, United Kingdom, Romania, Turkey and Ireland to as far east as Malaysia and Singapore and as far north as Finland. Decision Support Systems are not a new technology but they have evolved and developed with the ever demanding necessity to analyse a large number of options for decision makers (DM) for specific situations, where there is an increasing level of uncertainty about the problem at hand and where there is a high impact relative to the correct decisions to be made. DSS's offer decision makers a more stable solution to solving the semi-structured and unstructured problem. This is exactly what the reader will see in this book.

How to reference

In order to correctly reference this scholarly work, feel free to copy and paste the following:

Philippe Lejeune, Thibaut Gheysen, Quentin Ducenne and Jacques Rondeux (2010). Development of an Open Source GIS Based Decision Support System for Locating Wind Farms in Wallonia (Southern Belgium), Decision Support Systems Advances in, Ger Devlin (Ed.), ISBN: 978-953-307-069-8, InTech, Available from: <http://www.intechopen.com/books/decision-support-systems-advances-in/development-of-an-open-source-gis-based-decision-support-system-for-locating-wind-farms-in-wallonia>

INTECH
open science | open minds

InTech Europe

University Campus STeP Ri
Slavka Krautzeka 83/A
51000 Rijeka, Croatia
Phone: +385 (51) 770 447
Fax: +385 (51) 686 166
www.intechopen.com

InTech China

Unit 405, Office Block, Hotel Equatorial Shanghai
No.65, Yan An Road (West), Shanghai, 200040, China
中国上海市延安西路65号上海国际贵都大饭店办公楼405单元
Phone: +86-21-62489820
Fax: +86-21-62489821

© 2010 The Author(s). Licensee IntechOpen. This chapter is distributed under the terms of the [Creative Commons Attribution-NonCommercial-ShareAlike-3.0 License](#), which permits use, distribution and reproduction for non-commercial purposes, provided the original is properly cited and derivative works building on this content are distributed under the same license.

IntechOpen

IntechOpen